

# **railbookers**

## CANADA BY RAIL



2024  
2025

# VIA RAIL NETWORK

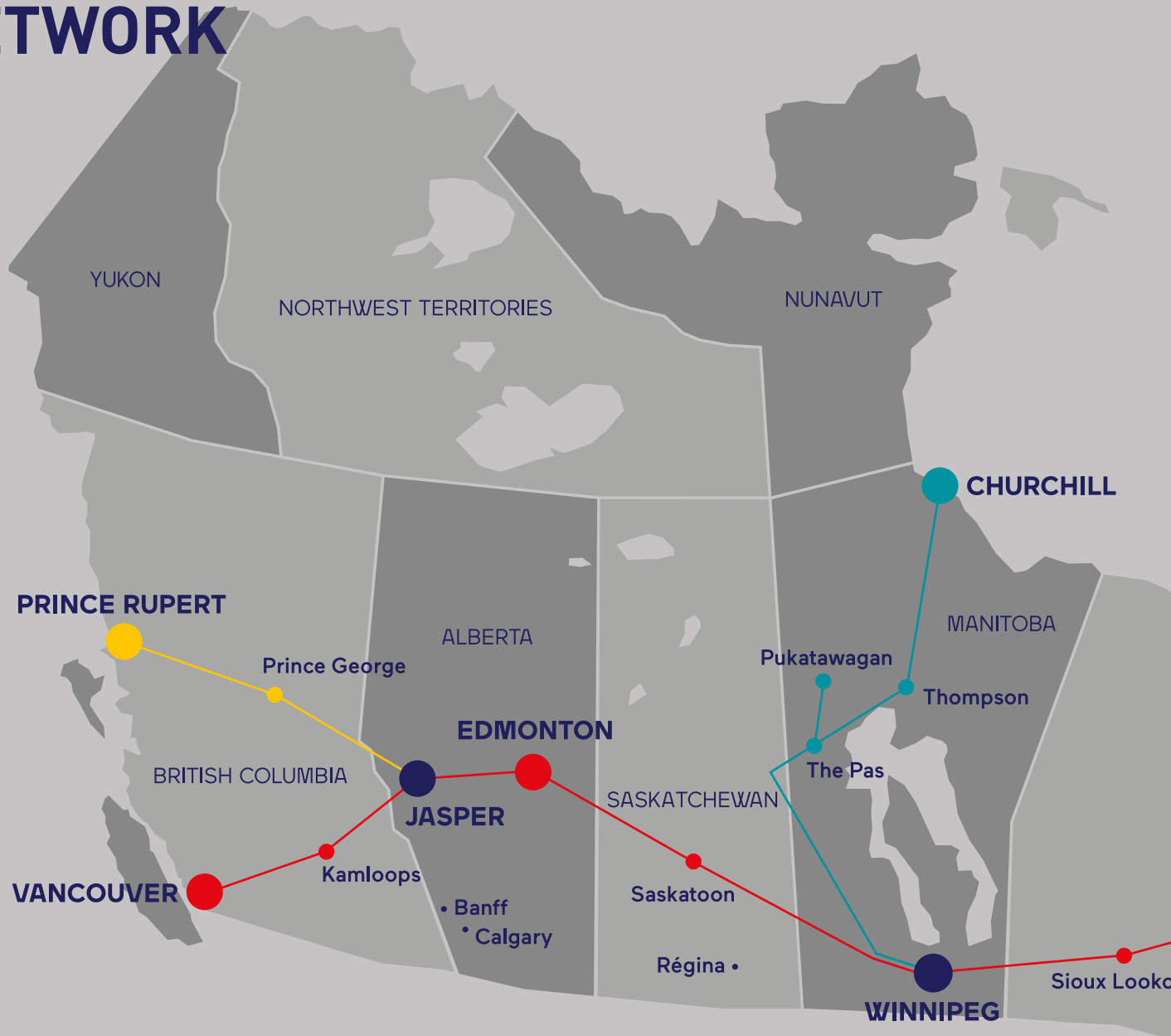

- *The Canadian*
- Jasper - Prince Rupert
- Winnipeg - Churchill
- White River - Sudbury
- Montreal - Senneterre  
Montreal - Jonquiere
- *The Ocean*
- Corridor

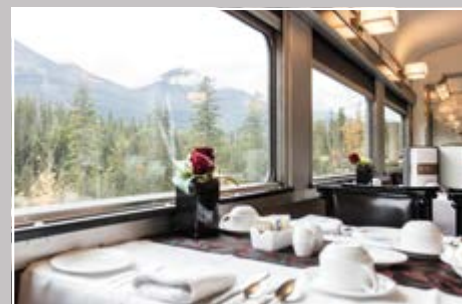



# WHY RAILBOOKERS?

Railbookers offers expertly planned tailor made vacations with an extensive range of trips to North America, Europe and beyond.

We take the complexity out of independent rail travel and offer all our customers unparalleled service, incredible travel experiences and the very best value. The team at Railbookers is made up of proud 'train geeks' with comprehensive knowledge and passion for all things rail.



Vancouver



## RAIL EXPERT KNOWLEDGE

We know rail; from the best routes to the best times ensuring you have the best vacation.



## MAXIMUM FLEXIBILITY

Any destination, any date for any length of time... simply put, if the train goes there, so do we.



## BOOK AND TRAVEL FROM TODAY TO 2 YEARS AHEAD

You can depart today or book your bucket-list trip 2 years ahead; either way, we have you covered.



## NO RAIL TRIP IS TOO COMPLICATED FOR US

What is confusing is our easy and anything can be customized.



## LARGEST RAIL VACATION SELECTION

From luxurious, multi-country journeys to extending your cruise, or creating a tailor made rail itinerary, we have it all.



## CONTENTS

Why Railbookers?	4
Everything you need to know about your rail vacation	7
<b>CANADA</b>	<b>8-9</b>
<b>WESTERN AND CENTRAL CANADA</b>	
Ultimate Canada and Rockies Westbound	10-11
Classic Canada and Rockies Eastbound	12-13
Canadian Rockies Discovery Eastbound	14-15
Grand Circle of the Canadian Rockies	16-17
Canadian Rockies and Coast Journey	18-19
Canadian Rockies Adventure	20
Western Canada and the Canadian Rockies	21
Trans Canada and Rockies Adventure with Rocky Mountaineer	22-23
<b>WINTER JOURNEYS</b>	
Canadian Rockies Winter Discovery Eastbound	24
Classic Canada and Canadian Rockies in Winter	25
<b>TRANS CANADA</b>	
Canadian Rail Experience - Toronto To Vancouver	26-27
Ultimate Canada Coast to Coast	28-29
Grand Eastern Canadian Rail Journey	30-31
<b>EASTERN CANADA</b>	
Quebec and the Maritimes Rail Journey	32-33
Quebec City and Halifax from Montreal	34
Ultimate Quebec City and Halifax from Toronto	35
Eastern Canada Rail Journey	36-37
<b>INFORMATION</b>	
VIA Rail Accommodations	38-39

## OUR RAIL PARTNERS







# EVERYTHING YOU NEED TO KNOW ABOUT OUR VACATIONS

## HOW DO I MAKE A RESERVATION?

Call Railbookers **1-888-829-3040** to speak with one of our knowledgeable Rail Experts to book your perfect rail vacation, call your local travel agent or visit our website to submit an online request at [www.railbookers.com](http://www.railbookers.com)

## WHAT INFORMATION DO YOU REQUIRE AT THE TIME OF BOOKING?

All passenger first and last names, and all dates of birth, are required at the time of booking. Certain train providers will require passport information.

## CAN I CUSTOMIZE MY TRIP?

Absolutely. We can add hotel nights to give you extra time to explore your destination, or add in additional destinations to help you discover new ones! We can also add transfers for ultimate ease and convenience and have an extensive range of sightseeing options so you can make the most of your trip. Just speak with our Rail Experts and we'll start creating the perfect rail vacation for you.

## CAN YOU RECOMMEND THE MOST SCENIC ROUTE TO GET TO MY DESTINATION?

We're always advocates of taking the scenic route! With so much to see from the train windows on all our rail vacations, you're in for a treat. If there's a different route you could take for some extra special scenery, we'll be excited to let you know!

## CAN I UPGRADE TO FIRST-CLASS RAIL ON SOME OR EVEN ALL OF MY TRAIN JOURNEYS?

You certainly can. We know that many of our customers like to upgrade some or all of their train journeys to first-class. Upgrading will give you a larger seat, more legroom and even a meal and drinks on certain routes. To find out more, please speak with one of our Rail Experts who will tell you the advantages of first class on your specific route.

## CAN I TAKE A RAIL VACATION THAT YOU OFFER IN REVERSE?

Yes! We can offer a reverse option on any of our itineraries. If you are already planned to be in one destination and would like to visit cities on one of our packages in a different order or start/finish in a different location, please call us and speak with a Rail Expert.

## WHERE ARE YOUR HOTELS LOCATED?

Our hotels are centrally located within each city we offer. Most are within a short distance of local sights and/or your railway stations.

## HOW MUCH LUGGAGE CAN I BRING?

In general, each passenger can take two items of luggage plus one personal item. There are no weight restrictions - just remember you'll need to carry everything!

## CAN I ADD ON ADDITIONAL SIGHTSEEING OR ADDITIONAL HOTEL NIGHTS?

Yes, you can add additional sightseeing activities and/or hotel nights to most existing rail vacation packages we offer. When you speak with a Rail Expert, request an explanation of the upgrade options to your vacation package as you wish. Additional charges may apply.

## AM I ABLE TO TRAVEL ON MY CHOICE OF DATES?

There are no set departure dates with our vacations, with the exception of private train journeys such as the Venice Simplon-Orient-Express. Most trains will run every day, which means our vacations do too!

## CAN I CHOOSE MY TRAIN TIMES?

Our packages don't have set departure times, and if there is a train running when there are multiple trains a day, your Rail Expert will be able to talk you through the different departures. If there's a particularly convenient time or a departure that will ensure you catch the best scenery, we'll be sure to recommend it.

## HOW LONG BEFORE THE TRAIN DEPARTS SHOULD I BE AT THE STATION?

With the exception of Eurostar, which has a 45-minute check-in time, there is no official check-in required for train journeys in Europe or North America. Of course, we always recommend arriving at the station in plenty of time.

## WHEN WILL I RECEIVE MY TRAVEL DOCUMENTS?

After we receive full payment, travel documents will be sent to you approximately 21 days prior to your departure.

# CANADA

Embark on a captivating train journey through Canada, experiencing iconic landmarks like Niagara Falls, the Canadian Rockies, Toronto, Vancouver, Banff National Park, Quebec City, and stunning coastal vistas. Discover the grandeur of Canada's beauty on this unforgettable adventure.



# ULTIMATE CANADA AND ROCKIES WESTBOUND

Toronto → Niagara Falls → Jasper → Banff → Jasper → Vancouver

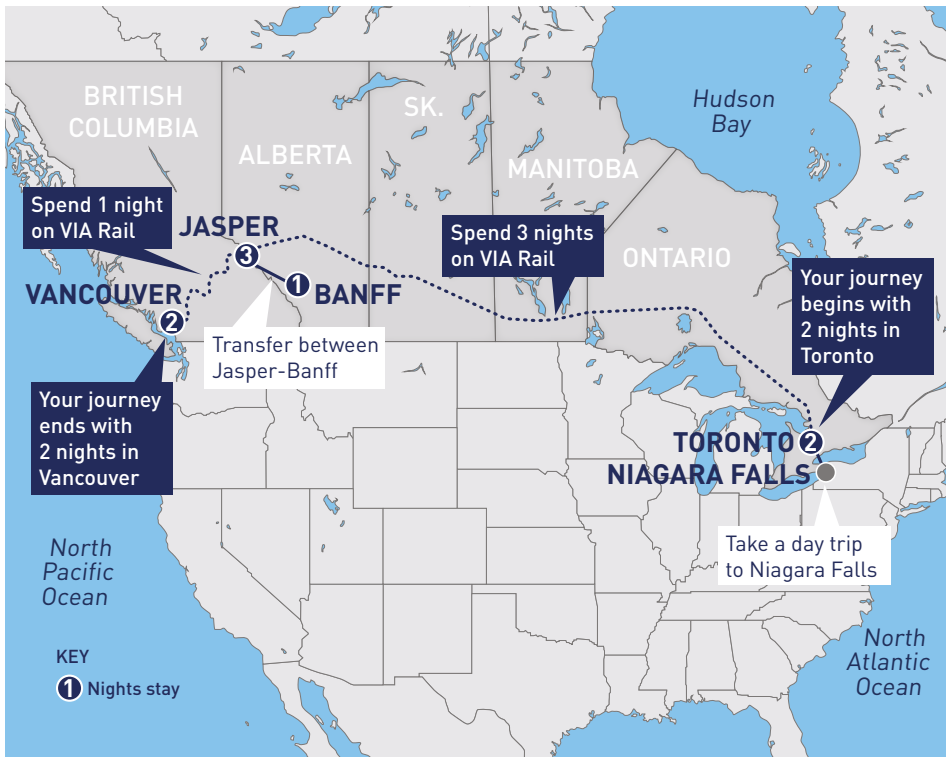
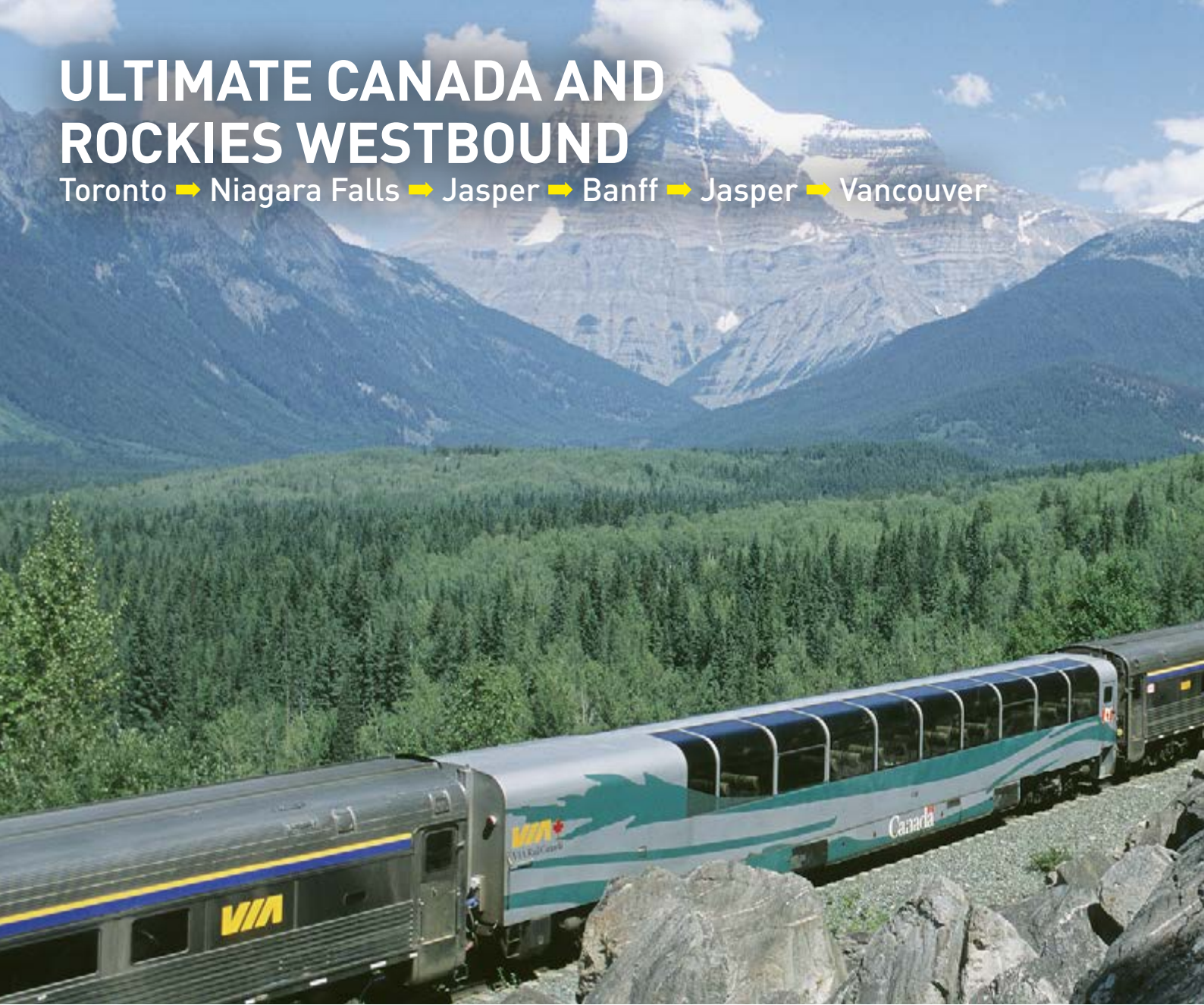



VIA Rail

## 13 DAYS

### CLICK HERE FOR MORE INFORMATION ON THIS TRIP

#### VACATION INCLUDES:

- 8 nights hotel accommodations; 4 nights onboard VIA Rail® One-way VIA Rail in economy accommodations from Toronto to Jasper; Jasper to Vancouver on The Canadian®
- Roundtrip shared transfers between Jasper and Banff
- Sightseeing tour of Niagara Falls and Niagara-on-the-Lake, Jasper National Park and the Icefields Parkway
- Admission to the Jasper Skytram
- Multi-day hop-on, hop-off sightseeing tour of Vancouver
- Admission to the Vancouver Lookout and the Capilano Suspension Bridge Park

#### FEATURED ACCOMMODATION

**Toronto** - Chelsea Hotel

**Jasper** - Chateau Jasper

**Banff** - Elk and Avenue Hotel

**Vancouver** - Hampton Inn & Suites by Hilton, Downtown Vancouver

Hotels are subject to availability.

Alternatives may be used.



Jasper

#### DAY 1 - TORONTO

Welcome to Toronto! Travel to your hotel and start exploring the city with your hop-on, hop-off sightseeing tour. Enjoy Toronto from the CN Tower. You'll be treated to beautifully sweeping views from 553 meters above the ground.

#### DAY 2 - TORONTO TO NIAGARA FALLS

This morning, you will be picked up at your hotel for a fun-filled day at one of the wonders of the natural world, Niagara Falls. Highlights of your day will include a meal overlooking the Falls, a ride on the lake, and a winery tour and tasting.

#### DAY 3 - OVERNIGHT ONBOARD VIA RAIL

Today, travel to the train station and board your overnight VIA Rail train west to the Canadian Rockies. (Overnight onboard VIA Rail)

#### DAYS 4 & 5 - OVERNIGHT ONBOARD VIA RAIL

Today, you'll enjoy a relaxing day on the train as you continue your journey on VIA Rail westbound to Jasper. Enjoy the breathtaking landscape along the way. For even more amazing views, head over to the observation car! The legendary scenery on this train route has made it one of the most renowned long-distance journeys in the world! (Overnight onboard VIA Rail)

#### DAY 6 - JASPER

Welcome to Jasper! The day is yours to start exploring!

#### DAY 7 - JASPER

Explore the spectacular natural treasures of Jasper National Park, the largest national park in the Canadian Rockies. Stand above the massive walls of Maligne Canyon for stunning views of rushing waterfalls. Discover the mystery of the disappearing water at Medicine Lake. Stroll the shores of Maligne Lake and breathe in the clean mountain air.

#### DAY 8 - JASPER TO BANFF

This morning, you will depart Jasper for a scenic drive out to Banff along the world-famous Icefields Parkway. Enjoy the wildlife, pristine lakes, and breathtaking mountain peaks. Upon your arrival in Banff, you'll get a chance to visit the natural wonder of the Columbia Icefield, one of the largest expanses of ice and snow south of the Arctic Circle.

#### DAY 9 - BANFF TO JASPER

Spend your free time this morning exploring Banff before your included afternoon shuttle back to Jasper. Upon your arrival in Jasper, check into your hotel and spend the night relaxing.

#### DAY 10 - OVERNIGHT ONBOARD VIA RAIL

This morning, you'll travel to the Via Rail station and board the train for your journey west to Vancouver. Enjoy the scenery of the Rockies while you relax on the train. Be sure to take a picture of Mount Robson, the tallest peak in the Canadian Rockies!

#### DAY 11 - VANCOUVER

This morning, you'll arrive in Vancouver and start your day with a hop-on, hop-off tour that takes you to Vancouver's most popular landmarks, including Stanley Park, Chinatown, Gastown, Granville Island, and many more great destinations! The tour will feature live commentary, so you'll have the opportunity to learn what makes the spectacular city of Vancouver so special. (Overnight in Vancouver)

#### DAY 12 - VANCOUVER

Continue exploring Vancouver today with your included admission to the Vancouver Lookout, which towers hundreds of feet above the city. Take some time to visit the Capilano Suspension Bridge Park, one of the most popular tourist attractions in British Columbia. The bridge crosses over towering evergreens with views more than 30 meters above the forest floor.

#### DAY 13 - YOUR JOURNEY ENDS IN VANCOUVER

# CLASSIC CANADA AND ROCKIES EASTBOUND

Vancouver → Jasper → Toronto

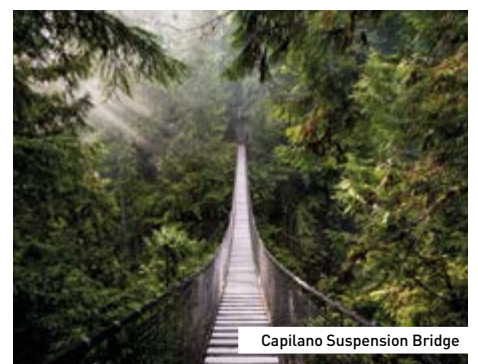
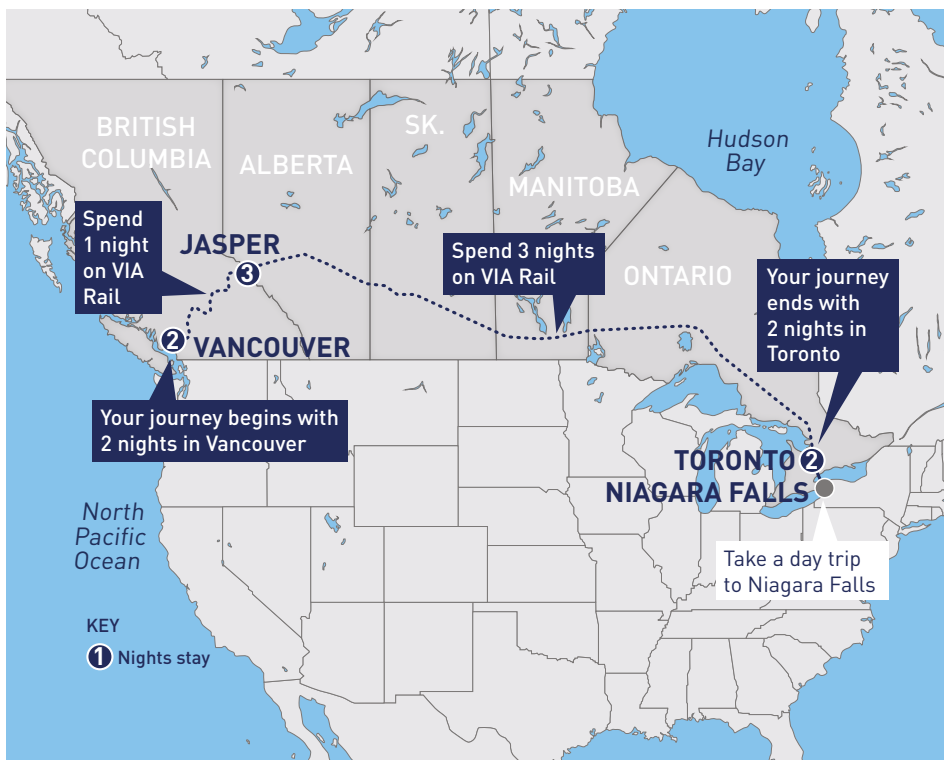

**12 DAYS****CLICK HERE FOR MORE  
INFORMATION ON THIS TRIP****VACATION INCLUDES:**

- 7 nights' hotel stay
- 4 nights onboard VIA Rail®
- One-way VIA Rail® in Economy class
- 2 meals (2 lunches)
- Hop-on, hop-off sightseeing tour of Vancouver
- Admission to the Vancouver Lookout
- Admission to the Capilano Suspension Bridge Park
- Admission to the Jasper Skytram
- Sightseeing tour of the Icefields Parkway
- Multi-day hop-on, hop-off sightseeing tour of Toronto
- Admission to the CN Tower
- Sightseeing tour of Niagara Falls and Niagara-on-the-Lake

**FEATURED ACCOMMODATION**

**Vancouver** - Hampton Inn & Suites by Hilton, Downtown Vancouver

**Jasper** - Chateau Jasper

**Toronto** - Chelsea Hotel

Hotels are subject to availability.  
Alternatives may be used.

**DAY 1 - ARRIVE IN VANCOUVER**

Welcome to Vancouver! Travel to your hotel and start exploring this vibrant city.

**DAY 2 - VANCOUVER**

Today's full day of sightseeing will start with a hop-on, hop-off sightseeing tour that takes you to Vancouver's most popular areas: Stanley Park, Chinatown, Gastown, Granville Island and more! Take some time this afternoon to visit the Capilano Suspension Bridge Park, one of the most popular tourist attractions in British Columbia. The bridge crosses over towering evergreens with views more than 30 meters above the forest floor. Also enjoy admission to the Vancouver Lookout today for amazing, panoramic views of the entire city.

**DAY 3 - OVERNIGHT ONBOARD VIA RAIL**

Continue to explore Vancouver on your own this morning before an afternoon departure to Jasper and the majestic Canadian Rockies. While onboard, enjoy a sparkling wine send-off in one of the train's many domed observation cars and dinner while passing gorgeous scenery.

**DAY 4 - JASPER**

Open your bedroom blinds this morning to find the towering Rocky Mountains outside your window. Take in Mt. Robson, the tallest peak in the Canadian Rockies and Moose Lake, one of its deepest, before a morning arrival into Jasper.

**DAY 5 - JASPER**

Explore the spectacular natural treasures of Jasper National Park today. During this immersive tour, stand above the massive walls of Maligne Canyon for stunning views of rushing waterfalls, discover the mystery of the disappearing water at Medicine Lake and stroll the shores of crystal-clear Maligne Lake. Later today, board the Jasper Skytram and lift off for the flight of a lifetime! During your seven-minute flight, you will be accompanied by a fully trained and knowledgeable flight attendant who will point out the many sights and answer any questions you may have. As the tram gently touches down, step out onto the Upper Station and prepare for a whole new perspective on the Canadian Rockies.

**DAY 6 - JASPER**

Today's exciting excursion follows the famous Icefields Parkway to the Columbia Icefield Glacier Discovery Centre. View scenic rocky mountain vistas and local wildlife along the way, with photo stops at Athabasca Falls and Stutfield Glacier. At the Glacier Skywalk, step onto a glass-floored observation platform extending 280 meters out over the Sunwapta Valley. Wrap up your journey with a hot buffet lunch and time to explore the Columbia Icefield Glacier Discovery Center.

**DAY 7 - OVERNIGHT ONBOARD VIA RAIL**

Board The Canadian this afternoon for an exhilarating and relaxing ride across Canada.

**DAY 8 & 9 OVERNIGHT ONBOARD VIA RAIL**

Continue your scenic journey across Canada on VIA Rail. Enjoy the relaxed pace on the train, and get in tune with the natural beauty that surrounds you.

**DAY 10 - TORONTO**

Begin your sightseeing of Toronto today with a hop-on, hop-off bus tour featuring top Toronto sights such as the Royal Ontario Museum, Casa Loma, the Hockey Hall of Fame, Toronto Harbourfront, Eaton Centre and Chinatown, among others. Admission to the CN Tower, with sweeping views of Toronto, is also included.

**DAY 11 - NIAGARA FALLS**

This morning, you will be picked up at your hotel for a full day tour to one of the wonders of the natural world, Niagara Falls. Highlights will include a meal overlooking the falls, a boat ride getting you up close and personal with the Falls, and a winery tour and tasting. After your full day of touring, your bus will drop you back off at your hotel for a relaxing evening.

**DAY 12 - YOUR JOURNEY ENDS  
IN TORONTO**

Toronto

# CANADIAN ROCKIES DISCOVERY EASTBOUND

Vancouver → Victoria → Jasper → Banff → Lake Louise → Calgary

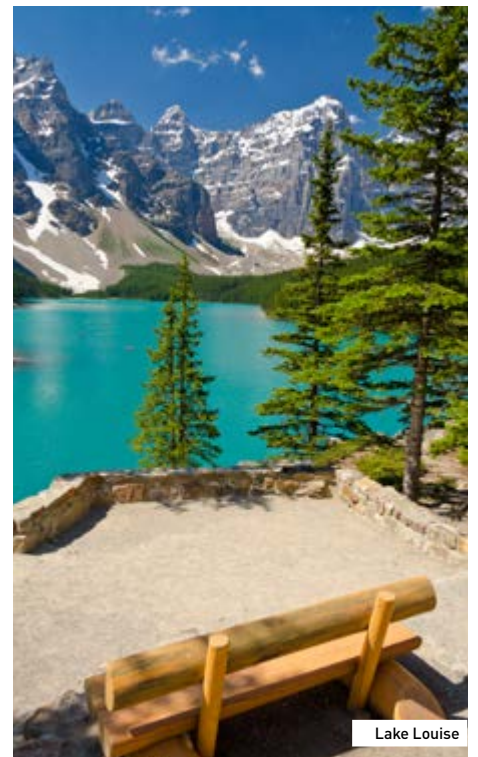

Lake Louise

## 10 DAYS

### CLICK HERE FOR MORE INFORMATION ON THIS TRIP

#### VACATION INCLUDES:

- 8 nights' hotel stay
- 1 night onboard VIA Rail®
- One-way VIA Rail® in Economy class
- Roundtrip ferry service from Vancouver to Victoria
- Transfer from Jasper to Banff and Banff to Calgary
- 2 meals (2 lunches)
- Hop-on, hop-off sightseeing tour of Vancouver
- Admission to the Vancouver Lookout
- Sightseeing tours of the Canadian Rockies, Jasper National Park, the Icefields Parkway and Lake Louise

#### FEATURED ACCOMMODATION

**Vancouver** - Hampton Inn & Suites by Hilton, Downtown Vancouver

**Jasper** - Chateau Jasper

**Banff** - Buffalo Mountain Lodge

**Calgary** - Holiday Inn Express

Hotels are subject to availability.

Alternatives may be used.



Onboard VIA

#### DAY 1 - ARRIVE IN VANCOUVER

Welcome to Vancouver! Travel to your hotel and start exploring this nature lover's paradise, where the majestic mountains meet the serene coast.

#### DAY 2 - VANCOUVER

Today's full day of sightseeing begins with a hop-on, hop-off sightseeing tour that will take you to all of Vancouver's most popular attractions, including Stanley Park, Chinatown, Gastown, Granville Island, and more!

#### DAY 3 - VICTORIA

Travel on board the ferry to Victoria. Set on the sparkling Strait of Juan de Fuca, at the southern tip of Vancouver Island, this quaint coastal gem has a dynamic blend of serene mountain views, historic charm, and urban appeal.

#### DAY 4 - OVERNIGHT ONBOARD VIA RAIL

Discover more of Vancouver at your leisure this morning before making your way to the VIA Rail station for an afternoon departure on The Canadian eastbound to Jasper.

#### DAY 5 - JASPER

Wake up to sunrise in the Canadian Rockies on the train! Take in the majestic landscape as you wind through the breathtaking mountain scenery before your morning arrival into Jasper.

#### DAY 6 - JASPER NATIONAL PARK

Explore the spectacular natural treasures of the largest national park in the Canadian Rockies. During this exhilarating sightseeing tour, you will see many picture-perfect sights, including Athabasca Viewpoint, Maligne Canyon, Medicine Lake, and Maligne Lake.

#### DAY 7 - JASPER TO BANFF

Depart Jasper for a leisurely drive out to Banff, one of the most scenic towns in the Canadian Rockies. Enjoy the wildlife, pristine lakes, and breathtaking mountain peaks along the world-famous Icefields Parkway. Step onboard the Ice Explorer for an interpretive adventure of the Athabasca Glacier. Enjoy unobstructed views on a glass-floored observation platform extending out over the Sunwapta Valley at the Glacier Skywalk. Lunch is included today.

#### DAY 8 - BANFF TO LAKE LOUISE

Explore Lake Louise, one of the most photographed landscapes in the Canadian Rockies. You will also tour Johnston Canyon, another spectacular treasure of the Rockies.

#### DAY 9 - BANFF TO CALGARY

Today you will take your included shuttle transfer from Banff to your hotel in Calgary, the largest city in Alberta. The rest of the evening is yours to enjoy this amazing city!

#### DAY 10 - YOUR JOURNEY ENDS IN CALGARY



Victoria

# GRAND CIRCLE OF THE CANADIAN ROCKIES

Vancouver → Kamloops → Banff → Lake Louise → Jasper → Vancouver

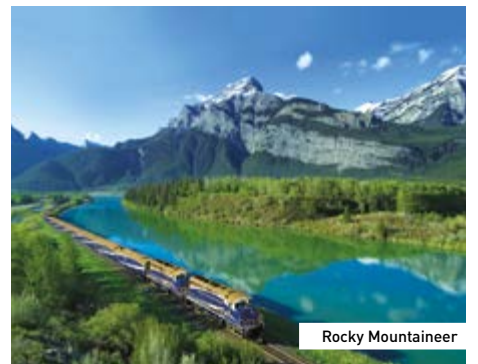

**10 DAYS****CLICK HERE FOR MORE  
INFORMATION ON THIS TRIP****VACATION INCLUDES:**

- 8 nights' hotel stay
- 1 night onboard VIA Rail®
- Rocky Mountaineer from Vancouver to Banff in SilverLeaf class
- One-way VIA Rail® in Economy class
- Transfer from Banff to Lake Louise
- Transfer from Lake Louise to Jasper
- 5 meals (2 breakfasts, 3 lunches)
- Sightseeing tour of Banff National Park and Lake Louise
- Admission to the Banff Gondola
- Sightseeing tour of the Icefields Parkway
- Sightseeing tour of Jasper National Park

**FEATURED ACCOMMODATION**

**Vancouver** - Hampton Inn & Suites by Hilton, Downtown Vancouver

**Kamloops** - Three-star accommodation will be selected

**Banff** - Buffalo Mountain Lodge

**Lake Louise** - Fairmont Chateau Lake Louise

**Jasper** - Chateau Jasper

Hotels are subject to availability.

Alternatives may be used.



VIA Rail

**DAY 1 - ARRIVE IN VANCOUVER**

Welcome to Vancouver! Spend the day exploring this nature lover's paradise with its serene coast and a majestic mountain backdrop.

**DAY 2 - ROCKY MOUNTAINEER FROM VANCOUVER TO KAMLOOPS**

This morning, board the famous Rocky Mountaineer. Settle into the luxurious accommodations and relax onboard, soaking in the spectacular scenery. Travel through British Columbia with views of the Cascade Mountains and along the spectacular Fraser Canyon and River.

**DAY 3 - ROCKY MOUNTAINEER FROM KAMLOOPS TO BANFF**

Enjoy another day of striking scenery today as you make your way to Banff, Alberta. Travel through the heart of the Canadian Rockies and wind through the snow-capped peaks.

**DAY 4 - BANFF**

Explore the mountain town of Banff today and journey to the top of Sulphur Mountain on the incredible Banff Gondola. From the summit, you'll have a birds-eye view of Banff National Park and the Canadian Rockies!

**DAY 5 - BANFF TO LAKE LOUISE**

Depart on a scenic tour through Banff and Yoho National Parks full of emerald lakes and breathtaking waterfalls. End your tour in Lake Louise, one of the most photographed landscapes in the Canadian Rockies, where you will spend the evening.

**DAY 6 - LAKE LOUISE TO JASPER**

Travel along the world-famous Icefields Parkway as you head to Jasper. You'll make a stop along the way to visit the natural wonder of Columbia Icefield, one of the largest expanses of ice and snow south of the Arctic Circle. There, you'll board the Ice Explorer and venture out to Athabasca Glacier where you'll have one of the best vantage points to view the entire area.

**DAY 7 - JASPER NATIONAL PARK**

Explore the largest national park in the Canadian Rockies today, Jasper National Park. On today's tour, you will see many breathtaking sights, including Athabasca Viewpoint, Maligne and Medicine Lake. Stand above the massive walls of Maligne Canyon for stunning views of rushing waterfalls.

**DAY 8 - OVERNIGHT ONBOARD VIA RAIL**

This morning, board VIA Rail's legendary transcontinental train, The Canadian, and settle in to a nostalgic overnight rail journey to Vancouver

complete with delicious food options, comfortable accommodations and access to domed observation cars.

**DAY 9 - VANCOUVER**

Upon arrival in Vancouver, check in at your hotel for an overnight stay and begin discovering the many attractions of the city.

**DAY 10 - YOUR JOURNEY ENDS IN VANCOUVER**

Banff

# CANADIAN ROCKIES AND COAST JOURNEY

Vancouver → Jasper → Prince George → Prince Rupert



**9 DAYS****CLICK HERE FOR MORE  
INFORMATION ON THIS TRIP****VACATION INCLUDES:**

- 7 nights' hotel stay
- 1 night onboard VIA Rail®
- One-way VIA Rail® in Economy class
- 1 meal (1 lunch)
- Hop-on, hop-off sightseeing tour of Vancouver
- Admission to the Vancouver Lookout
- Sightseeing tour of the Canadian Rockies and Jasper National Park
- Grizzly Bear Tour OR Whale Watching Tour in Prince Rupert\*

\*Grizzly Bear Tour runs mid-May - end of July; Whale Watching Tour runs end of July - end of September.

**FEATURED ACCOMMODATION**

**Vancouver** - Hampton Inn & Suites by Hilton, Downtown Vancouver

**Jasper** - Chateau Jasper

**Prince George** - Ramada Plaza

**Prince Rupert** - Inn on the Harbour

Hotels are subject to availability. Alternatives may be used.

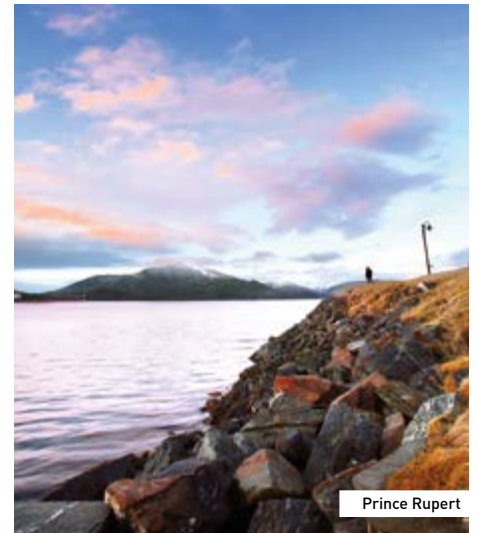

Prince Rupert

**DAY 1 - ARRIVE IN VANCOUVER**

Welcome to Canada! After you drop your bags at your hotel, begin exploring the exciting coastal city of Vancouver.

**DAY 2 - VANCOUVER**

Today your hop-on, hop-off tour will take you to all of Vancouver's most popular attractions and allow you to stop and get off at any site you want to explore more. With live commentary on board, you'll learn interesting facts about the city and the history of places like Gastown, Granville Island, and more! Also use your admission to the Vancouver Lookout for incredible views of the entire city.

**DAY 3 - OVERNIGHT ONBOARD VIA RAIL**

Continue to explore Vancouver on your own this morning before an afternoon departure on VIA Rail's Canadian to Jasper and the majestic Canadian Rockies. While onboard, enjoy a sparkling wine send-off in one of the train's many domed observation cars and dinner while passing through Vancouver's eastern suburbs and into British Columbia's agricultural heartland.

**DAY 4 - JASPER**

Wake up on the train this morning to find the towering Rocky Mountains outside your window. Take in Mt. Robson, the tallest peak in the Canadian Rockies and Moose Lake, one of its deepest, before a morning arrival into Jasper.

**DAY 5 - JASPER NATIONAL PARK**

Explore Jasper National Park on a guided tour which will take you to scenic waterfalls, deep canyons and crystal-clear lakes. Highlights of the tour include Athabasca Viewpoint, Maligne Canyon, Medicine Lake, Maligne Lake and more!

**DAY 6 - JASPER TO PRINCE GEORGE**

This afternoon, depart Jasper for one of the most scenic train rides in all of British Columbia, through the natural wonders of Jasper National Park and the Canadian Rockies as you make your way to Prince George. Arrive in the evening and transfer on your own to the hotel.

**DAY 7 - PRINCE GEORGE TO PRINCE RUPERT**

This morning, re-board the train and continue this stunning journey along to Prince Rupert, taking in more of the wondrous landscapes of the Coast Mountains, from the sparkling lakes and beautiful rivers to the snow-capped mountain peaks. Enjoy a relaxing, comfortable and truly scenic all-daylight ride into picturesque Prince Rupert.

**DAY 8 - PRINCE RUPERT**

Today enjoy a tour out to the pristine wilderness of the Kluane region, home of the largest population of grizzly bears anywhere on Earth. Or enjoy a whale watching tour around the North Coast's sheltered Inside Passage where you may encounter gray whales, orca following the salmon migration, porpoises, sea lions and more!

**DAY 9 - YOUR JOURNEY ENDS  
IN PRINCE RUPERT**

Jasper National Park

# CANADIAN ROCKIES ADVENTURE

Vancouver → Jasper → Vancouver

Icefields Parkway



**7 DAYS**

**CLICK HERE FOR MORE INFORMATION ON THIS TRIP**

#### VACATION INCLUDES:

- Roundtrip VIA Rail in Economy accommodations onboard the Canadian®
- 4 nights hotel accommodations in Jasper
- 2 nights on VIA Rail®\*
- Sightseeing tour of the Icefields Parkway with the Glacier Skywalk
- Sightseeing tour to Maligne Lake with a boat cruise
- 1 meal included (1 lunch)

#### FEATURED ACCOMMODATION

**Jasper** - Chateau Jasper  
Hotels are subject to availability.  
Alternatives may be used.



Maligne Lake

## DAY 1 - OVERNIGHT ONBOARD VIA RAIL

Your journey begins when you board the train in Vancouver! Today you will board VIA Rail's The Canadian® and begin your journey through the mountain region as you travel to Jasper! (Overnight onboard VIA Rail)

## DAY 2 - JASPER

Wake up this morning to views of the scenic snowcapped mountains! Relax and spend time in the domed observation car where the panoramic views of wildlife and the breathtaking landscape are unparalleled. Tonight, you will transfer on your own and check into your hotel. Afterwards you may want to take a stroll through downtown Jasper and dine at one of the amazing restaurants or cafes!

## DAY 3 - JASPER

This morning, you will depart on a sightseeing tour where you will enjoy the wildlife, pristine lakes, and majestic mountain peaks along the world-famous Icefields Parkway. Visit the natural wonder that is Columbia Icefield, one of the

largest expanses of ice and snow south of the Arctic Circle. Step onboard an Ice Explorer for an interpretive adventure of the Athabasca Glacier. At the Glacier Skywalk, enjoy the unobstructed view on a glass-floored observation platform extending 30m out over the Sunwapta Valley. After a full day of sightseeing, get to know Jasper, one of the most scenic towns in the Canadian Rockies.

## DAY 4 - JASPER

Today you will tour the magnificent Maligne Valley. Your tour guide will take you through the Maligne Canyon where you will walk above the gorge. Then you will continue on to Medicine Lake and Maligne Lake where you will board your boat cruise to Spirit Island. Cruising this serene mountain lake is a truly unforgettable experience.

## DAY 5 - JASPER

Ascend to the lofty peak known as "The Whistlers" on the Jasper Skytram. This aerial tramway ascends to the mountaintop in less than eight minutes. Take in the breathtaking views of the Canadian Rockies and the valleys below.

## DAY 6 - OVERNIGHT ONBOARD VIA RAIL

This afternoon you will board VIA Rail and take journey back towards Vancouver onboard The Canadian line. As the sun sets over the mountains, take a moment to reflect on all the natural beauty of the Canadian Rockies. (Overnight onboard VIA Rail)

## DAY 7 - YOUR JOURNEY ENDS IN VANCOUVER



Glacier Skywalk

# WESTERN CANADA AND THE CANADIAN ROCKIES

Edmonton → Jasper → Banff → Calgary



**6 DAYS**

**CLICK HERE FOR MORE INFORMATION ON THIS TRIP**

**VACATION INCLUDES:**

- One-way VIA Rail® in Economy from Edmonton to Jasper on The Canadian®
- 5 nights hotel accommodations
- Sightseeing city tour of Jasper
- Maligne Lake Cruise\*
- Sightseeing tour of the Icefields Parkway from Jasper to Banff
- Sightseeing tour of Banff including admission to the Banff Gondol.

**FEATURED ACCOMMODATION**

**Edmonton** - Coast Edmonton Plaza Hotel  
**Jasper** - Chateau Jasper  
**Banff** - Buffalo Mountain  
 Hotels are subject to availability. Alternatives may be used.



## DAY 1 - OUR JOURNEY BEGINS IN EDMONTON

Start your journey in the beautiful capital of Alberta. Enjoy your free time in Edmonton to explore the many parks and museums the city has to offer.



## DAY 2 - EDMONTON TO JASPER

This morning, travel on your own to the train station for the quick journey to Jasper. Upon arrival, drop off your bags at your hotel and take advantage of your free afternoon discovering the Alpine town of Jasper.

## DAY 3 - JASPER

Today, explore Jasper National Park and indulge in its natural mountainous beauty, soak in the attractions of the Maligne Canyon, and solve the mystery of the disappearing lake during your tour of Jasper and on your cruise across the crystal-clear blue waters of Maligne Lake.

## DAY 4 - JASPER TO BANFF

Today, enjoy a sightseeing adventure along the Icefields Parkway through the Canadian Rockies as you head to Banff. Voyage through the remnants of the last Ice Age and observe the monuments of rock and ice that still remain today. Enjoy once in a lifetime experience traveling onto the surface of the ancient Athabasca Glacier on a

specialty-designed, giant all-terrain Ice Explorer. Stand suspended on the Glacier Skywalk's glass-floored platform 280 meters over the spectacular glacier-formed valleys. An unforgettable experience awaits you today!

## DAY 5 - BANFF

Enjoy some of the best sights of the Canadian Rockies on your Banff guided tour today. Learn about culture, geology and wildlife while exploring the spectacular sights of the renowned mountain town of Banff. Then soar up the Banff Gondola to the peak of Sulphur Mountain for a 360-degree view of six mountain ranges and the Bow Valley.

## DAY 6 - YOUR JOURNEY ENDS IN CALGARY

Transfer to Calgary airport for your return trip home.

# TRANS CANADA AND ROCKIES ADVENTURE WITH ROCKY MOUNTAINEER

Toronto → Niagara Falls → Jasper → Lake Louise → Banff  
→ Kamloops → Vancouver

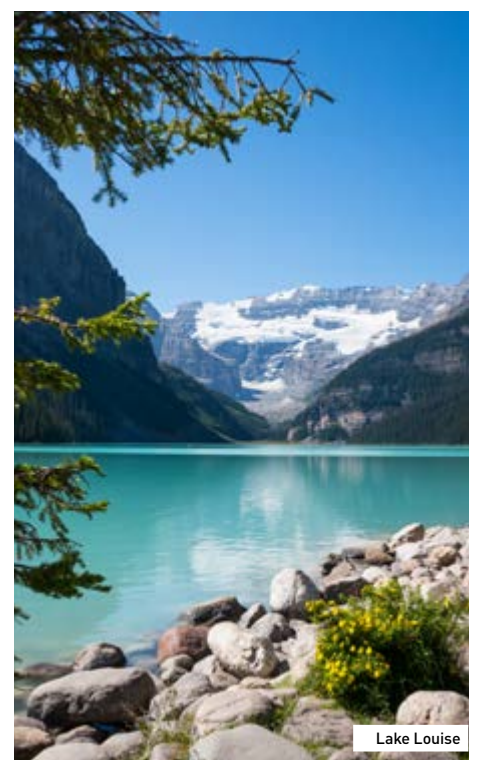
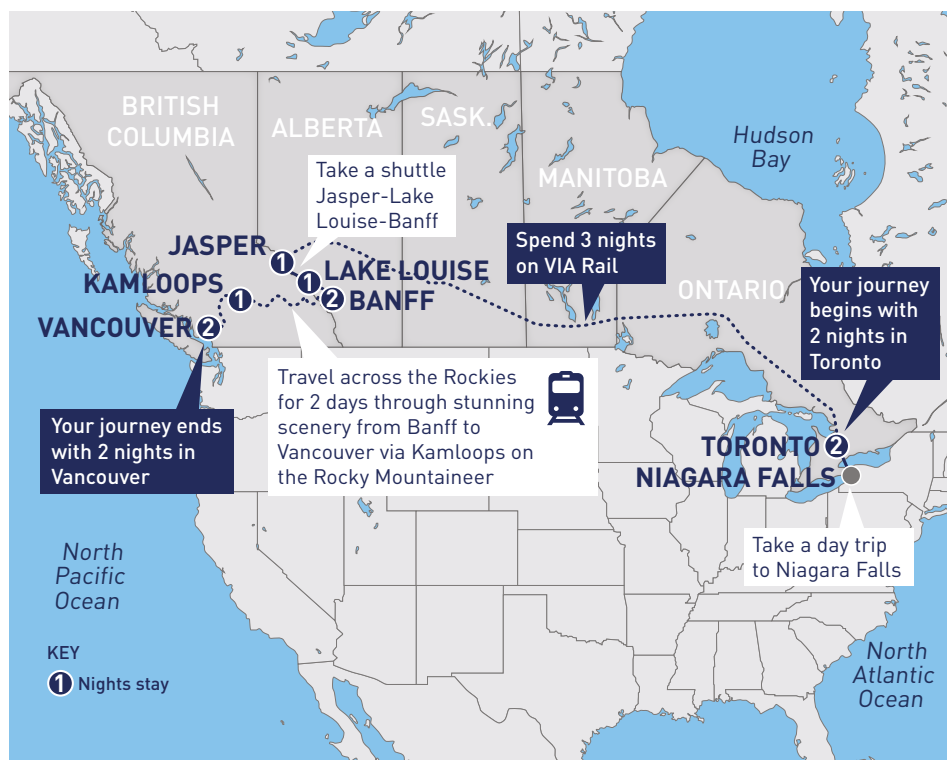

**13 DAYS****CLICK HERE FOR MORE  
INFORMATION ON THIS TRIP****VACATION INCLUDES:**

- 10 nights' hotel stay
- 3 nights onboard VIA Rail
- Rocky Mountaineer from Banff to Vancouver in SilverLeaf Class
- One-way VIA Rail in Economy class
- Transfer from Jasper to Lake Louise and Lake Louise to Banff
- Hop-on, hop-off tour of Toronto
- Sightseeing tour of Niagara Falls and Niagara-on-the-Lake
- Admission to the Jasper Skytram
- Sightseeing tour of the Icefields Parkway and the Canadian Rockies
- Sightseeing tour of Banff National Park
- Admission to the Banff Gondola
- Hop-on, hop-off sightseeing tour of Vancouver

**FEATURED ACCOMMODATION****Toronto** - Chelsea Hotel**Jasper** - Chateau Jasper**Lake Louise** - Fairmont Lake Louise**Banff** - Buffalo Mountain Lodge**Kamloops** - Three star accommodation will be selected**Vancouver** - Hampton Inn & Suites by Hilton, Downtown Vancouver**Hotels are subject to availability.  
Alternatives may be used.**

Niagara Falls

**DAY 1 - ARRIVE IN TORONTO**

Begin your adventure in Toronto. Check in at your hotel and enjoy a night to discover the city at your leisure.

**DAY 2 - NIAGARA FALLS**

This morning, you will be picked up at your hotel for a full day tour to one of the wonders of the natural world, Niagara Falls. Highlights include a meal overlooking the falls, a ride on a sightseeing cruise, free time in both Niagara Falls and Niagara-on-the-Lake, and a winery tour and tasting.

**DAY 3 - OVERNIGHT ONBOARD VIA RAIL**

This morning, make your way to the station and board VIA Rail's The Canadian. Settle in for a scenic and comfortable journey across Canada to Jasper.

**DAY 4 & 5 - OVERNIGHT ONBOARD VIA RAIL**

Spend two days on board the train! With fantastic food, gorgeous views and good company, it's the perfect way to travel.

**DAY 6 - JASPER**

After enjoying the last leg of your rail journey through the heart of the mountains, arrive in Jasper today. Spend the afternoon enjoying the fresh mountain air and tranquil scenery of this classic alpine town, deep in the heart of the Canadian Rockies.

**DAY 7 - JASPER TO LAKE LOUISE**

Enjoy both of Canada's oldest and largest national parks on the way to Lake Louise today! Connected by the Icefields Parkway, Jasper and Banff National Parks are home to alpine glaciers, turquoise lakes and a variety of mountain wildlife. At the Columbia Icefield, take an all-terrain Ice Explorer onto the mighty Athabasca Glacier for a once in a lifetime experience. Next, it's on to Lake Louise, check in at the world-famous Fairmont Chateau Lake Louise for an overnight stay.

**DAY 8 - LAKE LOUISE TO BANFF**

Pick up your transfer and make your way from Lake Louise to beautiful Banff. Begin exploring the immense natural beauty, boutique shops and traditional restaurants of this Rocky Mountain town.

**DAY 9 - BANFF**

Unearth the geological and cultural secrets of Banff with an included tour today. Admire some of the most amazing scenery in the the Canadian Rockies. Travel up the Banff Gondola to the summit of Sulphur Mountain to enjoy 360-degree panoramas of no less than six mountain ranges.

**DAY 10 - ROCKY MOUNTAINEER FROM BANFF TO KAMLOOPS**

Board the iconic blue and gold carriages of the Rocky Mountaineer for a scenic journey through Canada's breathtaking mountainous vistas. Settle

into your SilverLeaf accommodations, or speak to one of our Rail Experts about upgrading to GoldLeaf, and gaze out of the panoramic windows as you go. The journey from Banff to Kamloops will take you past snow-capped peaks and glaciers as you traverse mountain passes. Arrive in Kamloops in the evening and transfer to your hotel for an overnight stay.

**DAY 11 - ROCKY MOUNTAINEER FROM KAMLOOPS TO VANCOUVER**

Depart Kamloops for Vancouver today, re-boarding the Rocky Mountaineer for another exquisite journey. Leave the interior and wind past rushing rivers, dramatic canyons and evergreen forests as you make your way to the Coast and the Cascade Mountains.

**DAY 12 - VANCOUVER**

Enjoy a full day at leisure in Vancouver! Use your included hop-on, hop-off tour to navigate the city with ease, creating your own personalized sightseeing itinerary.

**DAY 13 - YOUR JOURNEY ENDS IN VANCOUVER**

# CANADIAN ROCKIES WINTER DISCOVERY EASTBOUND

Vancouver ➔ Jasper ➔ Banff ➔ Calgary

VIA Rail in Winter

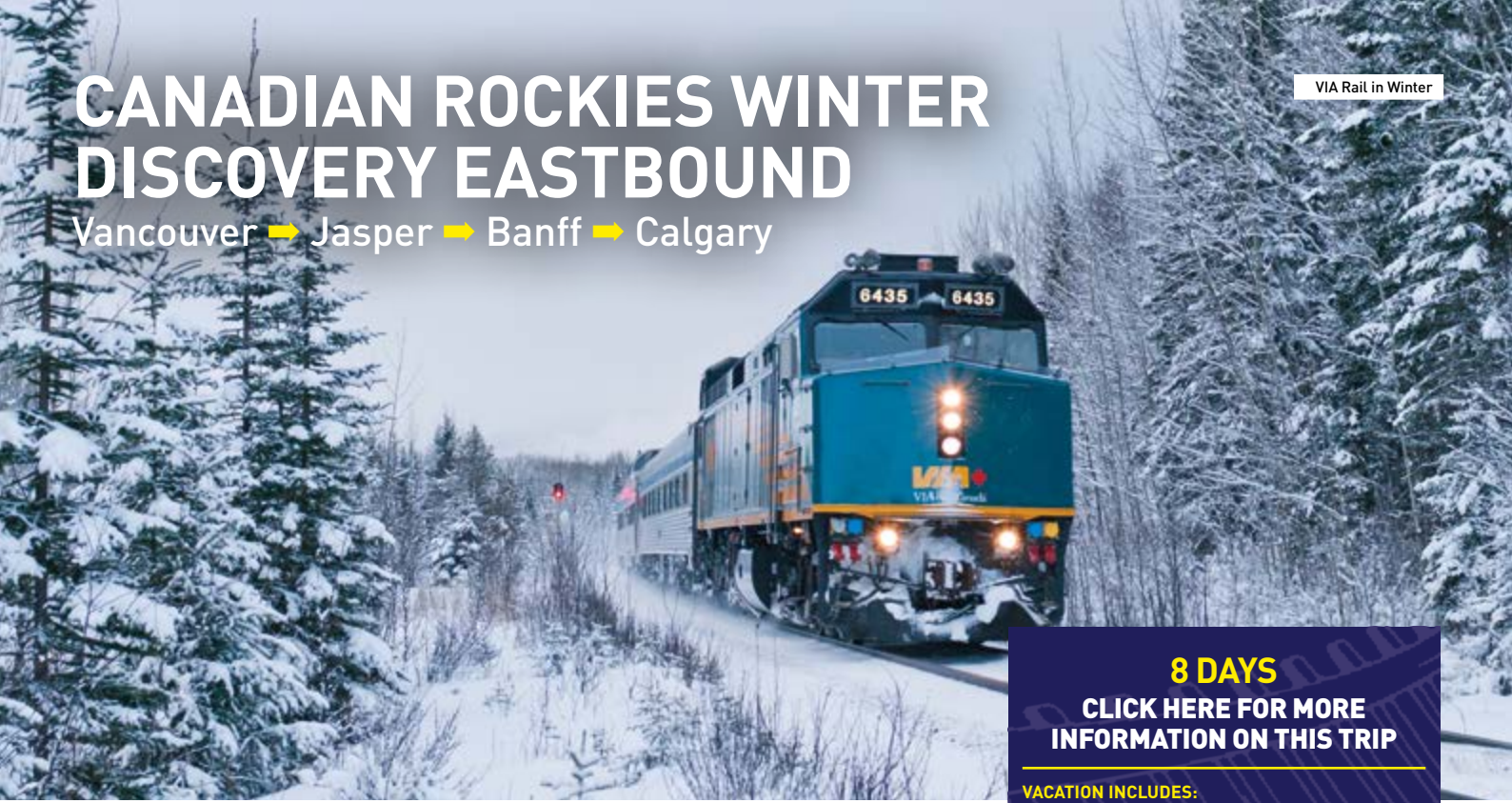

**8 DAYS**  
**CLICK HERE FOR MORE INFORMATION ON THIS TRIP**

#### VACATION INCLUDES:

- 6 nights' hotel stay
- 1 night onboard VIA Rail
- One-way VIA Rail® in Economy class
- Transfer from Jasper to Banff and Banff to Calgary
- Hop-on, hop-off sightseeing tour of Vancouver
- Admission to the Vancouver Lookout
- Winter wildlife tour in Jasper National Park
- Admission to the Banff Gondola

#### FEATURED ACCOMMODATION

**Vancouver** - Hampton Inn & Suites by Hilton, Downtown Vancouver  
**Jasper** - Chateau Jasper  
**Banff** - Buffalo Mountain Lodge  
Hotels are subject to availability. Alternatives may be used.

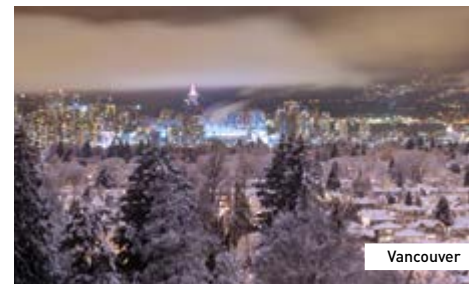

## DAY 1 - ARRIVE IN VANCOUVER

Welcome to Vancouver! Travel on your own to your hotel and then begin exploring this unique city where the serene coast meets the soaring mountains.



## DAY 2 - VANCOUVER

A full day of sightseeing awaits you today! With an included hop-on, hop-off sightseeing tour, you'll learn all about the city and its history with live commentary. Feel free to hop off the tour and explore any sites in-depth at your leisure including Stanley Park, Chinatown, Gastown, Granville Island, and more!

## DAY 3 - OVERNIGHT ONBOARD VIA RAIL

This afternoon, travel on your own to the VIA Rail station and board The Canadian eastbound to Jasper. Relax stress-free on this scenic journey with comfortable accommodations and delicious food options onboard.

## DAY 4 - JASPER

Wake up relaxed and refreshed on the train and relax in the observation car, taking in the beautiful landscapes and winter wonderland that passes you by as you travel through the Canadian Rockies and on to Jasper. Once you arrive and get settled in, spend some time discovering Jasper, including

the excellent shops and restaurants in charming downtown.

## DAY 5 - JASPER NATIONAL PARK

Explore the spectacular Jasper National Park, the largest national park in the Canadian Rockies, and search for winter wildlife on your guided tour today.

## DAY 6 - JASPER TO BANFF

This morning, depart Jasper for a scenic drive on the Icefields Parkway to Banff, one of the most beautiful towns in the Canadian Rockies.

## DAY 7 - BANFF

Today, you'll take a gondola to the top of Sulphur Mountain for one of the best views of the Canadian Rockies. From there, you can enjoy the snowy mountain vistas from six different mountain ranges, Bow Valley and more.

## DAY 8 - YOUR JOURNEY ENDS IN CALGARY

# CLASSIC CANADA AND CANADIAN ROCKIES IN WINTER

Toronto → Jasper → Vancouver



**10 DAYS**  
**CLICK HERE FOR MORE INFORMATION ON THIS TRIP**

**VACATION INCLUDES:**

- 5 nights' hotel stay
- 4 nights onboard VIA Rail®
- One-way VIA Rail® in Economy class
- Admission to the CN Tower in Toronto
- Winter wildlife tour in Jasper National Park
- Maligne Canyon Icewalk Tour in Jasper
- Admission to the Vancouver Lookout

**FEATURED ACCOMMODATION**

**Toronto** - Chelsea Hotel  
**Jasper** - Chateau Jasper  
**Vancouver** - Hampton Inn & Suites by Hilton, Downtown Vancouver  
 Hotels are subject to availability. Alternatives may be used.



**DAY 1 - ARRIVE IN TORONTO**  
 Welcome to Toronto, Canada's most populous city! Use your admission to the CN Tower.

**DAY 2 - OVERNIGHT ONBOARD VIA RAIL**  
 Board VIA Rail in the morning for your journey across Canada.



**DAYS 3 & 4 - OVERNIGHT ONBOARD VIA RAIL**

Settle in to one of the world's most famous rail journeys while taking in the stunning scenery of the Canadian Shield and endless prairie fields. Enjoy comfortable onboard accommodations, delicious, freshly prepared meals and fun onboard activities.

**DAY 5 - JASPER**  
 Wake up on the train and take in the gorgeous winter wonderland that surrounds you as you travel through the Canadian Rockies to Jasper.

**DAY 6 - JASPER NATIONAL PARK**  
 Take an immersive winter wildlife tour of Jasper National Park today. Your knowledgeable guide will reveal the park's most iconic wildlife - you may see elk, deer, sheep, coyotes, moose and more!

**DAY 7 - JASPER NATIONAL PARK**  
 Enjoy a truly unique experience today with your Maligne Canyon Icewalk Tour. You'll be taken to the bottom of Maligne Canyon, the deepest accessible canyon in Jasper National Park, where you will explore frozen waterfalls, ice caves, and incredible ice formations.

**DAY 8 - JASPER TO VANCOUVER**  
 Visit some of the local shops and cafes in Jasper today before departing for Vancouver this afternoon. Once on board, enjoy more spectacular views of the snowy Canadian Rockies as the train heads out of Jasper.

**DAY 9 - VANCOUVER**  
 Arrive in Vancouver early this morning for an overnight stay. Use your admission to the Vancouver Lookout.

**DAY 10 - YOUR JOURNEY ENDS IN VANCOUVER**

# CANADIAN RAIL EXPERIENCE – TORONTO TO VANCOUVER

Toronto → Vancouver



Vancouver

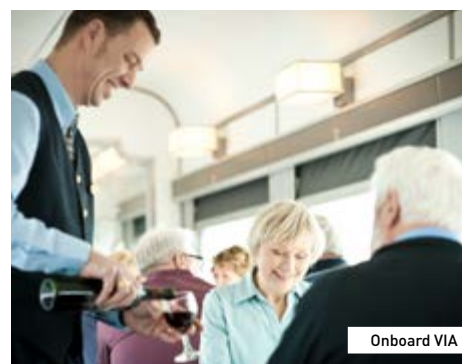

Onboard VIA

**8 DAYS****CLICK HERE FOR MORE  
INFORMATION ON THIS TRIP****VACATION INCLUDES:**

- 3 nights' hotel stay
- 4 nights onboard VIA Rail®
- One-way VIA Rail® in Economy class
- Hop-on, hop-off sightseeing tour of Toronto
- Hop-on, hop-off sightseeing tour of Vancouver
- Admission to the Vancouver Lookout

**FEATURED ACCOMMODATION****Toronto** - Chelsea Hotel**Vancouver** - Hampton Inn & Suites by Hilton,  
Downtown VancouverHotels are subject to availability.  
Alternatives may be used.

Toronto

**DAY 1 - ARRIVE IN TORONTO**

Welcome to Toronto! Use your hop-on, hop-off sightseeing tour to see the city's top attractions.

**DAY 2 - OVERNIGHT ONBOARD VIA RAIL**

Travel on your own to the VIA Rail station and board the iconic Canadian line for your exciting four-day trip across Canada.

**DAY 3 - OVERNIGHT ONBOARD VIA RAIL**

Enjoy this unforgettable journey through the heart of the Canadian countryside! Sit back and relax on this stress-free ride, enjoy delicious food and spacious, comfortable accommodations. Mix and mingle freely with fellow passengers, or simply gaze out the window at the natural wonders that surround you.

**DAY 4 - OVERNIGHT ONBOARD VIA RAIL**

Continue your sightseeing train experience today. Be sure to have your camera handy as the plains give way to foothills. The views are stunning and you'll want to capture so many of the amazing landscapes your cross-Canada trip takes in.

**DAY 5 - OVERNIGHT ONBOARD VIA RAIL**

As the train continues toward Vancouver, witness the beautiful and incredibly picturesque views of the Canadian Rockies from the comfort and convenience of the train. Crystal clear mountain lakes, majestic peaks, and ancient glaciers are all part of your adventure through the mountains!

**DAY 6 - VANCOUVER**

Upon arrival in Vancouver, check in for a two-night stay. Spend the rest of the day exploring on your own.

**DAY 7 - VANCOUVER**

Use your included hop-on, hop-off sightseeing tour today to discover the best sights of Vancouver including Gastown and Stanley Park. Also included today is admission to the Vancouver Lookout, offering panoramic, 360-degree views of the entire city.

**DAY 8 - YOUR JOURNEY ENDS  
IN VANCOUVER**

VIA Rail

# ULTIMATE CANADA COAST TO COAST

Halifax → Quebec City → Montreal → Toronto → Niagara Falls  
→ Jasper → Banff → Vancouver

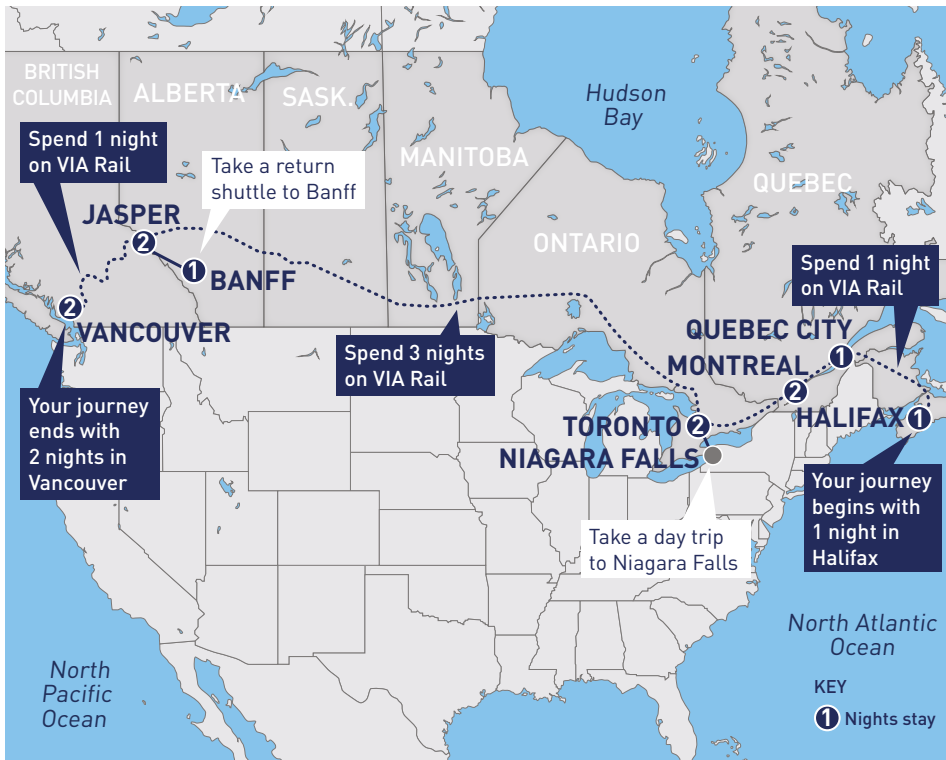

18 DAYS

CLICK HERE FOR MORE  
INFORMATION ON THIS TRIP**VACATION INCLUDES:**

- One-way VIA Rail® in Economy accommodations from Halifax to Quebec City, Quebec City to Montreal, Montreal to Toronto, and Vancouver onboard The Ocean® and The Canadian®
- 12 nights' accommodations; 5 nights' onboard VIA Rail
- 3 meals included (2 lunches and 1 dinner)
- Sightseeing city tour of Quebec City, Montreal, Niagara Falls from Toronto and the Columbia Icefield and Athabasca Glacier including the Glacier Skywalk
- Hop-on, hop-off sightseeing tour of Vancouver
- Admission to the Vancouver Lookout

**FEATURED ACCOMMODATION****Halifax** - Hampton Inn by Hilton Halifax**Quebec City** - Hotel Chateau Laurier**Montreal** - Le Novel Hotel & Spa**Toronto** - Chelsea Hotel**Jasper** - Chateau Jasper**Banff** - Elk and Avenue**Vancouver** - Hampton Inn & Suites by Hilton, Downtown VancouverHotels are subject to availability.  
Alternatives may be used.**DAY 1 - YOUR JOURNEY BEGINS  
IN HALIFAX**

Enjoy the town's charming seaside areas. Find a great restaurant for dinner by the water.

**DAY 2 - OVERNIGHT ONBOARD VIA RAIL**

You have some of the morning free to complete your visit to Halifax. Head over to the VIA Rail station to depart for Quebec City. You'll be treated to some delightful views of the rocky and forested coast and inlands of the region.

**DAY 3 - QUEBEC CITY**

Quebec City's early colonial roots are everywhere from its centuries old defensive walls, its continental-flavored Old Port district, to the historic waterfront. Dinner tonight is included at a classic Quebecois restaurant.

**DAY 4 - QUEBEC CITY**

Included today is a guided tour of Quebec City. You'll visit historic points of interest such as the Latin Quarter, Plains of Abraham, the Ramparts, the world-famous Château Frontenac hotel, Place-Royale, and the Citadelle.

**DAY 5 - QUEBEC CITY TO MONTREAL**

Board the train today and continue on to Montreal.

**DAY 6 - MONTREAL**

Your included tour today will provide an excellent experience of the city. Included in the guided

sightseeing experience are famous attractions like Notre Dame Basilica, the hip Place des Arts, Place Jacques Cartier, the Hotel de Ville, and Old Montreal.

**DAY 7 - MONTREAL TO TORONTO**

Take the train over to Toronto and start exploring Yorkville, Cabbagetown, and The Annex.

**DAY 8 - TORONTO TO NIAGARA FALLS**

Carved by the glaciers of the last ice age and mighty flow of the St. Lawrence River and Great Lakes, Niagara falls roar with as much as 2,800 cubic meters of water pouring over the edge every second! Enjoy lunch overlooking the falls.

**DAY 9 - OVERNIGHT ONBOARD VIA RAIL**

Travel to the VIA Rail station and board the iconic Canadian Line for your exciting three-day trip across Canada.

**DAY 10 & 11 - OVERNIGHT ONBOARD  
VIA RAIL**

Enjoy traveling through a variety of beautiful landscapes and taking in sights only possible by train.

**DAY 12 - JASPER**

After the train rides into the heart of the mountains, it will arrive in the picturesque mountain community of Jasper. Travel on your own to your hotel and check in.

**DAY 13 - JASPER TO BANFF**

This morning, you will depart Jasper for a scenic drive out to Banff. Your ride along the world-famous Icefields Parkway will be full of gorgeous sights. Step onboard an Ice Explorer for an interpretive adventure on the Athabasca Glacier.

**DAY 14 - BANFF TO JASPER**

You will be transferred today from Banff through the mountains and back to Jasper. Rest and relax before tomorrow's train journey to the West Coast.

**DAY 15 - OVERNIGHT ONBOARD VIA RAIL**

This morning, board VIA Rail's Canadian to continue your journey through the majestic Canadian Rockies. Enjoy dinner as the train whisks you past Moose Lake and the peaks of Mt. Robson and the Monashee Mountains.

**DAY 16 - VANCOUVER**

Head to the dining car this morning for a freshly prepared breakfast and enjoy the stunning views of central British Columbia. Upon arrival in Vancouver, check in at your hotel for a two-night stay

**DAY 17 - VANCOUVER**

Today, continue on with your sightseeing tour and experience the best of what Vancouver has to offer.

**DAY 18 - YOUR JOURNEY ENDS  
IN VANCOUVER**

# GRAND EASTERN CANADIAN RAIL JOURNEY

Toronto → Niagara Falls → Ottawa → Montreal → Quebec City → Halifax



**11 DAYS****CLICK HERE FOR MORE  
INFORMATION ON THIS TRIP****VACATION INCLUDES:**

- 9 nights' hotel stay
- 1 night onboard VIA Rail®
- One-way VIA Rail® in Economy class
- 1 meal (1 lunch)
- Multi-day hop-on, hop-off sightseeing tour of Toronto
- Sightseeing tour of Niagara Falls and Niagara-on-the-Lake
- Hop-on, hop-off sightseeing tour of Ottawa
- Sightseeing city tour of Montreal
- Sightseeing city tour of Quebec City
- Sightseeing tour of Peggy's Cove

Note: Some tours and activities are seasonal and not available on all travel days.

**FEATURED ACCOMMODATION**

**Toronto** - Chelsea Hotel

**Ottawa** - Lord Elgin

**Montreal** - Le Novel Hotel & Spa

**Quebec City** - Hotel Chateau Laurier

**Halifax** - Hampton Inn by Hilton Halifax

Hotels are subject to availability.

Alternatives may be used.

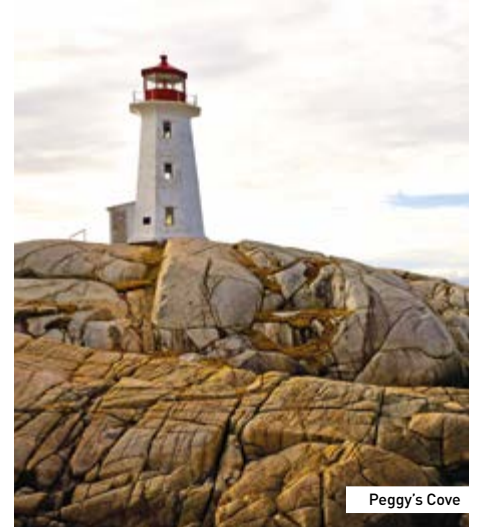

Peggy's Cove

**DAY 1 - ARRIVE IN TORONTO**

Welcome to Canada! Begin exploring Toronto, Canada's largest city and one of the most culturally diverse, at your leisure.

**DAY 2 - TORONTO**

Enjoy a full day of sightseeing with your hop-on, hop-off sightseeing tour. Visit popular sites such as the Royal Ontario Museum, Casa Loma, the Hockey Hall of Fame, Toronto Harbourfront, Eaton Centre and Chinatown.

**DAY 3 - TORONTO TO NIAGARA FALLS**

Enjoy a full-day sightseeing tour of Niagara Falls and Niagara-on-the-Lake today. With as much as 2,800 cubic meters of water pouring over the edge every minute, it is sure to impress! Highlights of your day include a boat cruise up close to the falls, exploring the caverns behind the falls and lunch overlooking the falls. Witness the beauty and majesty of the falls from all angles!

**DAY 4 - TORONTO TO OTTAWA**

Hop on board VIA Rail for a quick and comfortable ride to Ottawa today. Upon arrival in Ottawa, check in at your hotel and take advantage of your hop-on, hop-off sightseeing tour to uncover the many sights of the Canadian capital.

**DAY 5 - OTTAWA TO MONTREAL**

Enjoy another quick rail journey to Montreal today, and after checking in at your hotel, spend some time getting acquainted with this bustling, European-influenced city. Be sure to take a stroll along the picturesque cobbled streets of Old Montreal, taking in the many architectural styles - a true juxtaposition of the old and the new.

**DAY 6 - MONTREAL**

Today, enjoy a guided tour that will take you all around old and new Montreal. Your tour will bring you to such popular attractions as the Olympic Stadium, Basilica Notre Dame, and Place Jacques Cartier. Let the distinct history and the culture of the city sink in as you enjoy your tour.

**DAY 7 - MONTREAL TO QUEBEC CITY**

Today you will continue your Canadian Rail Journey and head further east to Quebec City. After checking in at your hotel, begin exploring this fascinating destination, also known for its European feel and French-Canadian history.

**DAY 8 - OVERNIGHT ONBOARD VIA RAIL**

Continuing exploring Quebec City today at your leisure. Tonight, board VIA Rail's Ocean train line, passing distant lights marking small towns as you travel even further east to Halifax. Settle into your comfortable onboard accommodations and enjoy a good night's rest.

**DAY 9 - HALIFAX**

Enjoy a relaxing day on the train. The scenery will be breathtaking as you enter rustic New Brunswick and then Nova Scotia. Descend the coast of the Baie-des-Chaleurs, and later this afternoon pass Moncton and arrive into maritime Halifax for a two-night stay.

**DAY 10 - HALIFAX**

Today, enjoy a sightseeing tour of Peggy's Cove, a picture-perfect coastal village and artists' haven that is also home to the most photographed lighthouse in the world.

**DAY 11 - YOUR JOURNEY ENDS  
IN HALIFAX**

Quebec City

# QUEBEC AND THE MARITIMES RAIL JOURNEY

Montreal → Quebec City → Halifax

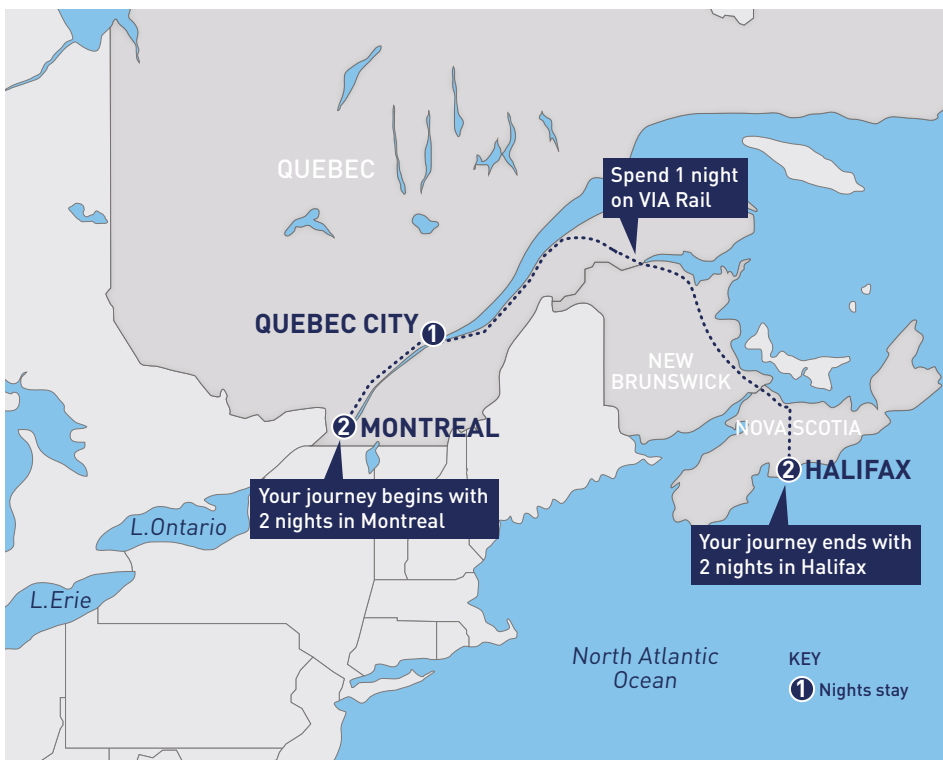

Montreal



## 7 DAYS

**CLICK HERE FOR MORE INFORMATION ON THIS TRIP**

### VACATION INCLUDES:

- 5 nights' hotel stay
- 1 night onboard VIA Rail®
- One-way VIA Rail® in Economy class
- 1 meal (1 dinner)
- Sightseeing city tour of Montreal
- Sightseeing city tour of Quebec City
- Sightseeing tour of Peggy's Cove

Note: Some tours and activities are seasonal and not available on all travel days.

### FEATURED ACCOMMODATION

**Montreal** - Le Novel Hotel & Spa

**Quebec City** - Hotel Chateau Laurier

**Halifax** - Hampton Inn by Hilton Halifax

Hotels are subject to availability. Alternatives may be used.

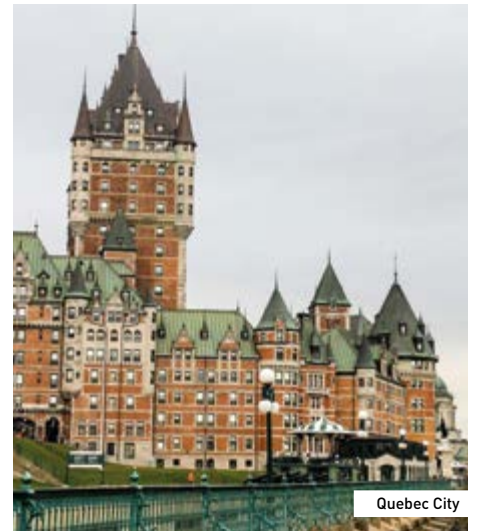

Quebec City

### DAY 1 - ARRIVE IN MONTREAL

Welcome to Montreal! Experience the city that is an interesting blend of the Old World and the new, the historic and modern! Spend some time exploring this amazing city on your own.

### DAY 2 - MONTREAL

Today you will have a guided tour that will direct you all around Montreal. Your tour will bring you to such popular attractions as the Olympic Stadium, Basilica Notre Dame and Place Jacques Cartier. Let the history and the culture of the city sink in as you enjoy your tour.

### DAY 3 - MONTREAL TO QUEBEC CITY

Today you will reach Quebec City. You arrive early with a full day to explore this fascinating destination. The city's early colonial roots are on display everywhere, from its centuries old defensive walls and its continental-flavored Old Port district, to the historic waterfront. Dinner tonight is included at a classic Quebecoise restaurant.

### DAY 4 - OVERNIGHT ONBOARD VIA RAIL

Continue to explore the city. Included today is a guided tour of Quebec City. Your guide will provide

some amazing stories and background on the town while riding past popular and historic points of interest such as the Latin Quarter, Plains of Abraham, the Ramparts, the world-famous Château Frontenac hotel, Place-Royale, and the Citadelle. In the evening, travel on your own to the VIA Rail station and hop on board your train for an exciting journey to Halifax!

### DAY 5 - HALIFAX

Enjoy a relaxing day on the train. The scenery will be breathtaking as you enter the Canadian Maritimes Region of Canada. Later this afternoon, arrive into Halifax and travel to the hotel for a two-night stay.

### DAY 6 - HALIFAX

Spend the final day of your journey touring Peggy's Cove, home to the most photographed lighthouse in the world, perched on the rocks overlooking the rugged Atlantic coastline.

### DAY 7 - YOUR JOURNEY ENDS IN HALIFAX



Halifax

# QUEBEC CITY AND HALIFAX FROM MONTREAL

Montreal → Quebec City → Halifax



**6 DAYS**  
**CLICK HERE FOR MORE INFORMATION ON THIS TRIP**

**VACATION INCLUDES:**

- 4 nights' hotel stay
- 1 night onboard VIA Rail®
- One-way VIA Rail® in Economy class
- 1 meal (1 dinner)
- Sightseeing city tour of Quebec City
- Sightseeing tour of Peggy's Cove

Note: Some tours and activities are seasonal and not available on all travel days.

**FEATURED ACCOMMODATION**

**Quebec City** - Hotel Chateau Laurier  
**Halifax** - Hampton Inn by Hilton Halifax  
 Hotels are subject to availability. Alternatives may be used.



**DAY 1 - MONTREAL TO QUEBEC CITY**

Depart Montreal and head for Quebec City! Arrive early with a full day to explore this fascinating destination. The city's early colonial roots are everywhere from its centuries old defensive walls, its continental-flavored Old Port district, to the historic waterfront.

**DAY 2 - QUEBEC CITY**

Today is free for you to explore all that Quebec City has to offer. Visit tops sites like the Montmorency Falls or even Old Port. Dinner tonight is included at a classic Quebecoise restaurant.

**DAY 3 - OVERNIGHT ONBOARD VIA RAIL**

Continue to explore Quebec City today with a guided tour of the city. Your guide will provide some amazing stories and background on the town while riding past popular and historic points of interest such as the Latin Quarter, Plains of Abraham, the Ramparts, the world-famous Château Frontenac hotel, Place-Royale, and the Citadelle. In the evening, travel on your own to the

VIA Rail station and hop on board your train for an exciting journey to Halifax!

**DAY 4 - HALIFAX**

Enjoy a relaxing day on the train today. The scenery will be breathtaking as you enter the Canadian Maritimes Region of Canada. Later this afternoon, arrive into Halifax and travel to the hotel.

**DAY 5 - HALIFAX**

Spend the final day of your journey touring Peggy's Cove, home to the most photographed lighthouse in the world, perched on the rocks overlooking the rugged Atlantic coastline.

**DAY 6 - YOUR JOURNEY ENDS IN HALIFAX**

# ULTIMATE QUEBEC CITY AND HALIFAX FROM TORONTO

Toronto ➔ Quebec City ➔ Halifax



**8 DAYS**  
**CLICK HERE FOR MORE INFORMATION ON THIS TRIP**

**VACATION INCLUDES:**

- 6 nights' hotel stay
- 1 night onboard VIA Rail®
- One-way VIA Rail® in Economy class
- 1 meal (1 dinner)
- Sightseeing city tour of Quebec City
- Sightseeing tour of Peggy's Cove

Note: Some tours and activities are seasonal and not available on all travel days.

**FEATURED ACCOMMODATION**

**Quebec City** - Hotel Chateau Laurier  
**Halifax** - Hampton Inn by Hilton Halifax  
 Hotels are subject to availability. Alternatives may be used.



**DAY 1 - TORONTO TO QUEBEC CITY**

Depart Toronto and make your way to Quebec City! Upon arrival, check in at your hotel and begin exploring the city.

**DAY 2 - QUEBEC CITY**

Continue to explore Quebec City today with a guided tour. Your guide will provide some amazing stories and background on the town while you ride past popular and historic points of interest such as the Latin Quarter, Plains of Abraham, the Ramparts, the world-famous Château Frontenac hotel, Place-Royale, and the Citadelle.

**DAY 3 - QUEBEC CITY**

Today, Quebec City is still yours to discover! You have another full day to explore this fascinating destination. The city's early colonial roots are everywhere, from its centuries old defensive walls, its continental-flavored Old Port district, to the historic waterfront. Dinner tonight is included at a classic Quebecoise restaurant.

**DAY 4 - OVERNIGHT ONBOARD VIA RAIL**

In the evening, travel on your own to the VIA Rail station and hop on board your train for a relaxing overnight journey to Halifax!

**DAY 5 - HALIFAX**

Enjoy a relaxing day on the train. The scenery will be breathtaking as you enter rustic New Brunswick and then Nova Scotia. Descend along the coast of the Baie-des-Chaleurs, and later this afternoon pass Moncton and arrive into maritime Halifax for a three-night stay.

**DAY 6 - HALIFAX**

Today, enjoy discovering Halifax at your leisure. Learn about its maritime history, visit the Halifax Citadel National Historic Site, and check out the famous Public Gardens. Later, take a leisurely stroll along the waterfront boardwalk and explore the unique shops, or dine in one of the many restaurants where you can enjoy some of the freshest seafood around.

**DAY 7 - HALIFAX**

Today, take a special detour out to Peggy's Cove, the picture postcard village famous for Peggy's Point Lighthouse. On the way, you'll experience amazing views of Nova Scotia's unique coastline, full of history and culture. Perched on solid rock above the crashing surf, Peggy's Cove has been an artists' and explorers' paradise for well over 150 years, and offers visitors a full day of sightseeing and shopping.

**DAY 8 - YOUR JOURNEY ENDS IN HALIFAX**



# EASTERN CANADA RAIL JOURNEY

Toronto → Niagara Falls → Ottawa → Montreal → Quebec City



Montreal



Quebec City



Ottawa

**9 DAYS**

**CLICK HERE FOR MORE INFORMATION ON THIS TRIP**

**VACATION INCLUDES:**

- 8 nights' hotel stay
- One-way VIA Rail® in Economy class
- 2 meals included (1 lunch, 1 dinner)
- Sightseeing tour of Niagara Falls and Niagara-on-the-Lake
- Multi-day hop-on, hop-off sightseeing tour of Toronto
- Hop-on, hop-off sightseeing tour of Ottawa
- Sightseeing city tour of Montreal
- Sightseeing city tour of Quebec City

Note: Some tours and activities are seasonal and not available on all travel days.

**FEATURED ACCOMMODATION**

**Toronto** - Chelsea Hotel

**Ottawa** - Lord Elgin

**Montreal** - Le Nouvel Hotel & Spa

**Quebec City** - Hotel Chateau Laurier

Hotels are subject to availability.

Alternatives may be used.



Toronto

**DAY 1 - ARRIVE IN TORONTO**

Welcome to Toronto! Today you have free time to explore this energetic, cosmopolitan city known for its arts and culture.

**DAY 2 - NIAGARA FALLS**

Spend the day today exploring one of the wonders of the natural world, Niagara Falls. Enjoy a boat cruise taking you right up to the mighty American, Bridal Veil and Horseshoe Falls where you'll hear the thundering roar of the falls and feel the refreshing mist. Enjoy lunch with views overlooking the falls and stop in Niagara's wine region for a wine tasting.

**DAY 3 - TORONTO**

Discover Toronto today on a hop-on, hop-off sightseeing tour. Enjoy iconic Toronto locations including the Royal Ontario Museum, St. Lawrence Market, the second largest Chinatown in North America, and Eaton Centre where you will find more than 250 shops and the Hockey Hall of Fame!

**DAY 4 - OTTAWA**

Travel on VIA Rail's Corridor service to Ottawa, Canada's nation's capital steeped in rich history and culture. Use your hop-on, hop-off sightseeing tour to visit Parliament Hill, the Notre-Dame Basilica, and the Canadian Aviation Museum.

**DAY 5 - OTTAWA TO MONTREAL**

Today you will board VIA Rail for the short journey to Montreal. Enjoy comfortable accommodations and delicious food onboard the train. Upon arrival in Montreal, check in at your hotel for a two-night stay in this beautiful Eastern Canadian city.

**DAY 6 - MONTREAL**

Today, enjoy a guided sightseeing tour of Montreal. The tour will bring you to major city landmarks such as the historic Old Montreal, Olympic Stadium, and Notre Dame Basilica. Let the history and the culture of the city sink in as you enjoy your tour.

**DAY 7 - MONTREAL TO QUEBEC CITY**

This morning board the train for your journey up to Quebec City. Sit back and relax as you travel on Canada's national railroad.

**DAY 8 - QUEBEC CITY**

Explore Quebec City and learn about its history and distinctive European ambience that visitors fall in love with. Your guided tour will bring you to Place Royale, Old Quebec, and the Le Chateau Frontenac. Tonight, your dinner is included at a popular, local restaurant.

**DAY 9 - YOUR JOURNEY ENDS IN QUEBEC CITY**



Niagara Falls

# ACCOMMODATIONS

## SLEEPER PLUS UPGRADES ON THE CANADIAN STAINLESS STEEL EQUIPMENT

Upgrade to Sleeper Plus to experience all The Canadian has to offer including a range of comfortable accommodations, showers, freshly prepared meals, access to multiple domed lounge cars and a range of onboard activities including wine tastings and interactive talks on local history, geography and culture.

### ■ BERTHS

Are open by day - two couch-style seats facing each other. By night, berths convert to curtained, private compartments with two stacked beds. Use of public washroom.

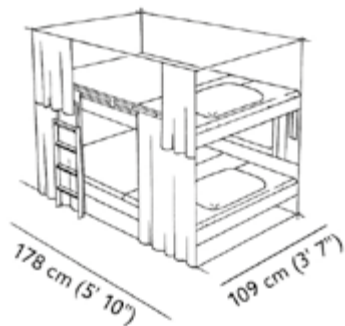

### ■ CABIN FOR ONE

Private room featuring a small couch-style seat that converts into a bed, with a concealed toilet and vanity.

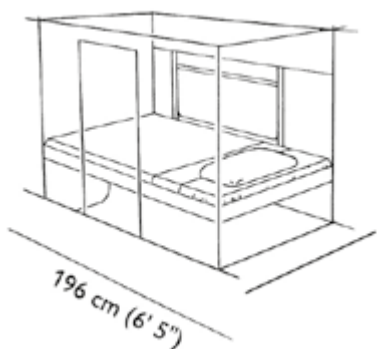

### ■ CABIN FOR TWO

Private room with two armchairs, two retractable stacked beds, a vanity and ensuite toilet.

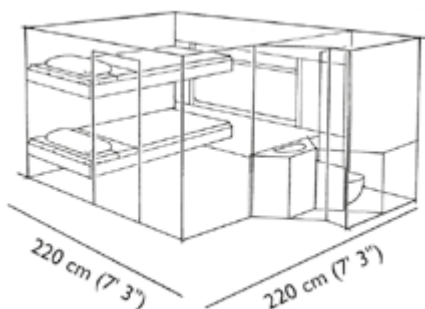

# ACCOMMODATIONS

## PRESTIGE CLASS - THE VERY BEST ON THE CANADIAN

Upgrading to Prestige ensures you'll have the very best of the amenities available on The Canadian. From larger rooms with private shower, personalized concierge attendants, exclusive access to dome car seating, all-inclusive beverages and enhanced meal service, Prestige class sets the bar for overnight rail travel in North America.

### ■ PRESTIGE CLASS

Provides an unforgettable rail experience.

- Spacious cabin - 50% larger than a cabin for two in Sleeper Plus class, with a wide viewing window that is 60% larger
- Modular leather L-shaped couch by day and a Murphy bed for two by night
- Private washroom with shower
- Flat-screen monitor with video selection
- Minibar stocked with a selection of beverages
- Complimentary bar service
- Electric radiant-heated cabin
- Priority seating in the dining car
- Dedicated Concierge attendant throughout the trip

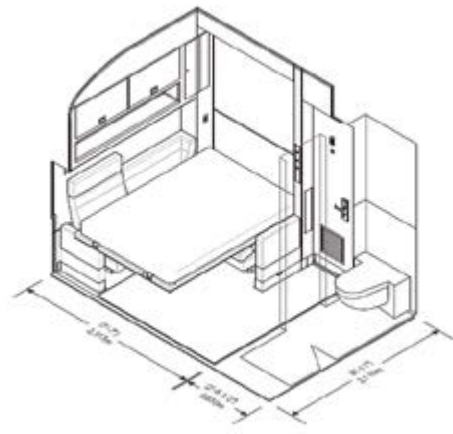

## SLEEPER PLUS CLASS - ON THE OCEAN: RENAISSANCE AND STAINLESS STEEL EQUIPMENT

Upgrade to Sleeper Plus to experience the best of The Ocean including comfortable accommodations, private showers, Atlantic inspired meals and access to the domed Park car.

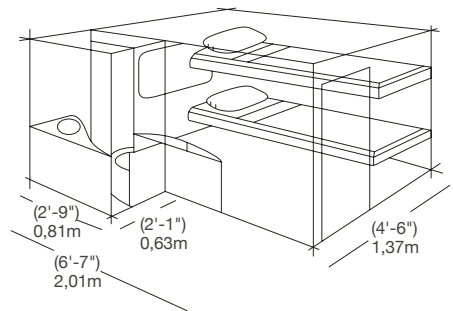

## OUR RAIL PARTNERS



## HOW TO BOOK

Call **1-888-829-3040**

Visit **[www.railbookers.com](http://www.railbookers.com)**

Call your **local Travel Agent**

# railbookers