

5-8  
ans

*inspiré de la pédagogie*

**MONTESSORI**

# MON MANUEL D'ÉCRITURE

**J'APPRENDS L'ALPHABET**

AVEC LES MOTS DE L'ISLAM

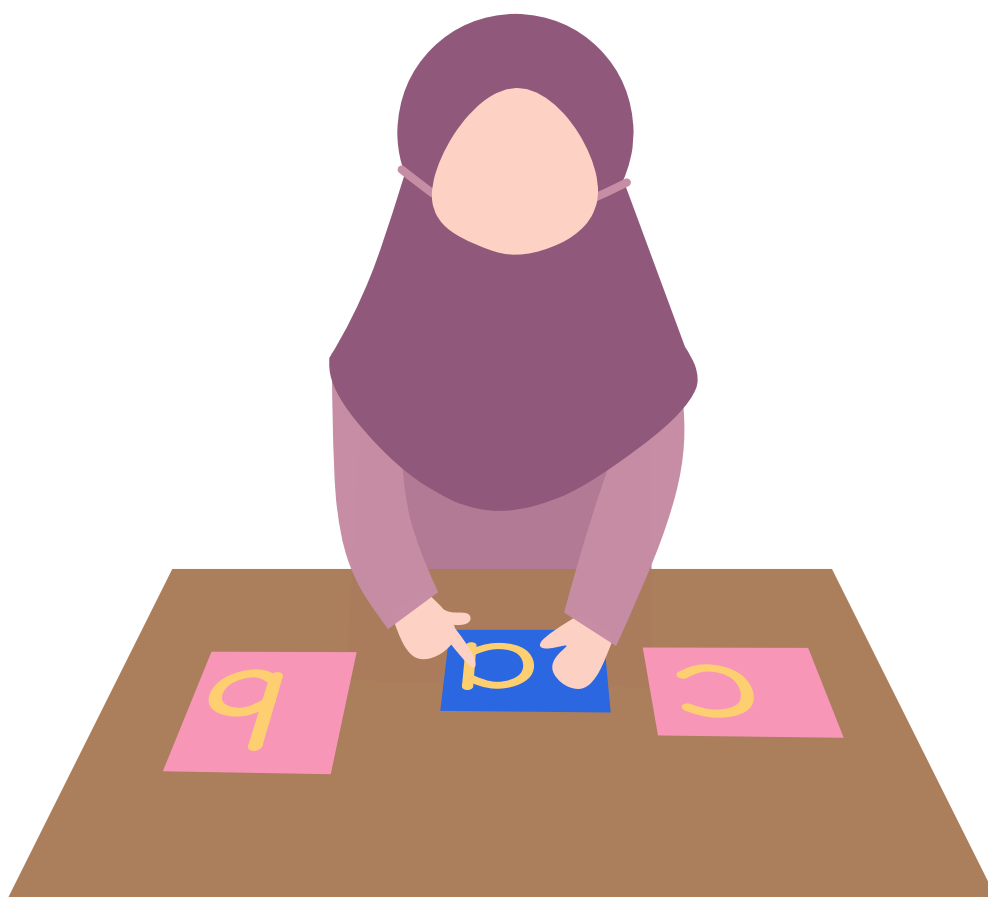

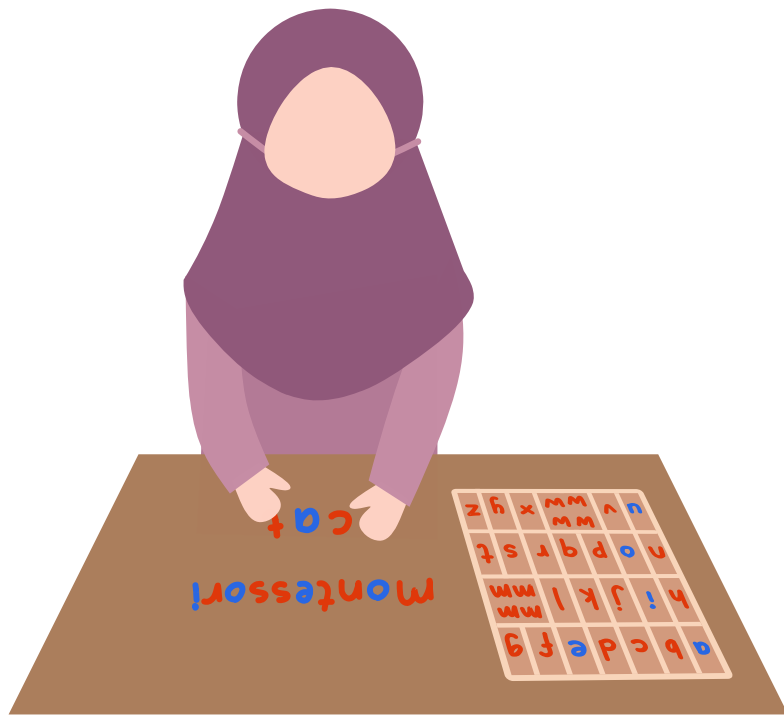

# J'APPRENDS L'ALPHABET

## AVEC LES MOTS DE L'ISLAM

Imaginé par *Adam & Oum Adam*  
Conceptualisé par *Abou & Oum Adam*  
Réalisé par *Adam & Oum Adam*

# CONSEILS PÉDAGOGIQUES POUR UNE UTILISATION RÉUSSIE DU MANUEL

---

Bienvenue dans le manuel d'écriture  
**"J'apprends l'alphabet avec les mots de  
l'islam"** conçu pour les enfants de 5 à 8 ans.

Ce support éducatif a été inspirée par la  
**pédagogie Montessori.**

Oum Adam, enseignante en FLE et maman  
en IEF depuis 2012, accompagné d'Adam -  
collégien en IEF et multi-dys, ont élaboré ce  
manuel dans l'objectif de rendre  
l'apprentissage de l'alphabet français  
instructif, ludique et adapté aux besoins  
individuels de chaque enfant.

Pour vous aider à prendre main les activités  
proposées, et afin d'en tirer tous les  
bénéfices, **voici quelques conseils utiles à  
lire avant de débiter avec votre Minimuz.**

# LA PÉDAGOGIE MONTESSORI DANS NOTRE MANUEL D'ÉCRITURE

---

## **1. Apprentissage individualisé :**

Avec la pédagogie Montessori, chaque enfant progresse à son propre rythme. Notre manuel d'écriture s'adapte à cette approche en permettant aux enfants de s'engager avec les lettres à leur propre vitesse, en fonction de leurs besoins et de leurs compétences.

## **2. Favorise l'autonomie :**

La pédagogie Montessori encourage les enfants à devenir autonomes dans leur apprentissage. Notre manuel pédagogique permet à l'enfant de choisir des activités d'écriture qui l'intéressent et de travailler de manière autonome quand il le souhaite.

### **3. Utilisation de matériel sensoriel :**

La méthode Montessori met l'accent sur l'utilisation de matériel sensoriel concret pour faciliter l'apprentissage. Notre manuel d'écriture incorpore donc des photographies réelles - et non des illustrations, ce qui permet aux enfants d'associer visuellement les lettres et les mots aux objets du monde réel. Cela favorise une compréhension plus profonde et un apprentissage plus engageant.

### **4. Encourage la créativité :**

La pédagogie Montessori laisse place à la créativité et à l'exploration. En s'inspirant de notre manuel d'écriture, l'enfant peut tracer les lettres dans le sable par exemple. Vous pouvez également plastifier les lettres afin de les réutiliser, ou de faire travailler l'enfant avec des jouets, de la pâte à modeler ou autre avant de passer à l'outil scripteur. LA seule limite est votre imagination (et celle de votre petit bout).

## **5. Accélérer l'apprentissage de la lecture :**

L'approche Montessori se base sur le son des lettres et non le nom de celles-ci. de cette façon, nous avons choisi, pour chaque lettre, un mot qui débute par le son réel de la lettre. Par exemple, Coran pour C et non Cheval ou Citron. Pensez à bien répéter à l'enfant le son de la lettre au lieu de son nom. Ceci facilitera son entrée en lecture.

## **6. Initiation à l'Islam :**

Le manuel d'écriture "J'apprends l'alphabet avec les mots de l'islam" offre une occasion unique d'introduire le vocabulaire de l'Islam dès le plus jeune âge. Ainsi, pour chaque lettre, nous avons choisi un mot en lien avec l'Islam afin que l'enfant puisse les découvrir et les comprendre.

## **7. Amusez vous :**

Pas de pression ! Le but de ce manuel est de passer un moment ludique et agréable !

## Qui sommes-nous ?

Depuis 10 ans, la team Ummaty œuvre pour l'instruction et l'éducation des enfants.

Oum Adam, enseignante de FLE et maman IEF depuis 2012, a mis son expertise à votre service en élaborant ce manuel.

Mais, ce n'est pas tout, puisque, Adam - collégien en IEF et multi-dys, a également mis la main à la pâte pour vous proposer un support qui réponde parfaitement aux attentes de vos enfants (et aux vôtres).

Enfin, Abou Adam, co-fondateur d'Ummaty Shop et père de famille nombreuse en école à la maison, a, quant à lui, participé à la conceptualisation de ce manuel. Ceci, comme à son habitude pour chaque support proposé par Ummaty Shop et l'édition Ummaty Books depuis une décennie.

Nous espérons que notre travail vous plaira !

Ce manuel appartient à :

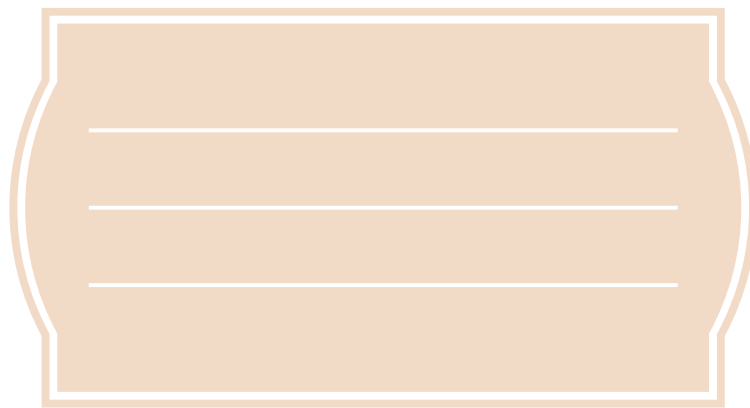

A decorative rectangular box with rounded corners and a double-line border. Inside the box, there are three horizontal lines, suggesting a space for writing a name or identifying information.

Nom: \_\_\_\_\_ Date: \_\_\_\_\_

# QUI SUIS-JE ?

Mon prénom est :

---

---

---

Voici les lettres de mon prénom :

a	b	c	d	e	f	g
h	i	j	k	l	m	n
o	p	q	r	s	t	u
v	w	x	y	z		

Que signifie mon prénom ?

Nom \_\_\_\_\_

Date \_\_\_\_\_

Repasse sur la lettre A / a

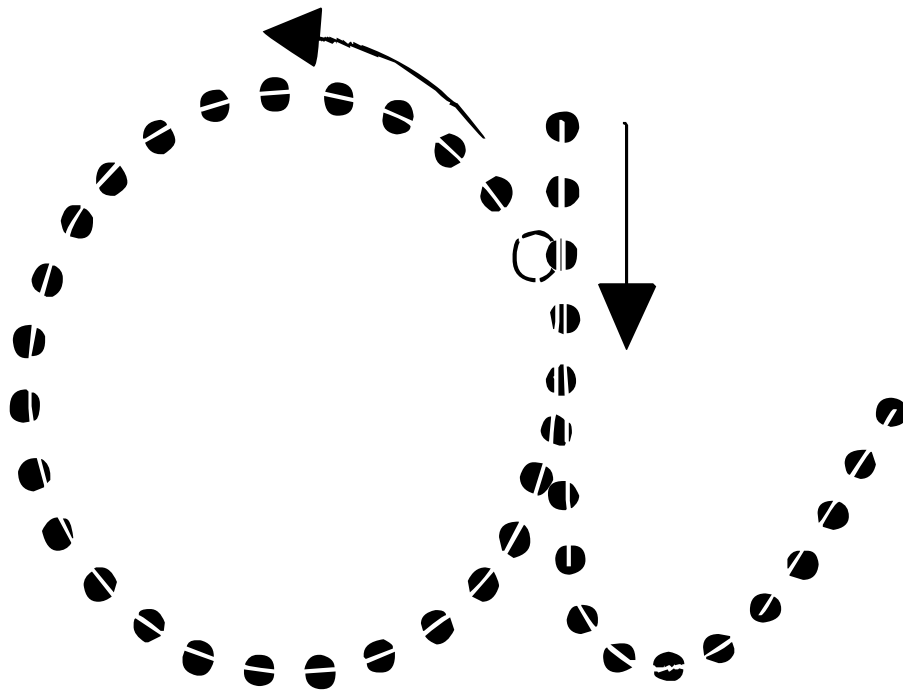

Nom \_\_\_\_\_

Date \_\_\_\_\_

Repasse sur la lettre A / a

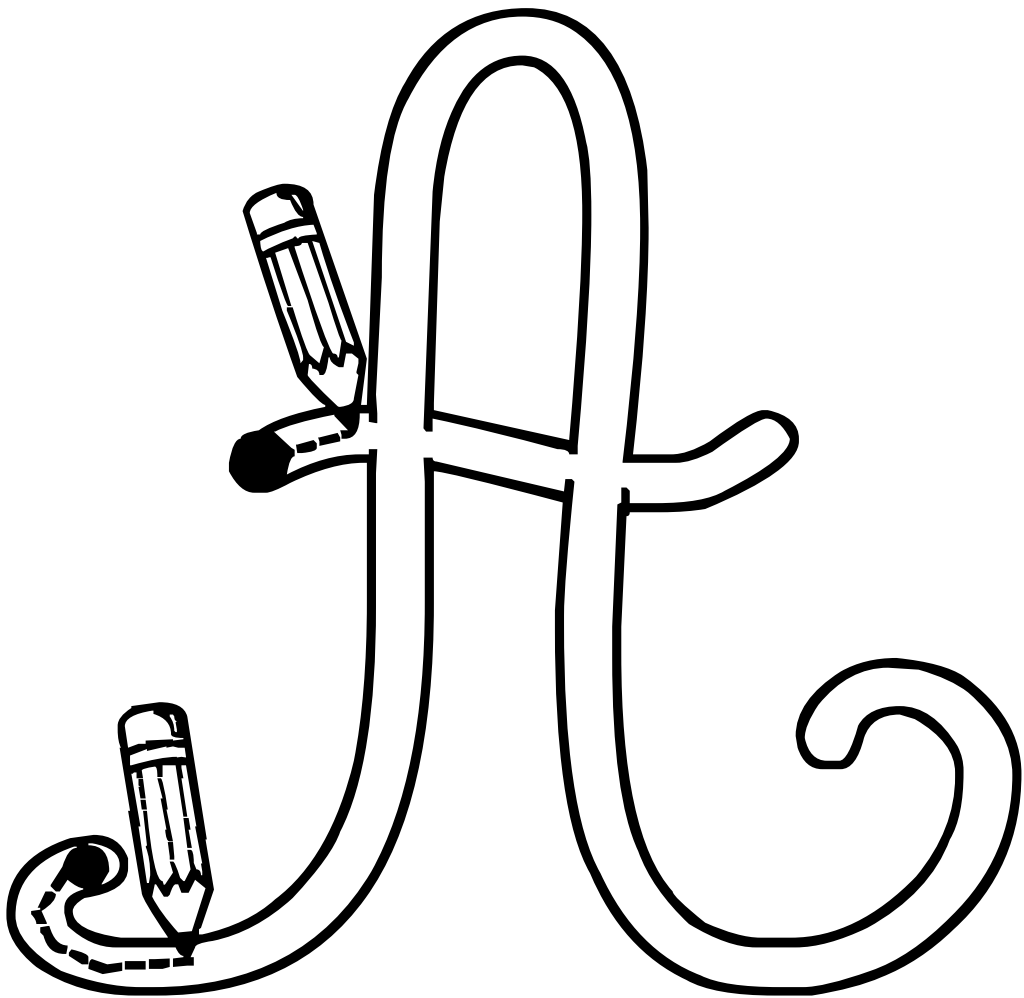

Nom \_\_\_\_\_

Date \_\_\_\_\_

Repasse sur la lettre A / a

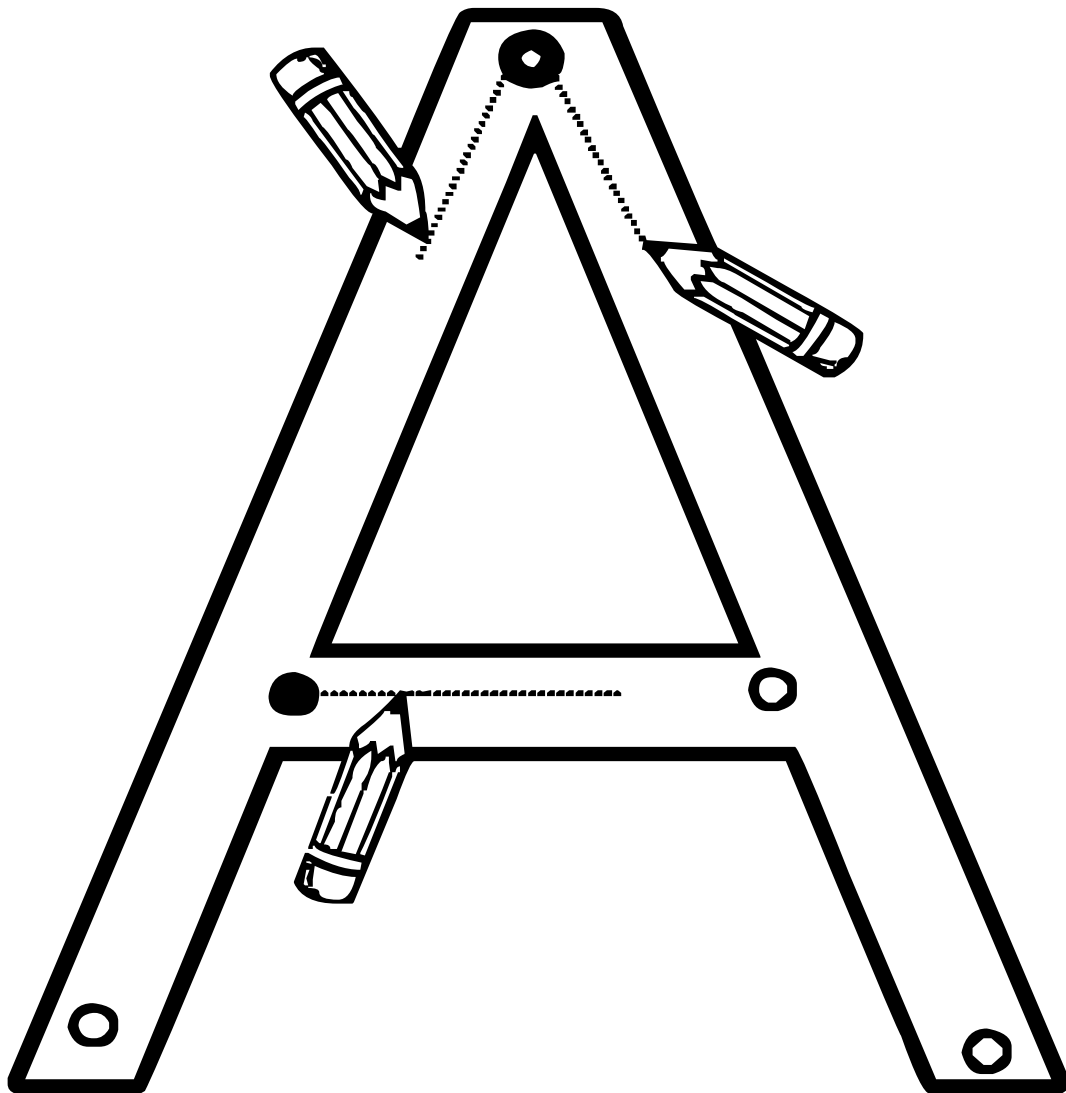

Nom \_\_\_\_\_ Date \_\_\_\_\_

## Ecris la lettre A / a

a a a a a a a

a a a a a a a

a a a a a a a

a a a a a a a

a a a a a a a

a a a a a a a

a a a a a a a

Nom \_\_\_\_\_

Date \_\_\_\_\_

# Ecris la lettre A / a

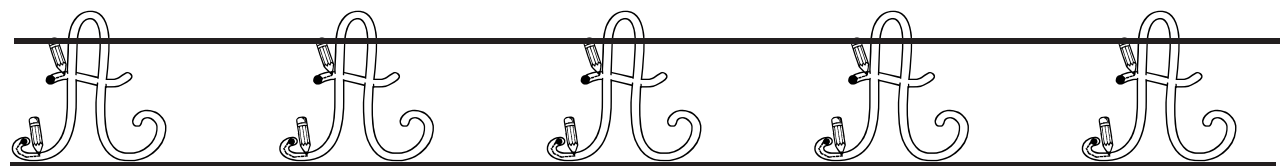
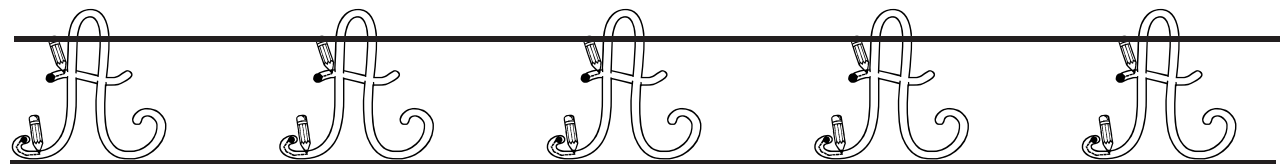
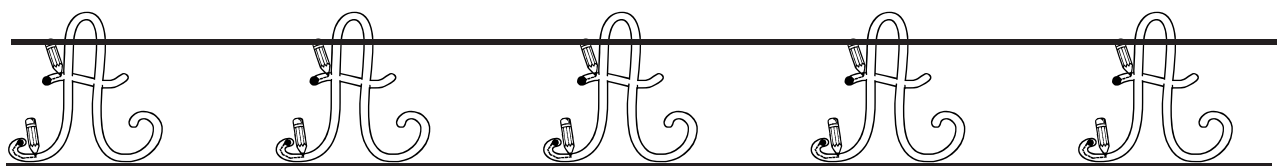
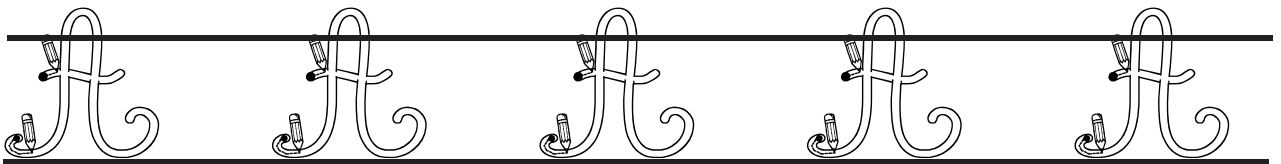
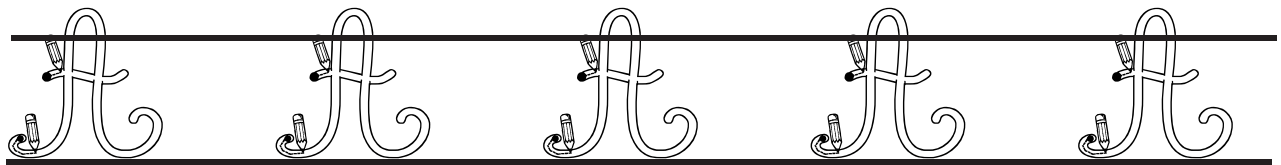
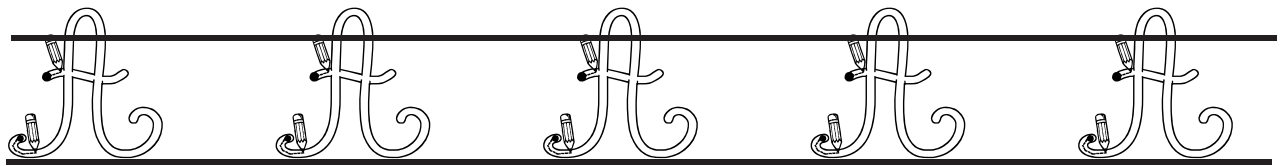
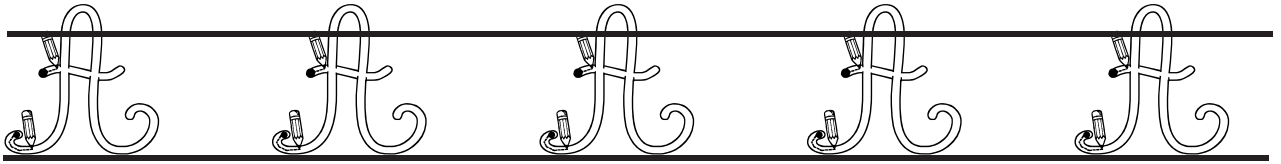

Nom \_\_\_\_\_ Date \_\_\_\_\_

# Ecris la lettre A / a

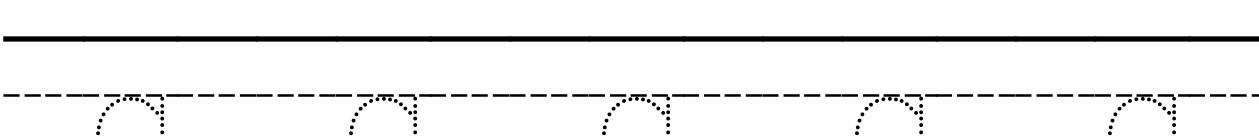
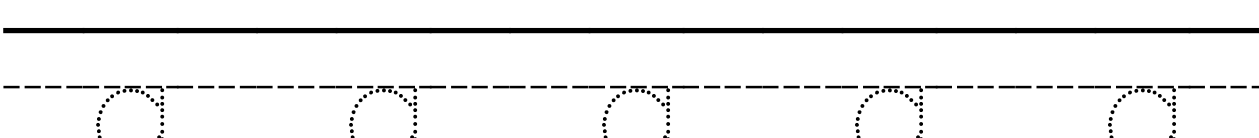
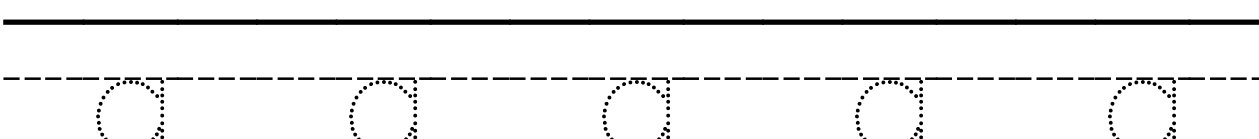
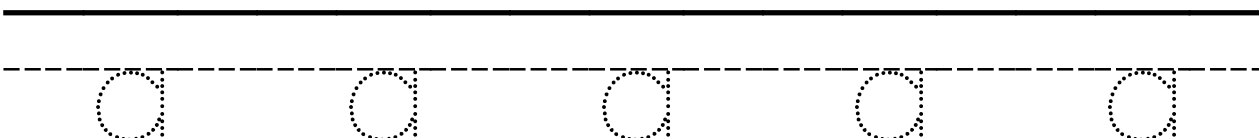
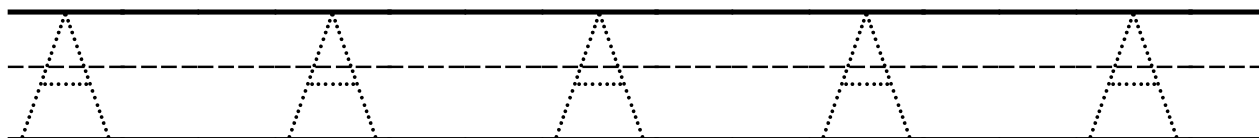
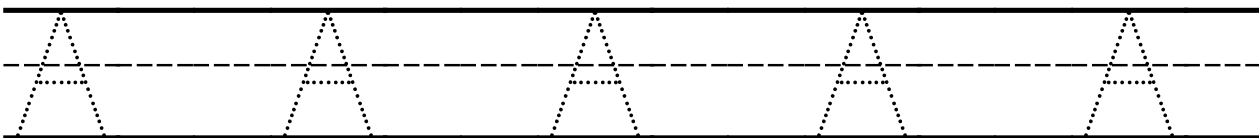
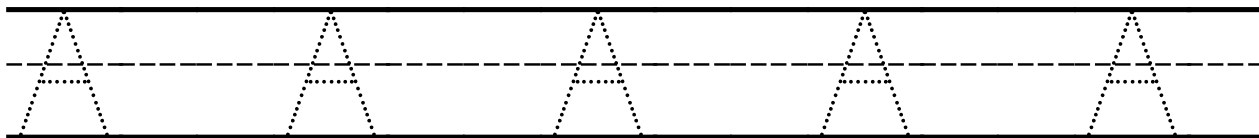
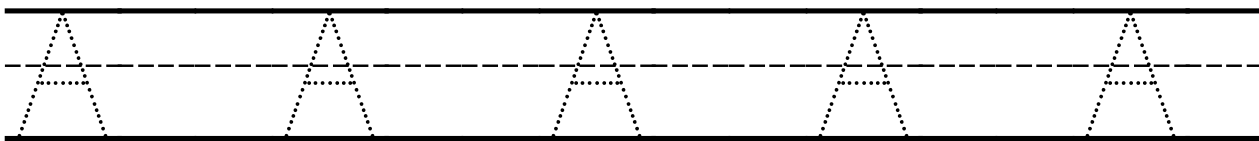

Nom \_\_\_\_\_ Date \_\_\_\_\_

Ecris la lettre A/a

A A A A A

Handwriting practice lines for uppercase letter A, consisting of two sets of four lines (top solid, middle dashed, bottom solid, bottom solid).

a a a a a

Handwriting practice lines for lowercase letter a, consisting of two sets of four lines (top solid, middle dashed, bottom solid, bottom solid).

Nom \_\_\_\_\_

Date \_\_\_\_\_

## Colorie la lettre A

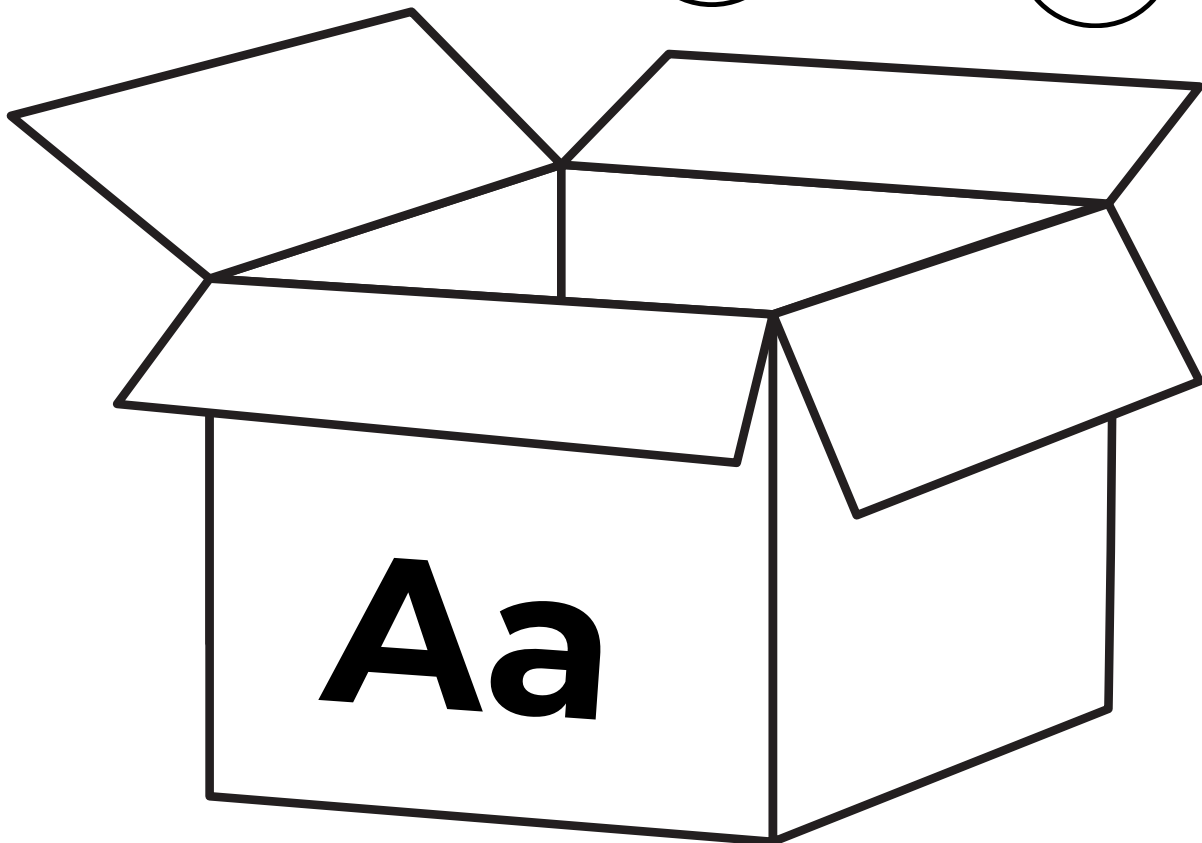
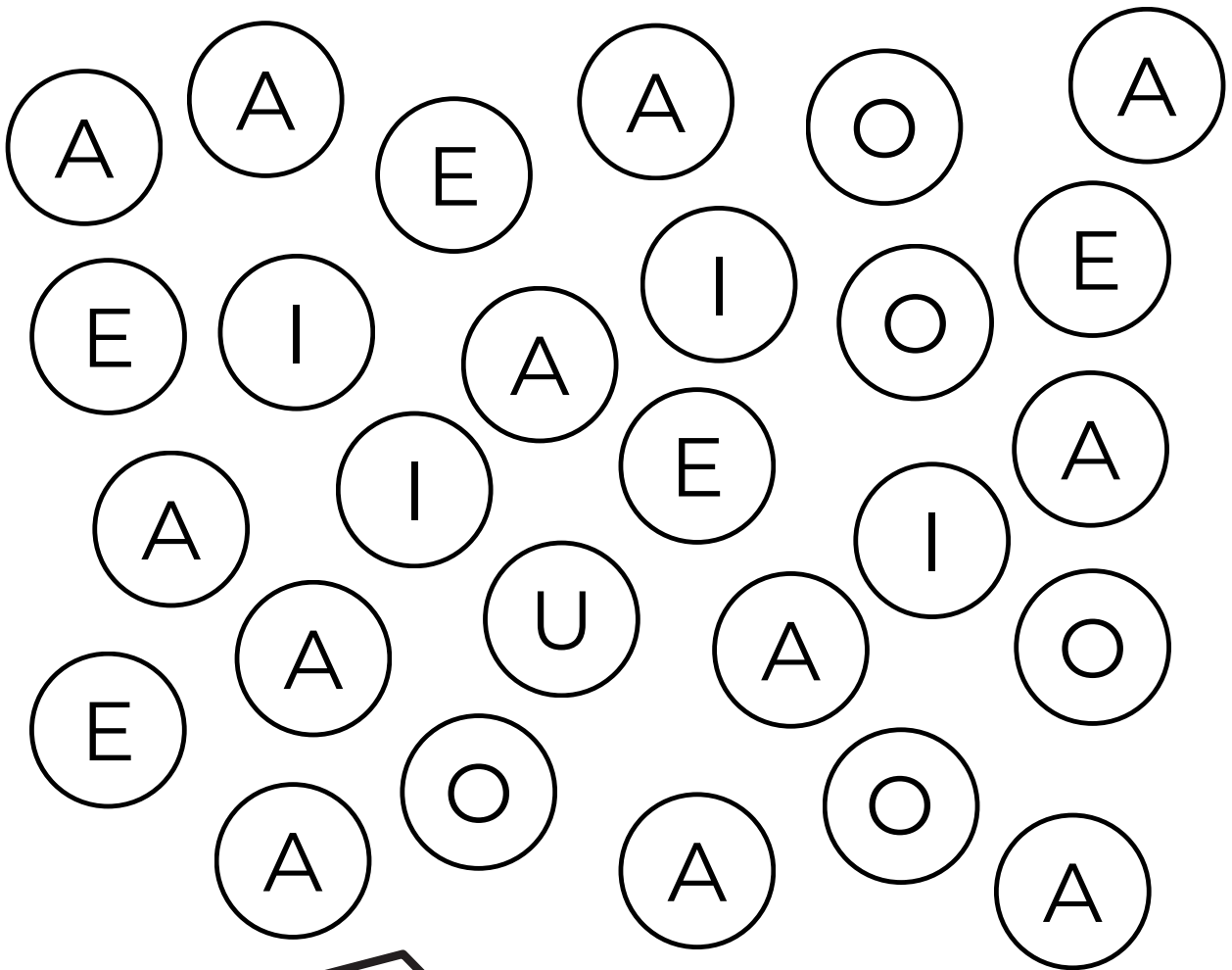

Nom \_\_\_\_\_

Date \_\_\_\_\_

Colorie la lettre a

o a e i a  
e e a e a u  
o u o o i a  
o o a i a  
o r a u  
i a  
a o  
o i



ARAIGNEE / araignée

Nom \_\_\_\_\_

Date \_\_\_\_\_

Repasse sur la lettre B / b

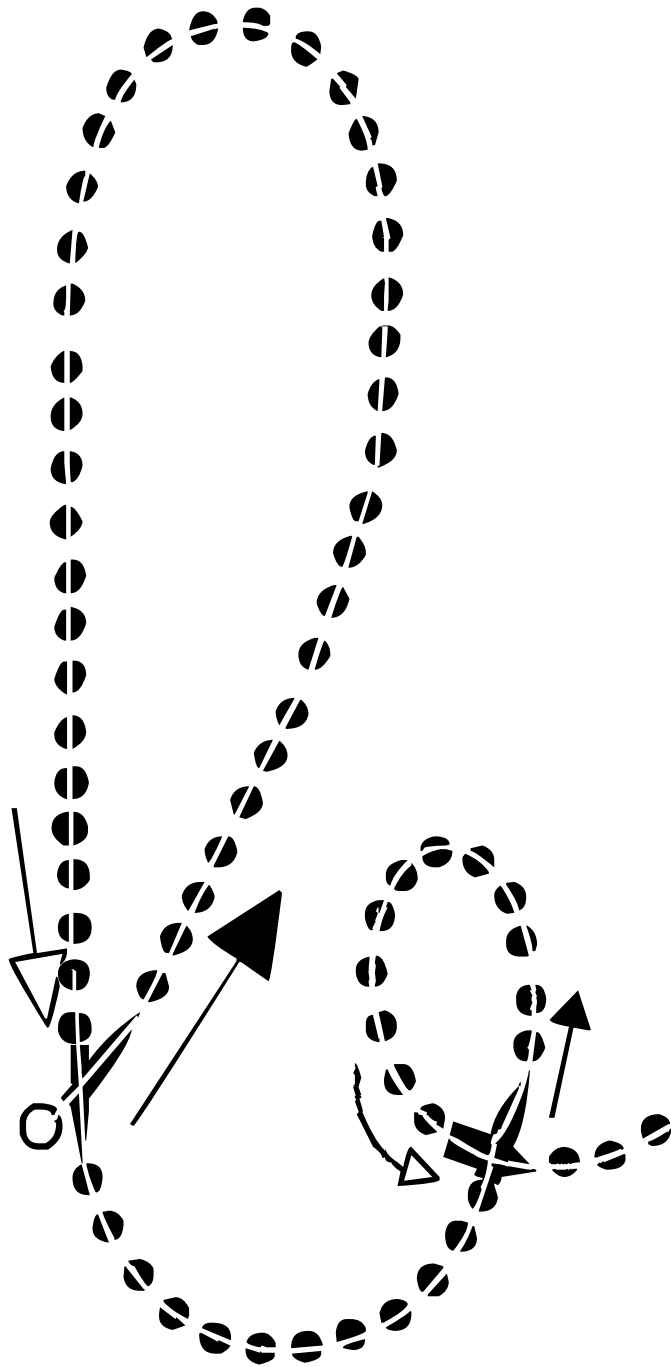

Nom \_\_\_\_\_

Date \_\_\_\_\_

Repasse sur la lettre B / b

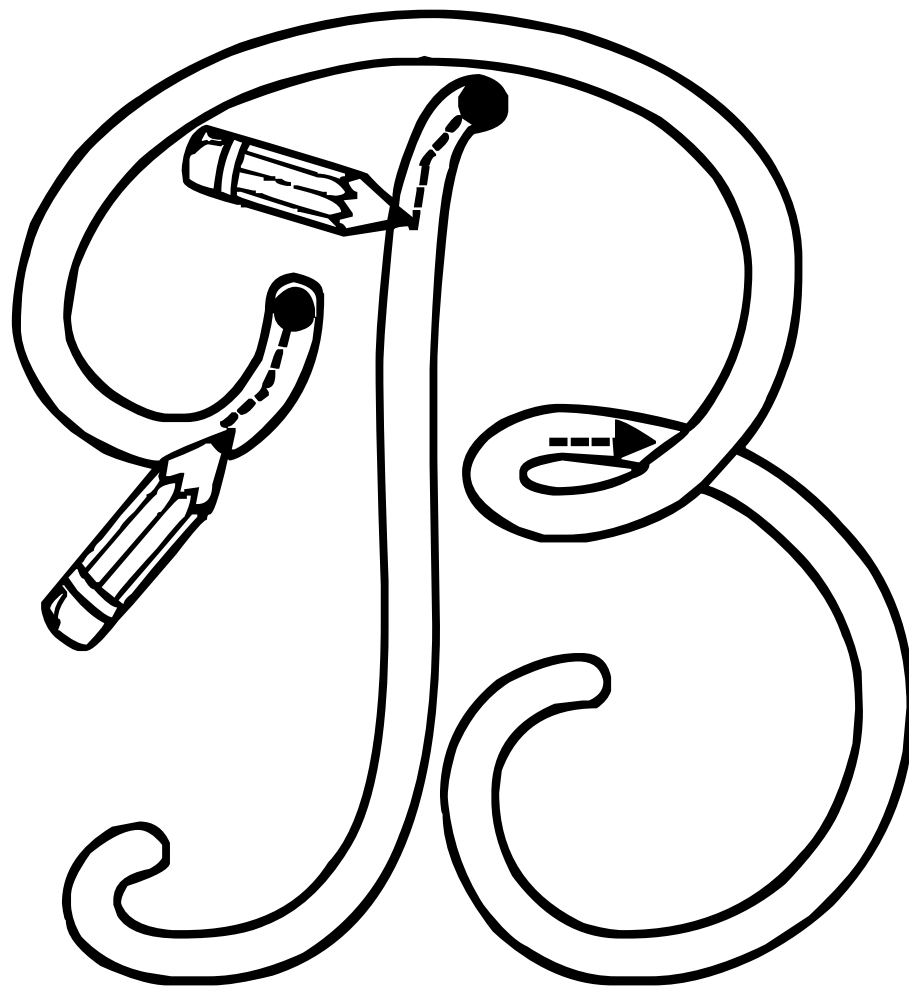

Nom \_\_\_\_\_

Date \_\_\_\_\_

Repasse sur la lettre B / b

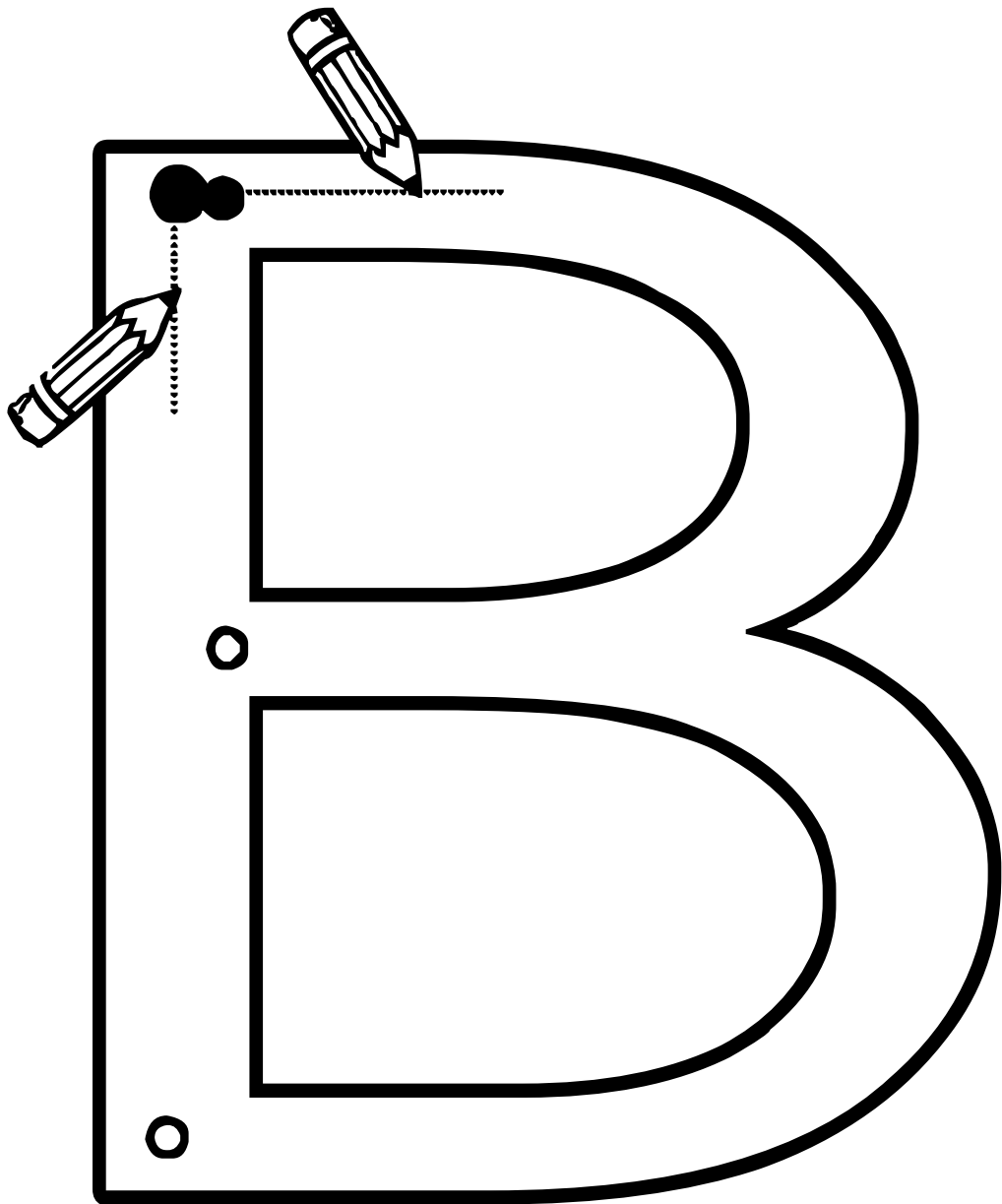

Nom \_\_\_\_\_

Date \_\_\_\_\_

## Ecris la lettre B / b

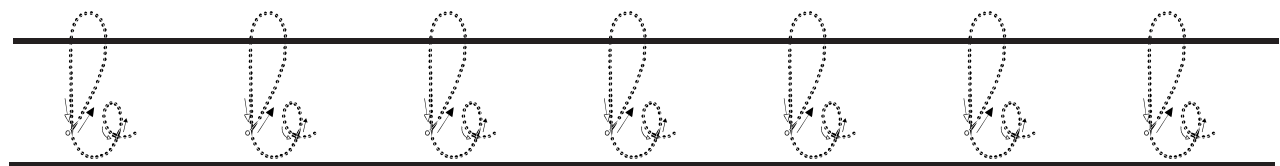
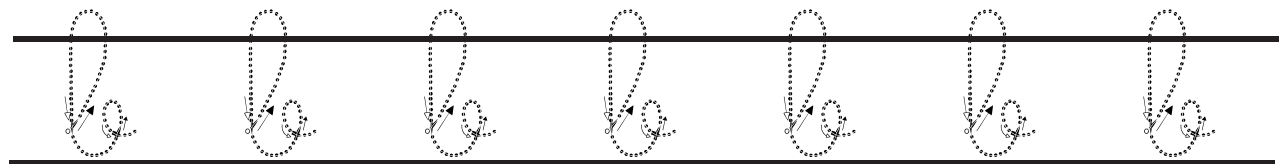
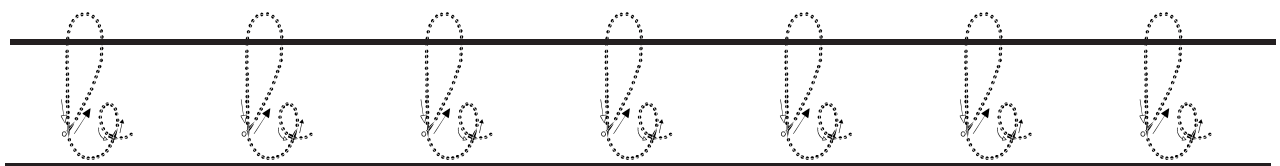
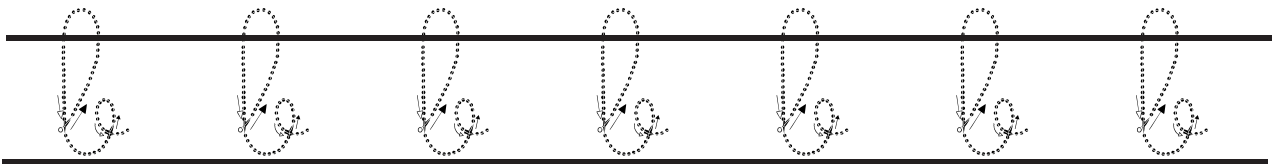
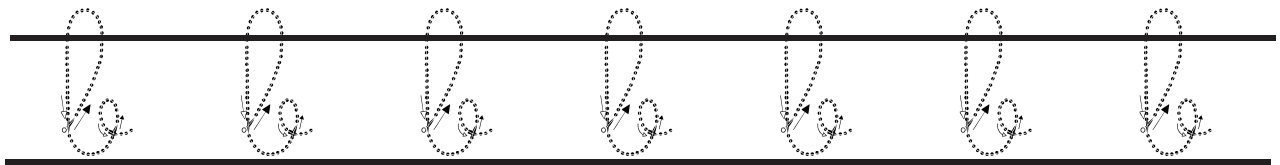
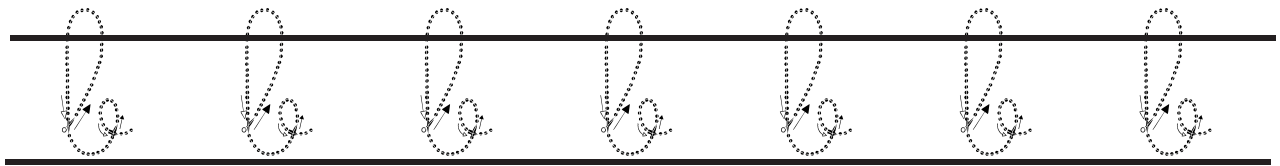
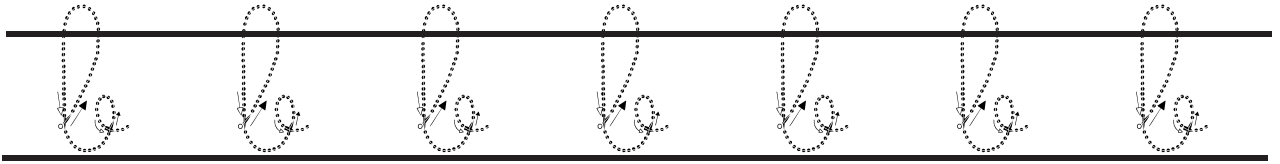

Nom \_\_\_\_\_

Date \_\_\_\_\_

# Ecris la lettre B / b

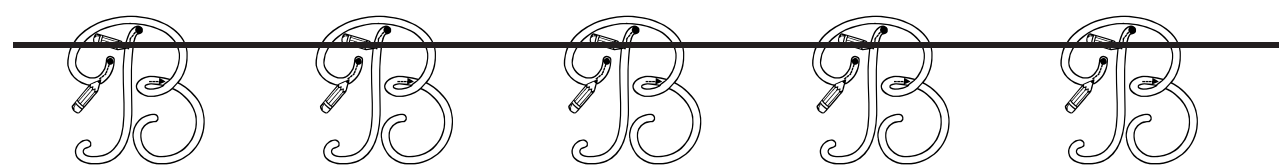
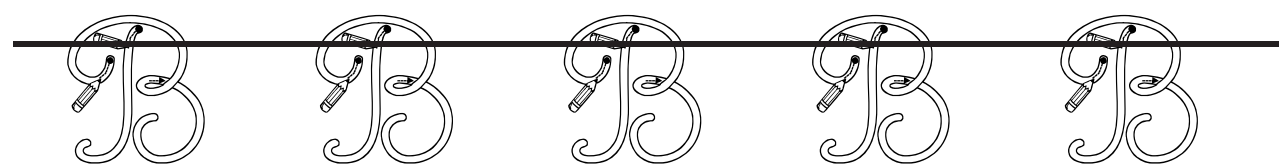
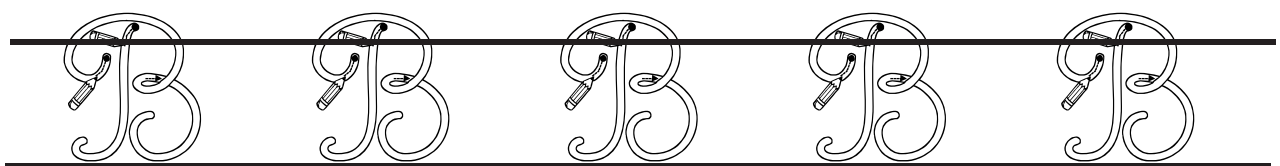
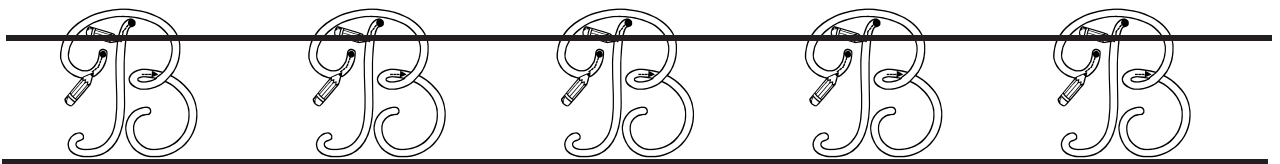
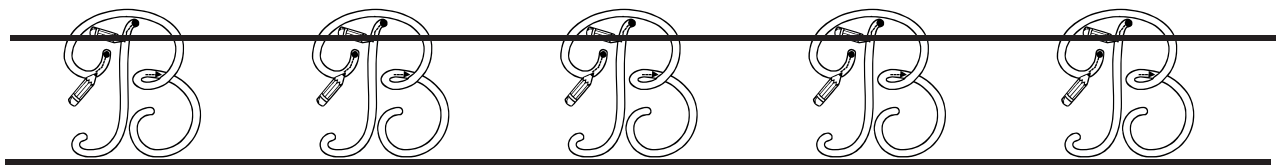
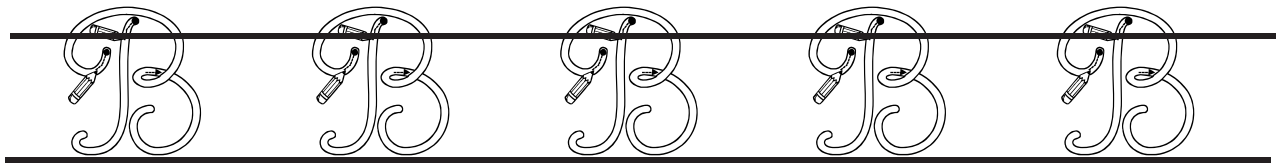
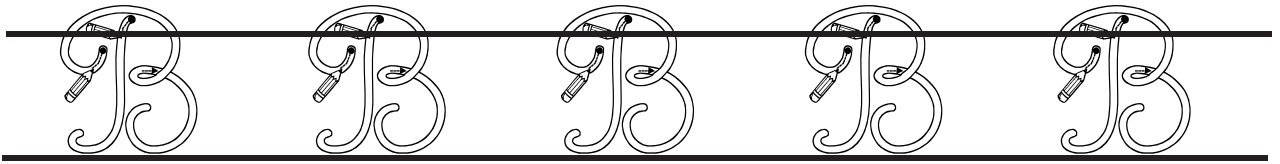

Nom \_\_\_\_\_ Date \_\_\_\_\_

## Ecris la lettre B/b

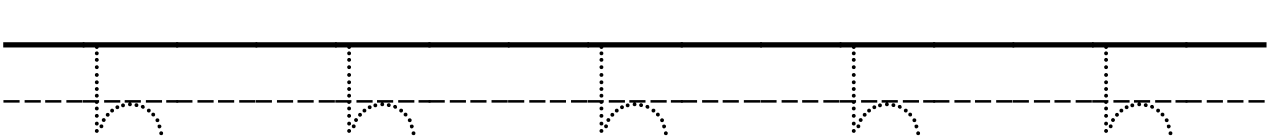
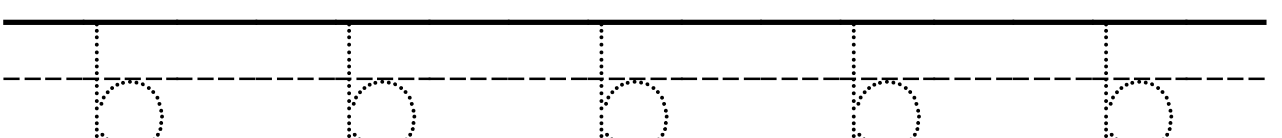
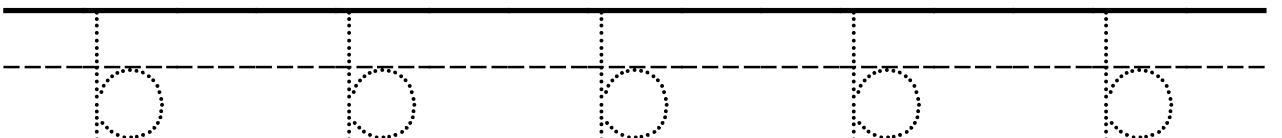
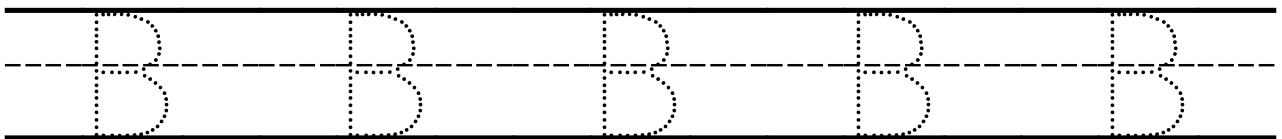
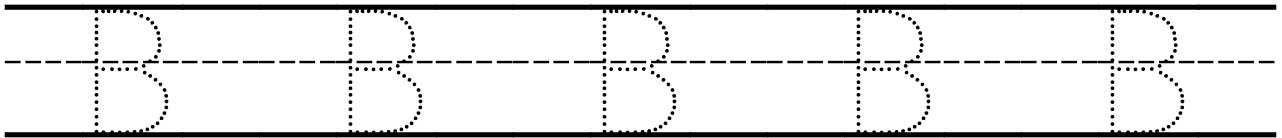
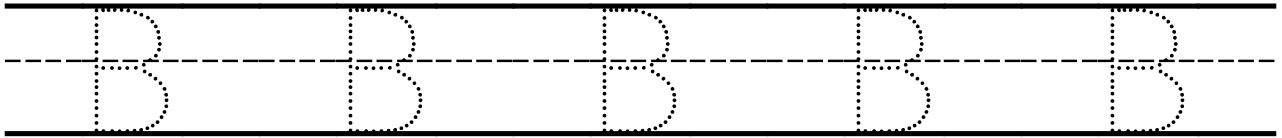
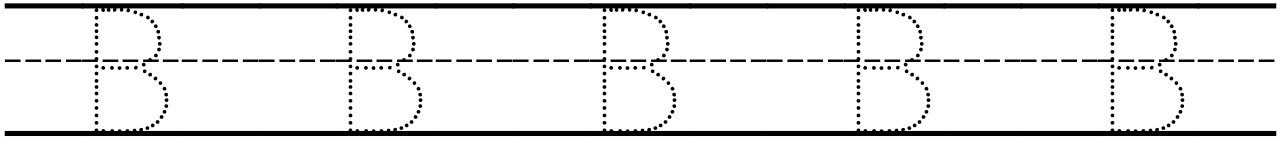

Nom \_\_\_\_\_ Date \_\_\_\_\_

Ecris la lettre B/b

B B B B B

Handwriting practice lines for uppercase letter B, consisting of two sets of four horizontal lines (top solid, middle dashed, bottom solid, bottom solid).

b b b b b

Handwriting practice lines for lowercase letter b, consisting of two sets of four horizontal lines (top solid, middle dashed, bottom solid, bottom solid).

Nom \_\_\_\_\_

Date \_\_\_\_\_

## Colorie la lettre B

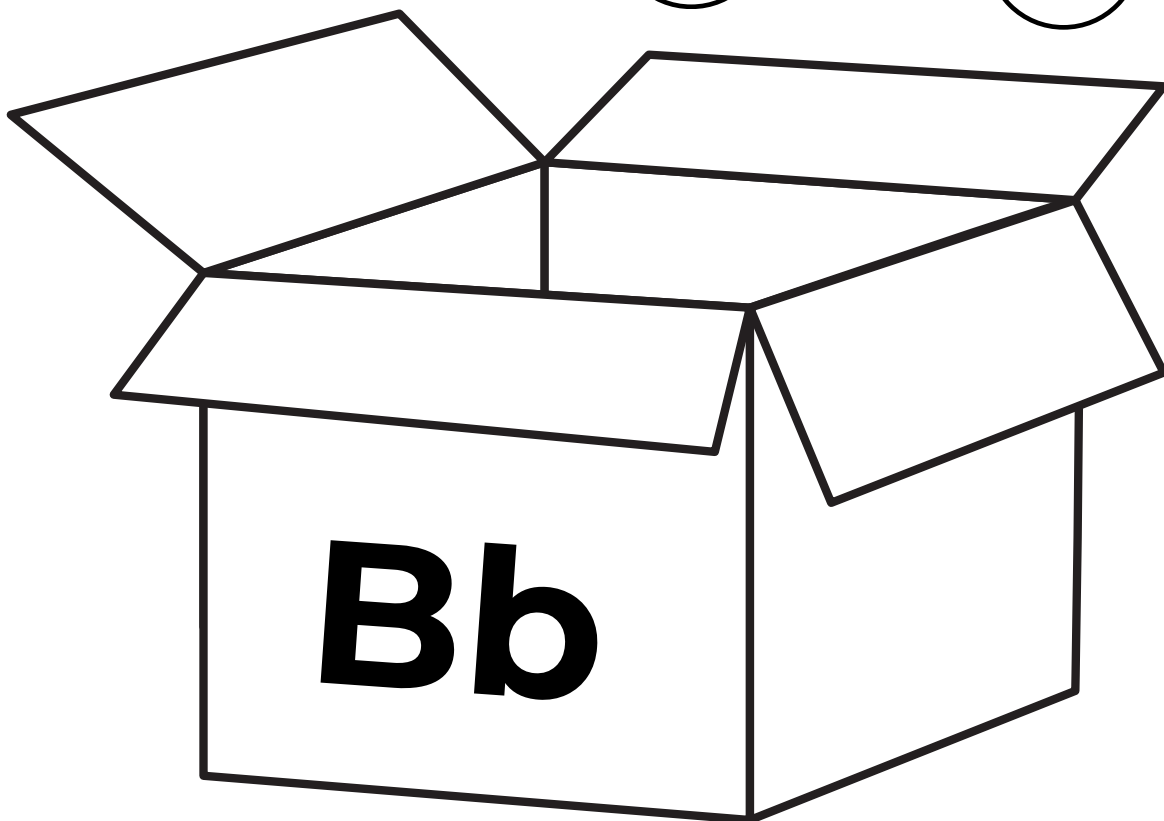
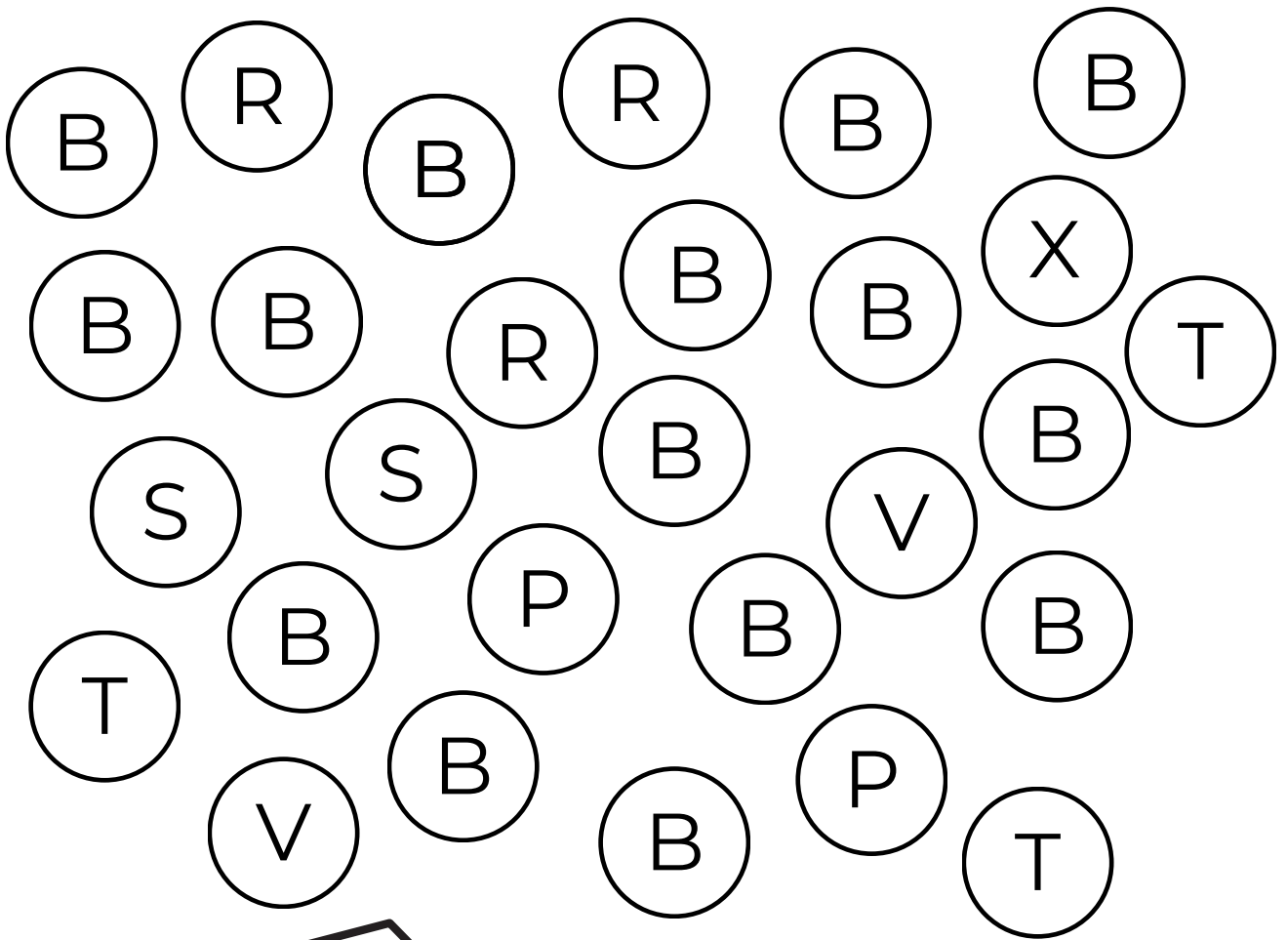

Nom \_\_\_\_\_

Date \_\_\_\_\_

## Colorie la lettre b

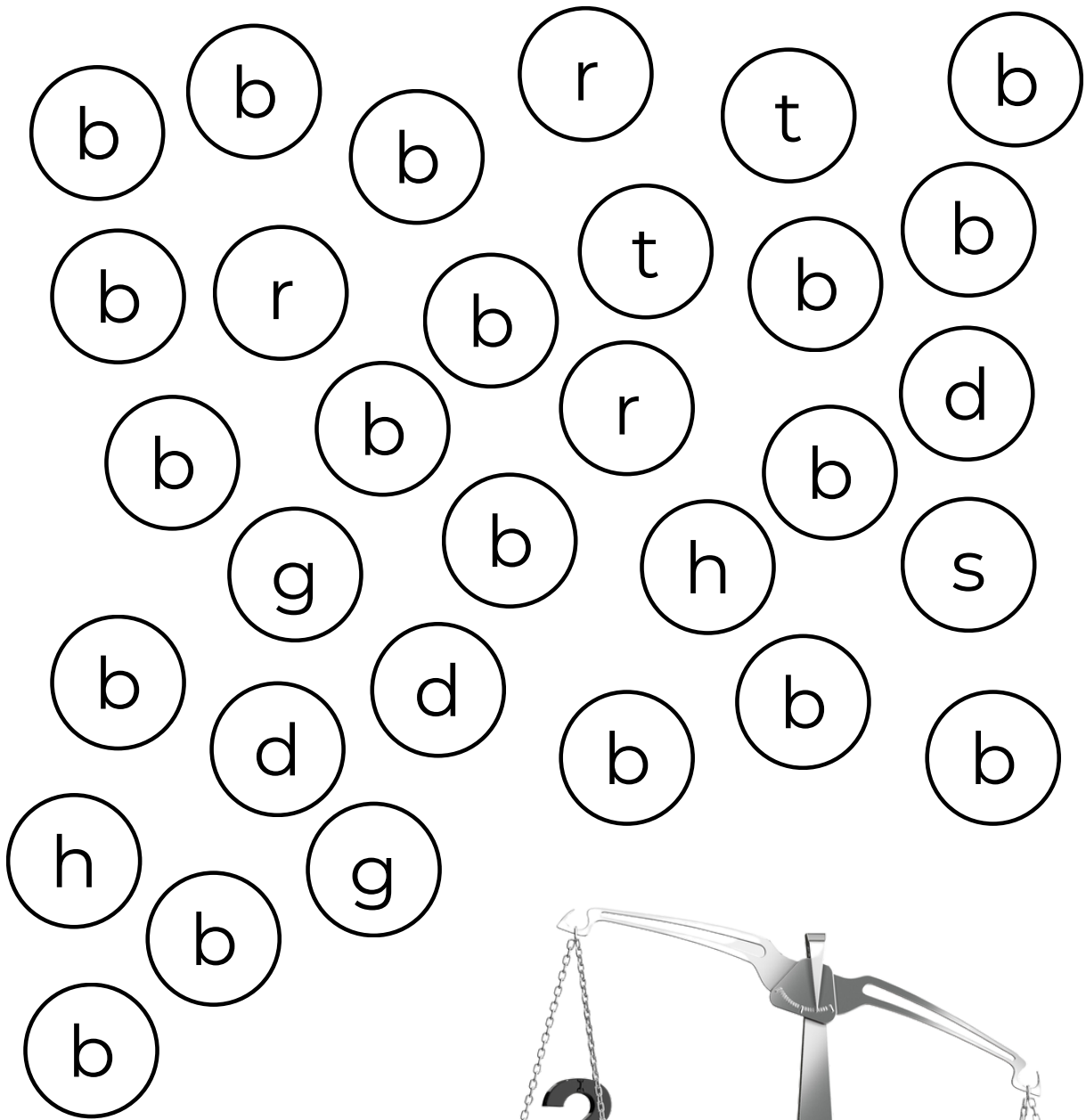

BALANCE / balance

Nom \_\_\_\_\_

Date \_\_\_\_\_

Repasse sur la lettre C / c

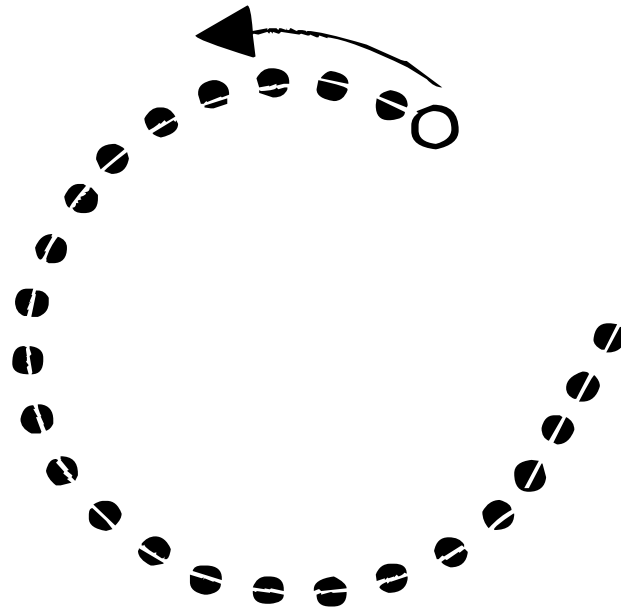

Nom \_\_\_\_\_

Date \_\_\_\_\_

Repasse sur la lettre C / c

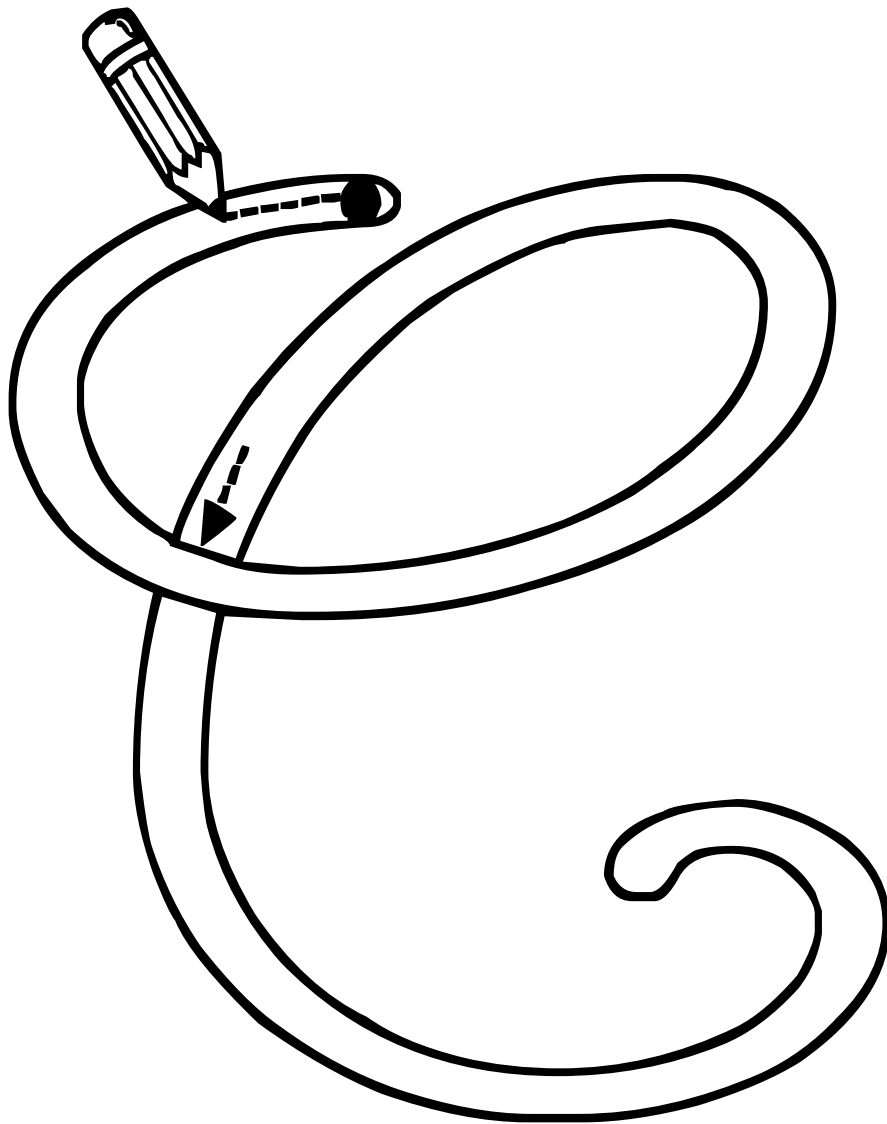

Nom \_\_\_\_\_

Date \_\_\_\_\_

Repasse sur la lettre C / c

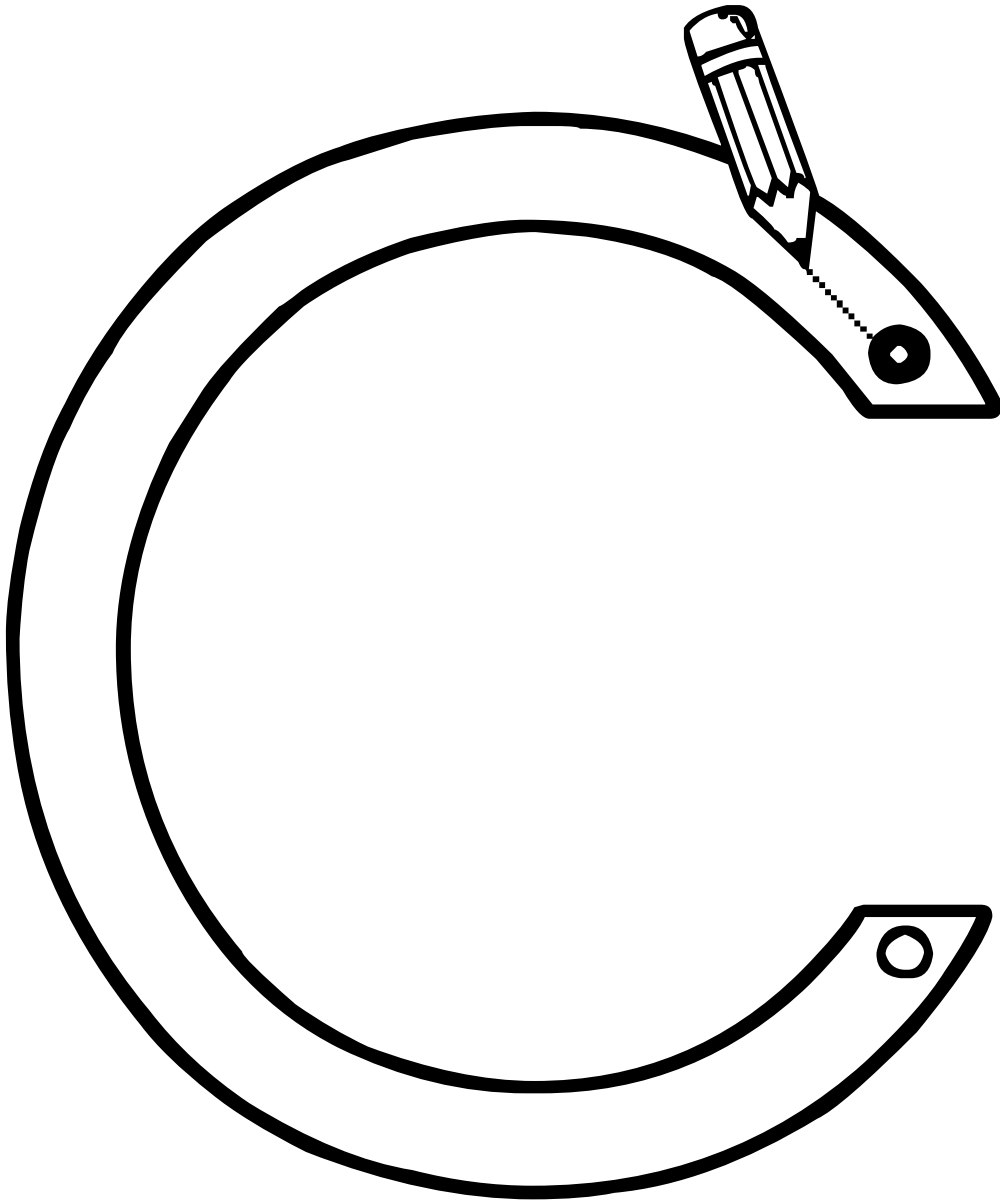

Nom \_\_\_\_\_ Date \_\_\_\_\_

# Ecris la lettre C / c

C C C C C C C

C C C C C C C

C C C C C C C

C C C C C C C

C C C C C C C

C C C C C C C

C C C C C C C

Nom \_\_\_\_\_

Date \_\_\_\_\_

# Ecris la lettre C / c

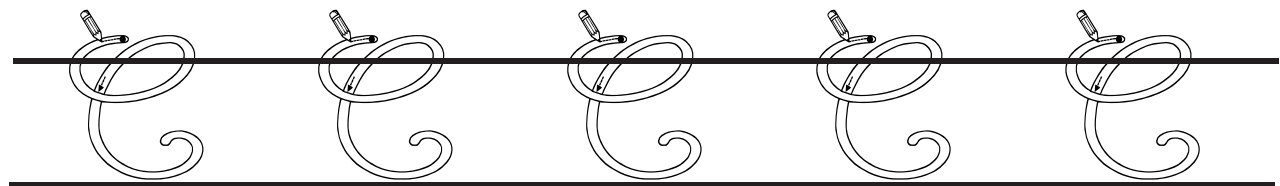
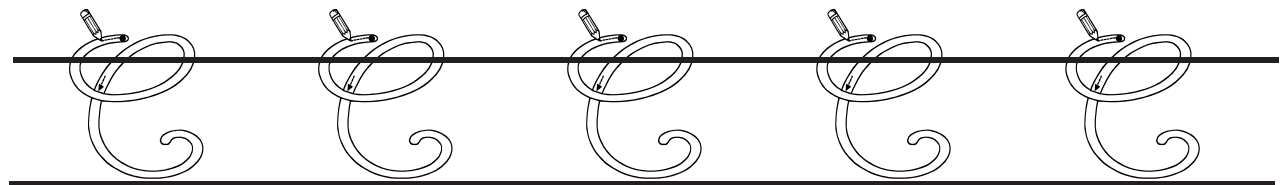
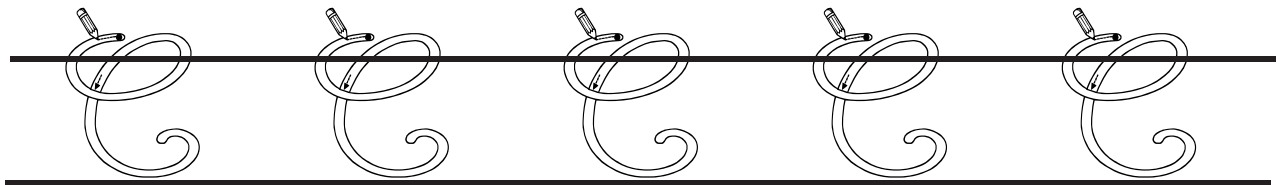
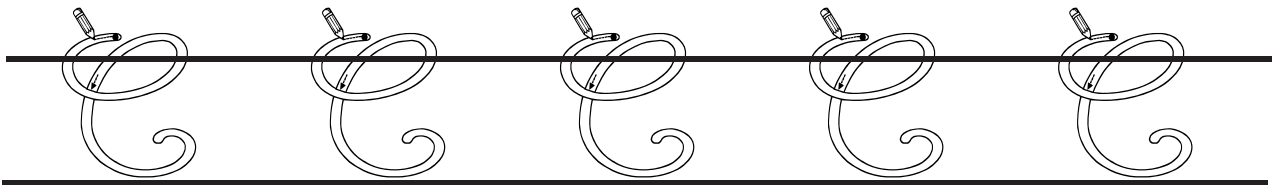
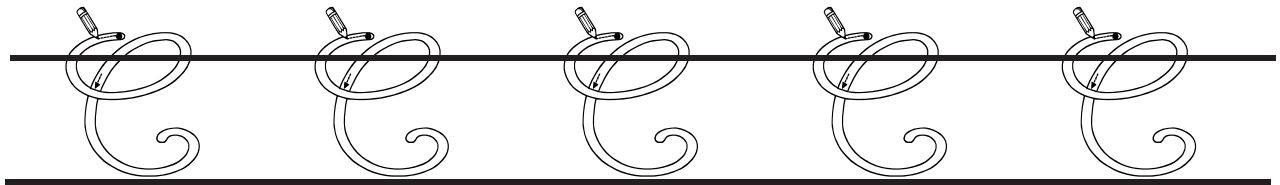
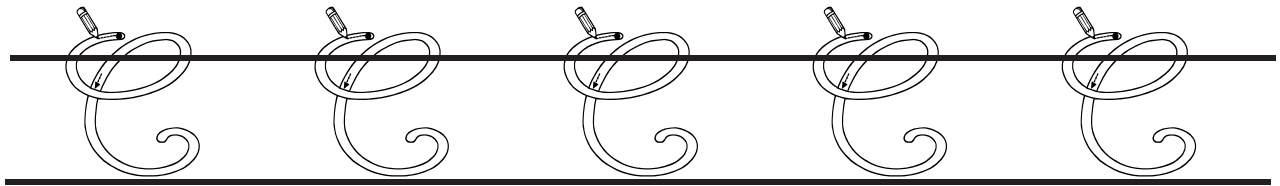
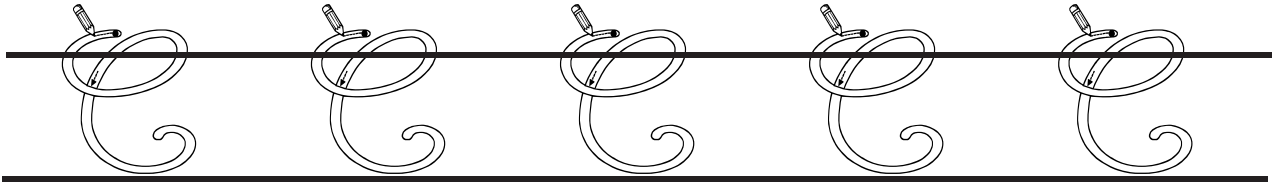

Nom \_\_\_\_\_ Date \_\_\_\_\_

# Ecris la lettre C/c

C C C C C

C C C C C

C C C C C

C C C C C

c c c c c

c c c c c

c c c c c

c c c c c

Nom \_\_\_\_\_ Date \_\_\_\_\_

Ecris la lettre C/c

C C C C C

Handwriting practice lines for uppercase 'C'. Each row consists of a solid top line, a dashed middle line, and a solid bottom line. There are two such rows provided for practice.

c c c c c

Handwriting practice lines for lowercase 'c'. Each row consists of a solid top line, a dashed middle line, and a solid bottom line. There are two such rows provided for practice.

Nom \_\_\_\_\_

Date \_\_\_\_\_

## Colorie la lettre C

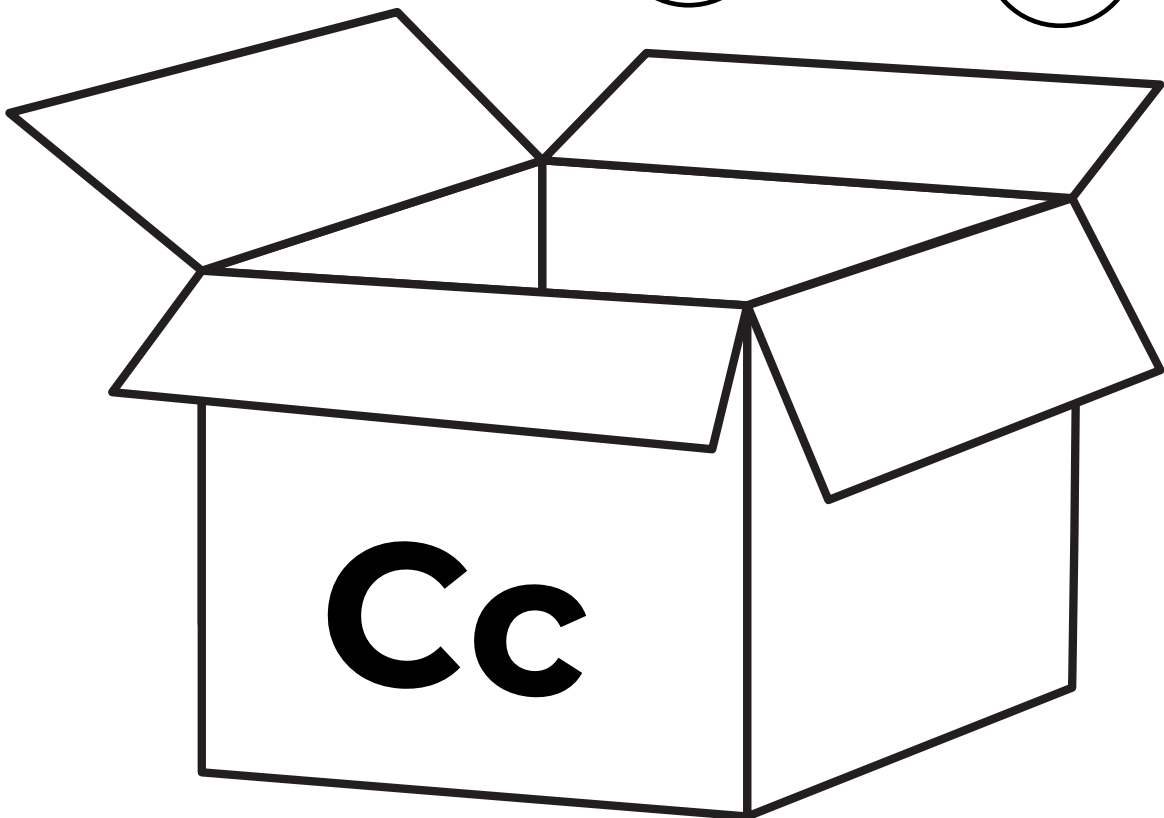
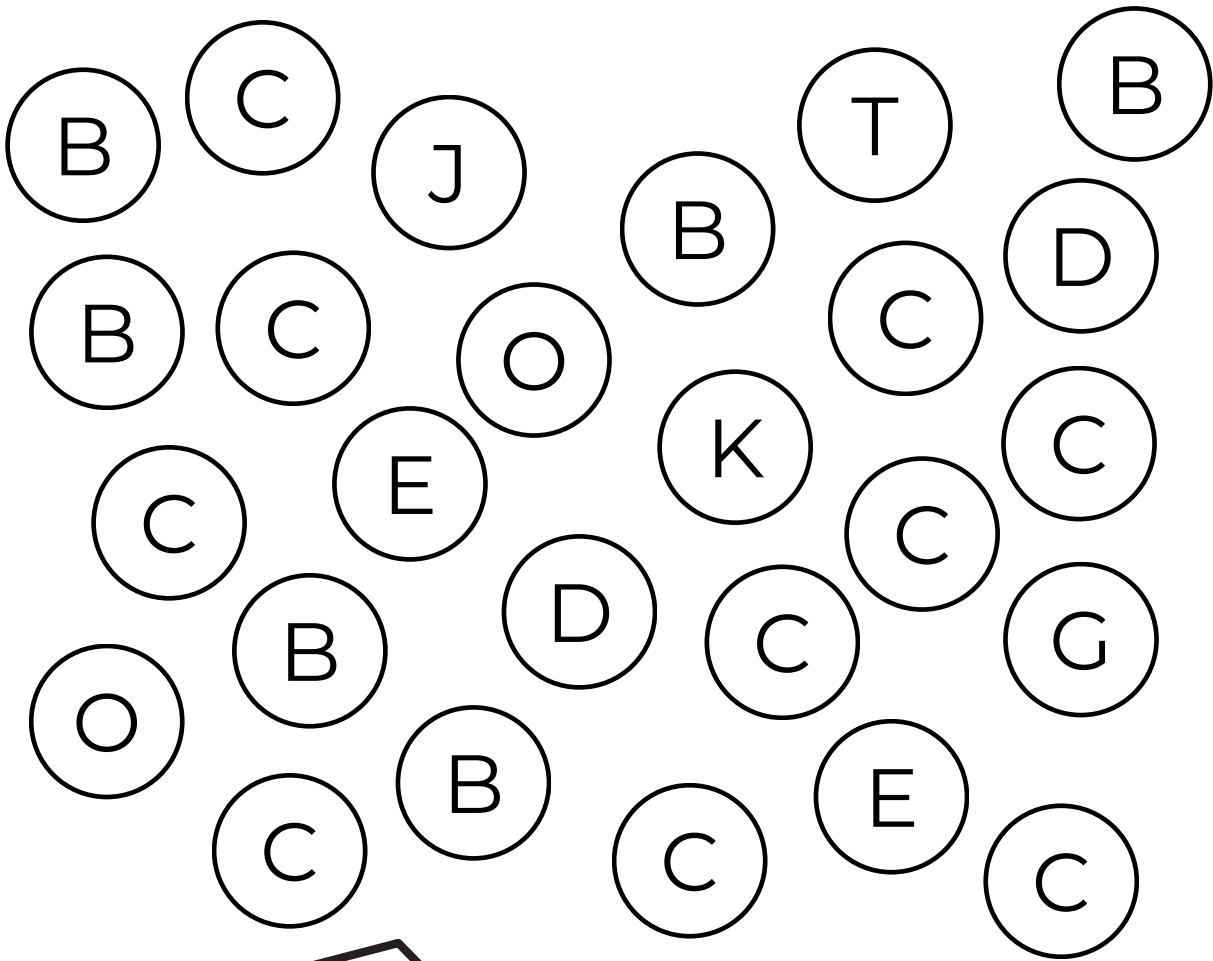

Nom \_\_\_\_\_

Date \_\_\_\_\_

## Colorie la lettre c

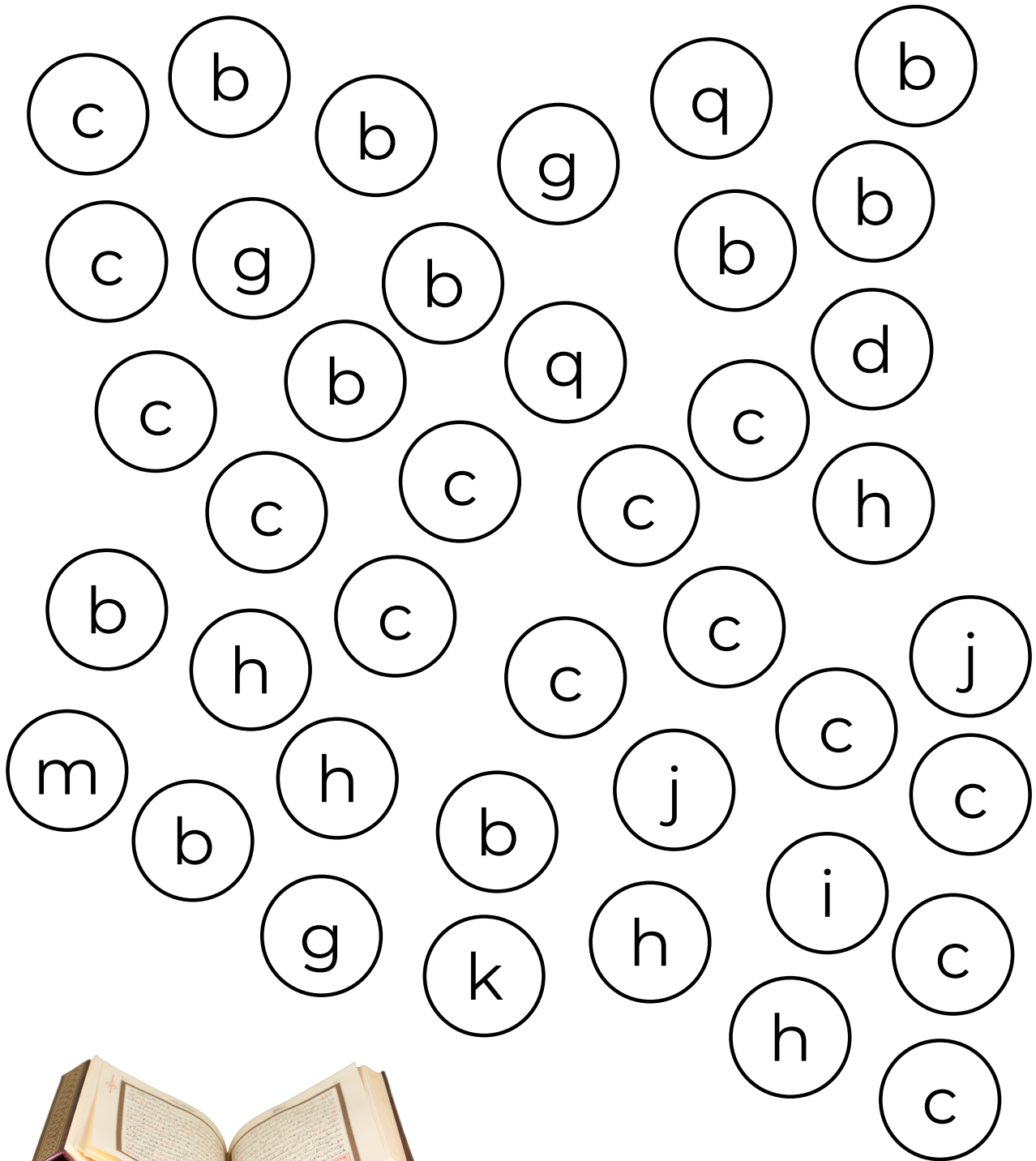

CORAN / coran

Nom \_\_\_\_\_

Date \_\_\_\_\_

Repasse sur la lettre D / d

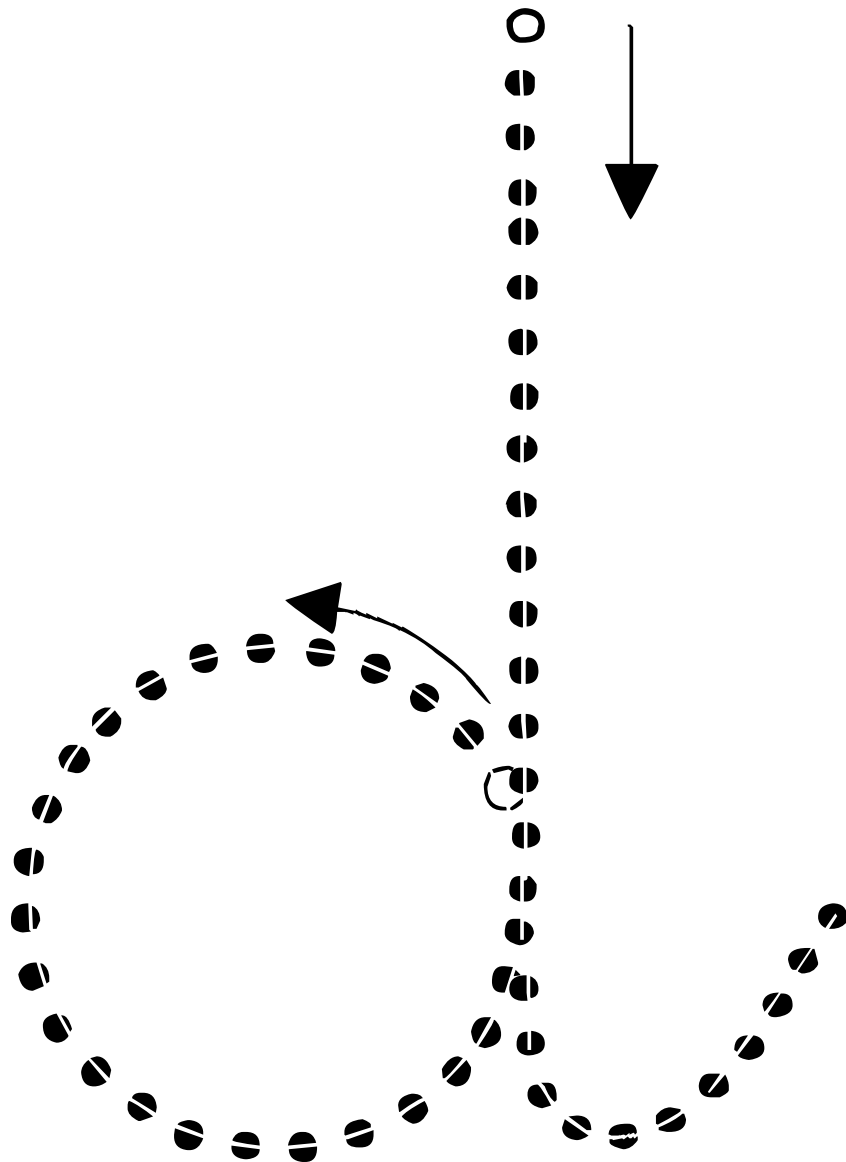

Nom \_\_\_\_\_

Date \_\_\_\_\_

Repasse sur la lettre D / d

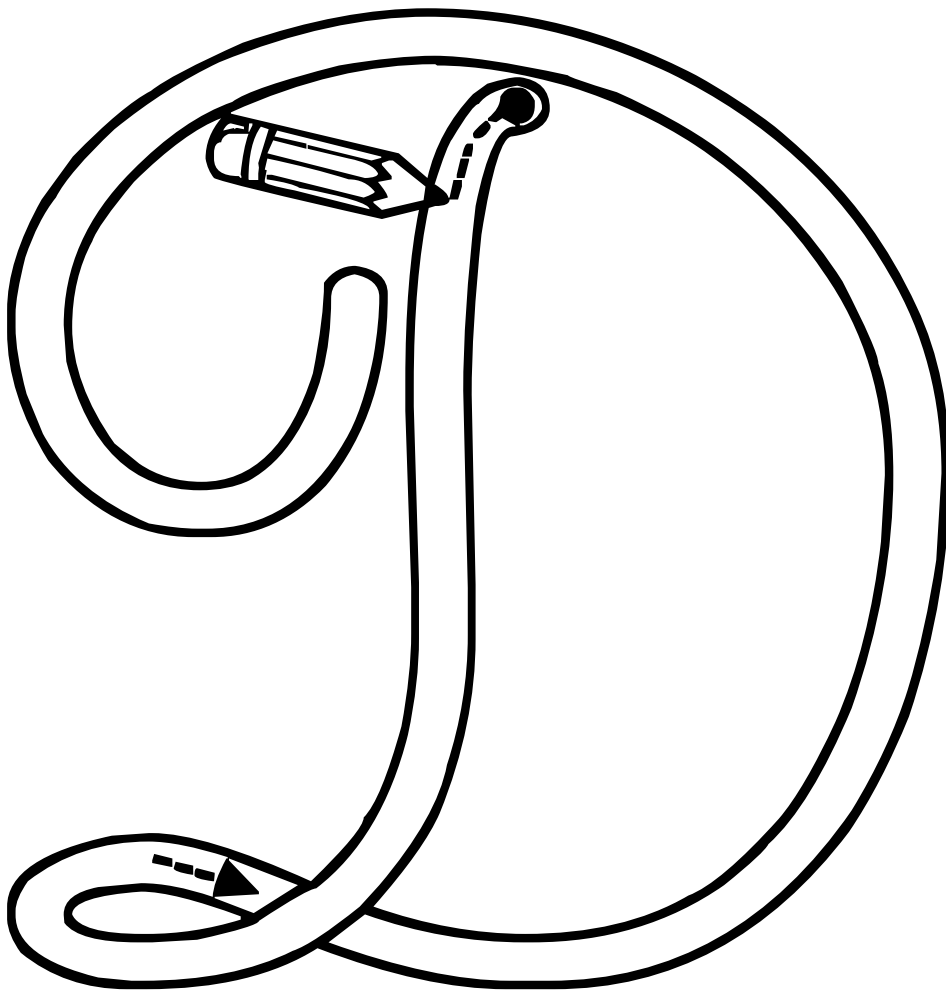

Nom \_\_\_\_\_

Date \_\_\_\_\_

Repasse sur la lettre D / d

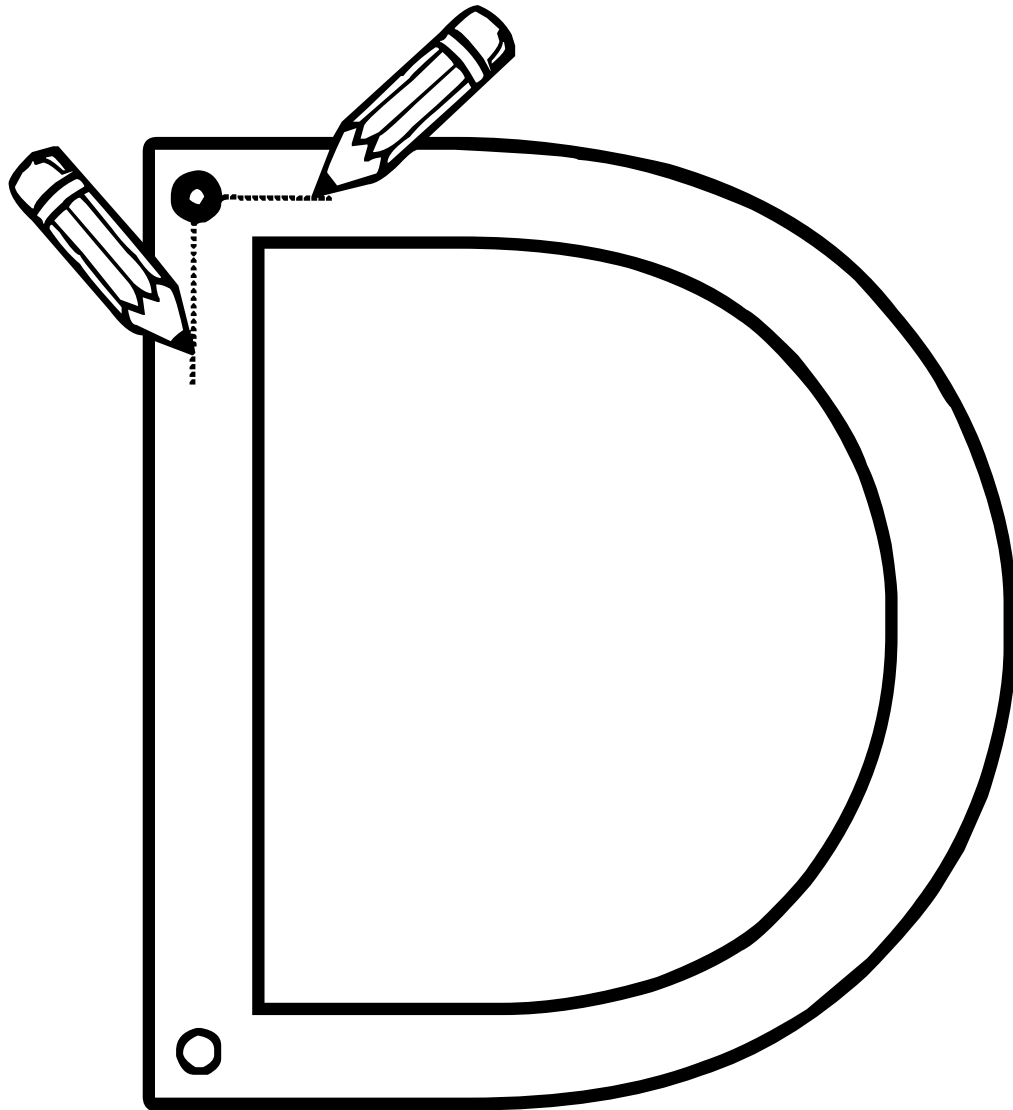

Nom \_\_\_\_\_

Date \_\_\_\_\_

## Ecris la lettre D / d

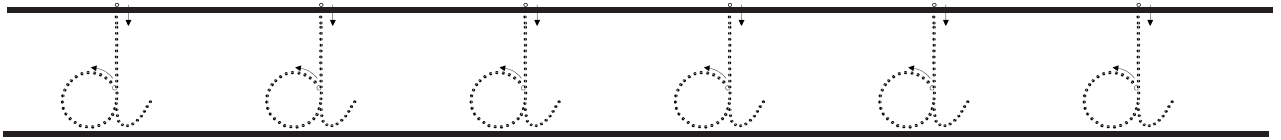

Nom \_\_\_\_\_

Date \_\_\_\_\_

# Ecris la lettre D / d

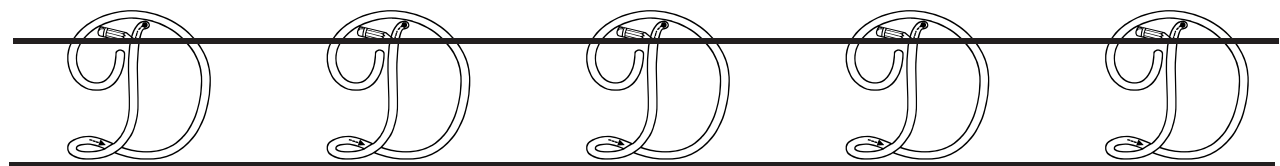
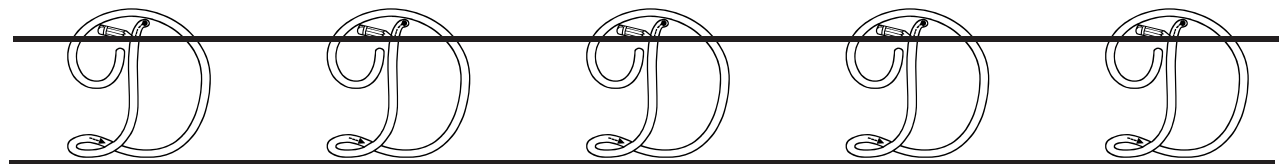
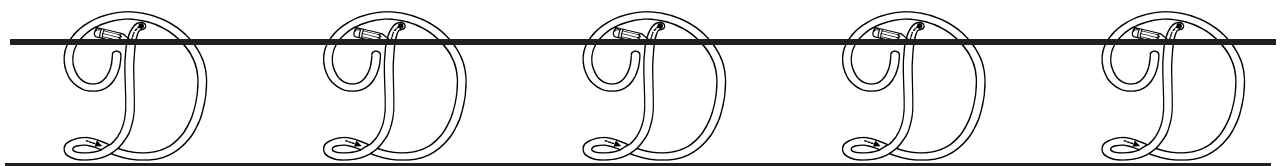
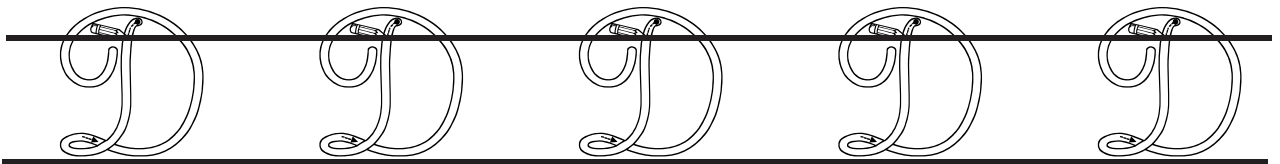
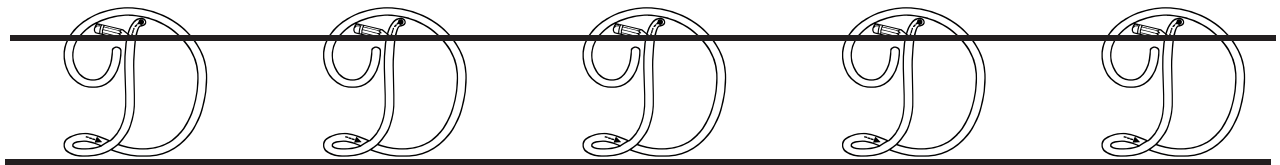
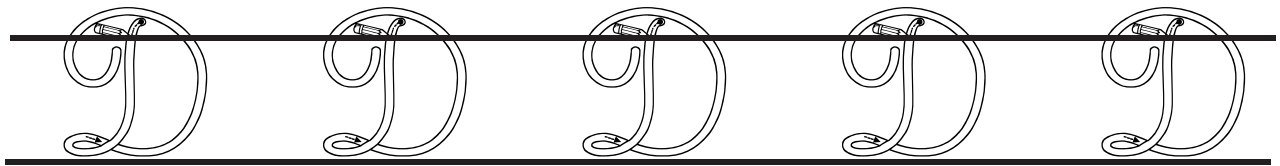
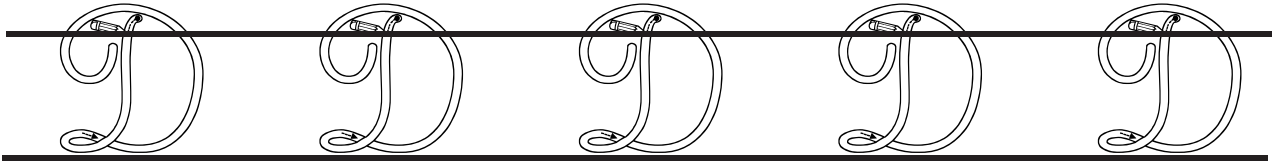

Nom \_\_\_\_\_ Date \_\_\_\_\_

## Ecris la lettre D/d

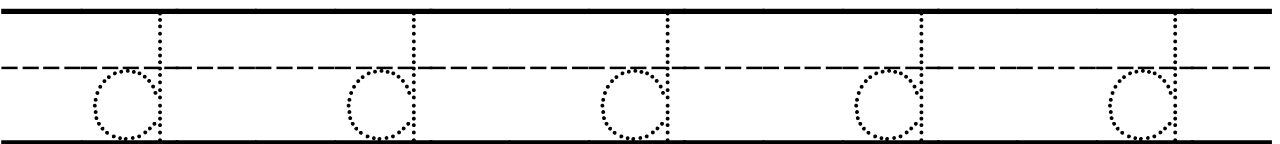
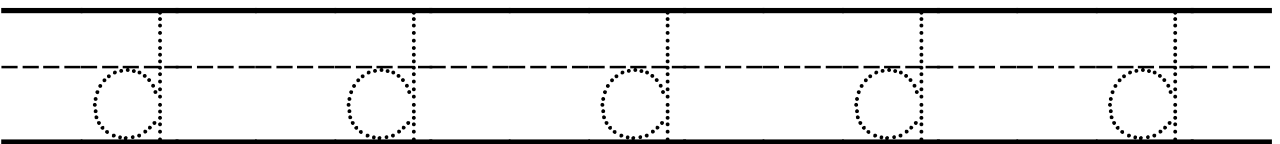
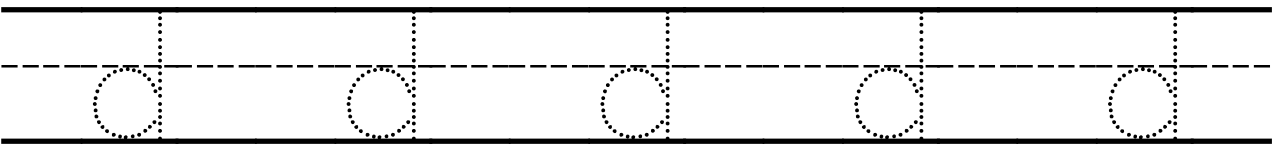
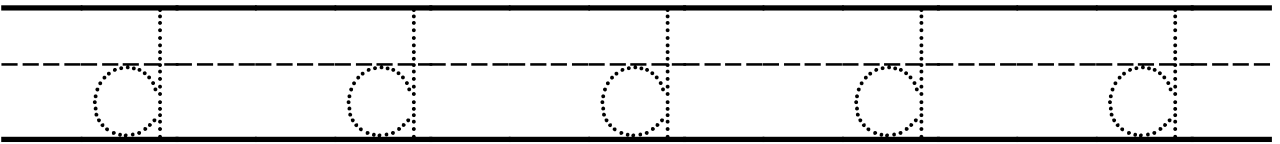
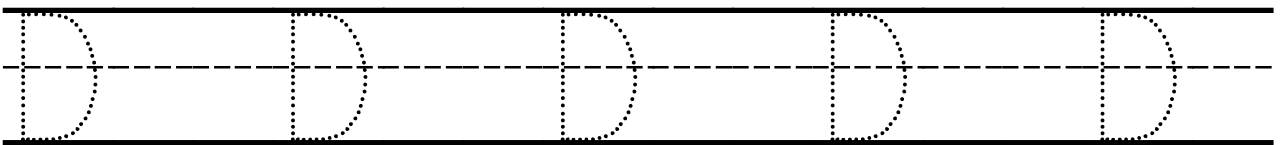
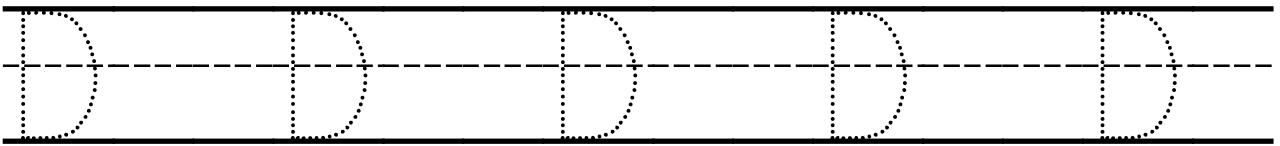
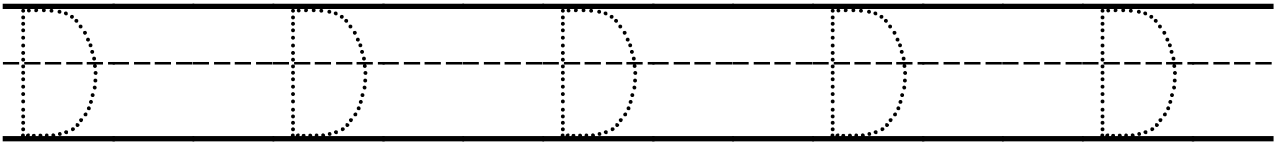
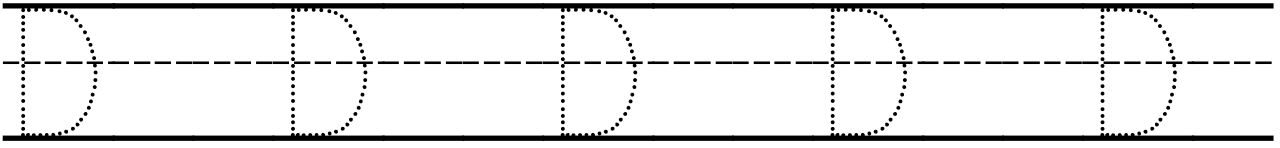

Nom \_\_\_\_\_ Date \_\_\_\_\_

Ecris la lettre D/d

D D D D D

Handwriting practice lines for uppercase letter D. The first set of lines is a solid top line, a dashed middle line, and a solid bottom line. The second set of lines is a solid top line, a dashed middle line, and a solid bottom line.

d d d d d

Handwriting practice lines for lowercase letter d. The first set of lines is a solid top line, a dashed middle line, and a solid bottom line. The second set of lines is a solid top line, a dashed middle line, and a solid bottom line.

Nom \_\_\_\_\_

Date \_\_\_\_\_

Colorie la lettre D

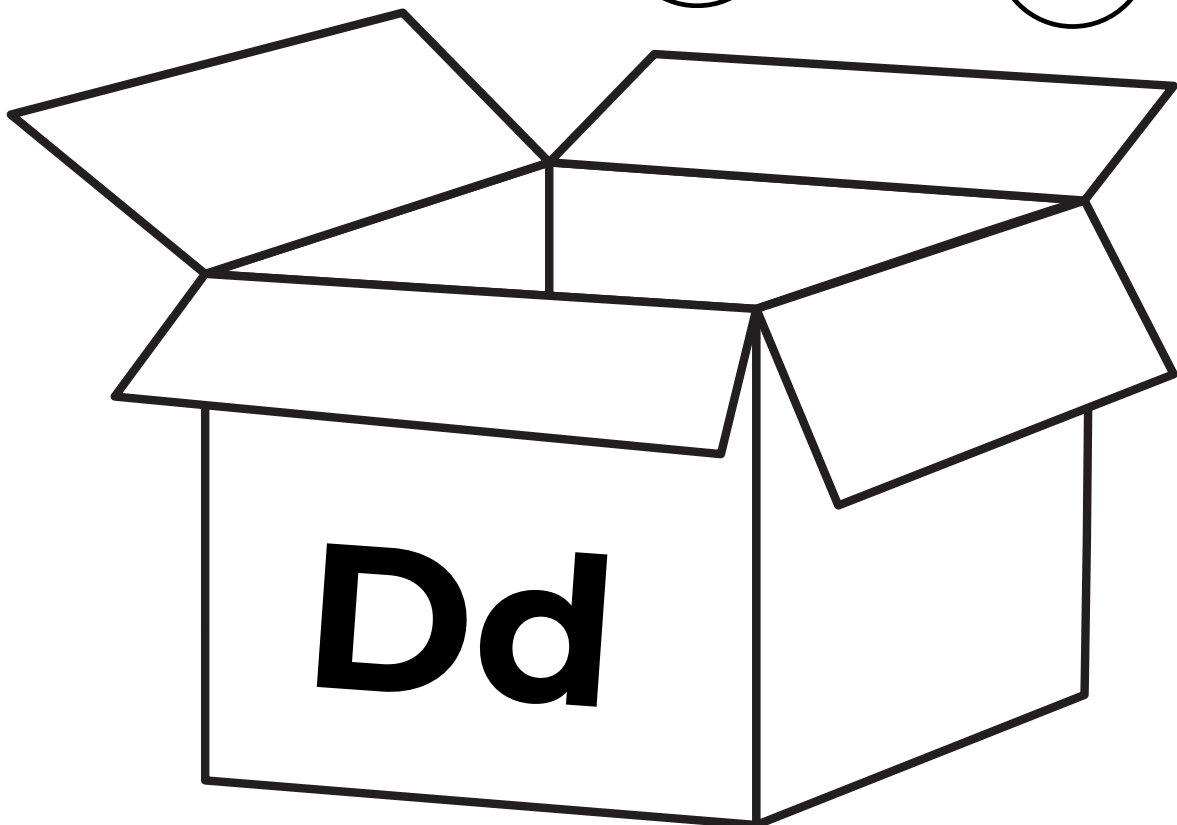
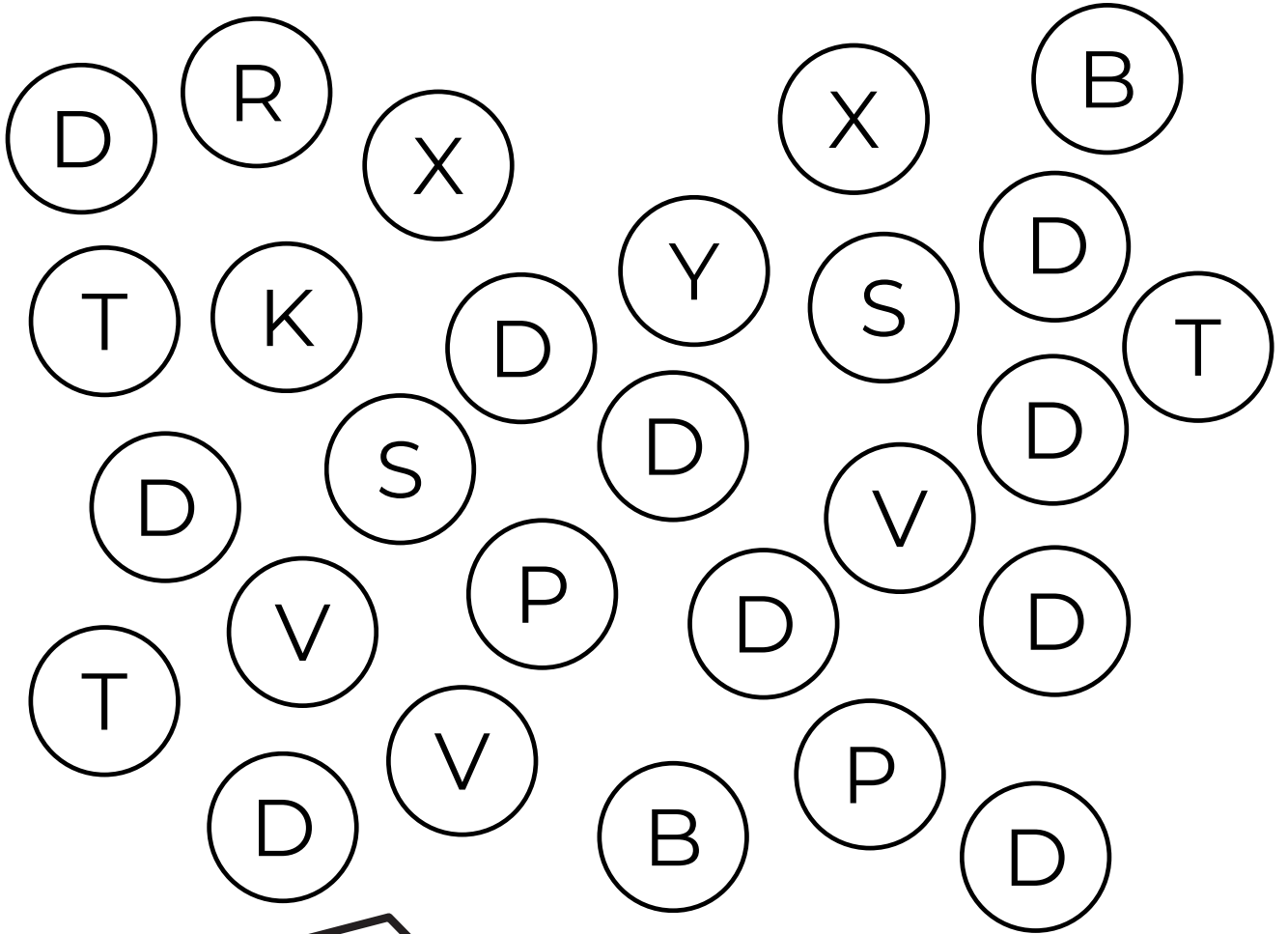

Nom \_\_\_\_\_

Date \_\_\_\_\_

### Colorie la lettre d

A collection of 35 lowercase letters scattered in a grid-like pattern. The letters are: d, d, t, v, d, t, v, t, r, d, g, d, g, b, d, r, d, s, b, d, d, d, v, h, d, g, v, d, b, d, t, s, t.



DATTES / dattes

Nom \_\_\_\_\_

Date \_\_\_\_\_

Repasse sur la lettre E / e

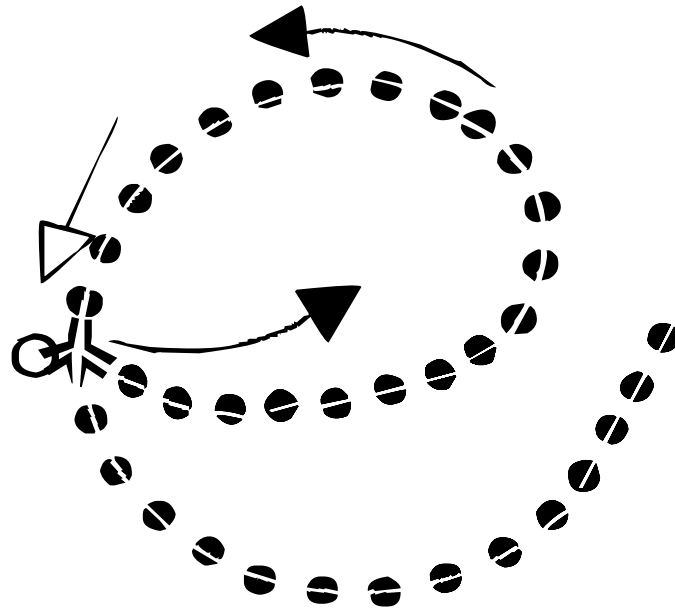

Nom \_\_\_\_\_

Date \_\_\_\_\_

Repasse sur la lettre E / e

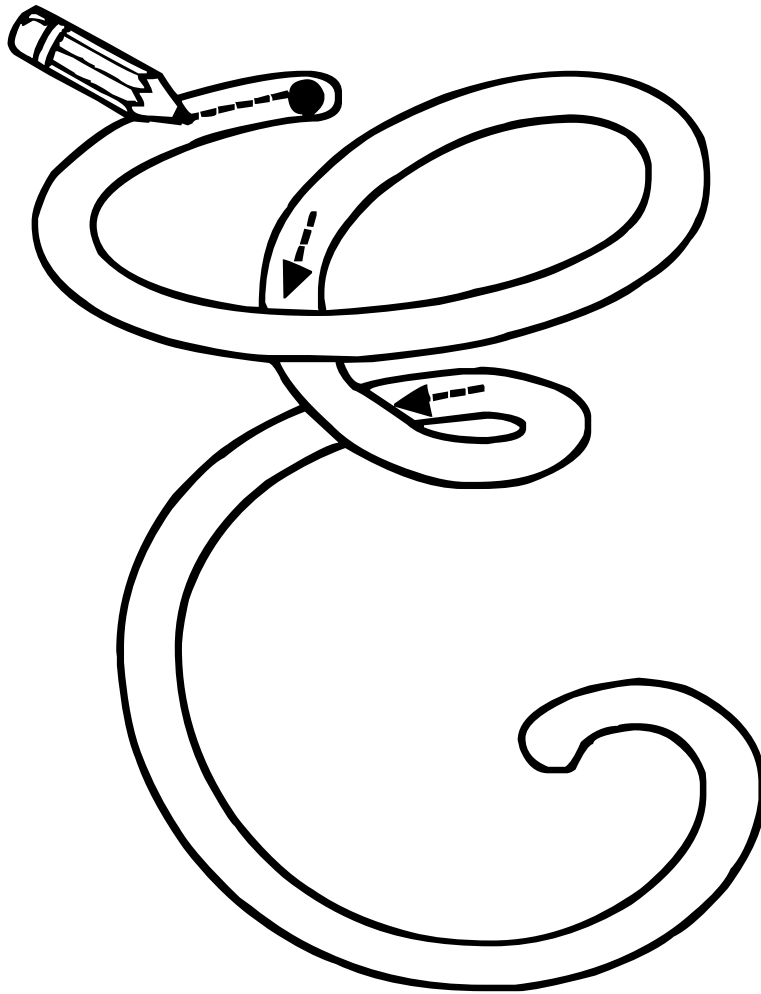

Nom \_\_\_\_\_

Date \_\_\_\_\_

Repasse sur la lettre E / e

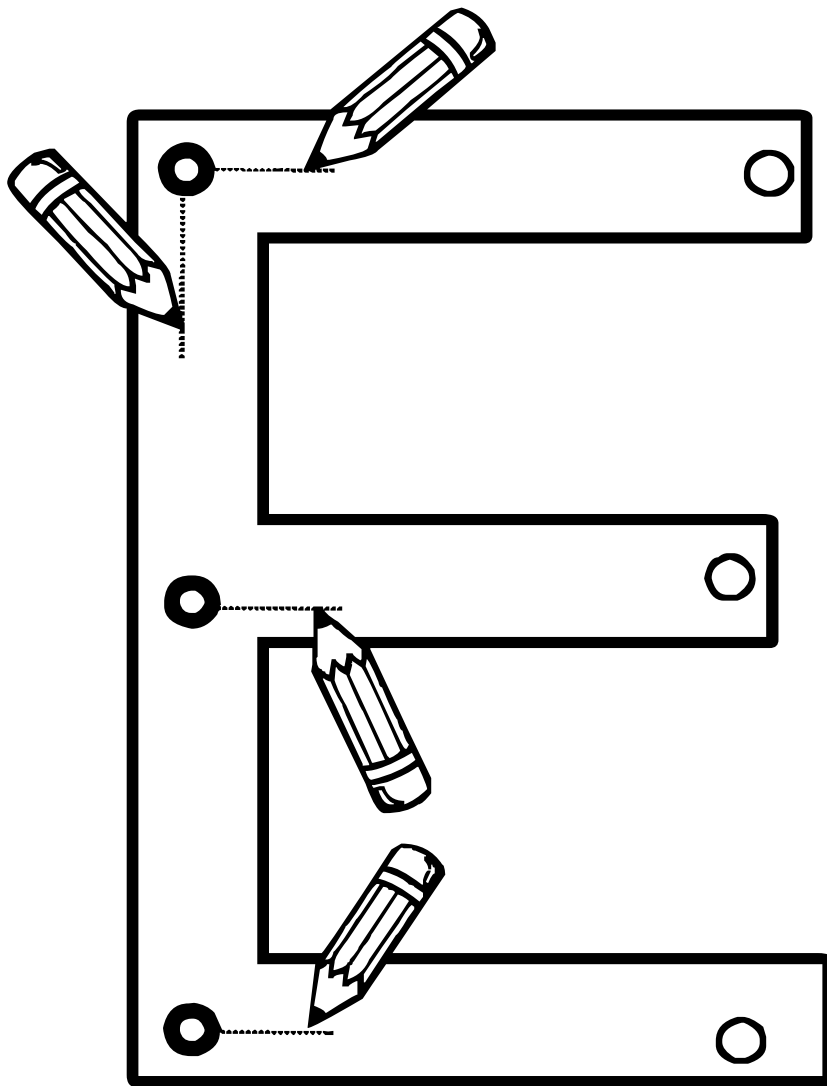

Nom \_\_\_\_\_

Date \_\_\_\_\_

# Ecris la lettre E / e

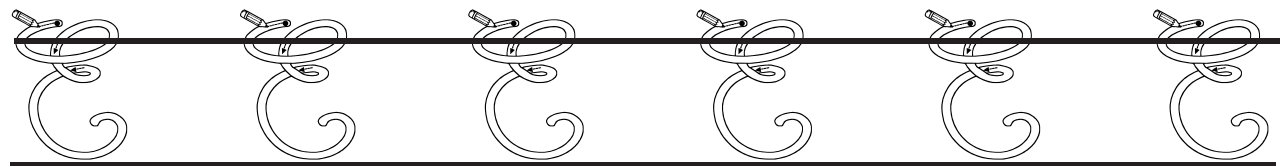
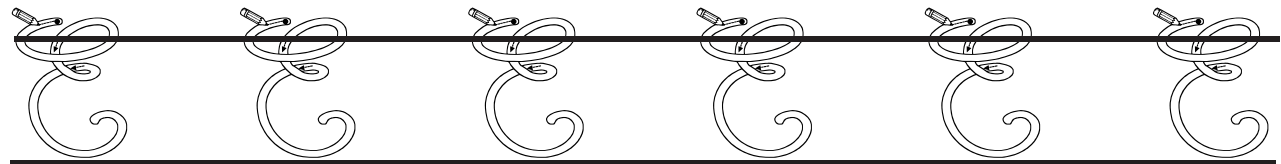
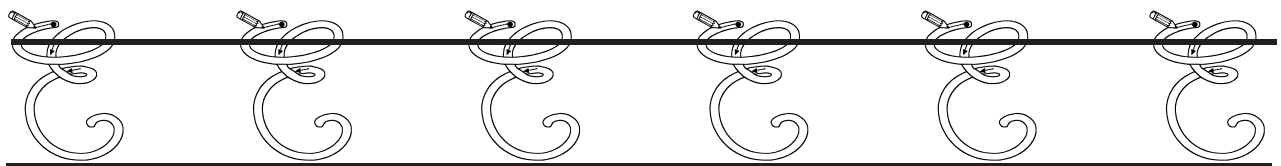
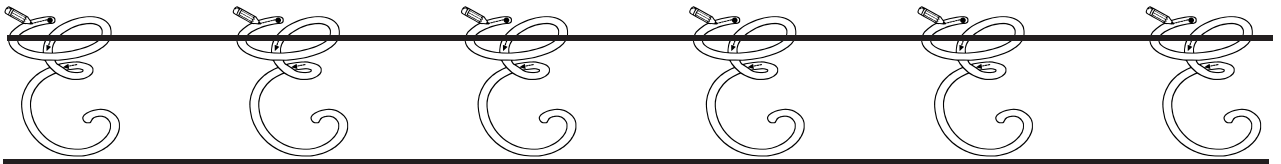
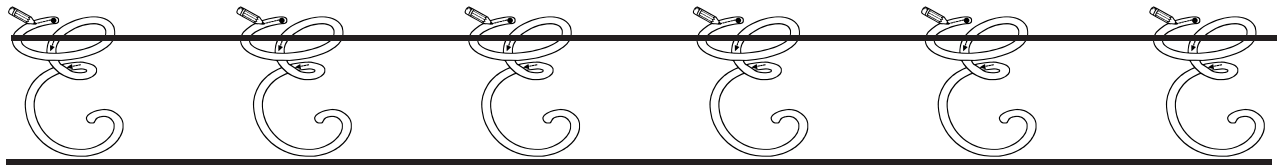
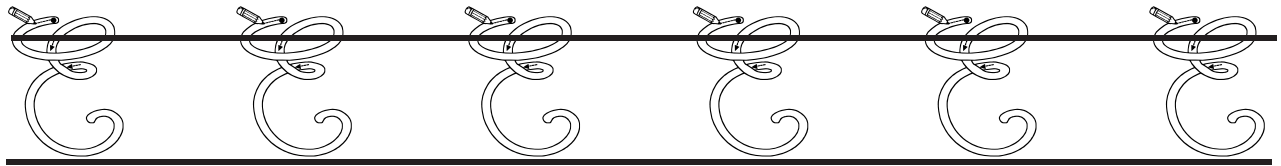
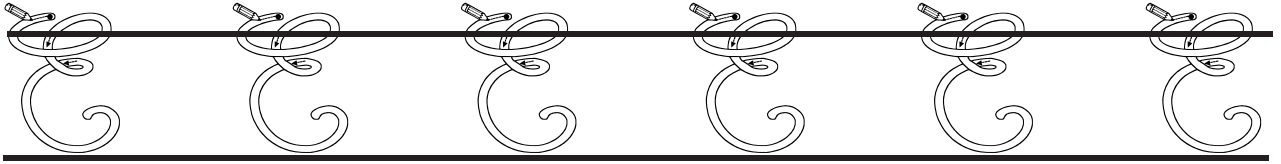

Nom \_\_\_\_\_ Date \_\_\_\_\_

# Ecris la lettre E / e



Nom \_\_\_\_\_

Date \_\_\_\_\_

## Ecris la lettre E/e

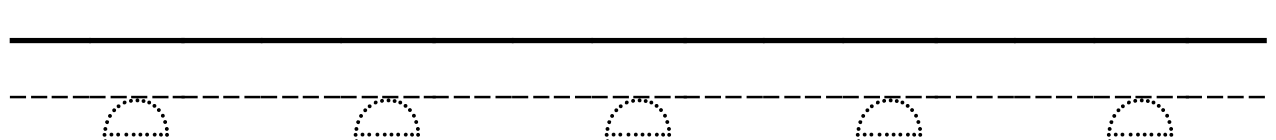
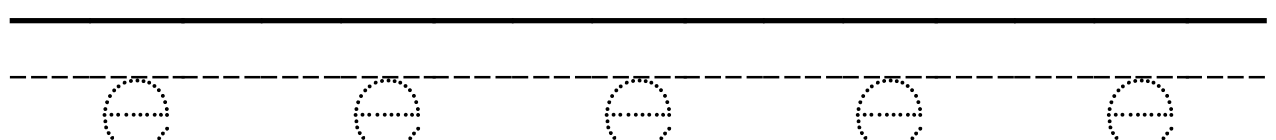
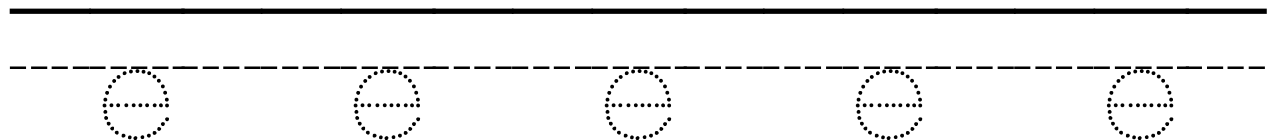
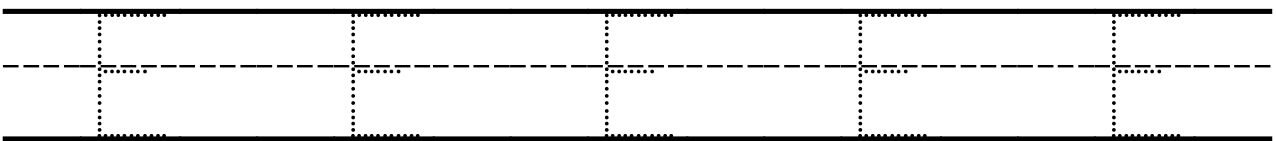
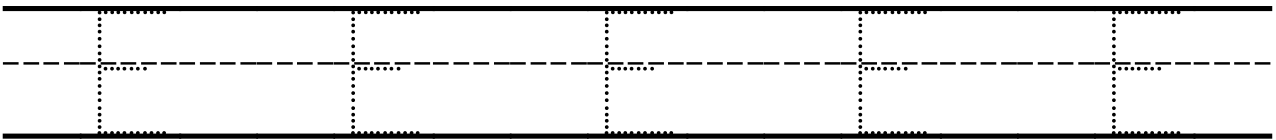
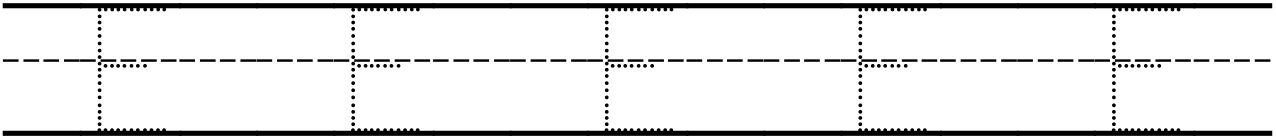
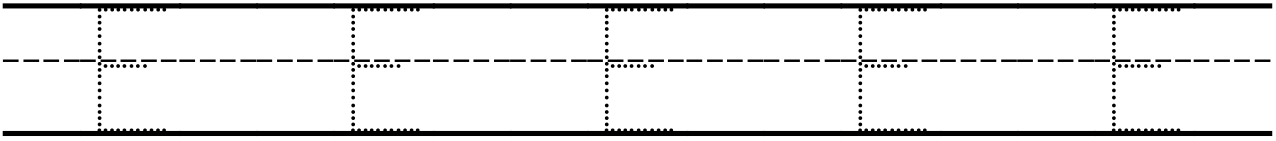

Nom \_\_\_\_\_ Date \_\_\_\_\_

Ecris la lettre E/e

E E E E E

Handwriting practice lines for uppercase 'E'. Each set consists of a solid top line, a dashed middle line, and a solid bottom line. There are two such sets provided for practice.

e e e e e

Handwriting practice lines for lowercase 'e'. Each set consists of a solid top line, a dashed middle line, and a solid bottom line. There are two such sets provided for practice.

Nom \_\_\_\_\_

Date \_\_\_\_\_

## Colorie la lettre E

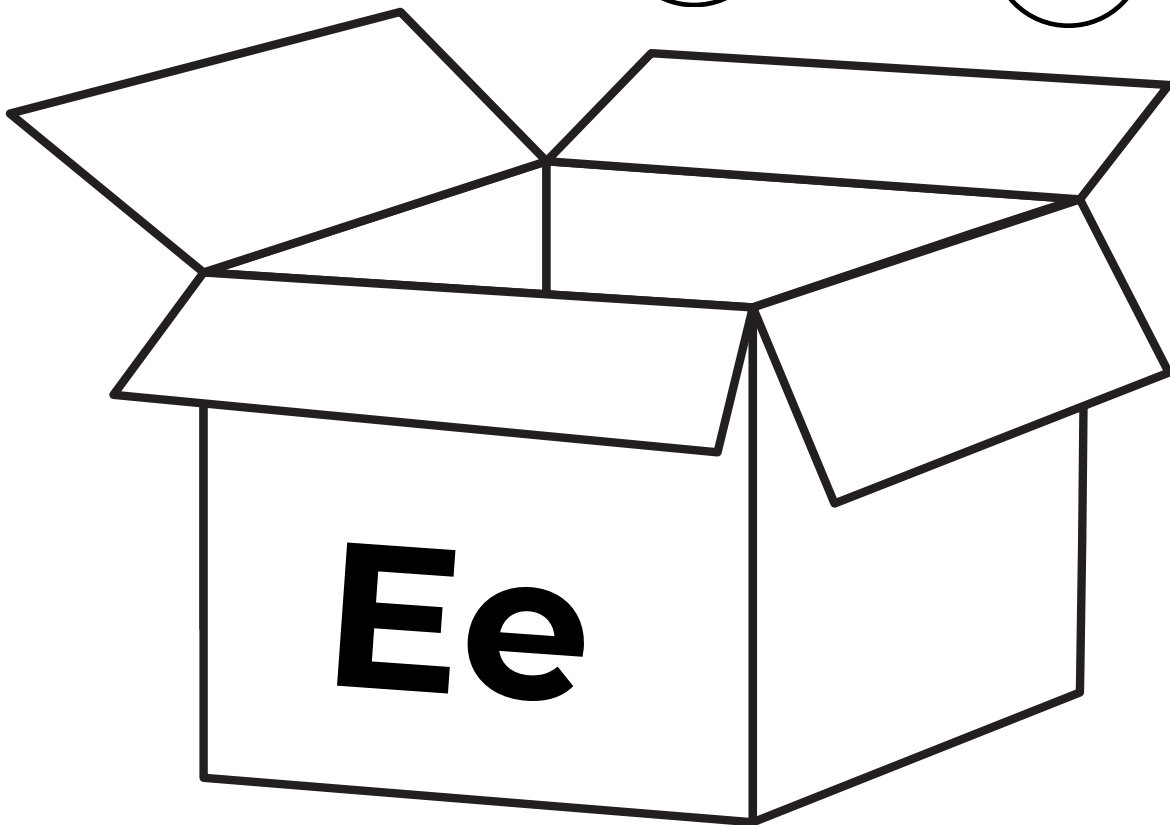
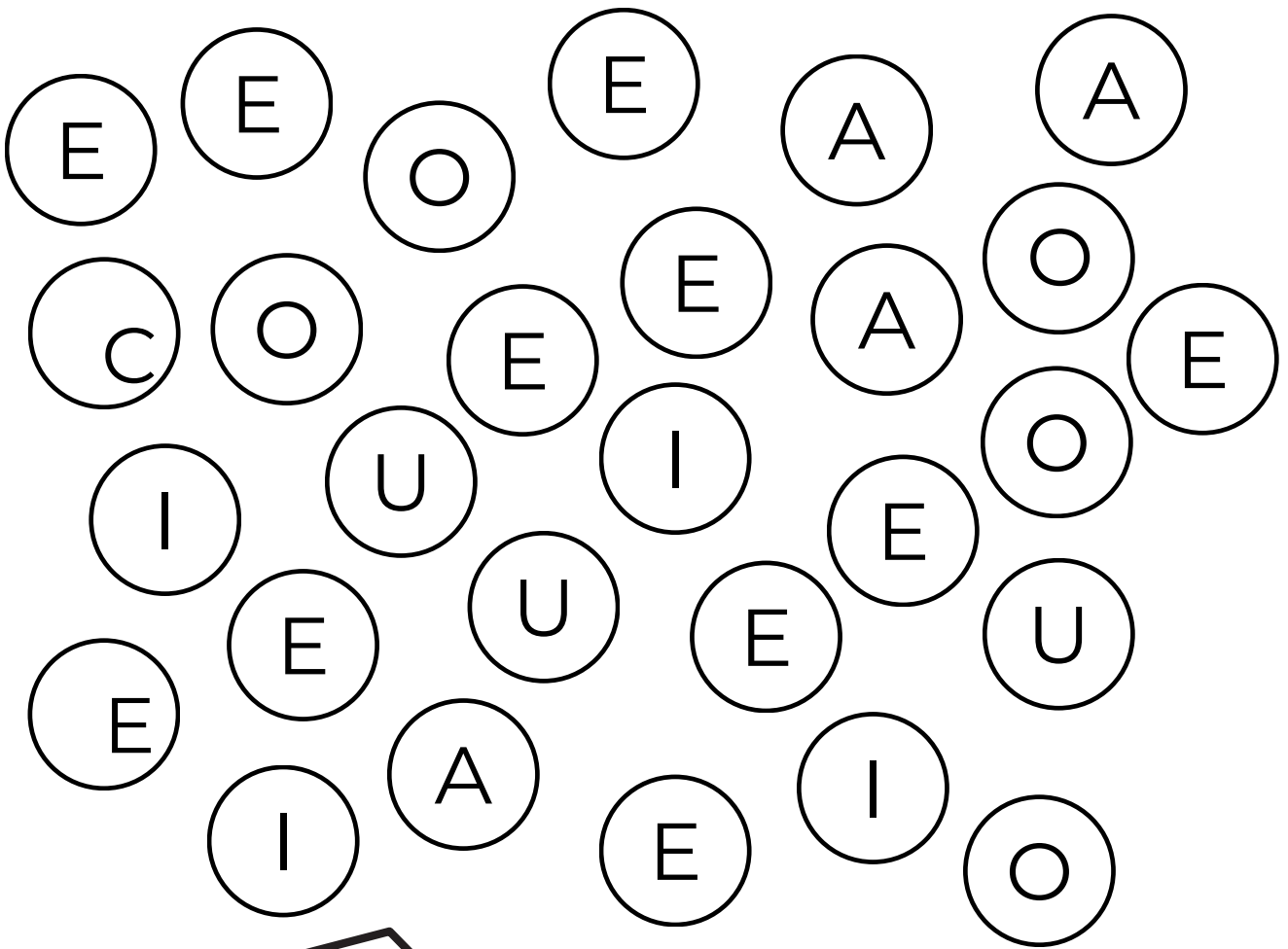

Nom \_\_\_\_\_

Date \_\_\_\_\_

## Colorie la lettre e

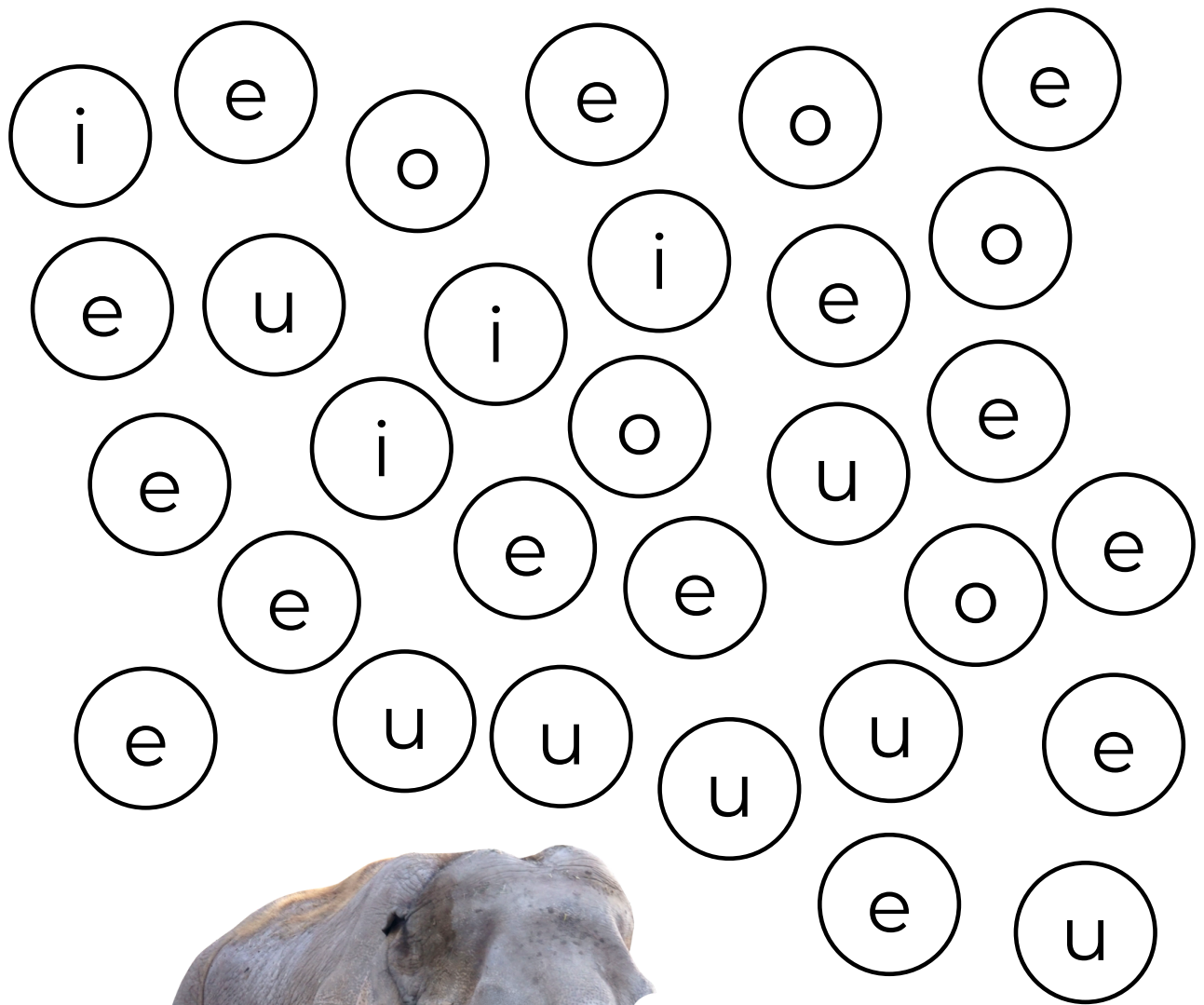

Eléphant / éléphant

Nom \_\_\_\_\_

Date \_\_\_\_\_

Repasse sur la lettre F / f

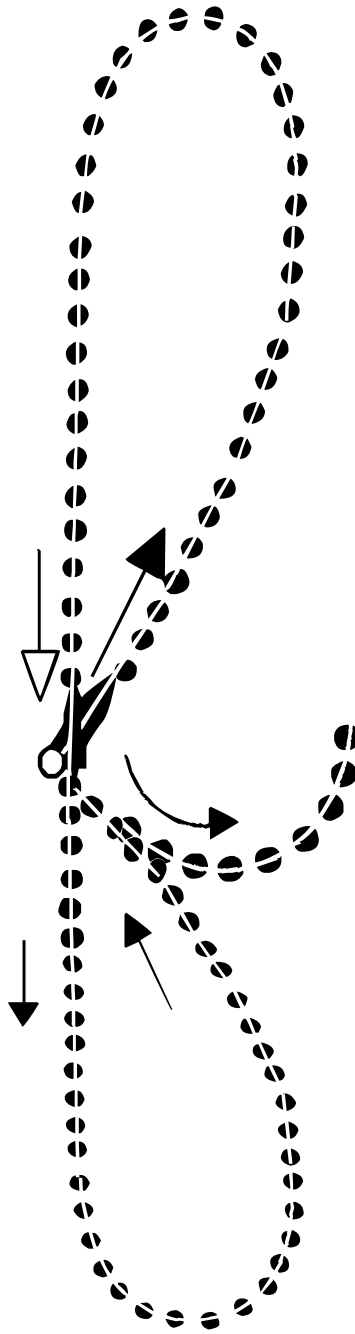

Nom \_\_\_\_\_

Date \_\_\_\_\_

Repasse sur la lettre F / f

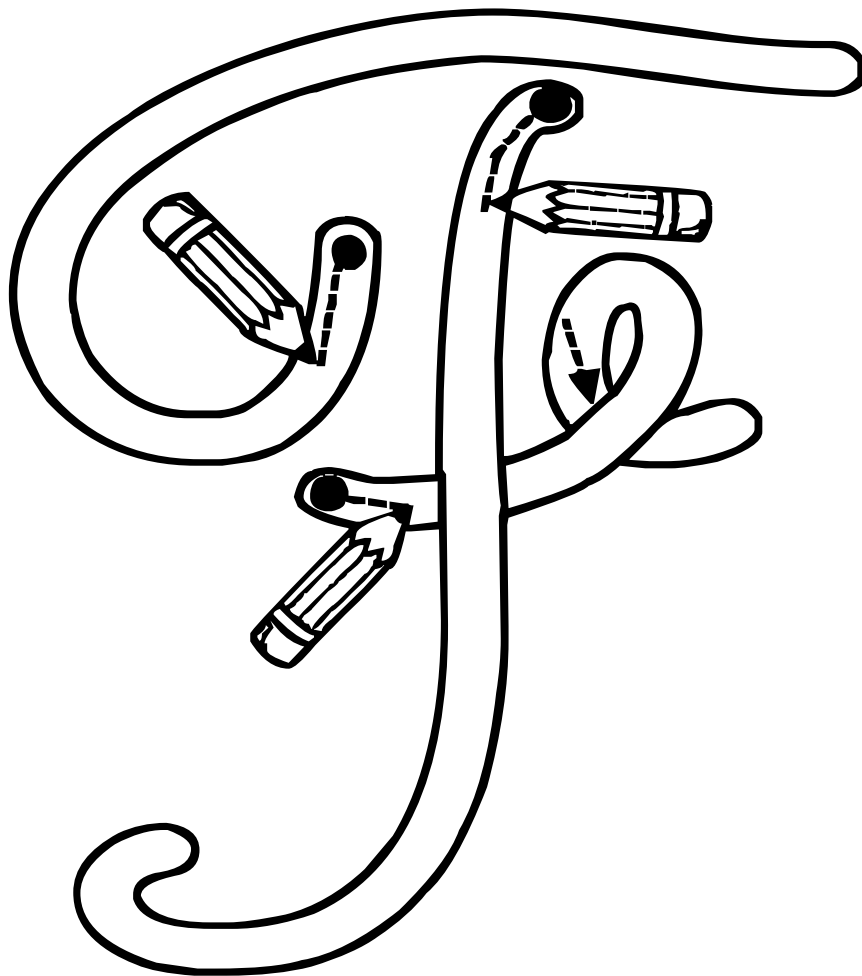

Nom \_\_\_\_\_

Date \_\_\_\_\_

Repasse sur la lettre F / f

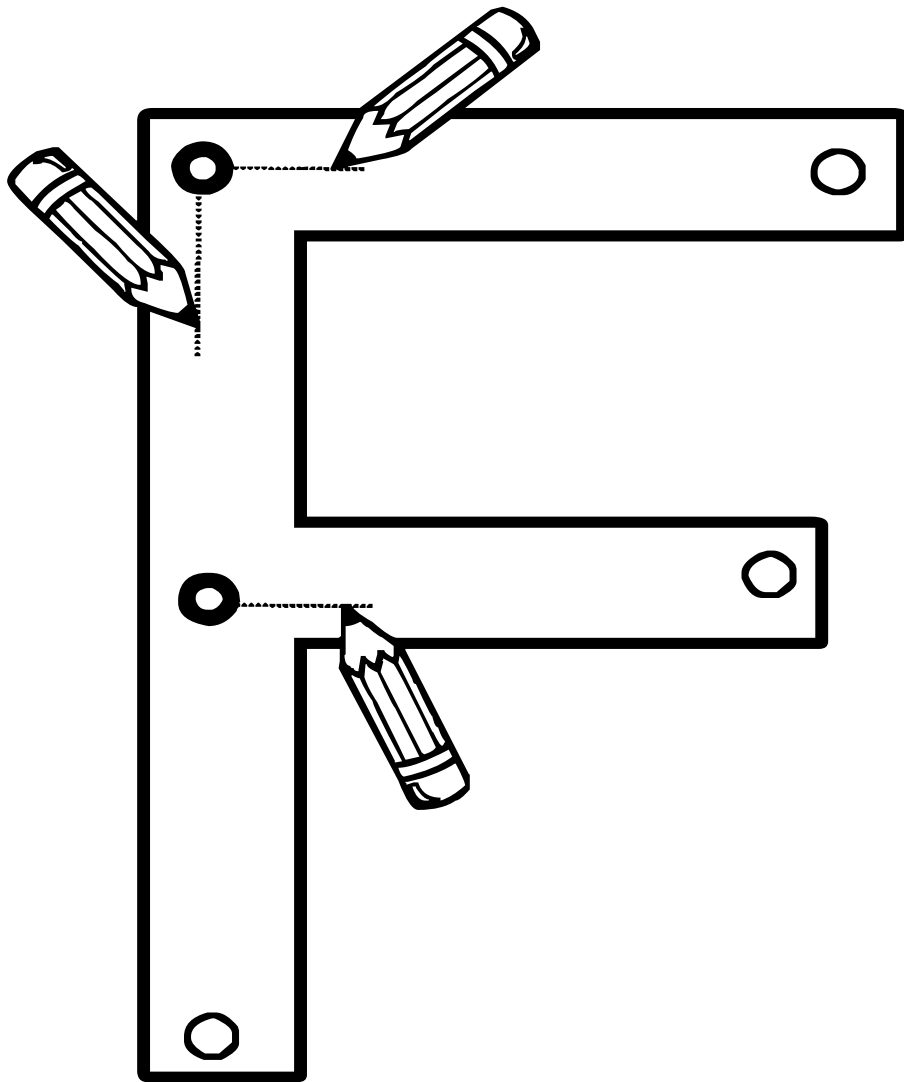

Nom \_\_\_\_\_

Date \_\_\_\_\_

# Ecris la lettre F / f

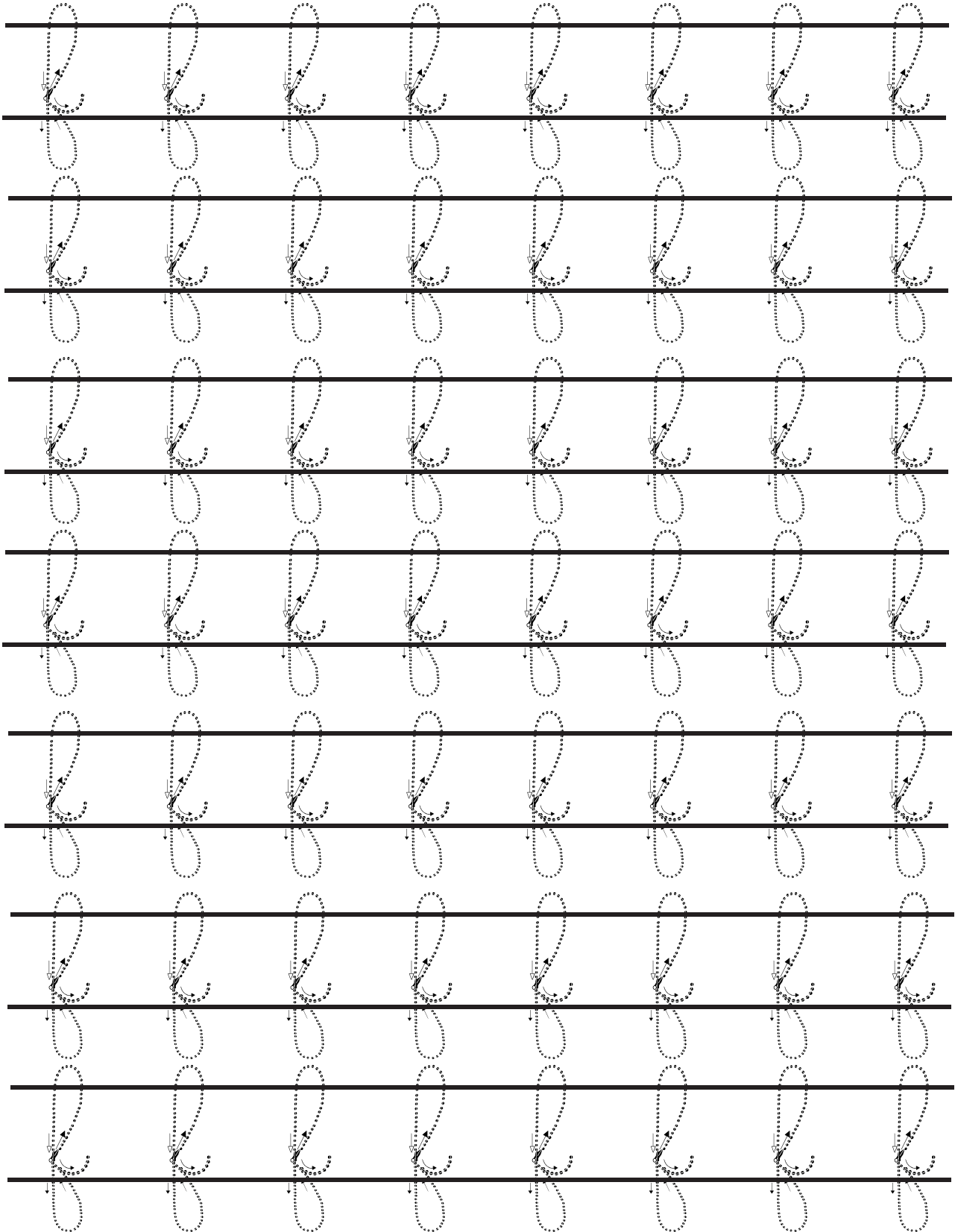

Nom \_\_\_\_\_

Date \_\_\_\_\_

# Ecris la lettre F / f

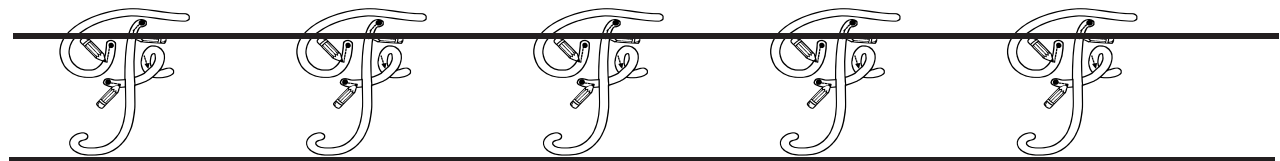
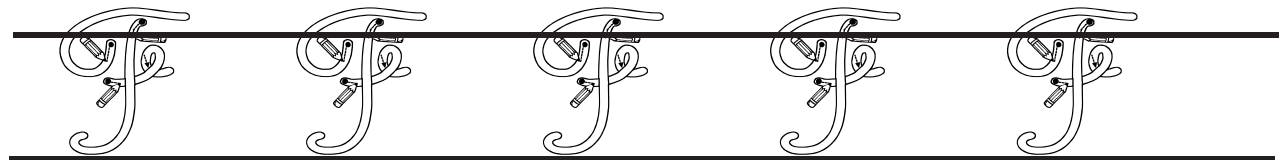
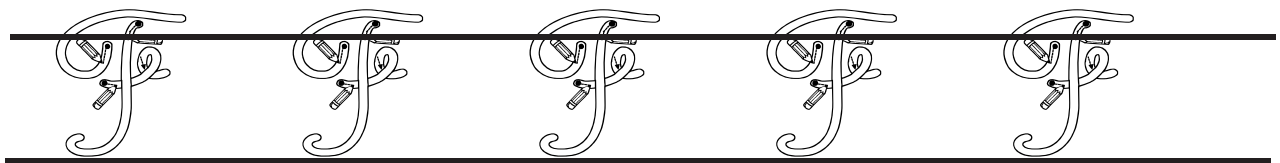
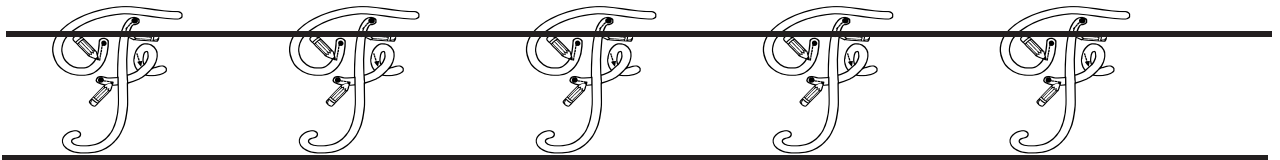
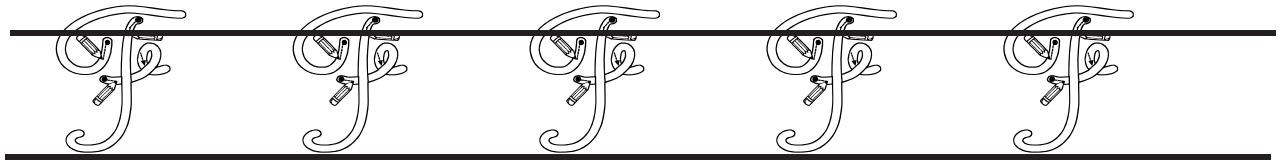
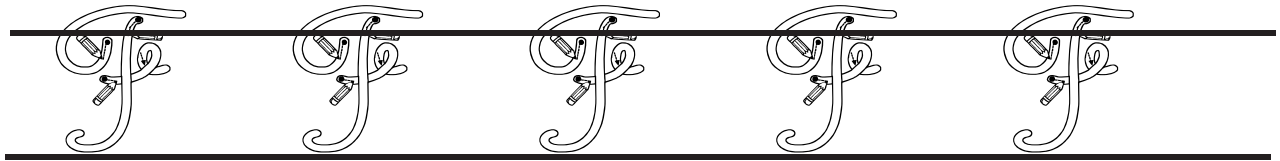
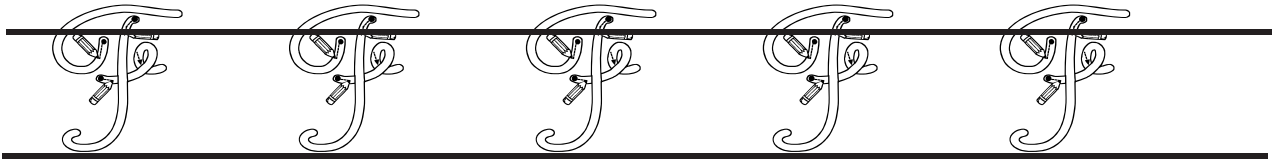

Nom \_\_\_\_\_

Date \_\_\_\_\_

# Ecris la lettre F/f

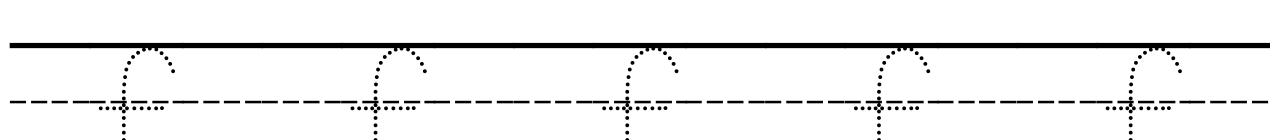
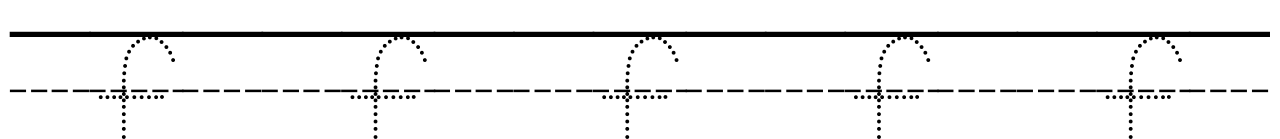
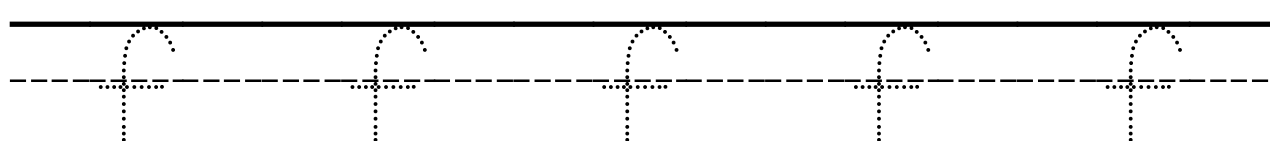
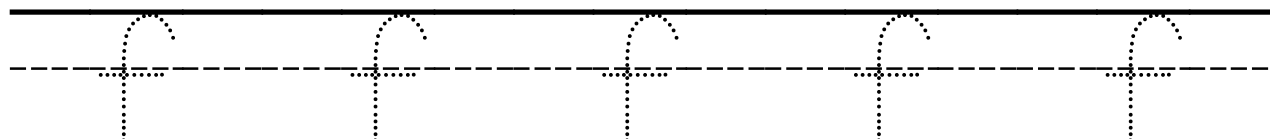
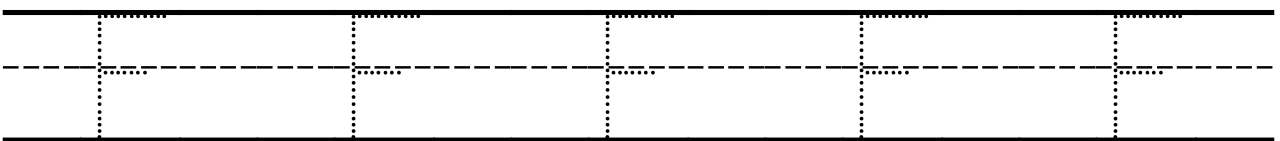
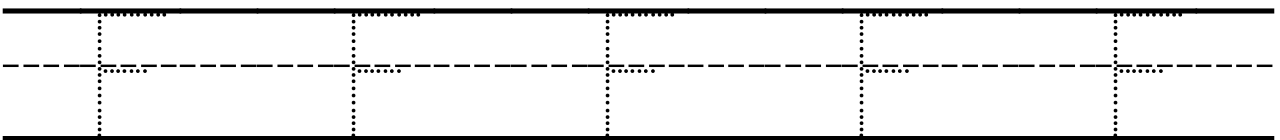
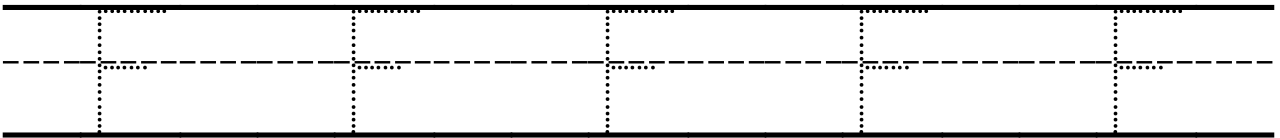
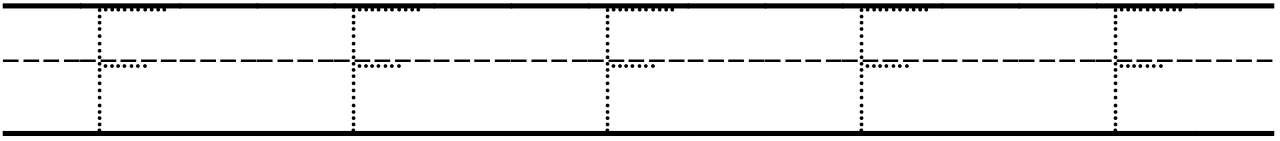

Nom \_\_\_\_\_ Date \_\_\_\_\_

Ecris la lettre F/f

F F F F F

Handwriting practice lines for uppercase 'F'. The first set consists of a solid top line, a dashed middle line, and a solid bottom line. The second set consists of a solid top line, a dashed middle line, and a solid bottom line.

f f f f f

Handwriting practice lines for lowercase 'f'. The first set consists of a solid top line, a dashed middle line, and a solid bottom line. The second set consists of a solid top line, a dashed middle line, and a solid bottom line.

Nom \_\_\_\_\_

Date \_\_\_\_\_

## Colorie la lettre F

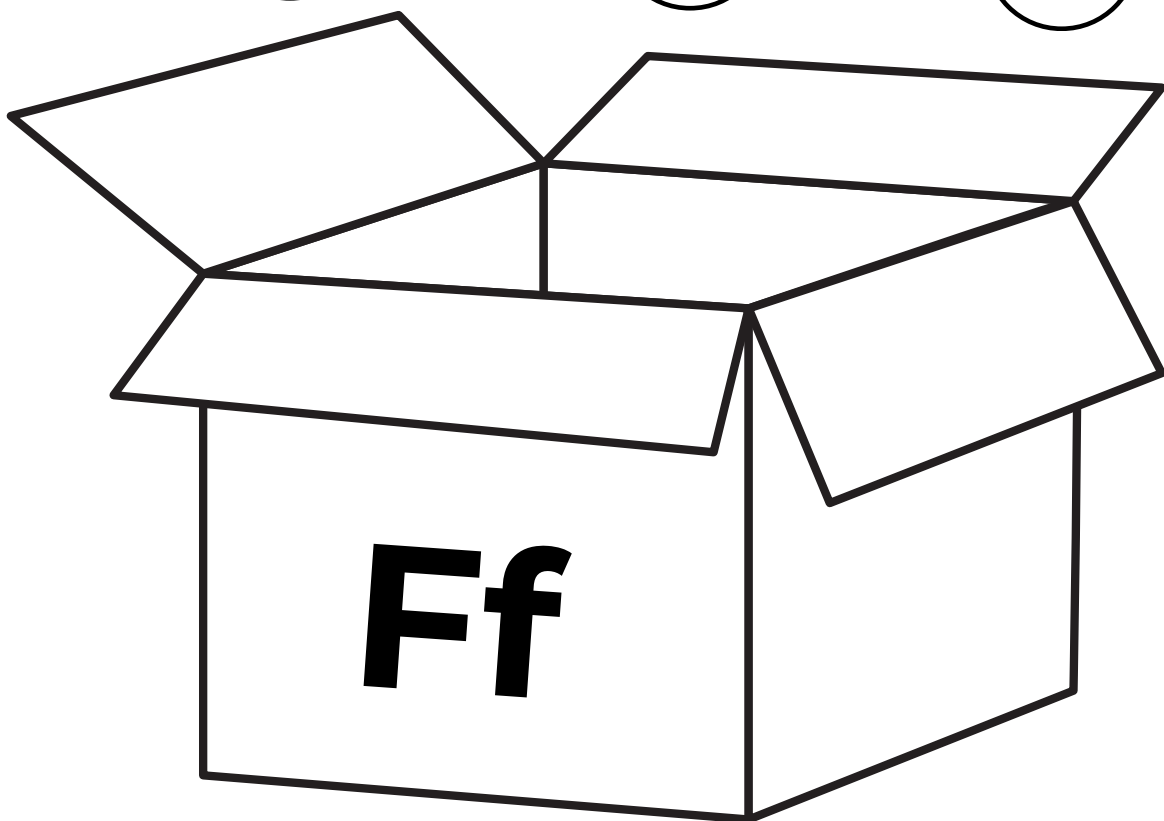
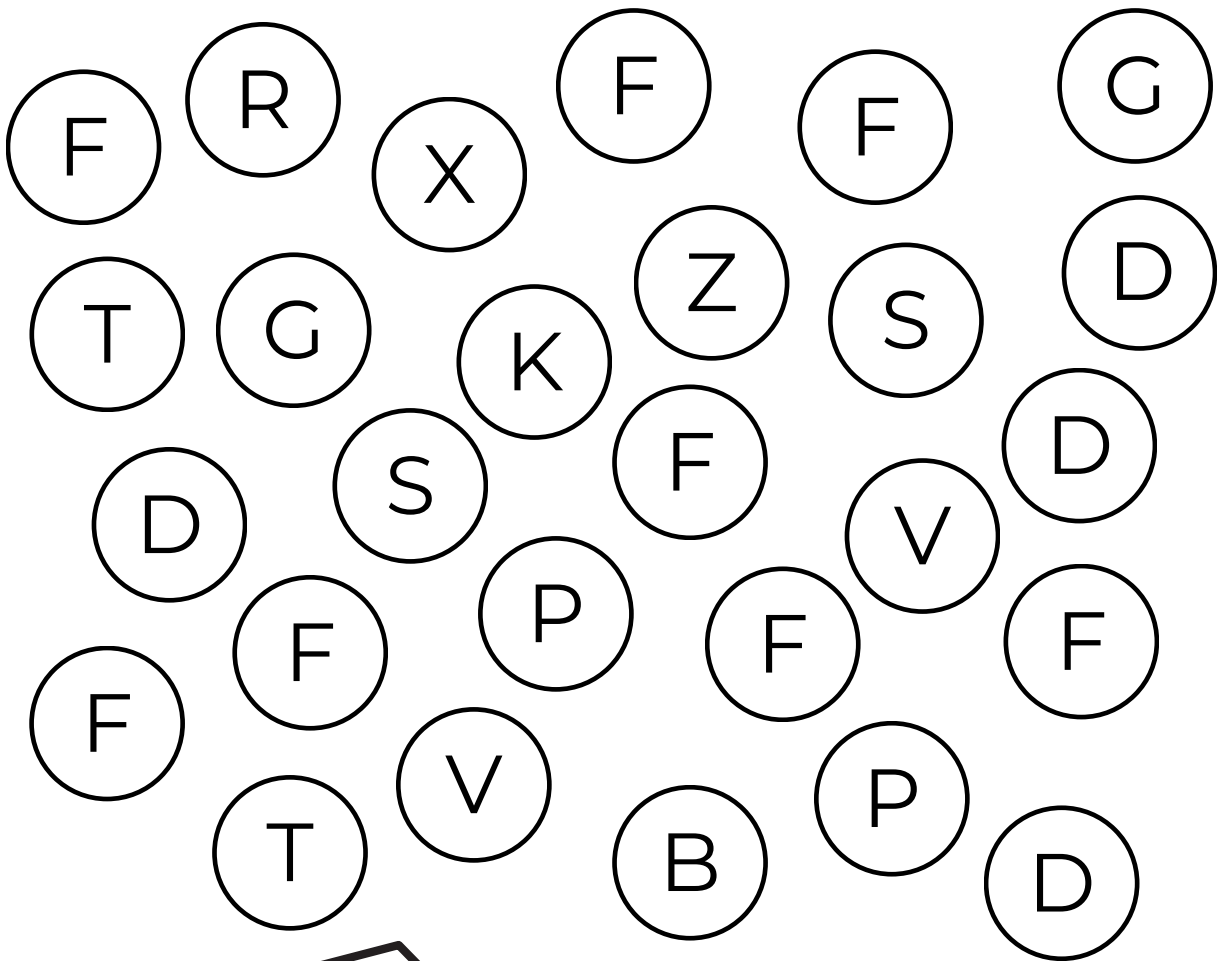

Nom \_\_\_\_\_

Date \_\_\_\_\_

## Colorie la lettre f

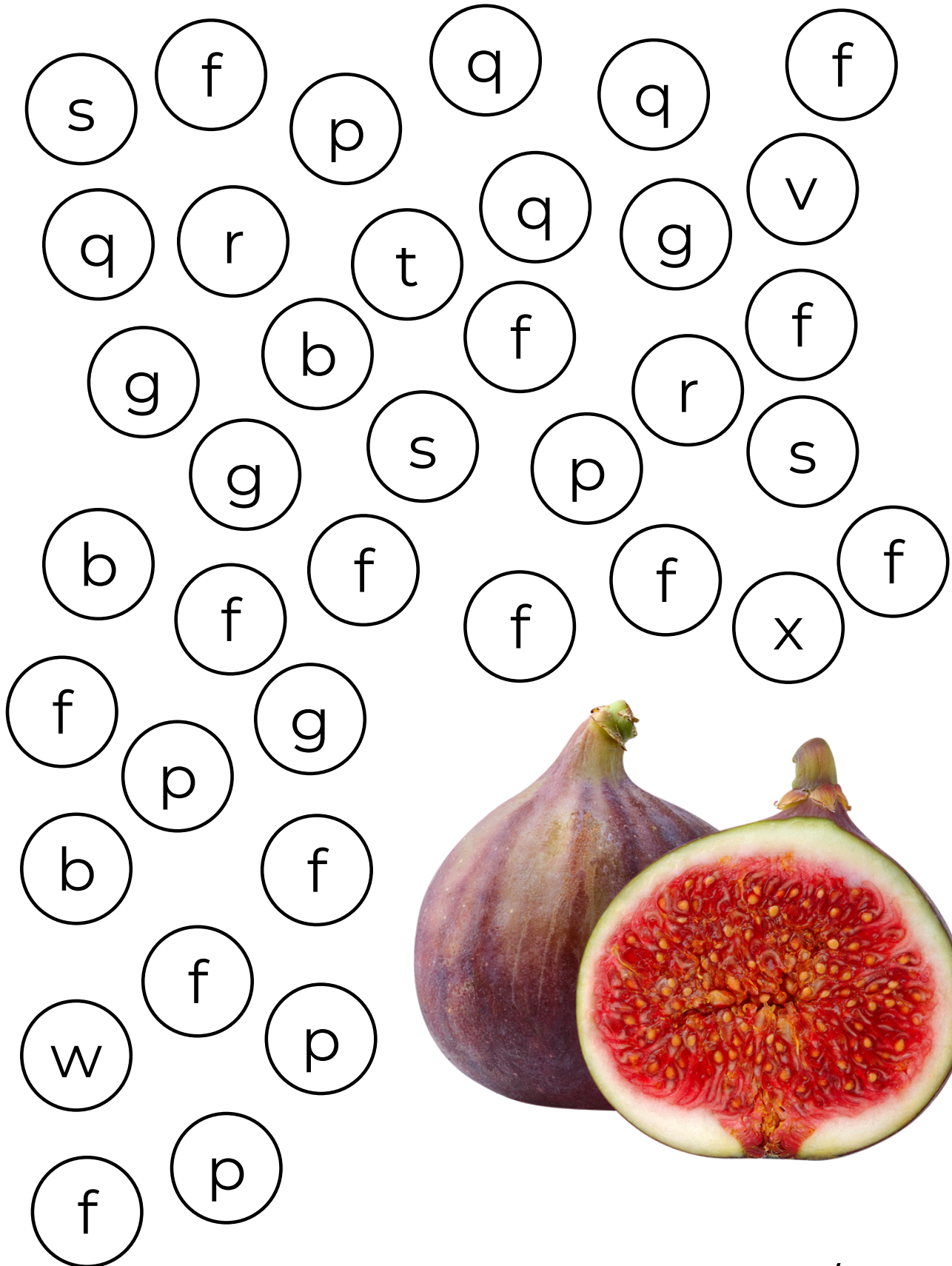

FIGUE / figue

Nom \_\_\_\_\_

Date \_\_\_\_\_

Repasse sur la lettre G / g

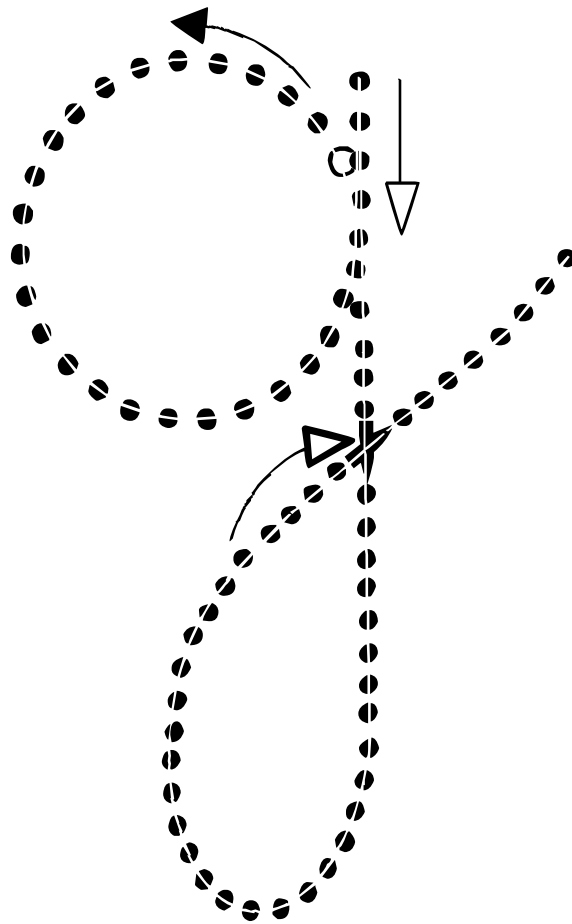

Nom \_\_\_\_\_

Date \_\_\_\_\_

Repasse sur la lettre G / g

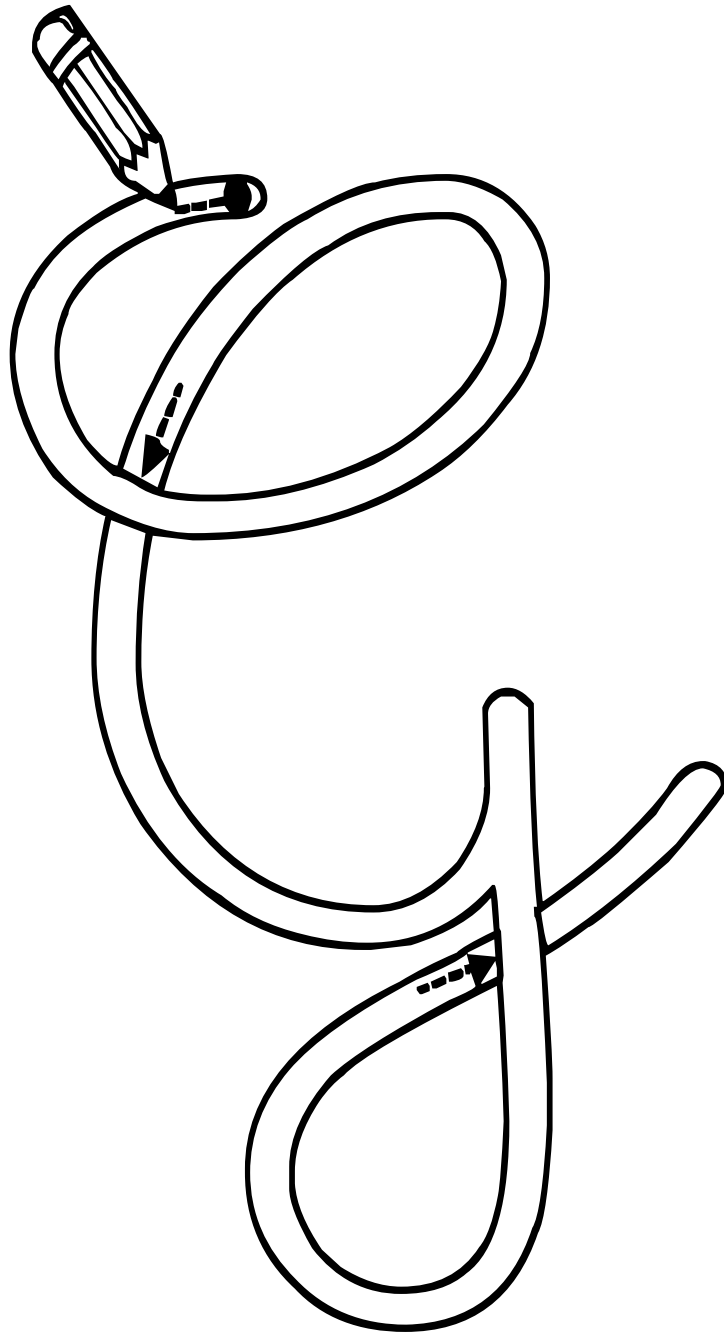

Nom \_\_\_\_\_

Date \_\_\_\_\_

Repasse sur la lettre G / g

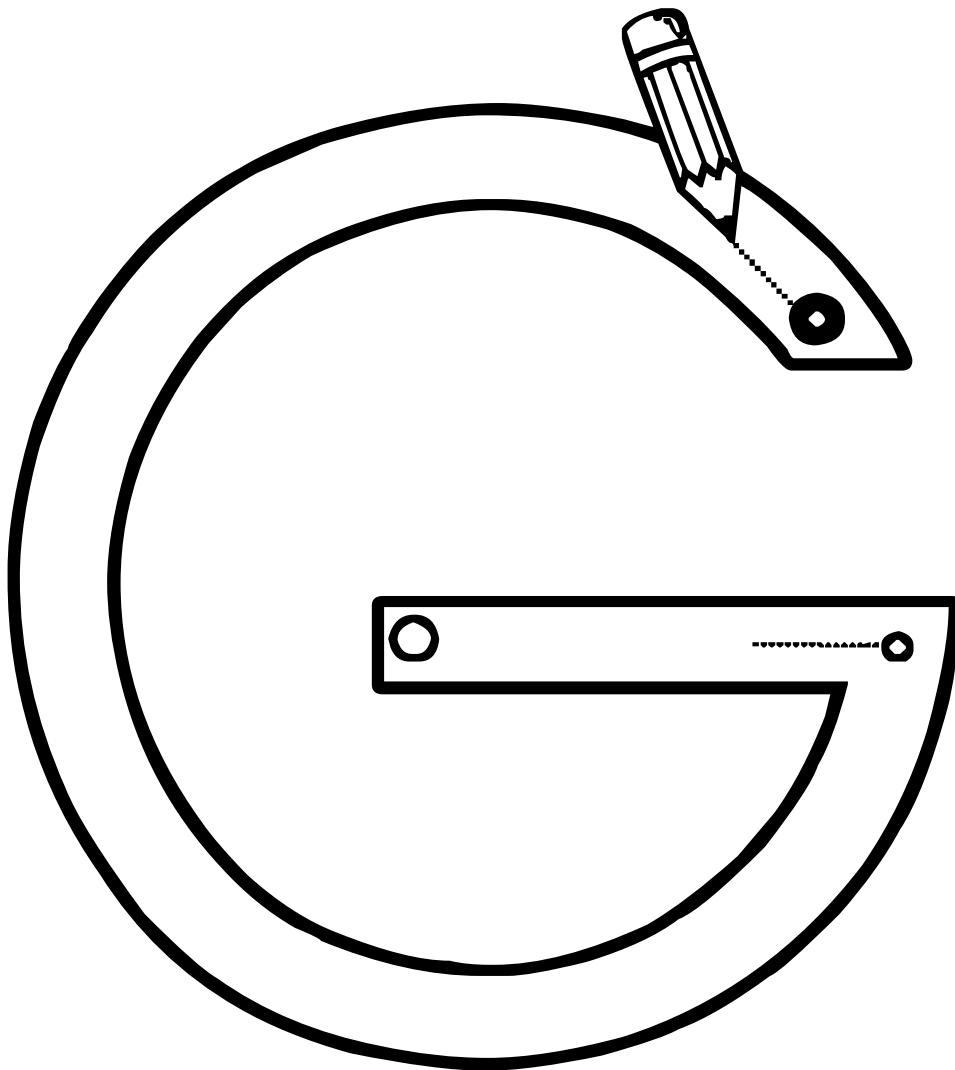

Nom \_\_\_\_\_

Date \_\_\_\_\_

# Ecris la lettre G / g

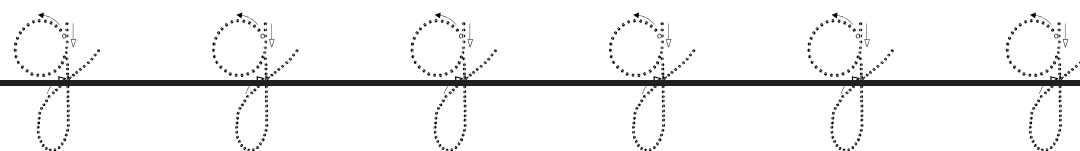
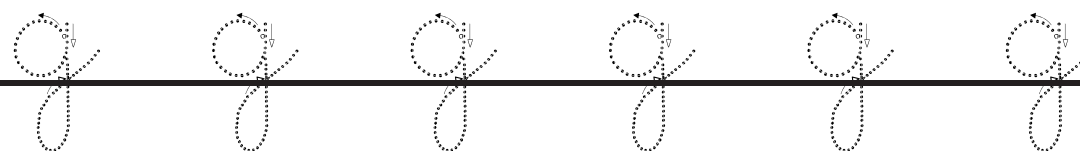
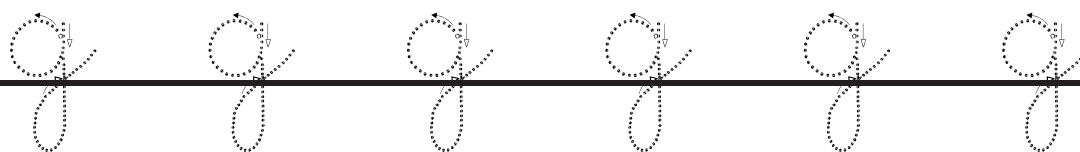
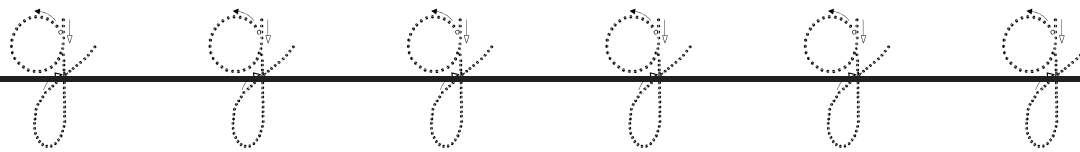
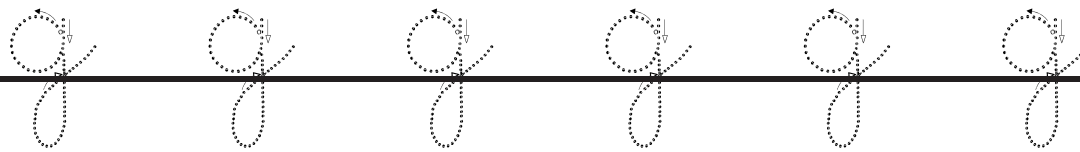

Nom \_\_\_\_\_

Date \_\_\_\_\_

# Ecris la lettre G / g

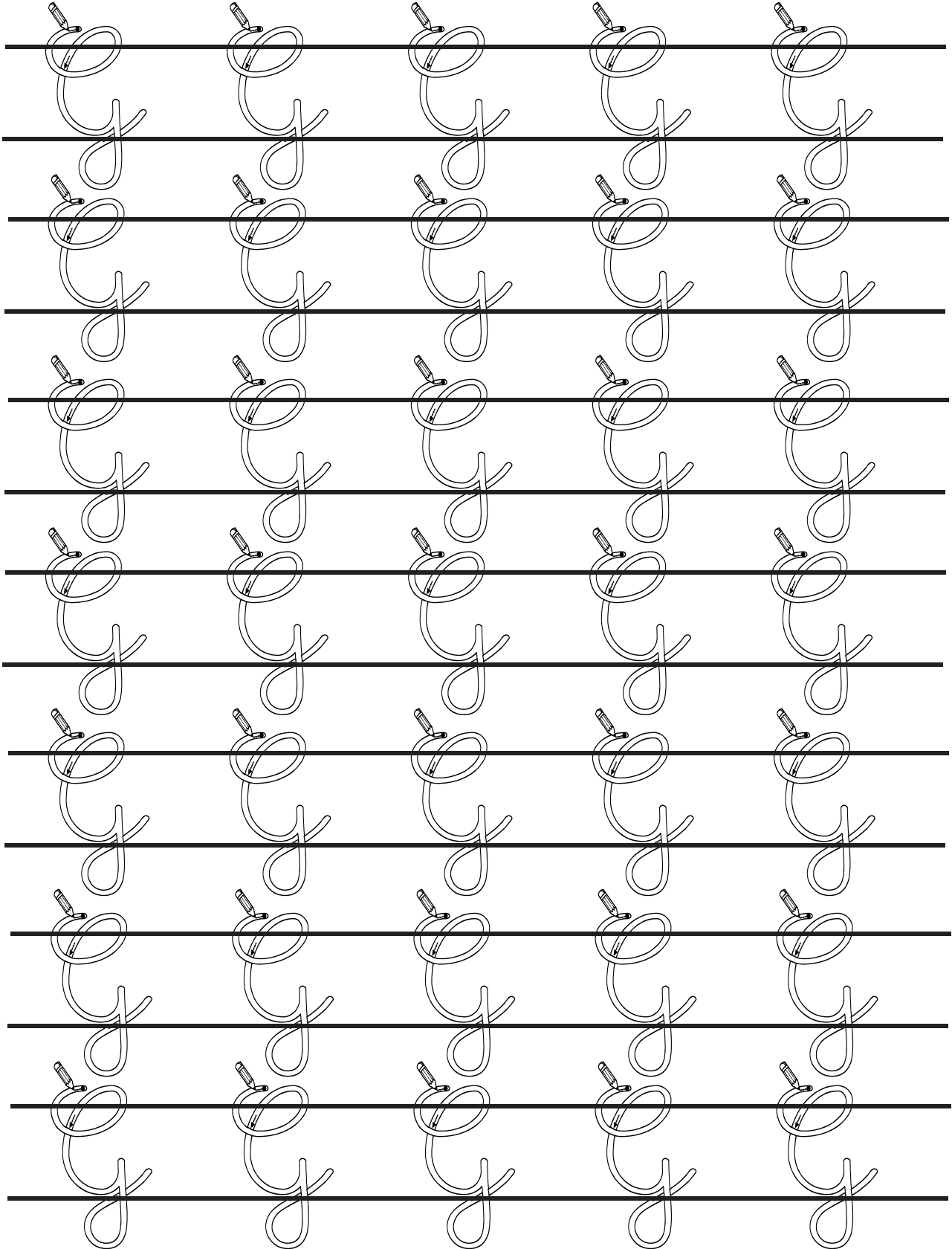

Nom \_\_\_\_\_ Date \_\_\_\_\_

## Ecris la lettre G/g

G G G G G

G G G G G

G G G G G

G G G G G

g g g g g

g g g g g

g g g g g

g g g g g

Nom \_\_\_\_\_ Date \_\_\_\_\_

Ecris la lettre G/g

G G G G G

Handwriting practice lines for uppercase letter G. The first set of lines is a solid top line, a dashed middle line, and a solid bottom line. The second set of lines is a solid top line, a dashed middle line, and a solid bottom line.

g g g g g

Handwriting practice lines for lowercase letter g. The first set of lines is a solid top line, a dashed middle line, and a solid bottom line. The second set of lines is a solid top line, a dashed middle line, and a solid bottom line.

Nom \_\_\_\_\_

Date \_\_\_\_\_

## Colorie la lettre G

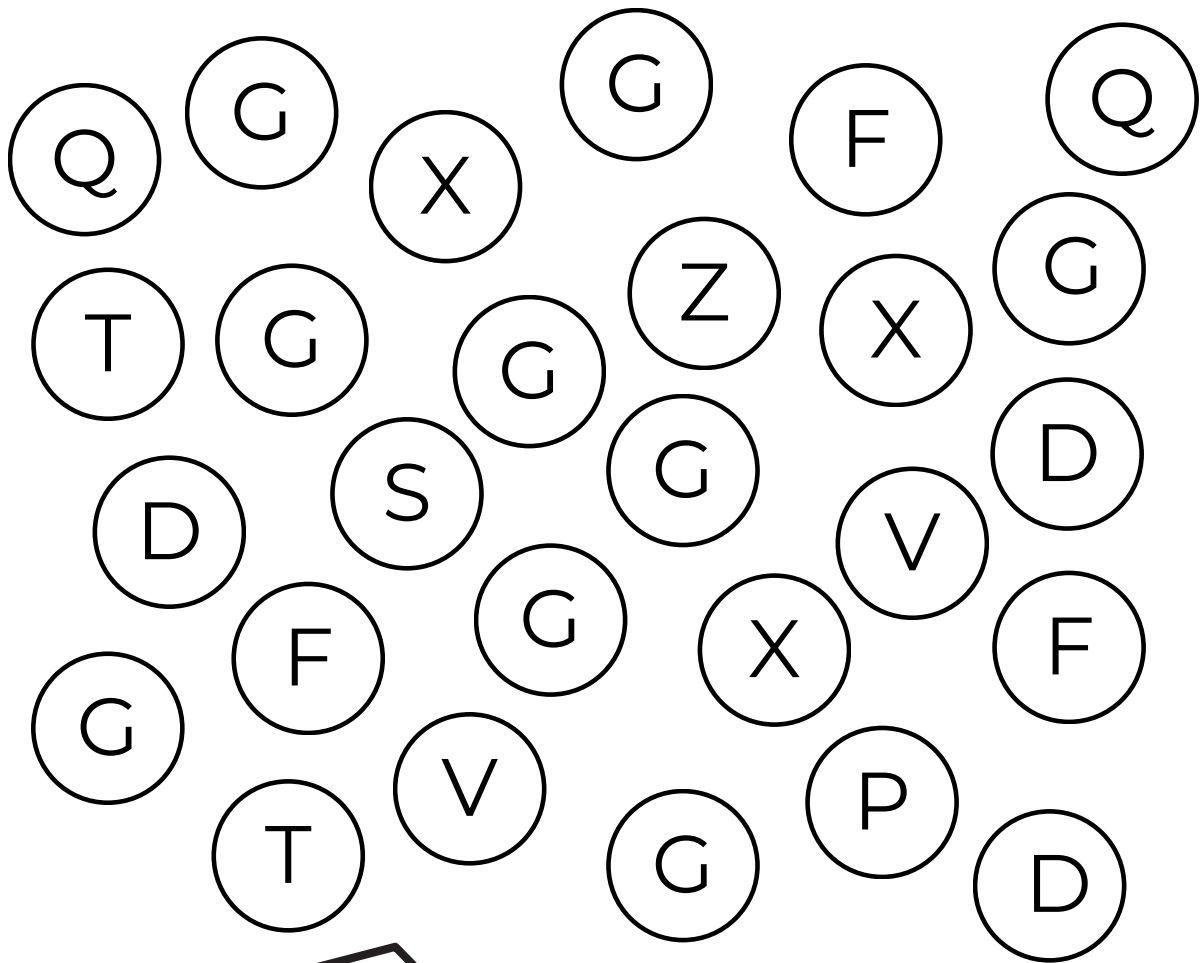

Nom \_\_\_\_\_

Date \_\_\_\_\_

## Colorie la lettre g

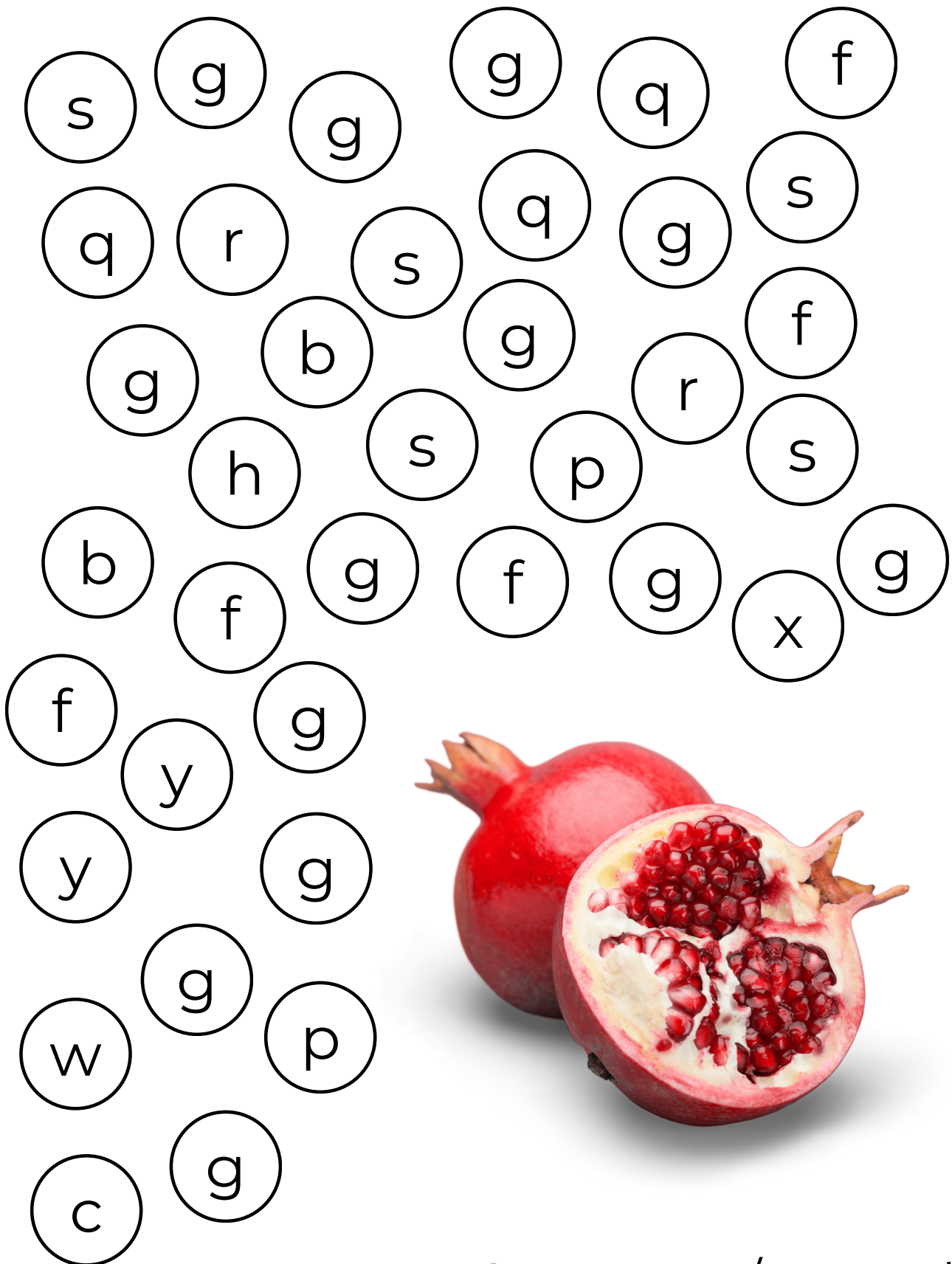

GRENADE / grenade

Nom \_\_\_\_\_

Date \_\_\_\_\_

Repasse sur la lettre H / h

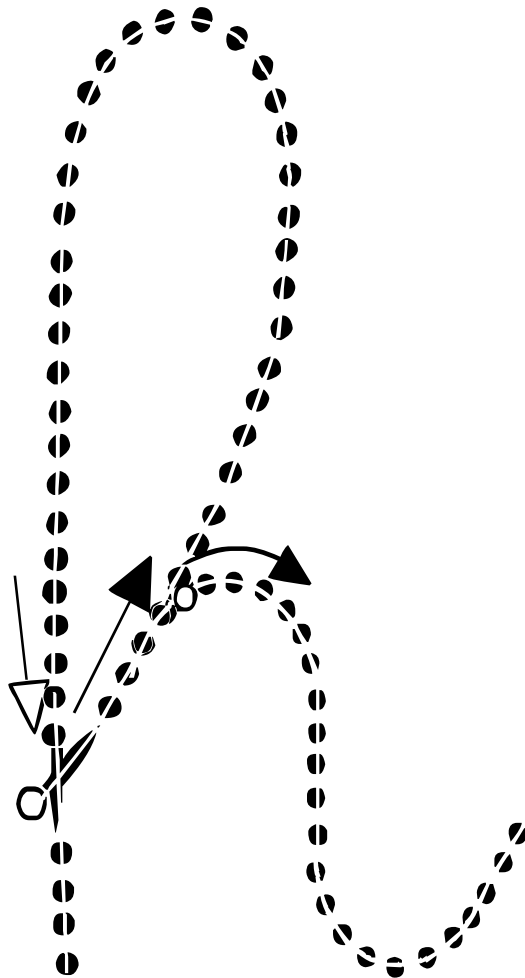

Nom \_\_\_\_\_

Date \_\_\_\_\_

Repasse sur la lettre H / h

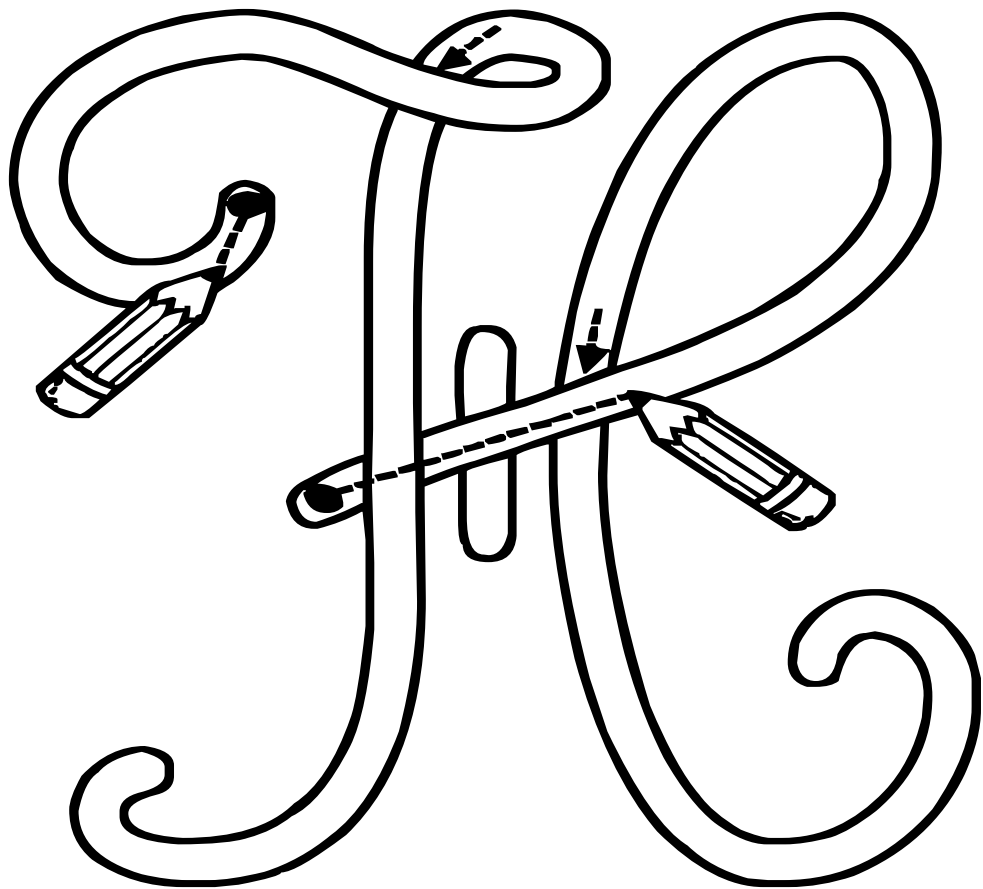

Nom \_\_\_\_\_

Date \_\_\_\_\_

Repasse sur la lettre H / h

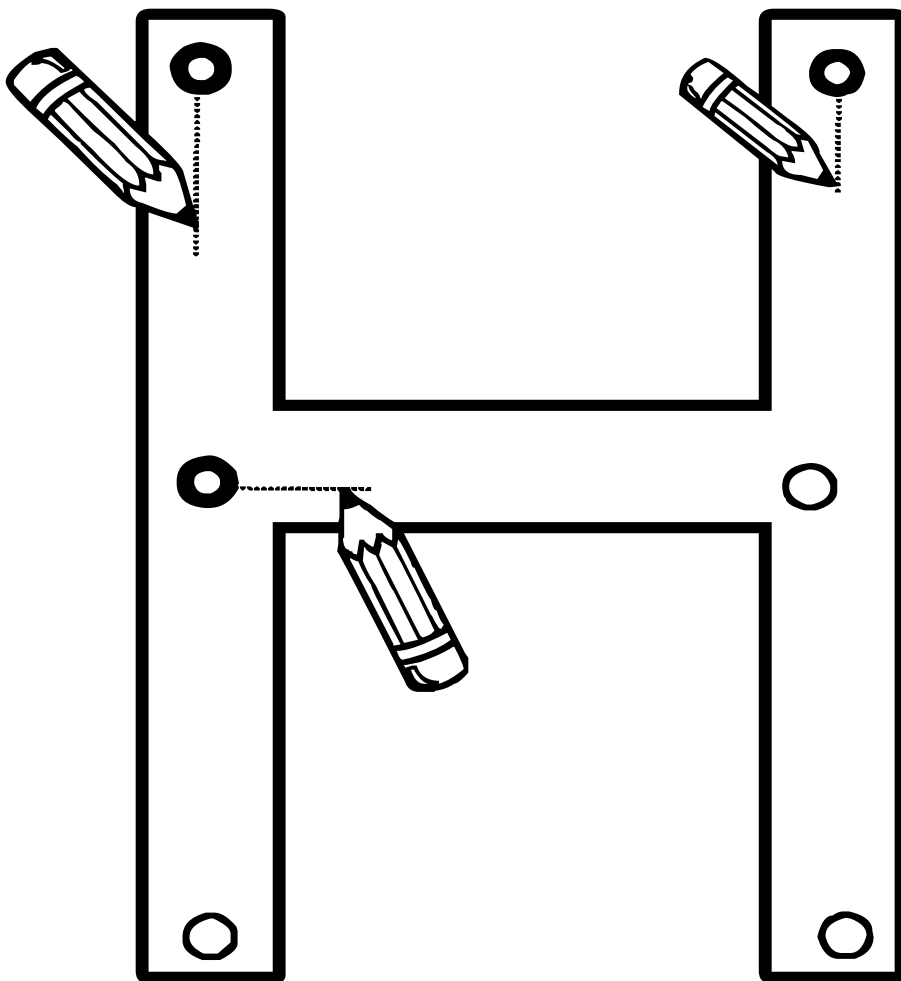

Nom \_\_\_\_\_

Date \_\_\_\_\_

## Ecris la lettre H / h

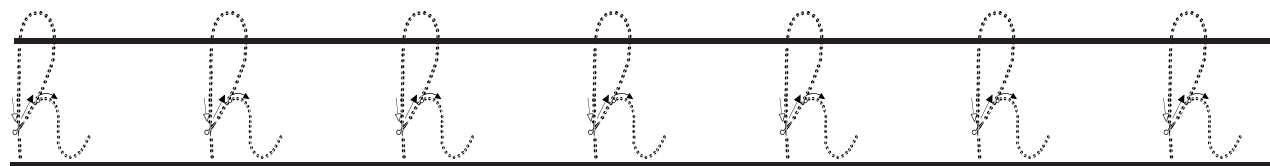
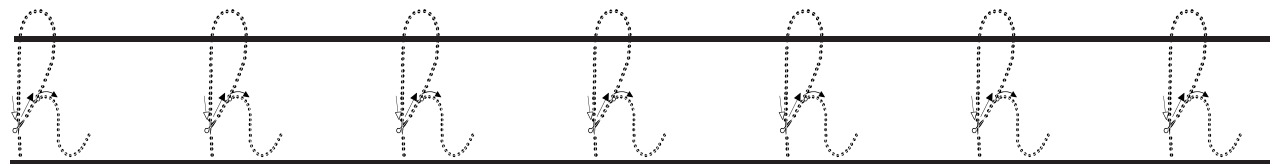
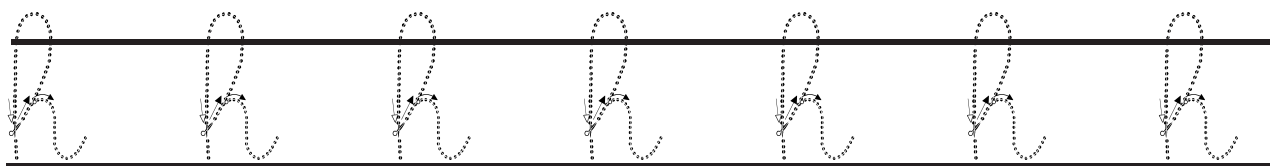
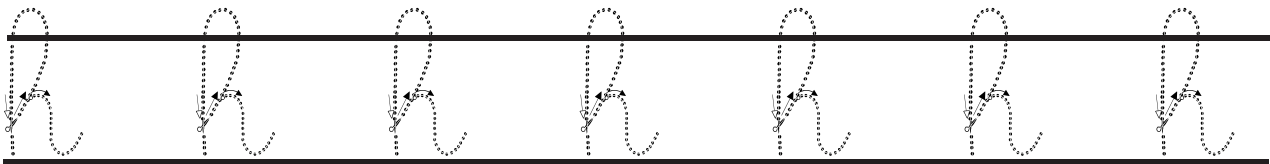
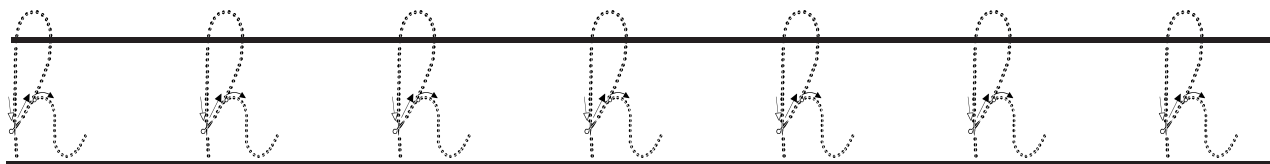
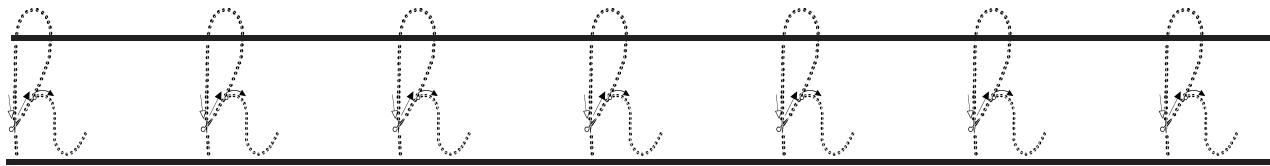
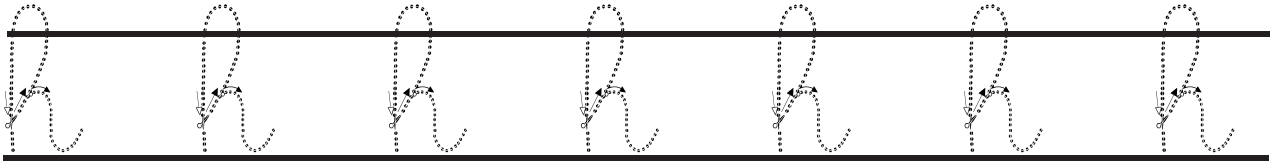



Nom \_\_\_\_\_

Date \_\_\_\_\_

# Ecris la lettre H/h

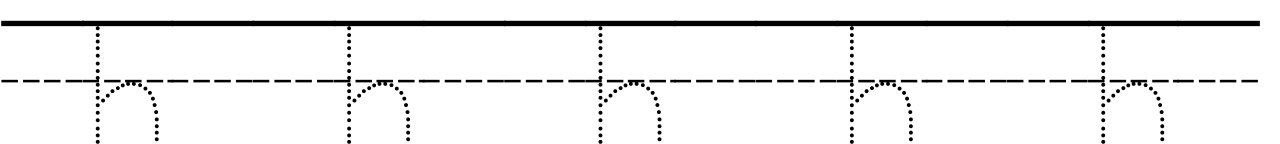
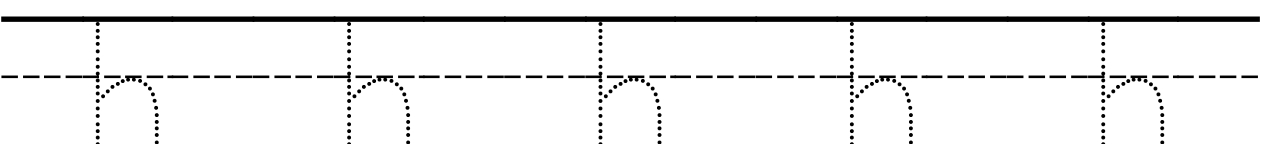
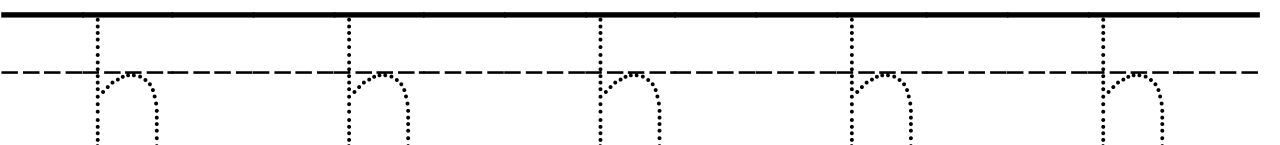
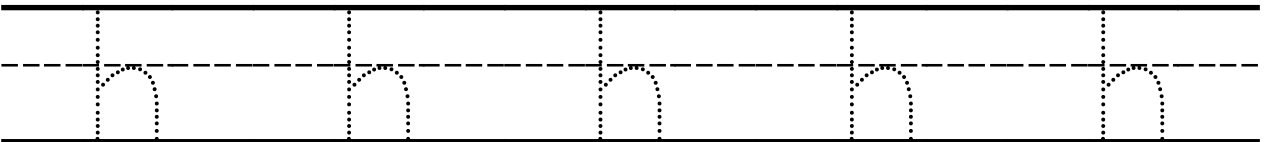
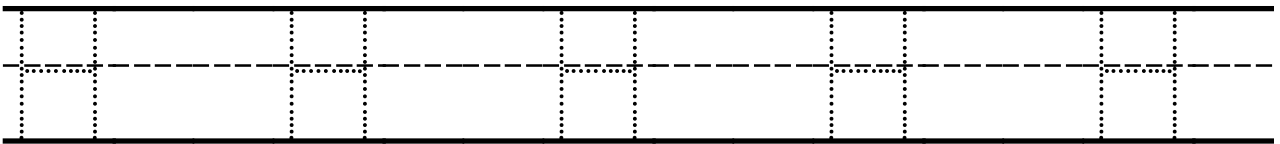
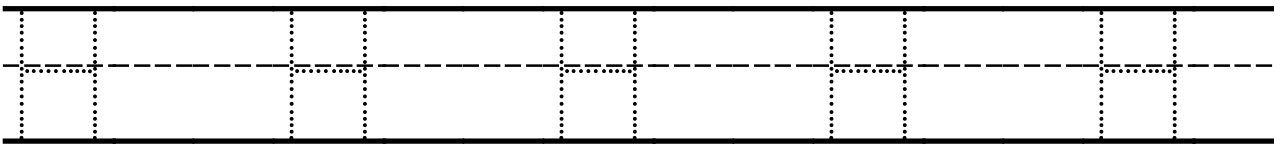
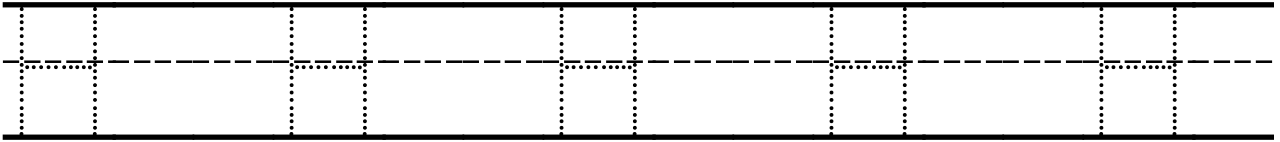
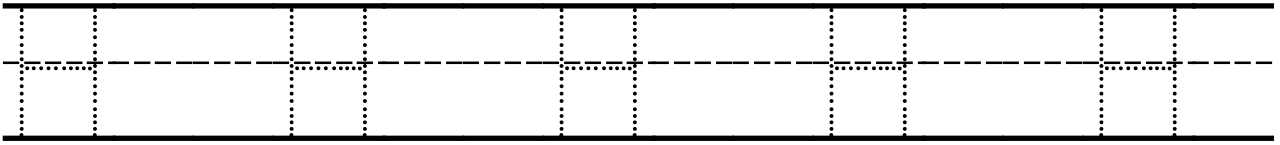

Nom \_\_\_\_\_ Date \_\_\_\_\_

Ecris la lettre H/h

H H H H H

Handwriting practice lines for uppercase 'H'. The first set of lines is a solid top line, a dashed middle line, and a solid bottom line. Below it is another identical set of lines.

h h h h h

Handwriting practice lines for lowercase 'h'. The first set of lines is a solid top line, a dashed middle line, and a solid bottom line. Below it is another identical set of lines.

Nom \_\_\_\_\_

Date \_\_\_\_\_

## Colorie la lettre H

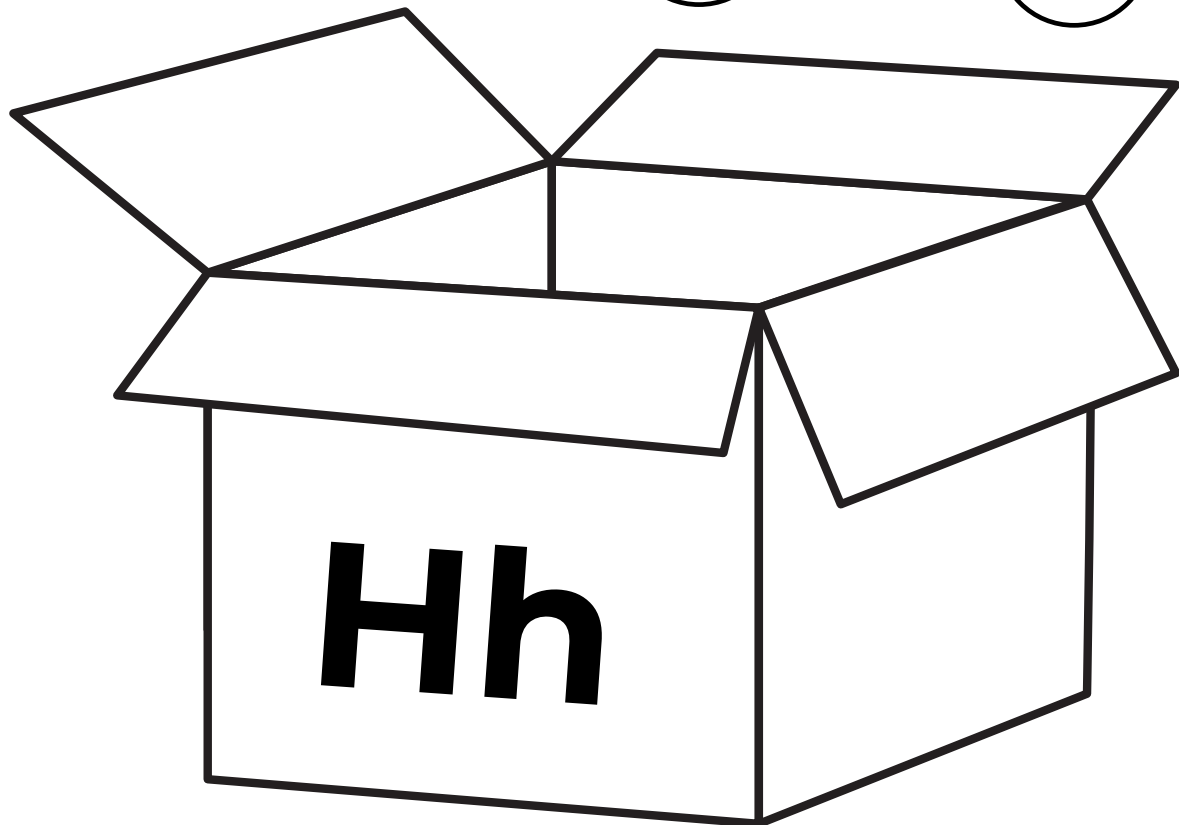
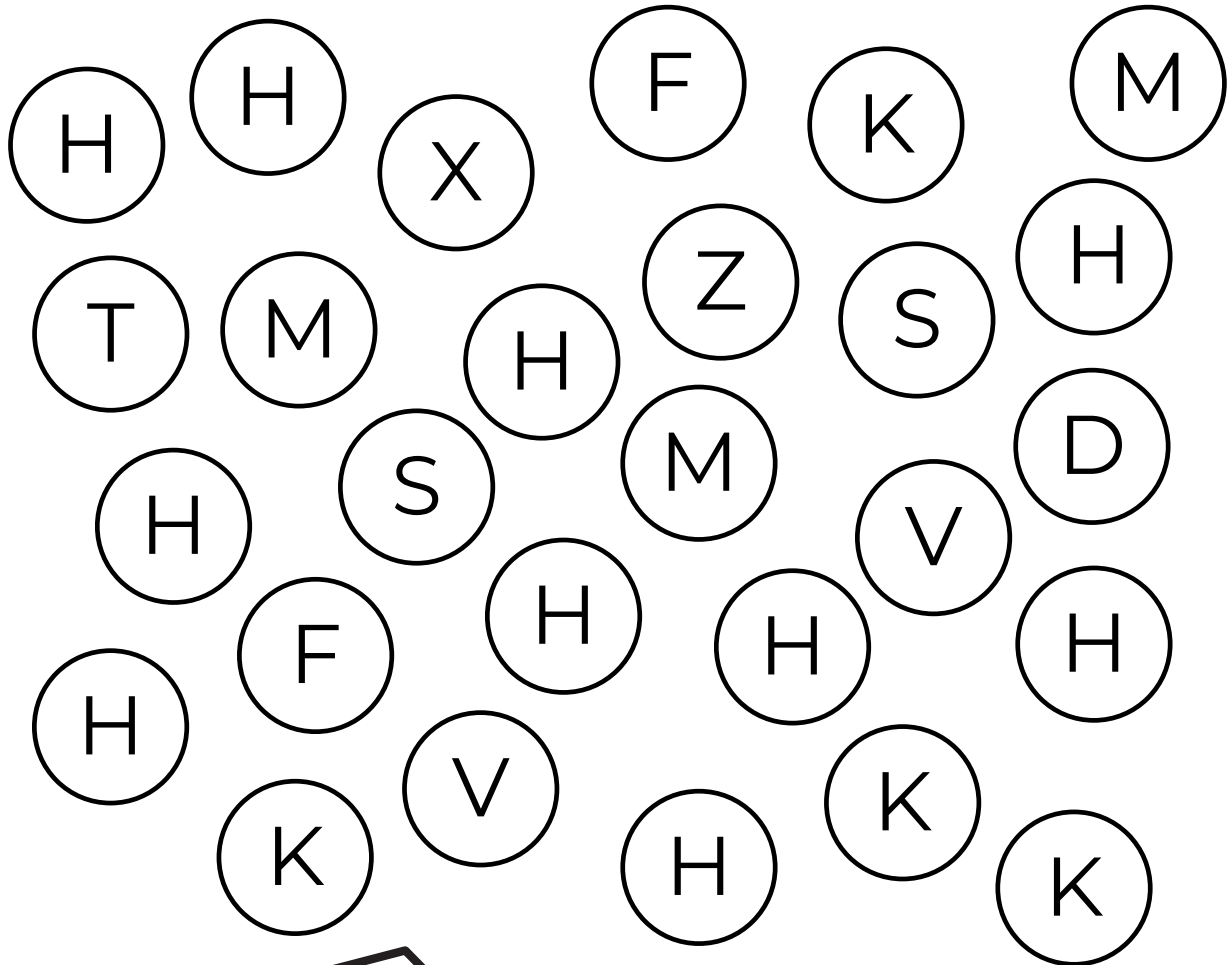

Nom \_\_\_\_\_

Date \_\_\_\_\_

## Colorie la lettre h

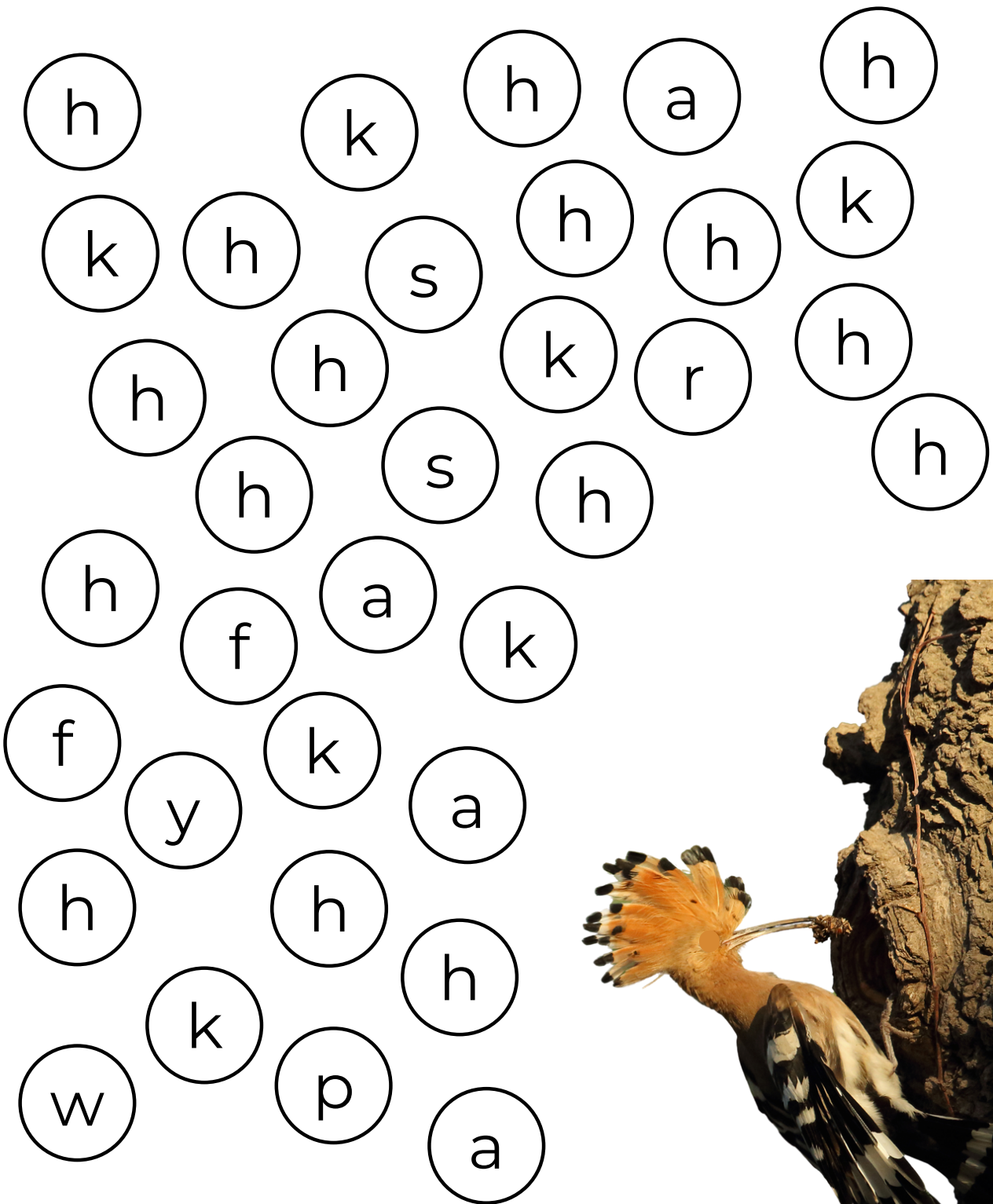

HUPPE / huppe

Nom \_\_\_\_\_

Date \_\_\_\_\_

Repasse sur la lettre l / i

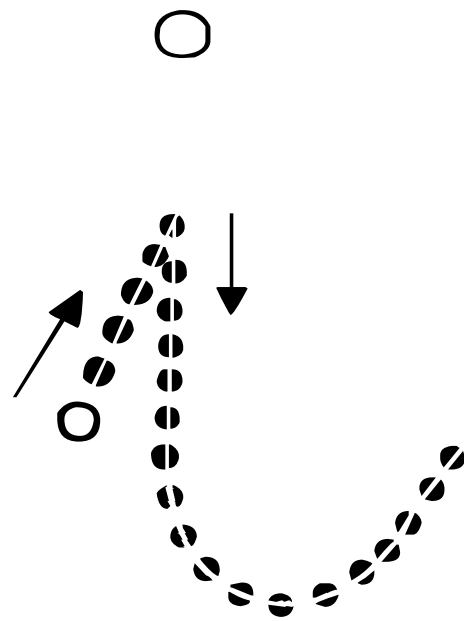

Nom \_\_\_\_\_

Date \_\_\_\_\_

Repasse sur la lettre I / i

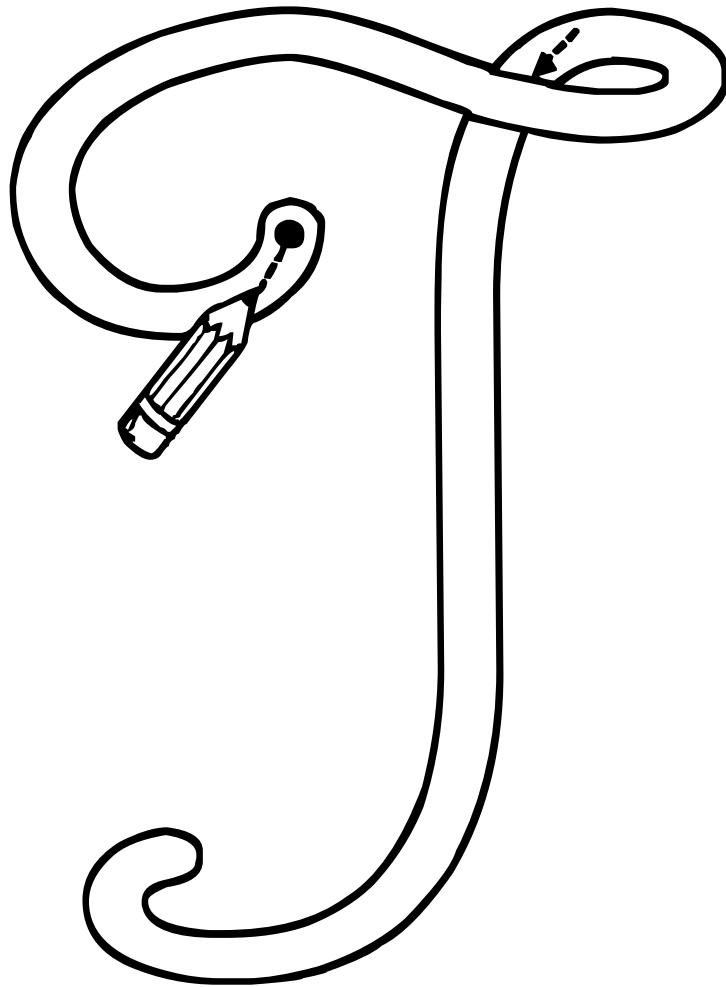

Nom \_\_\_\_\_

Date \_\_\_\_\_

Repasse sur la lettre l / i

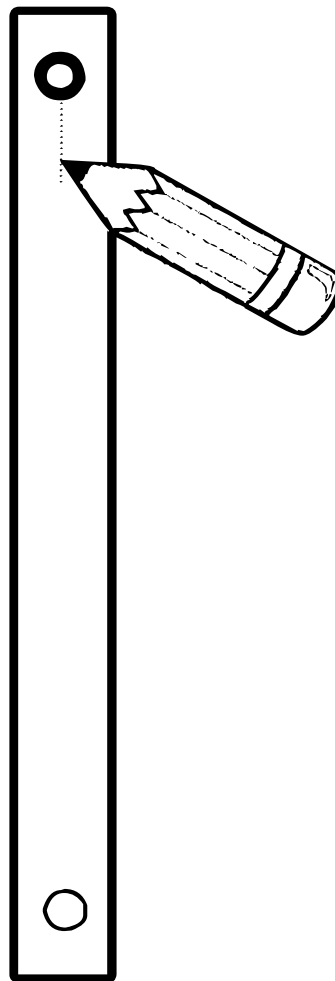

Nom \_\_\_\_\_

Date \_\_\_\_\_

# Ecris la lettre l / i

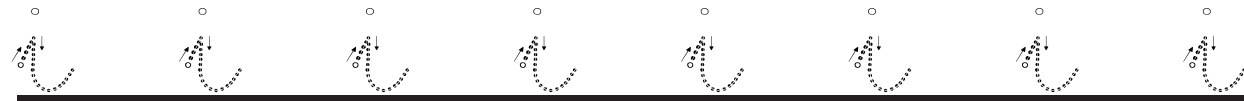

Nom \_\_\_\_\_

Date \_\_\_\_\_

# Ecris la lettre l / i

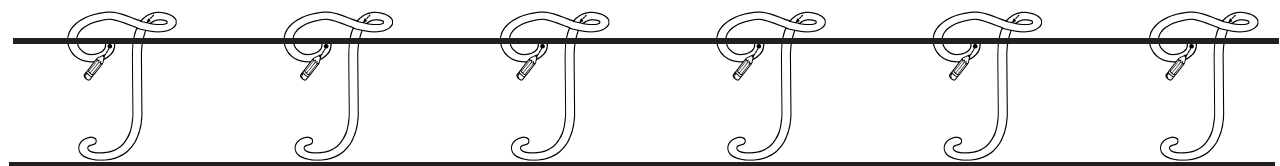
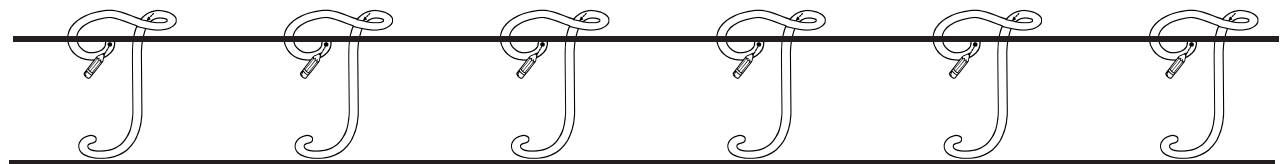
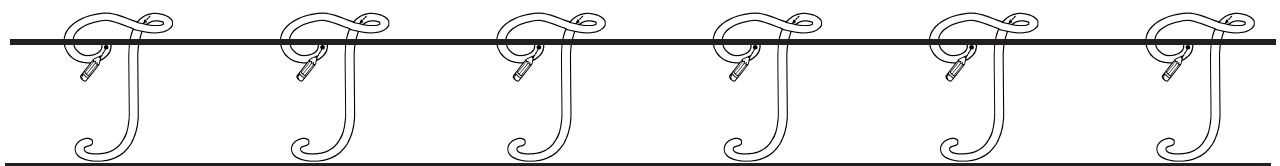
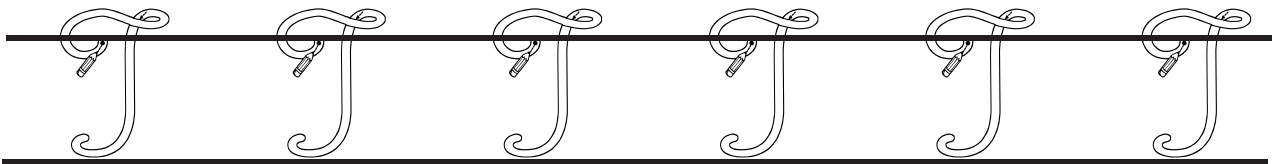
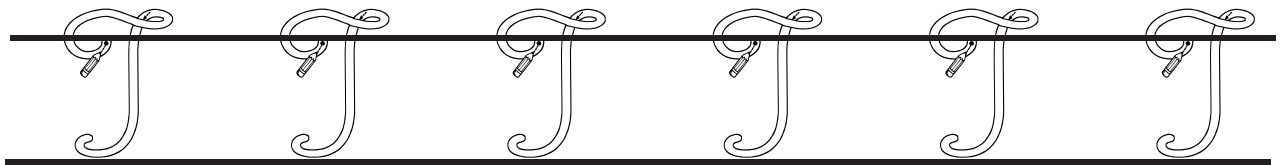
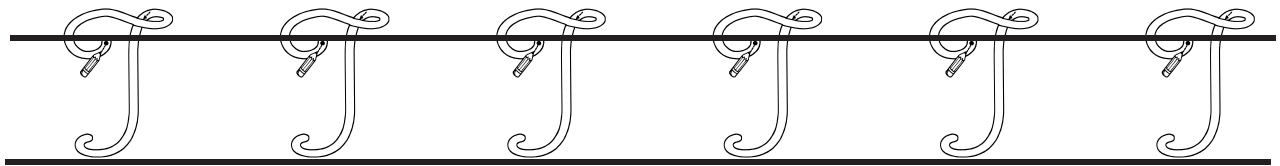
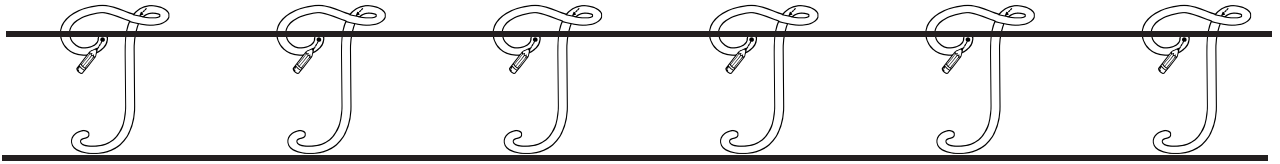

Nom \_\_\_\_\_

Date \_\_\_\_\_

# Ecris la lettre l/i

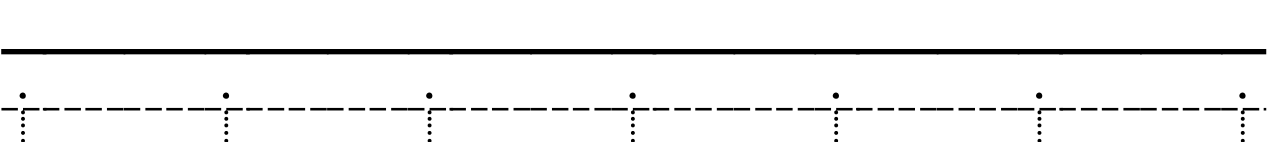
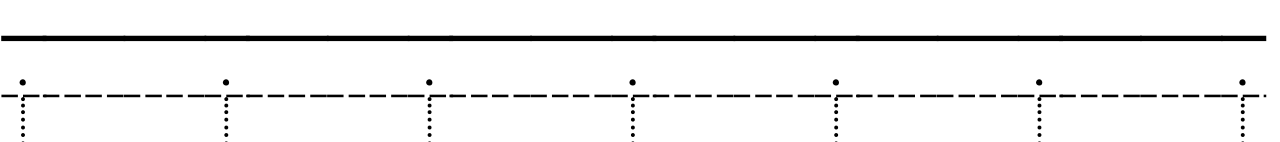
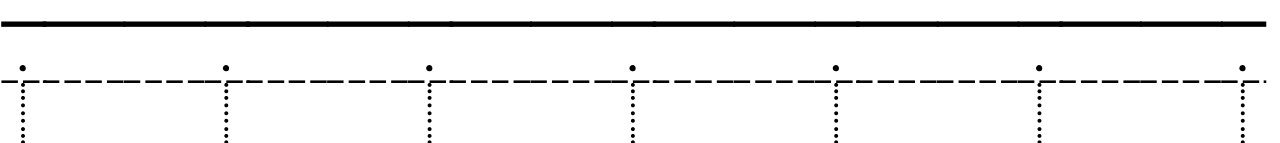
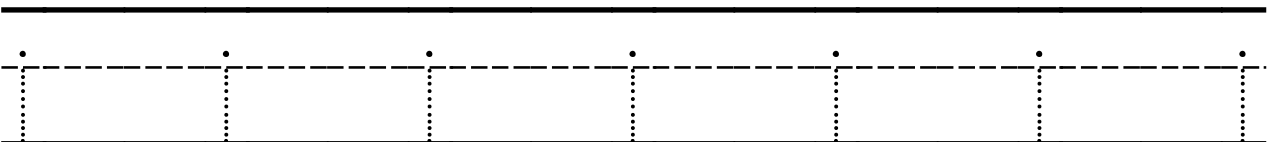
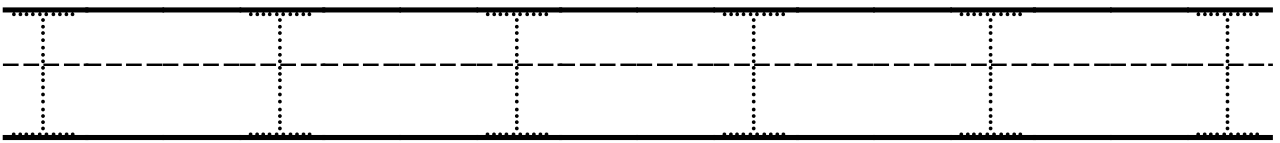
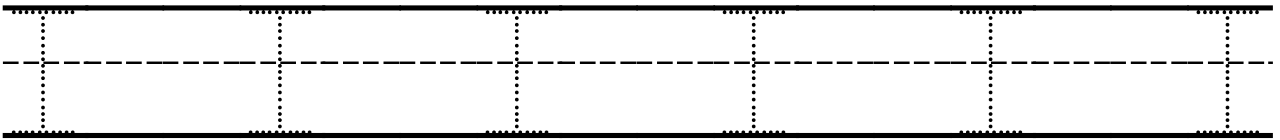
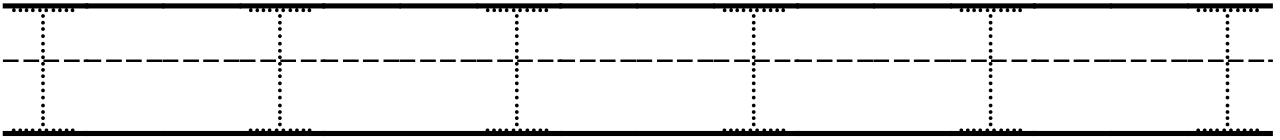
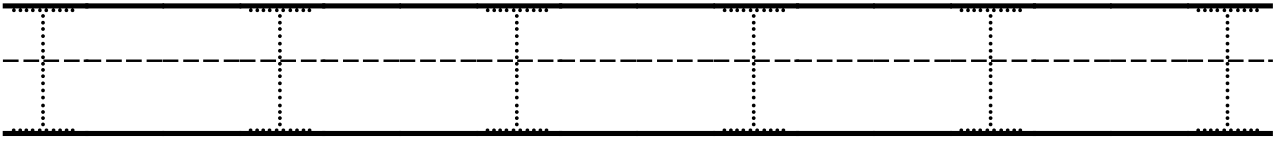

Nom \_\_\_\_\_ Date \_\_\_\_\_

Ecris la lettre l/i

**l l l l l**

\_\_\_\_\_

-----

\_\_\_\_\_

\_\_\_\_\_

-----

\_\_\_\_\_

**i i i i i**

\_\_\_\_\_

-----

\_\_\_\_\_

\_\_\_\_\_

-----

\_\_\_\_\_

Nom \_\_\_\_\_

Date \_\_\_\_\_

# Colorie la lettre I

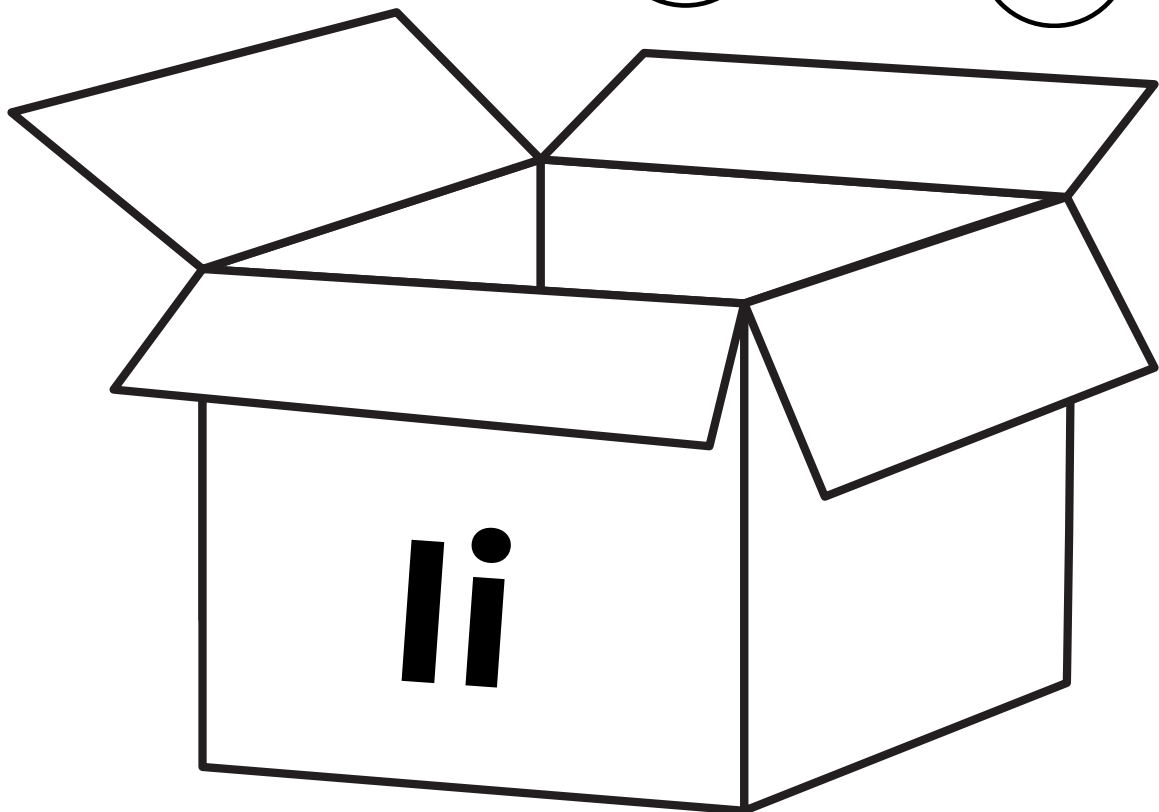
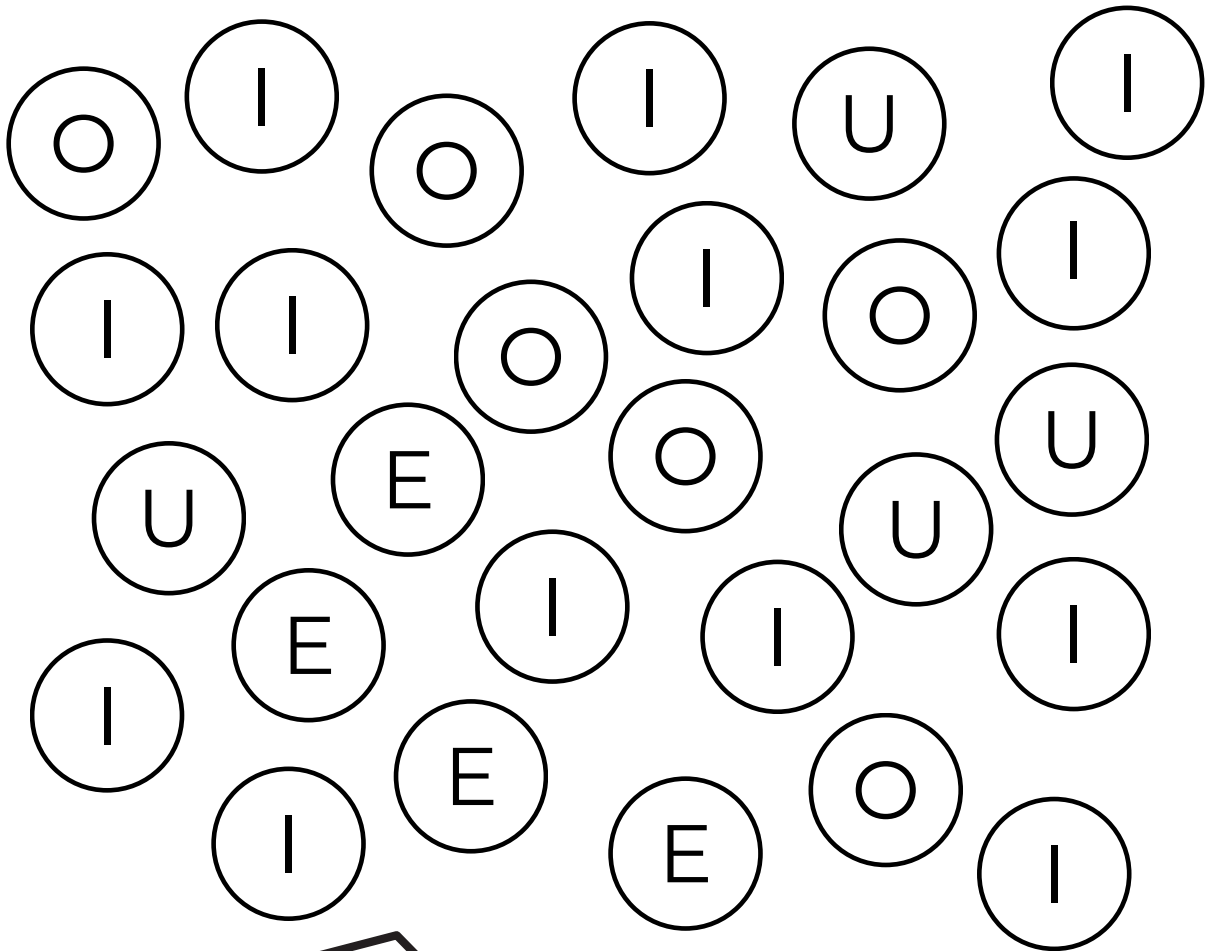

Nom \_\_\_\_\_

Date \_\_\_\_\_

## Colorie la lettre i

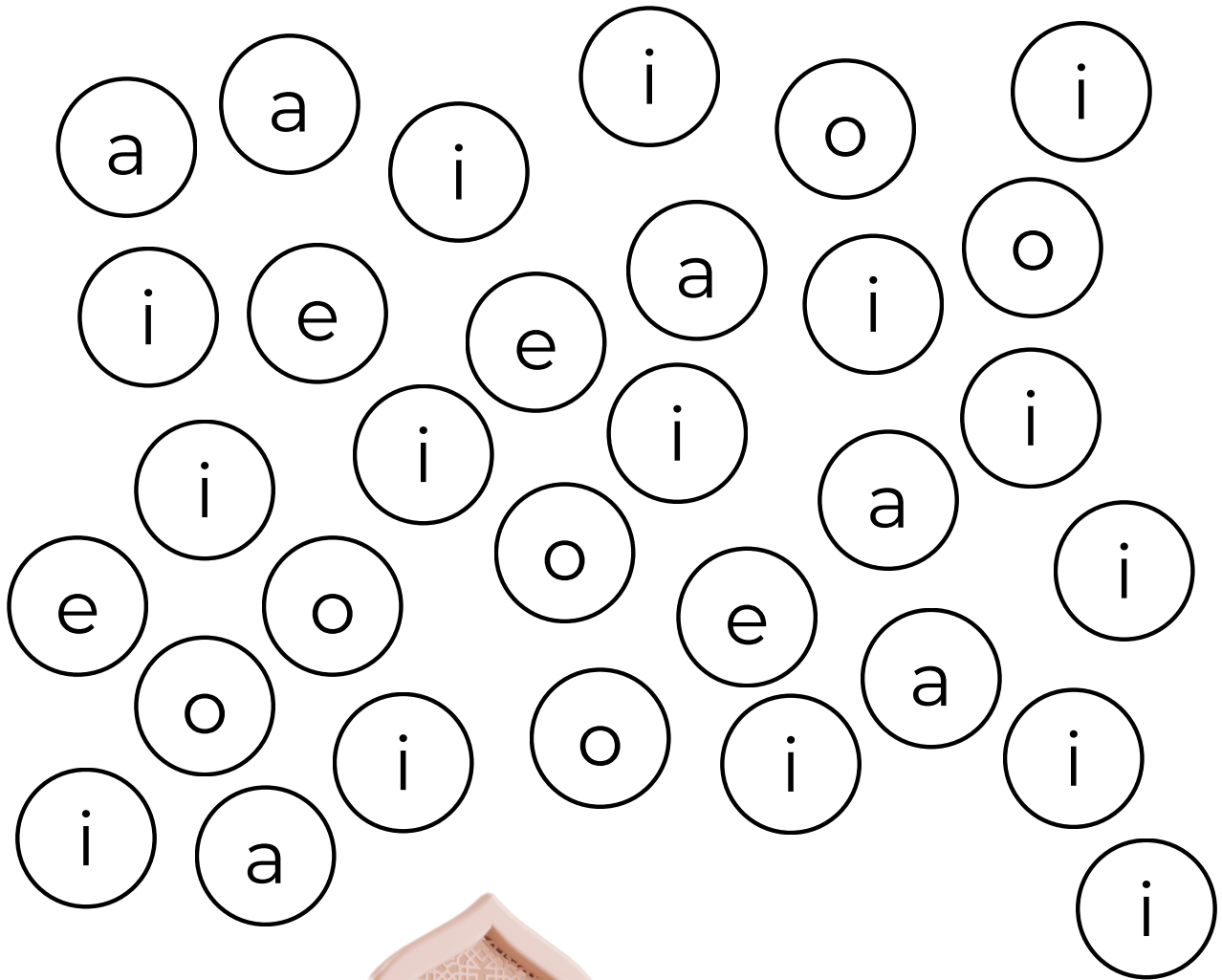

ISLAM / islam

Nom \_\_\_\_\_

Date \_\_\_\_\_

Repasse sur la lettre J / j

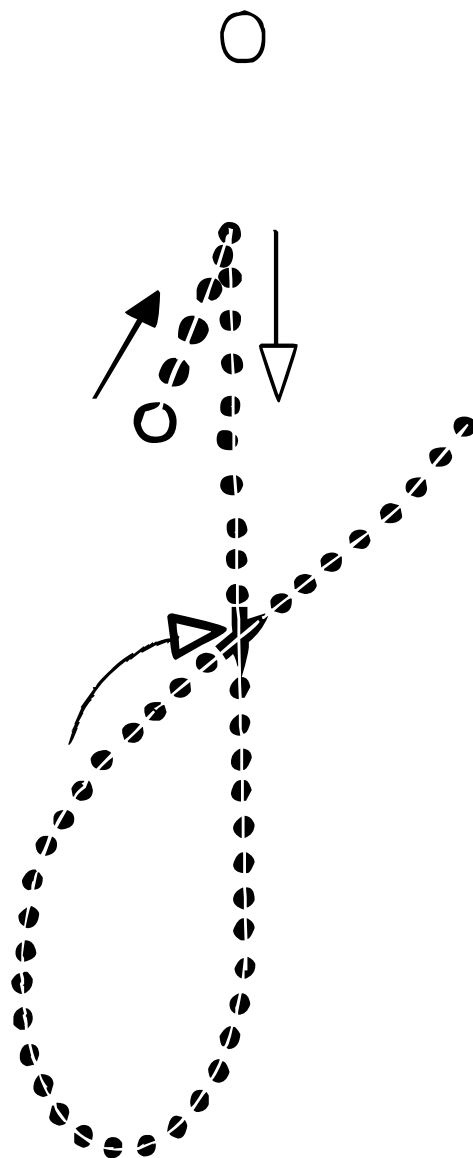

Nom \_\_\_\_\_

Date \_\_\_\_\_

Repasse sur la lettre J / j

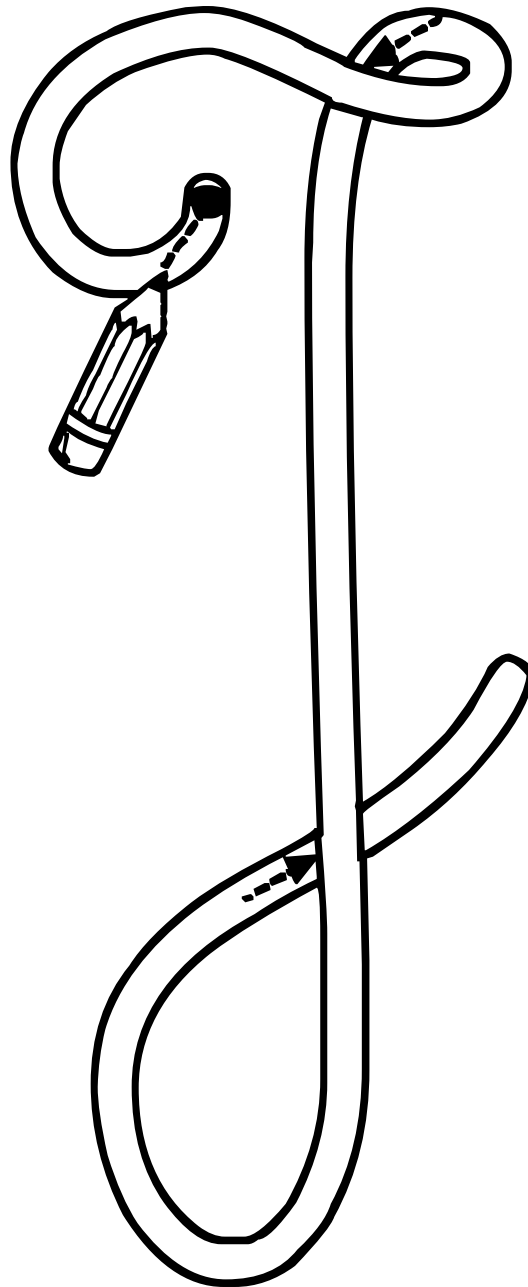

Nom \_\_\_\_\_

Date \_\_\_\_\_

Repasse sur la lettre J / j

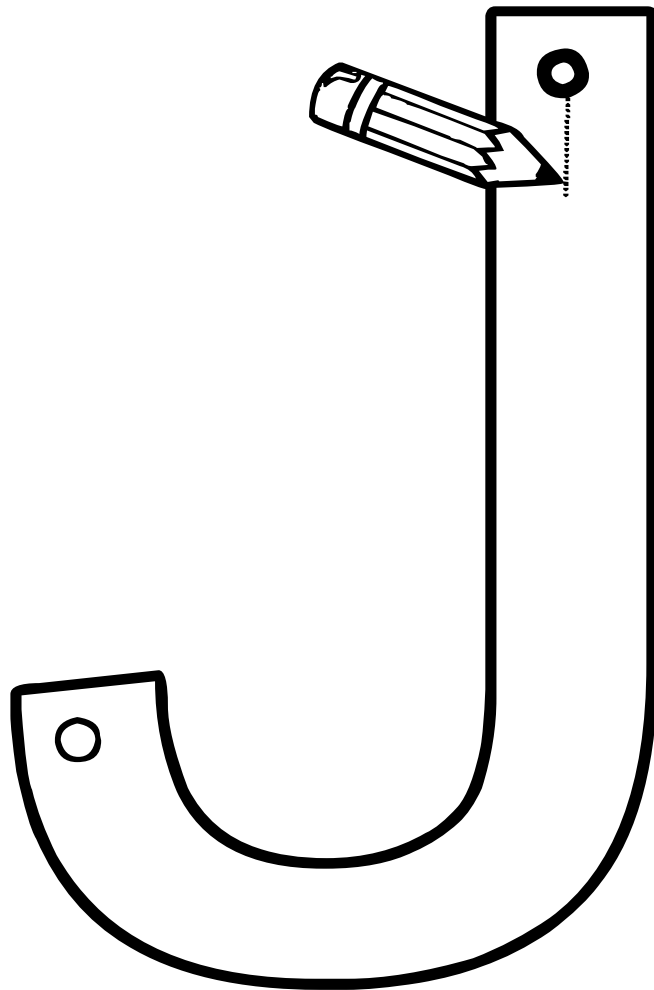

Nom \_\_\_\_\_

Date \_\_\_\_\_

# Ecris la lettre J / j

Handwriting practice sheet for the letter 'J / j'. The page contains eight rows of handwriting lines. Each row consists of a top line, a middle line, and a bottom line. In each row, there are eight dotted uppercase 'J' characters. Each 'J' has a small circle above it indicating the starting point and a small arrow pointing downwards and to the right, indicating the direction of the stroke. The characters are arranged in a grid for tracing practice.

Nom \_\_\_\_\_

Date \_\_\_\_\_

# Ecris la lettre J / j

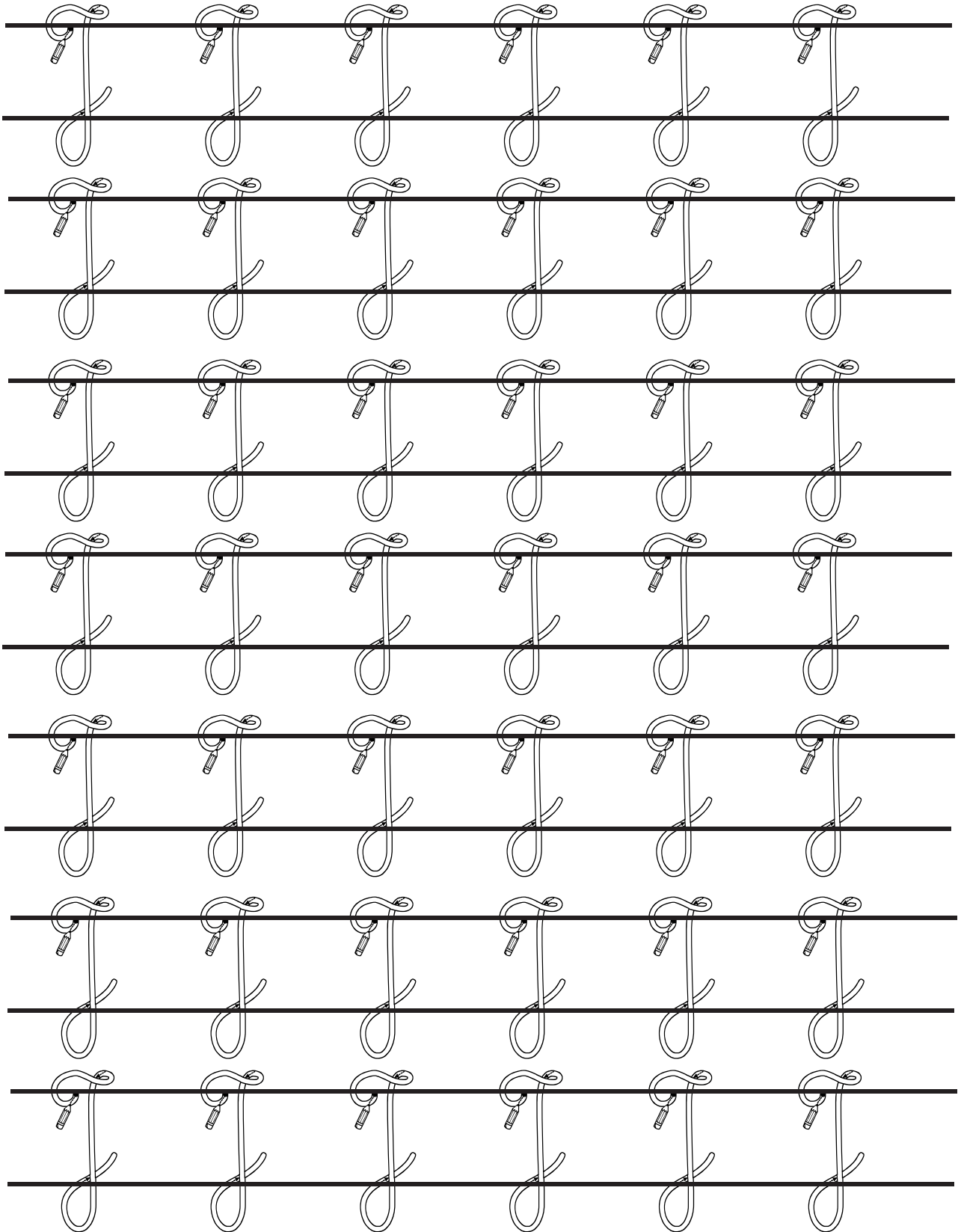

Nom \_\_\_\_\_

Date \_\_\_\_\_

## Ecris la lettre J/j

J J J J J

J J J J J

J J J J J

J J J J J

j j j j j j j

j j j j j j j

j j j j j j j

j j j j j j j

Nom \_\_\_\_\_ Date \_\_\_\_\_

Ecris la lettre J/j

J J J J J

Handwriting practice lines for uppercase letter J. The first row contains five uppercase 'J's. Below it are two sets of blank handwriting lines, each consisting of a solid top line, a dashed middle line, and a solid bottom line.

j j j j j

Handwriting practice lines for lowercase letter j. The first row contains five lowercase 'j's. Below it are two sets of blank handwriting lines, each consisting of a solid top line, a dashed middle line, and a solid bottom line.

Nom \_\_\_\_\_ Date \_\_\_\_\_

## Colorie la lettre J

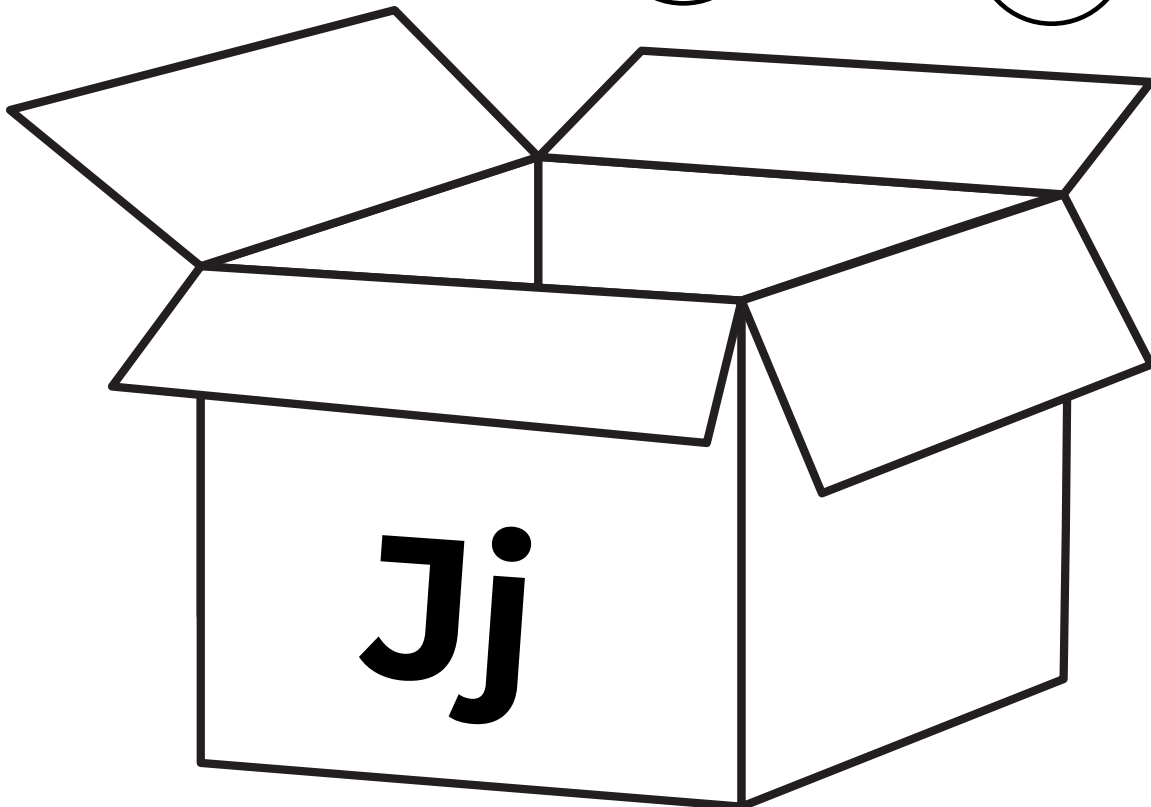
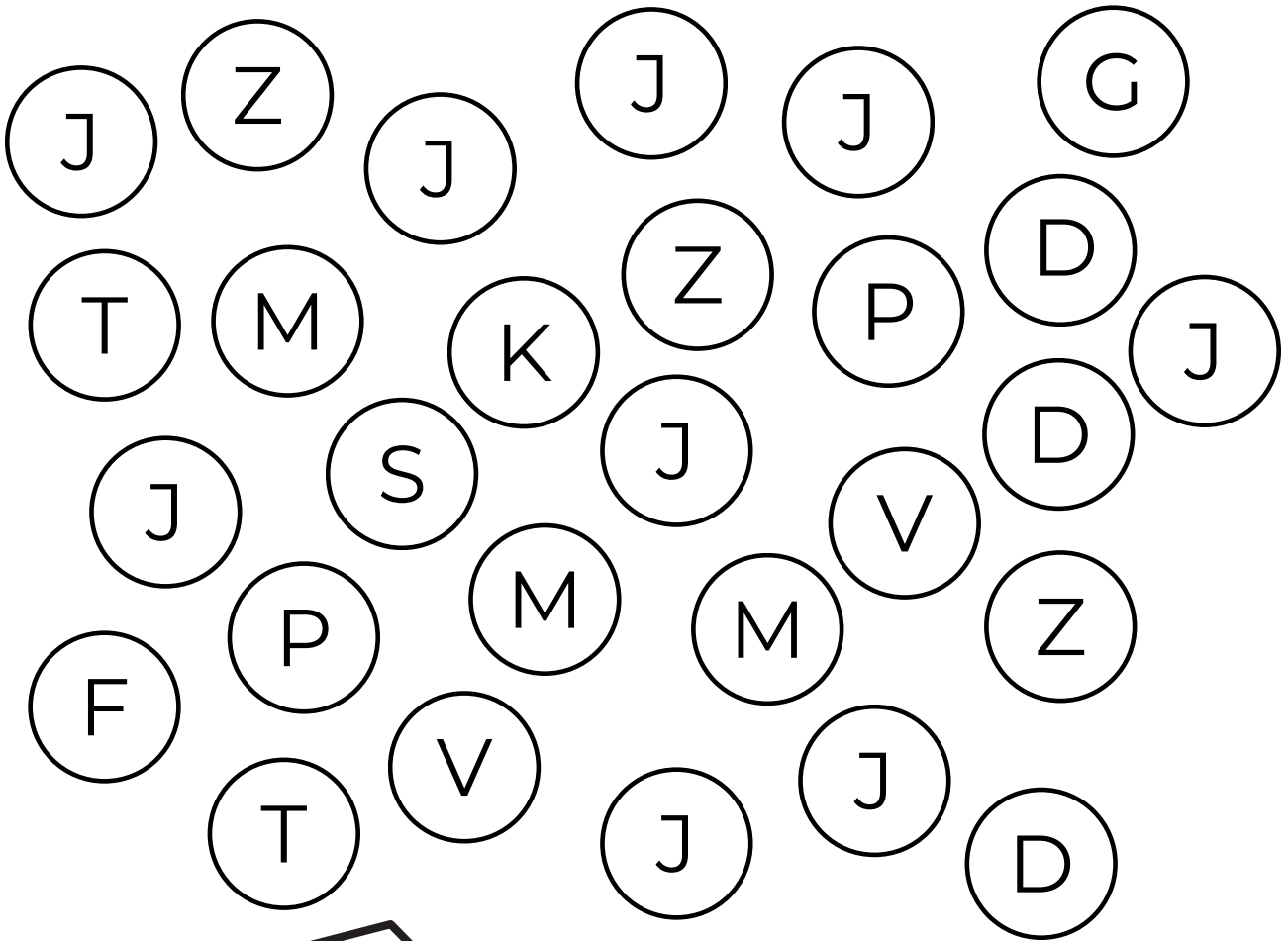

Nom \_\_\_\_\_

Date \_\_\_\_\_

## Colorie la lettre j

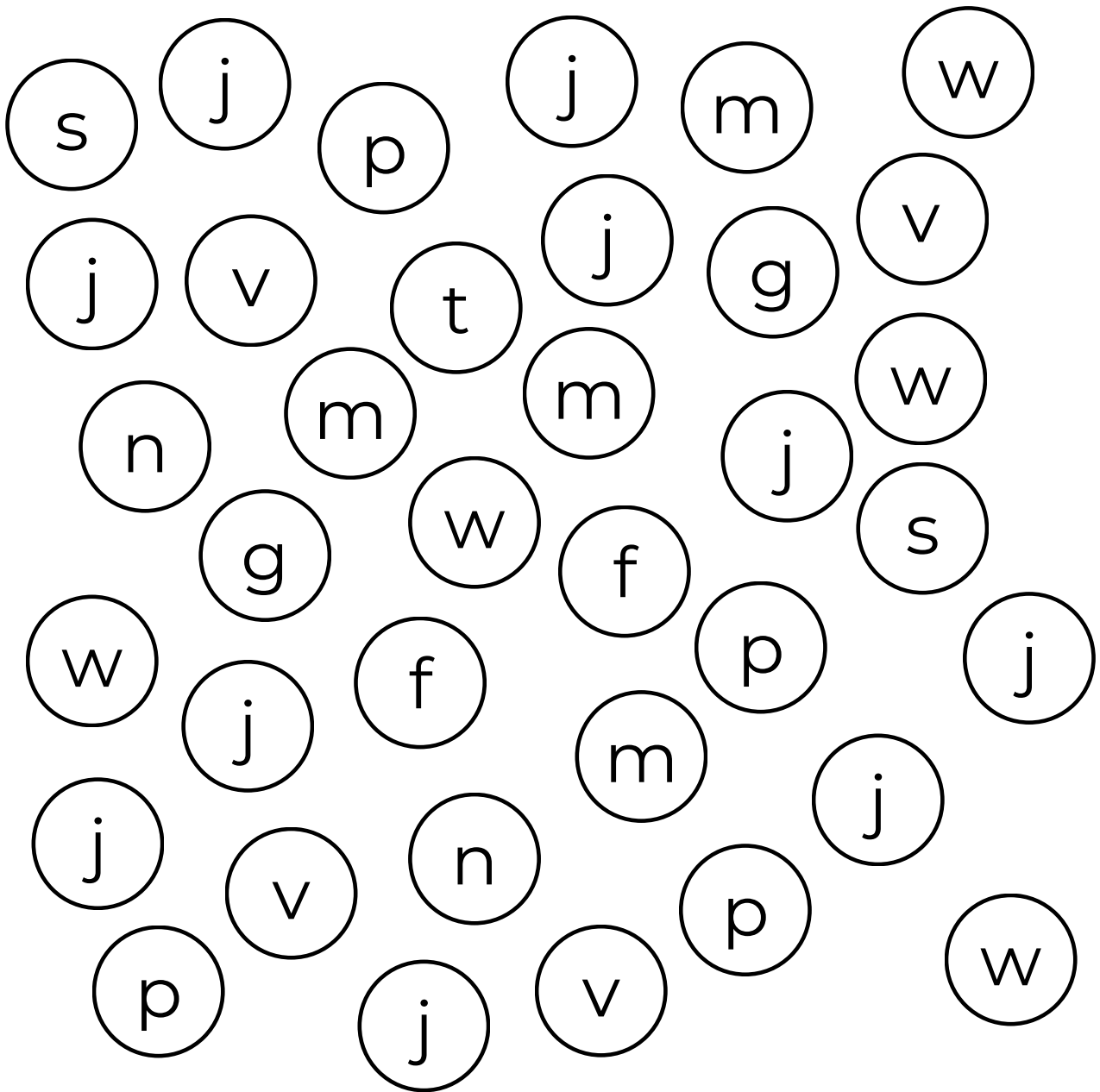

JARDIN / jardin



Nom \_\_\_\_\_

Date \_\_\_\_\_

Repasse sur la lettre K / k

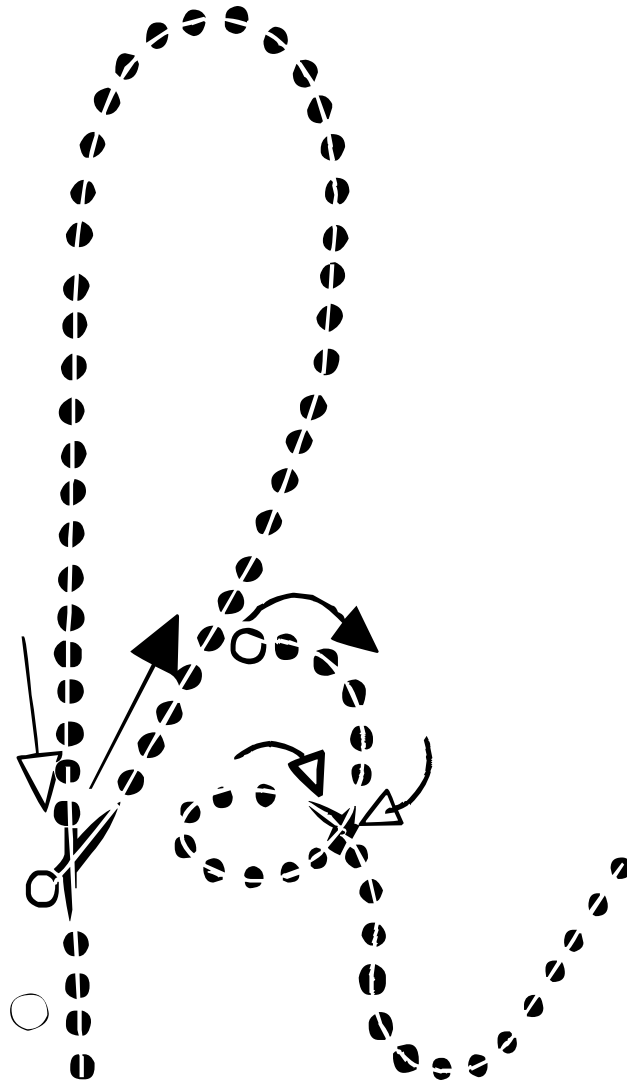

Nom \_\_\_\_\_

Date \_\_\_\_\_

Repasse sur la lettre K / k

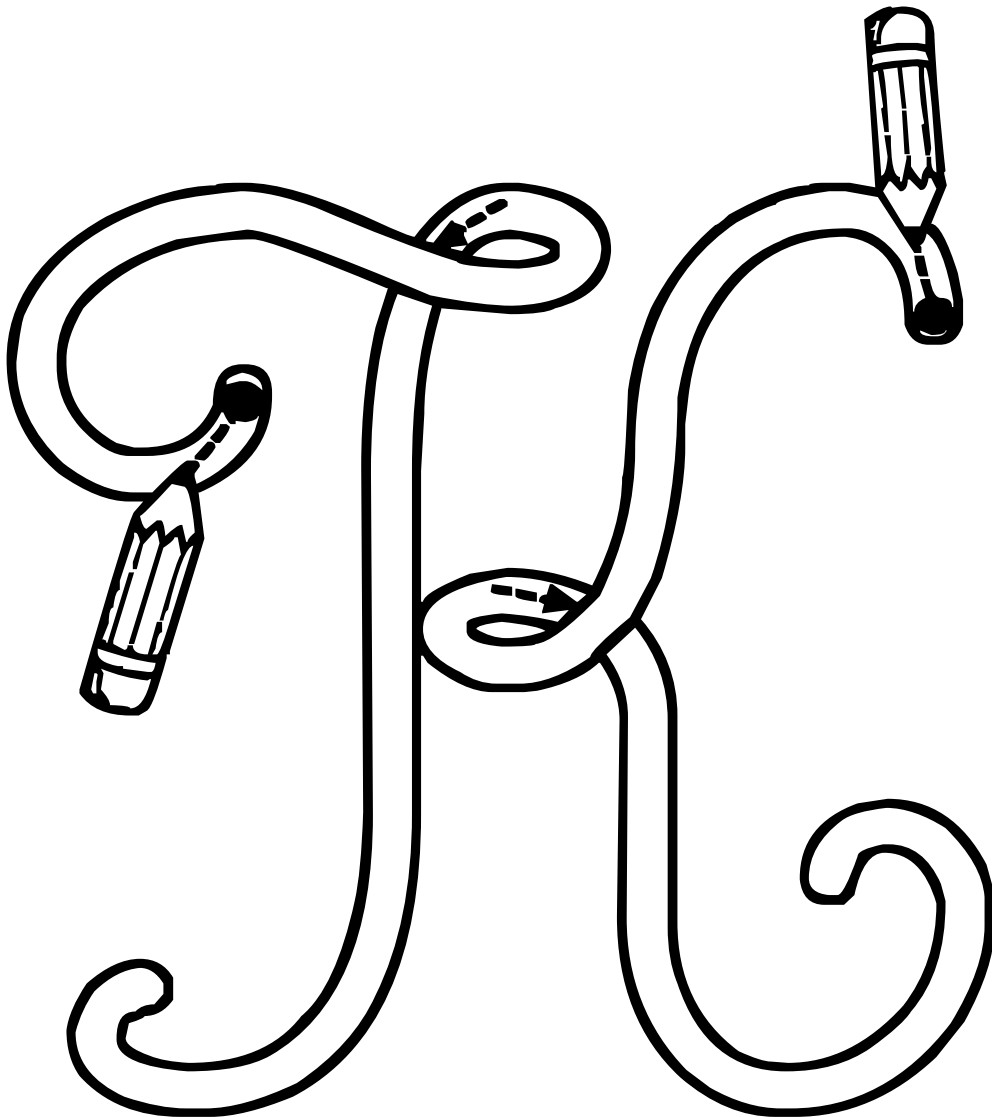

Nom \_\_\_\_\_

Date \_\_\_\_\_

Repasse sur la lettre K / k

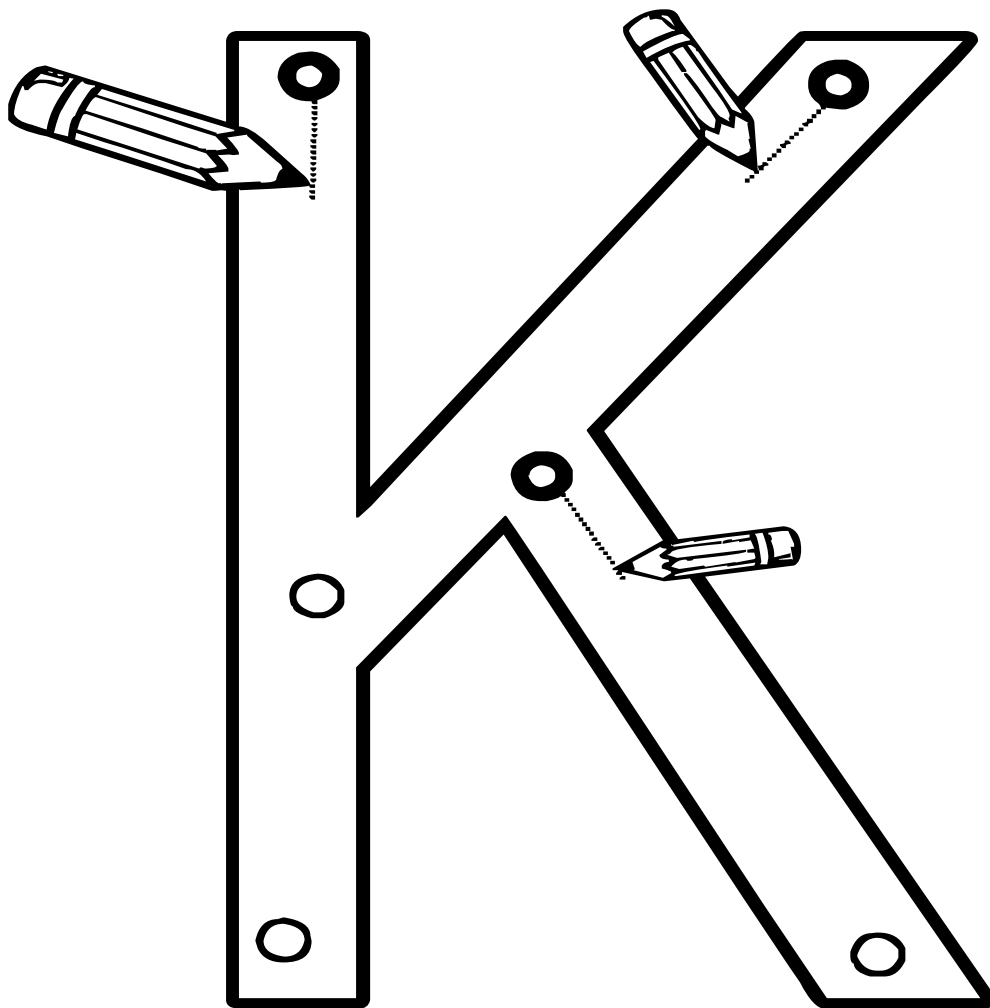

Nom \_\_\_\_\_

Date \_\_\_\_\_

# Ecris la lettre K / k

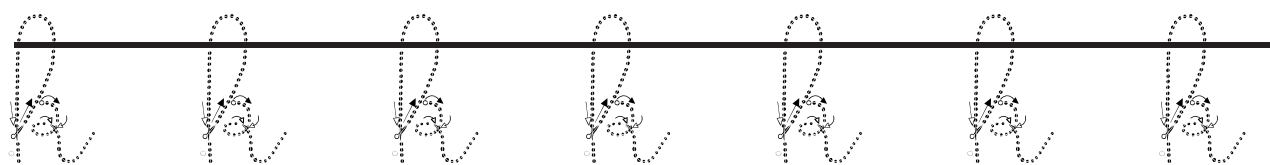
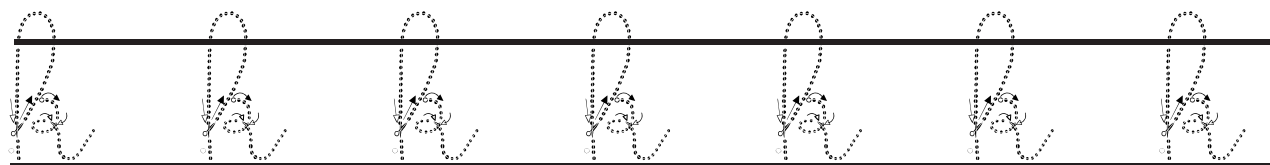
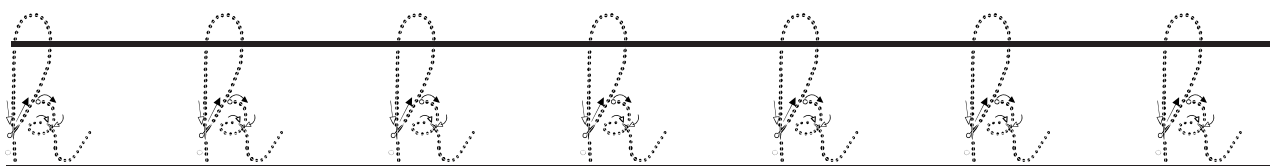
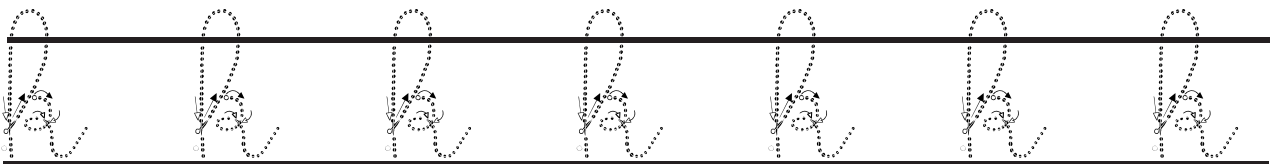
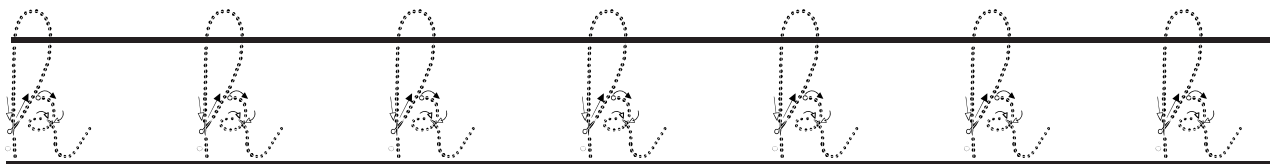
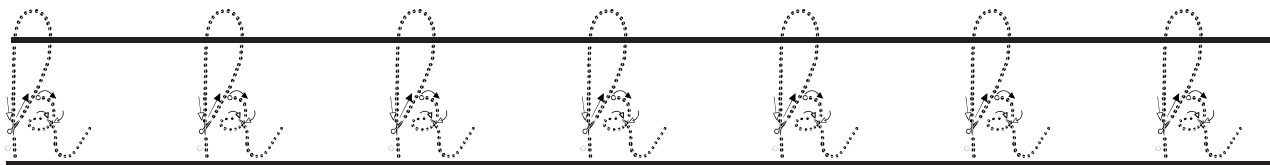
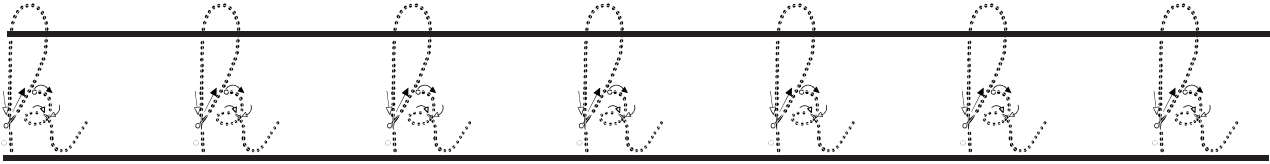

Nom \_\_\_\_\_

Date \_\_\_\_\_

# Ecris la lettre K / k

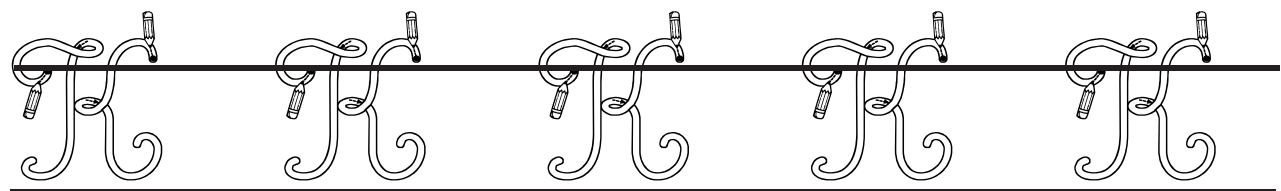
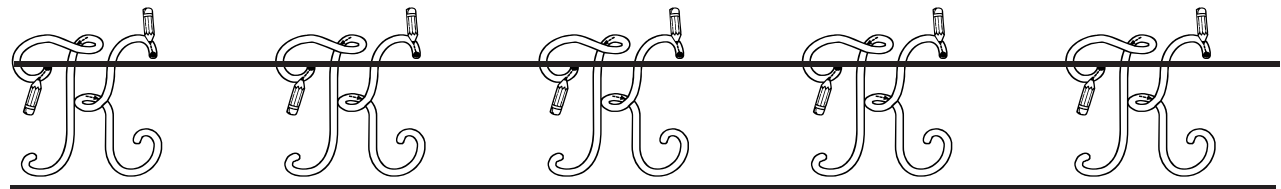
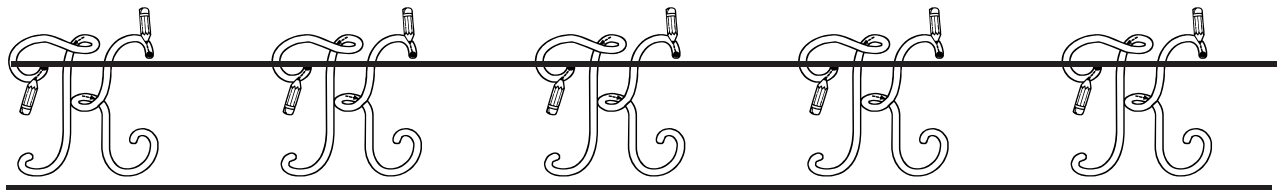
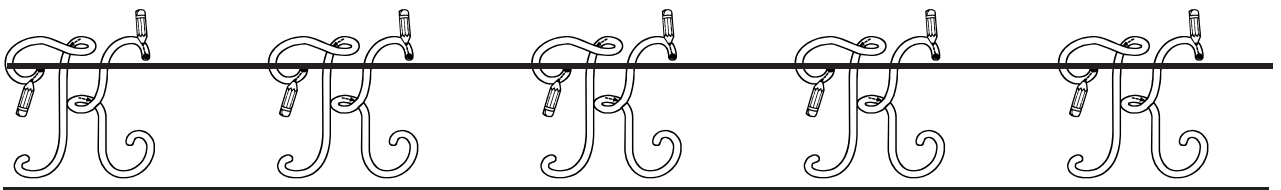
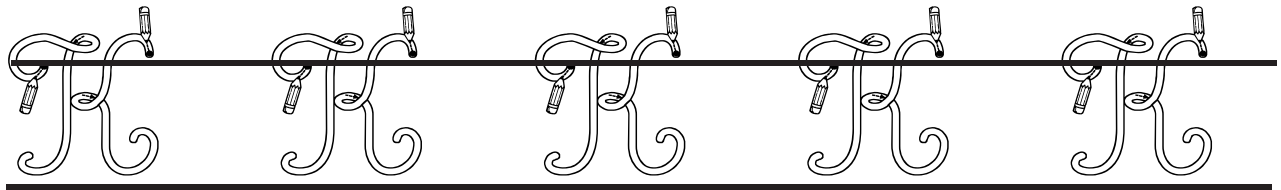
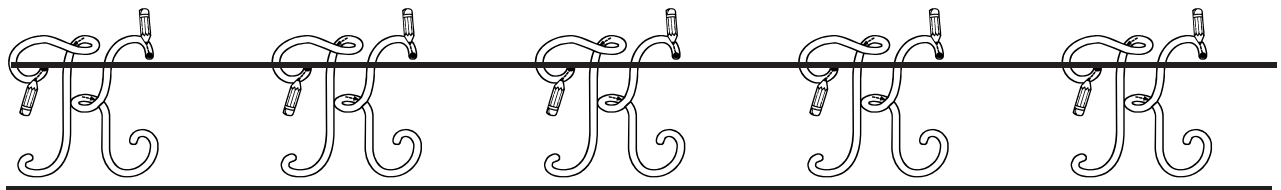
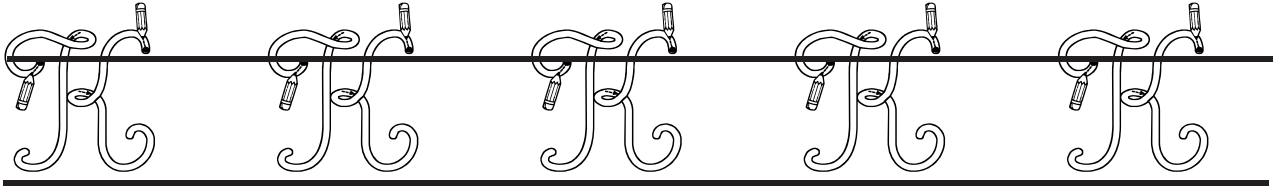

Nom \_\_\_\_\_ Date \_\_\_\_\_

# Ecris la lettre K/k

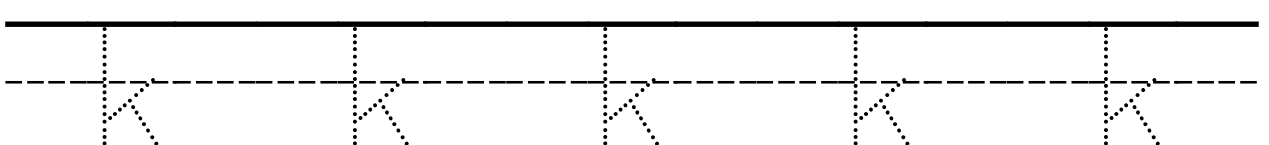
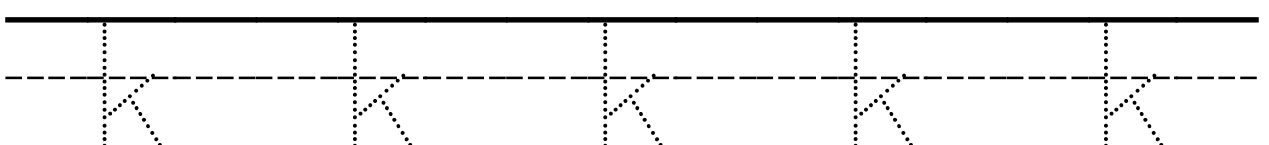
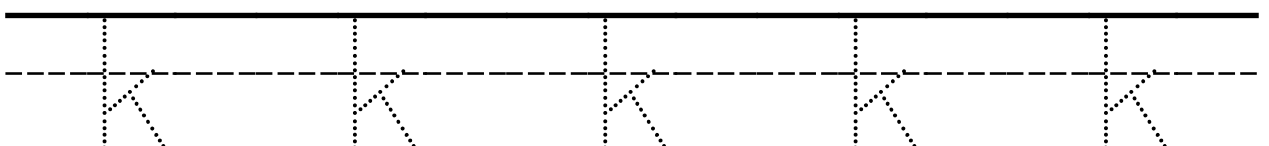
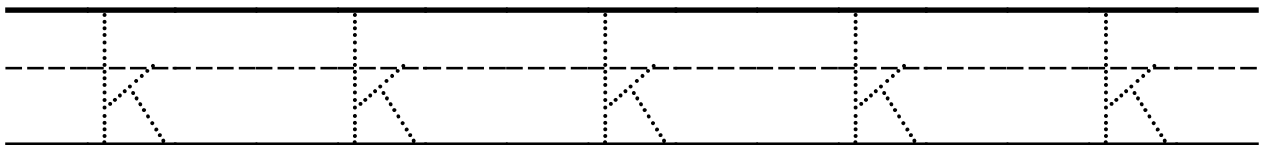
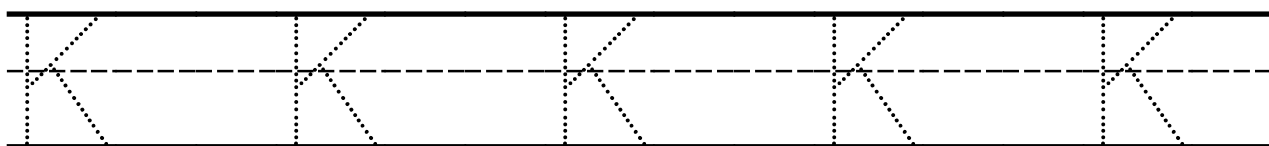
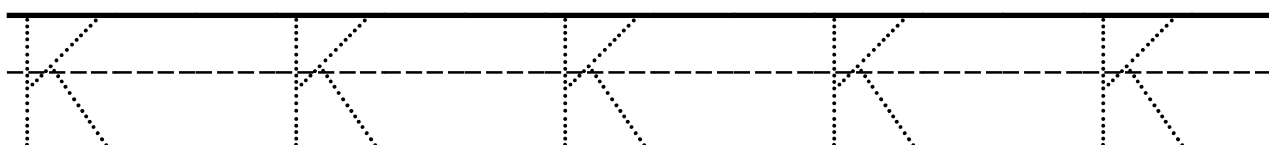
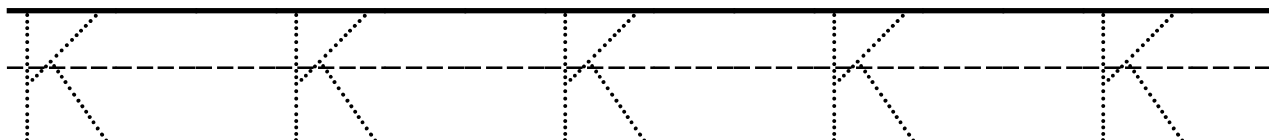
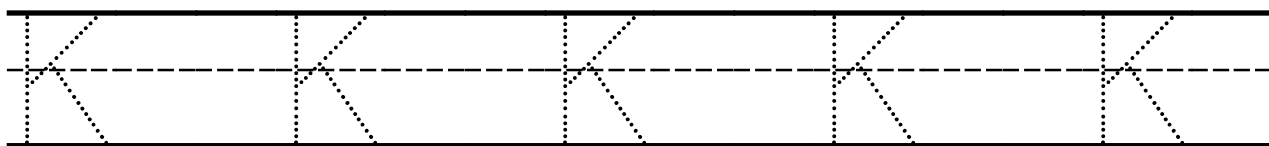

Nom \_\_\_\_\_ Date \_\_\_\_\_

Ecris la lettre K/k

K K K K K

Handwriting practice lines for uppercase letter K. Each row consists of a solid top line, a dashed middle line, and a solid bottom line. There are two such rows provided for practice.

k k k k k

Handwriting practice lines for lowercase letter k. Each row consists of a solid top line, a dashed middle line, and a solid bottom line. There are two such rows provided for practice.

Nom \_\_\_\_\_

Date \_\_\_\_\_

Colorie la lettre K

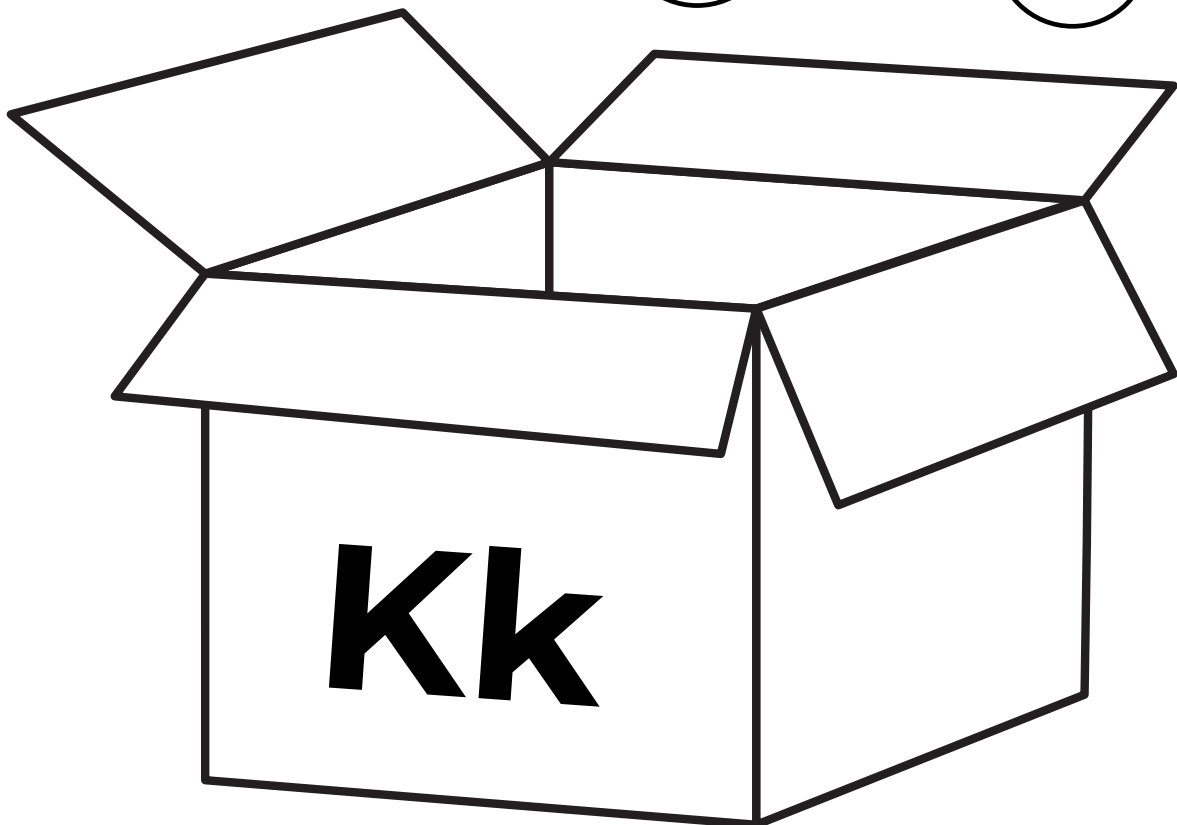
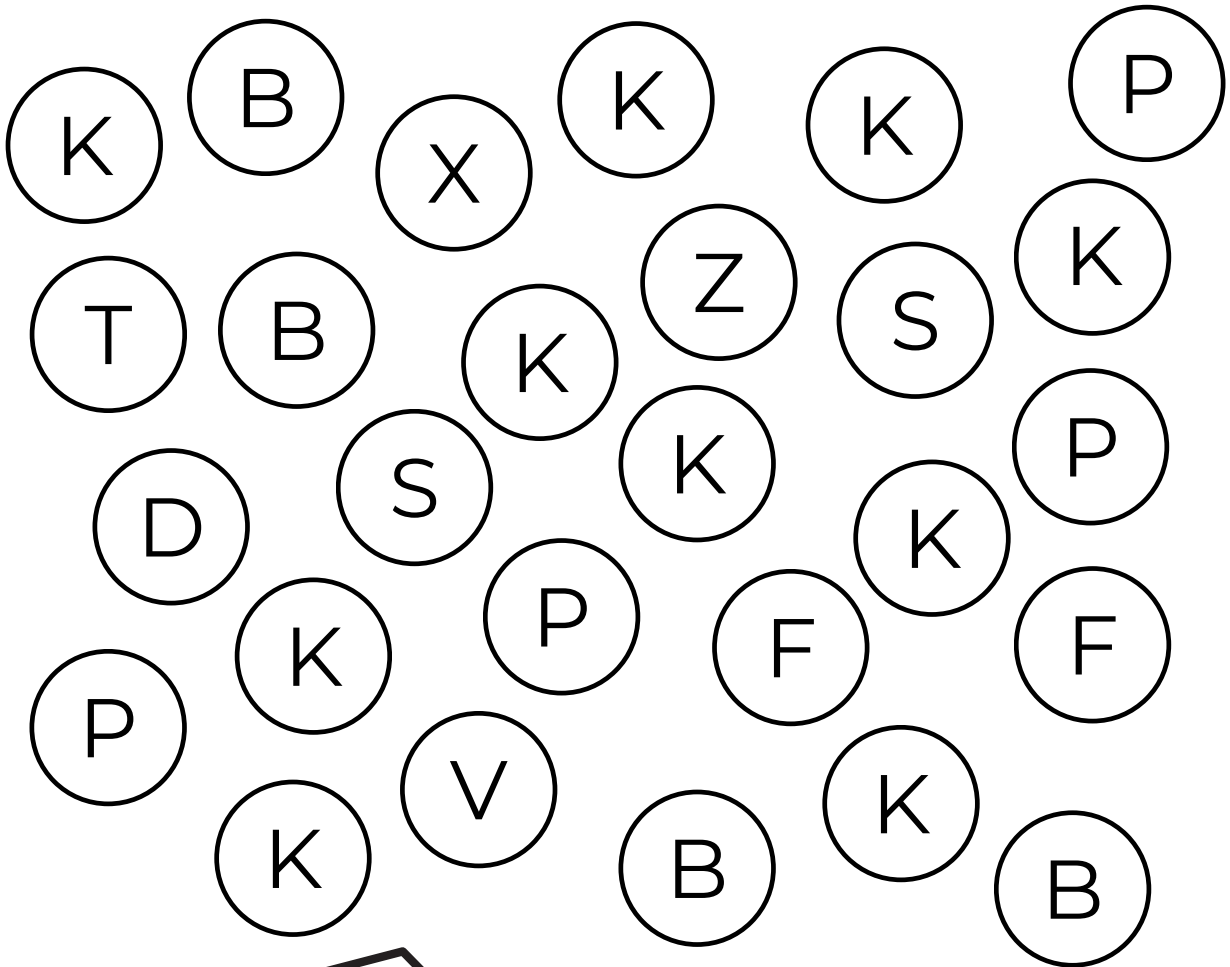

Nom \_\_\_\_\_

Date \_\_\_\_\_

## Colorie la lettre k

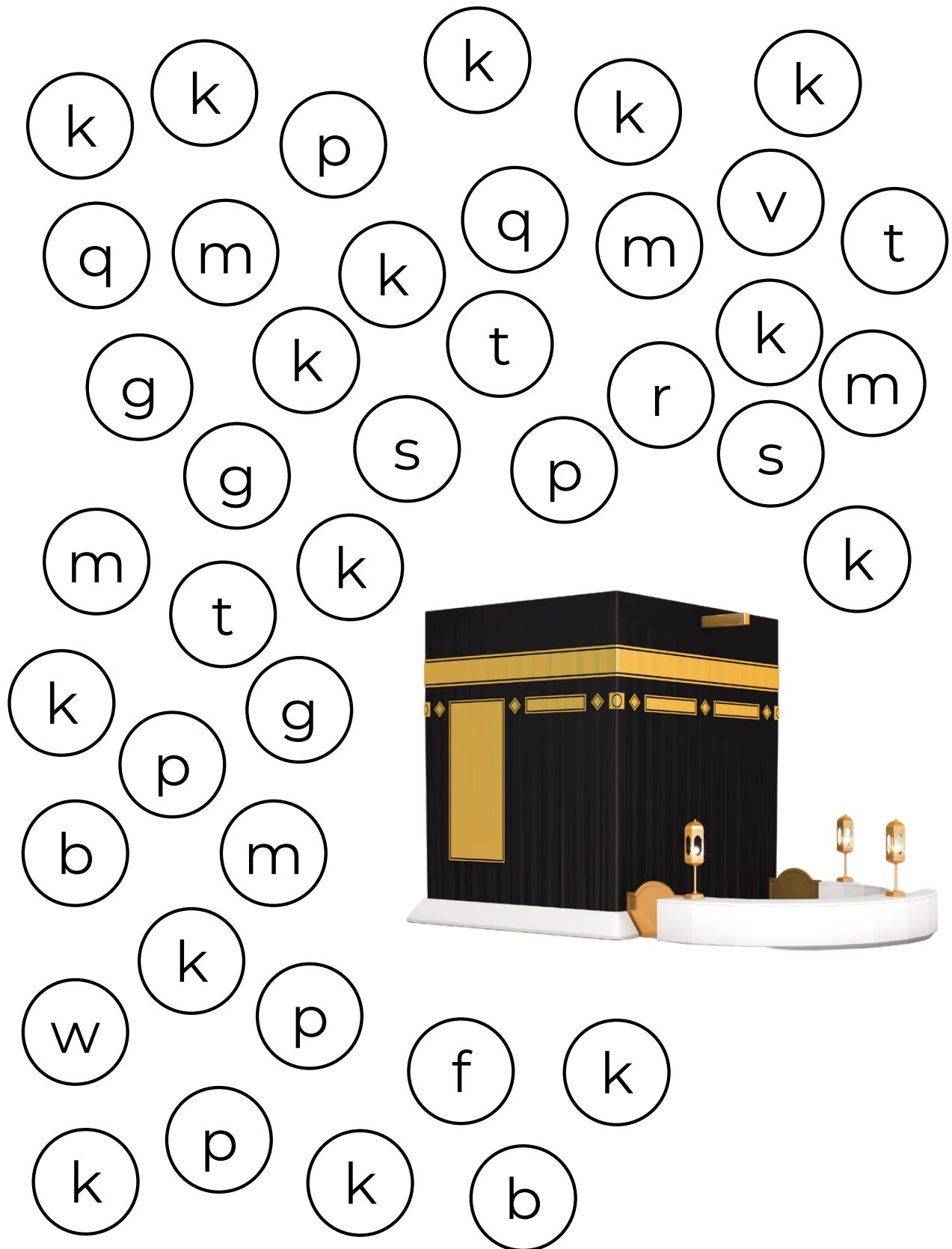

KAABA / kaaba

Nom \_\_\_\_\_

Date \_\_\_\_\_

Repasse sur la lettre L / l

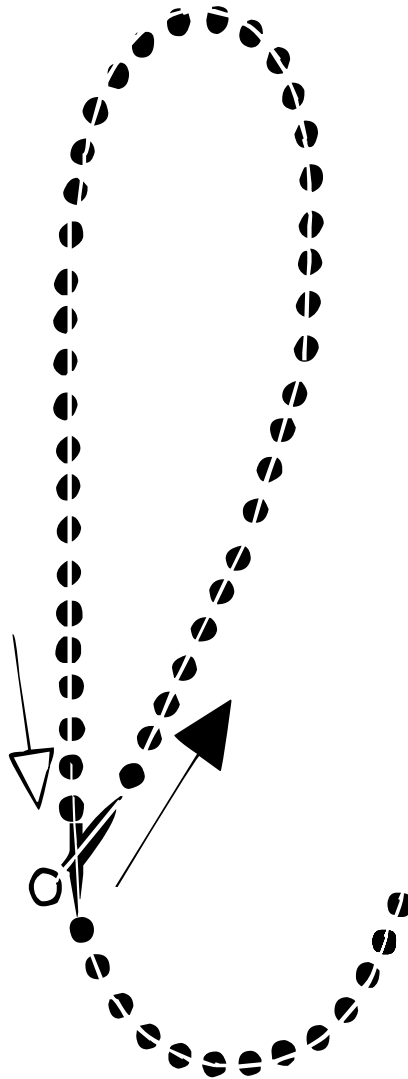

Nom \_\_\_\_\_

Date \_\_\_\_\_

Repasse sur la lettre L / l

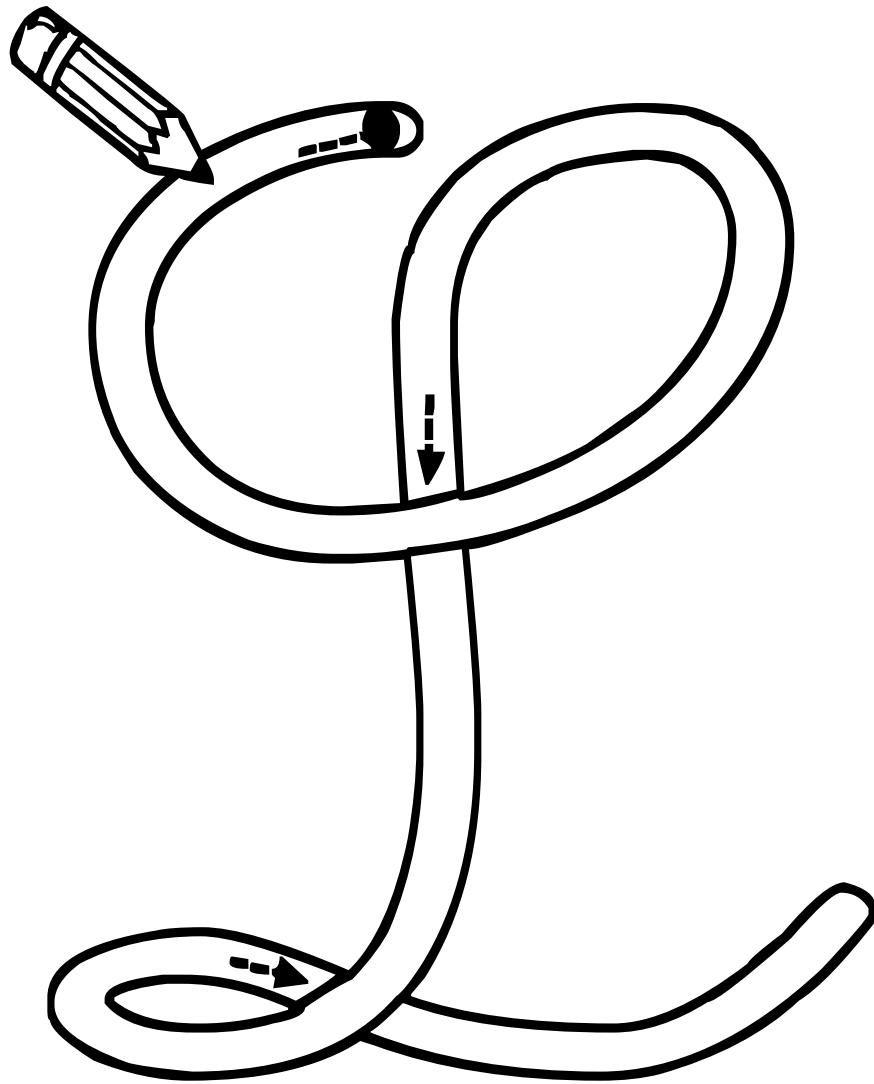

Nom \_\_\_\_\_

Date \_\_\_\_\_

Repasse sur la lettre L / l

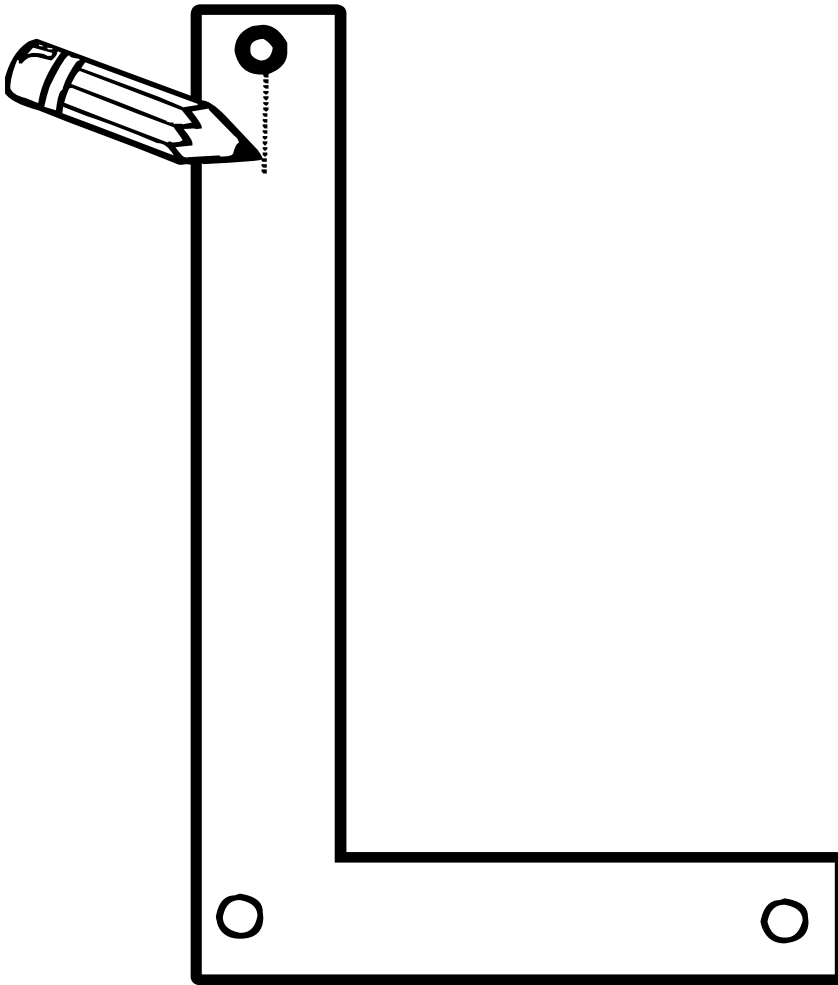

Nom \_\_\_\_\_

Date \_\_\_\_\_

## Ecris la lettre L / l

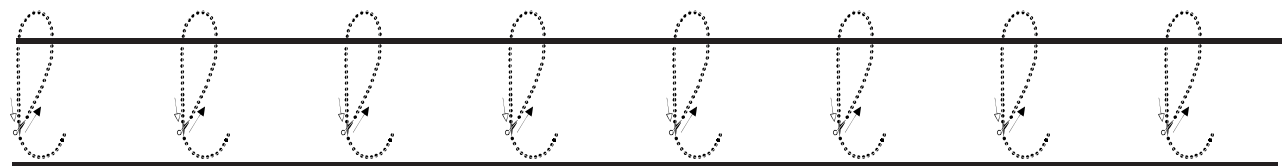
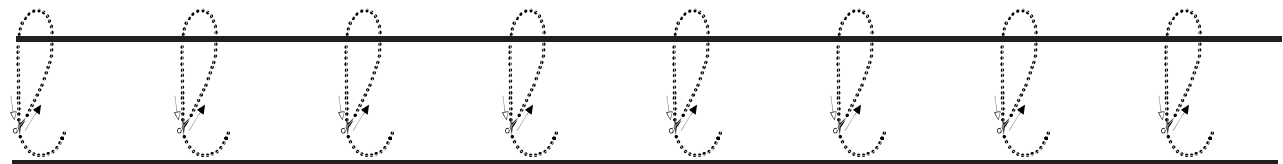
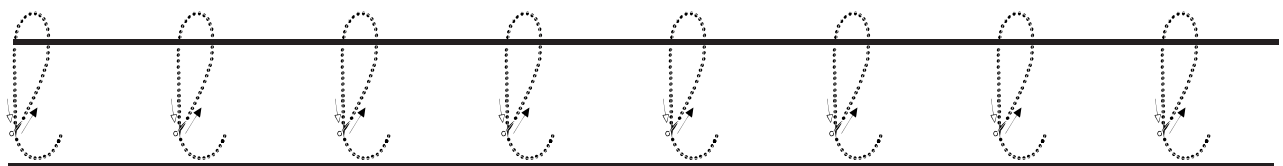
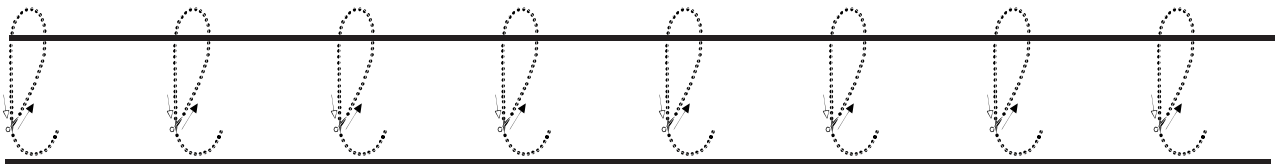
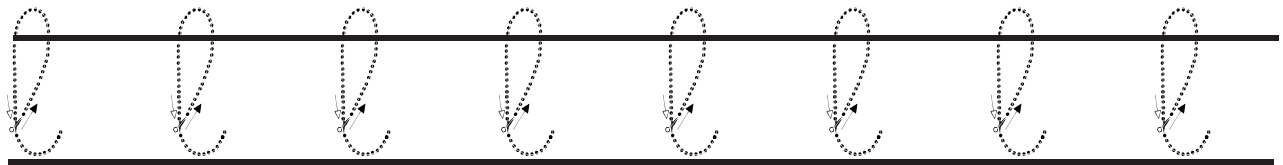
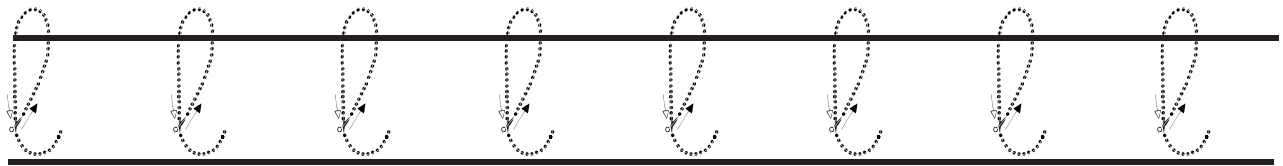
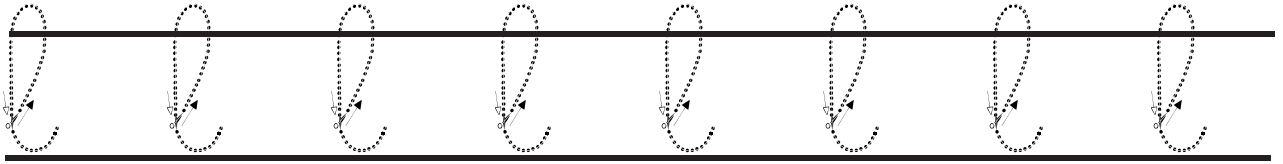

Nom \_\_\_\_\_

Date \_\_\_\_\_

# Ecris la lettre L / l

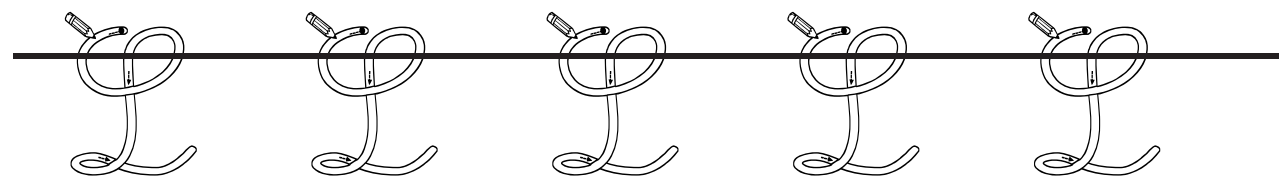
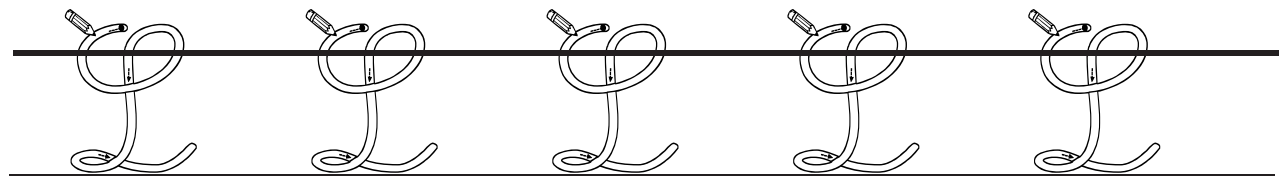
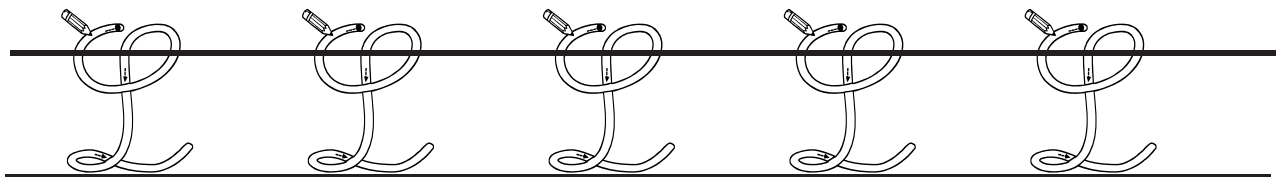
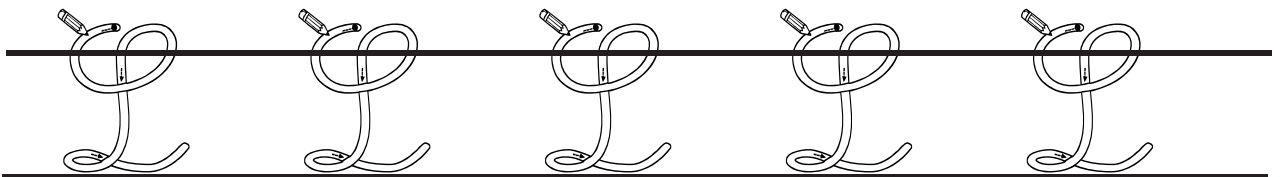
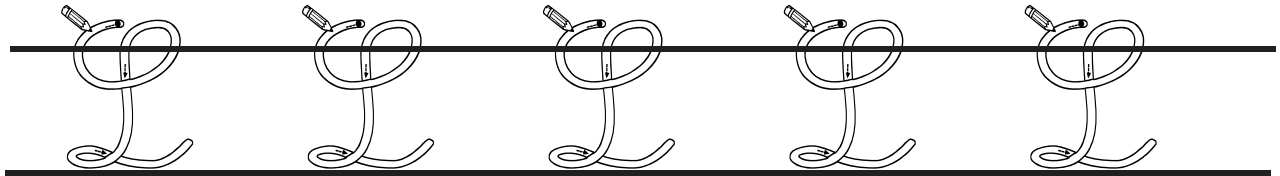
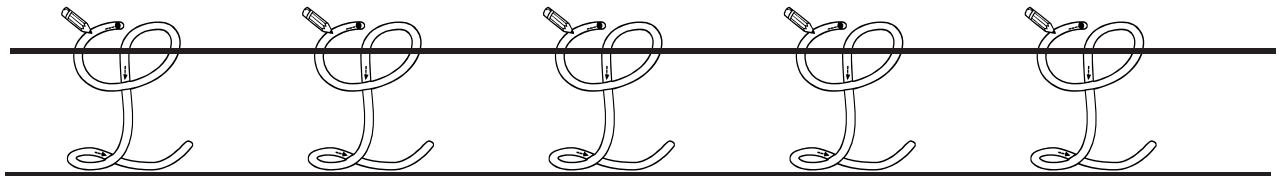
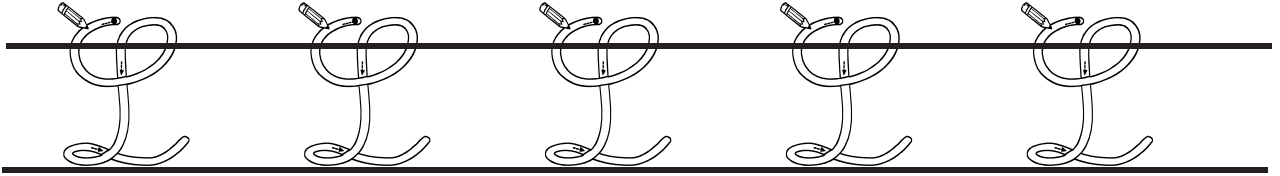

Nom \_\_\_\_\_ Date \_\_\_\_\_

# Ecris la lettre L/l

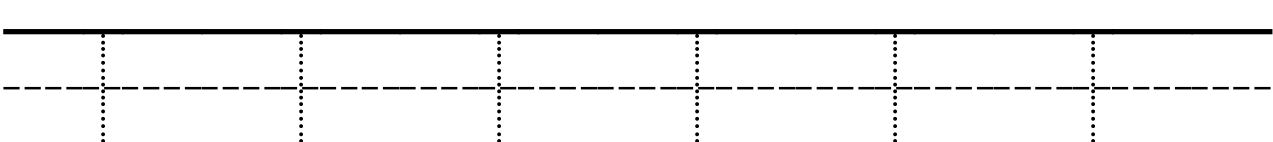
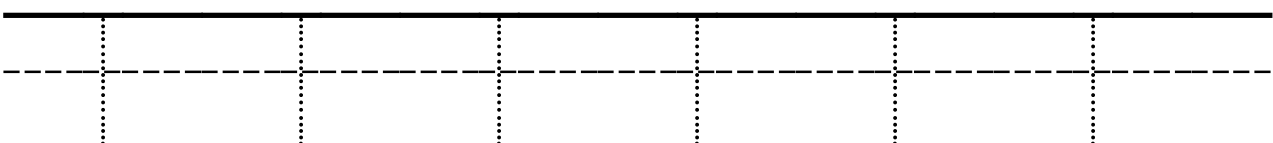
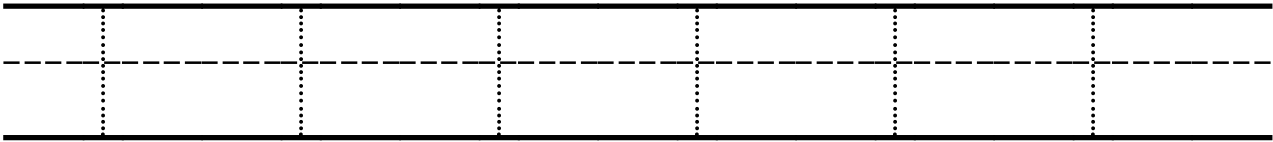
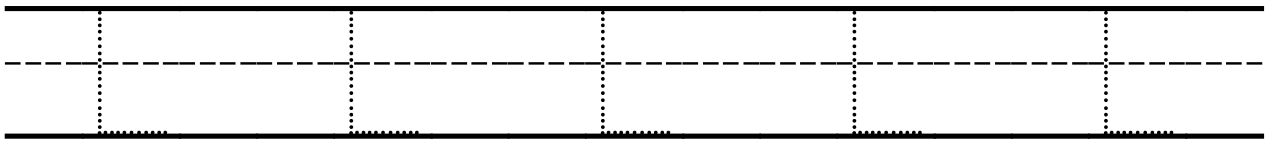
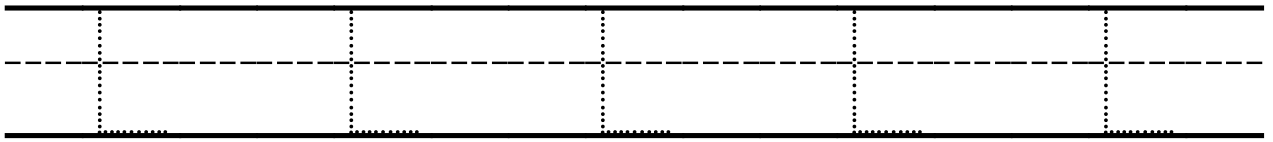
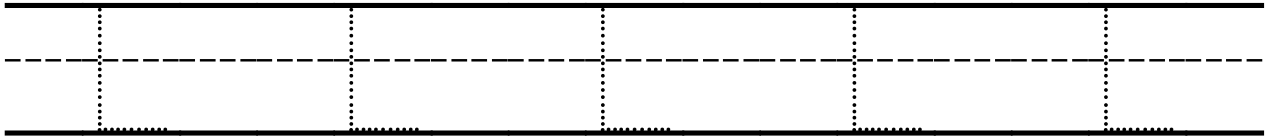
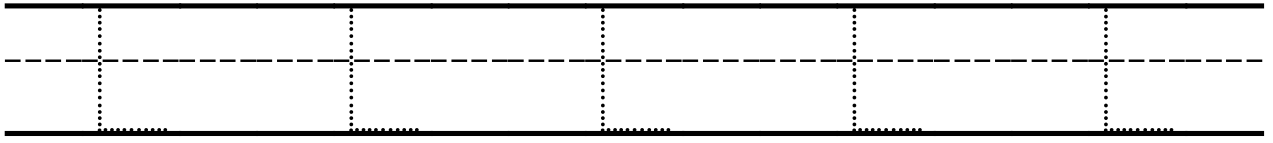

Nom \_\_\_\_\_ Date \_\_\_\_\_

Ecris la lettre L/l

L L L L L

Handwriting practice lines for uppercase letter L. The first row contains five uppercase 'L' characters. Below it are two sets of handwriting lines, each consisting of a solid top line, a dashed middle line, and a solid bottom line.

l l l l l

Handwriting practice lines for lowercase letter l. The first row contains five lowercase 'l' characters. Below it are two sets of handwriting lines, each consisting of a solid top line, a dashed middle line, and a solid bottom line.

Nom \_\_\_\_\_ Date \_\_\_\_\_

# Colorie la lettre L

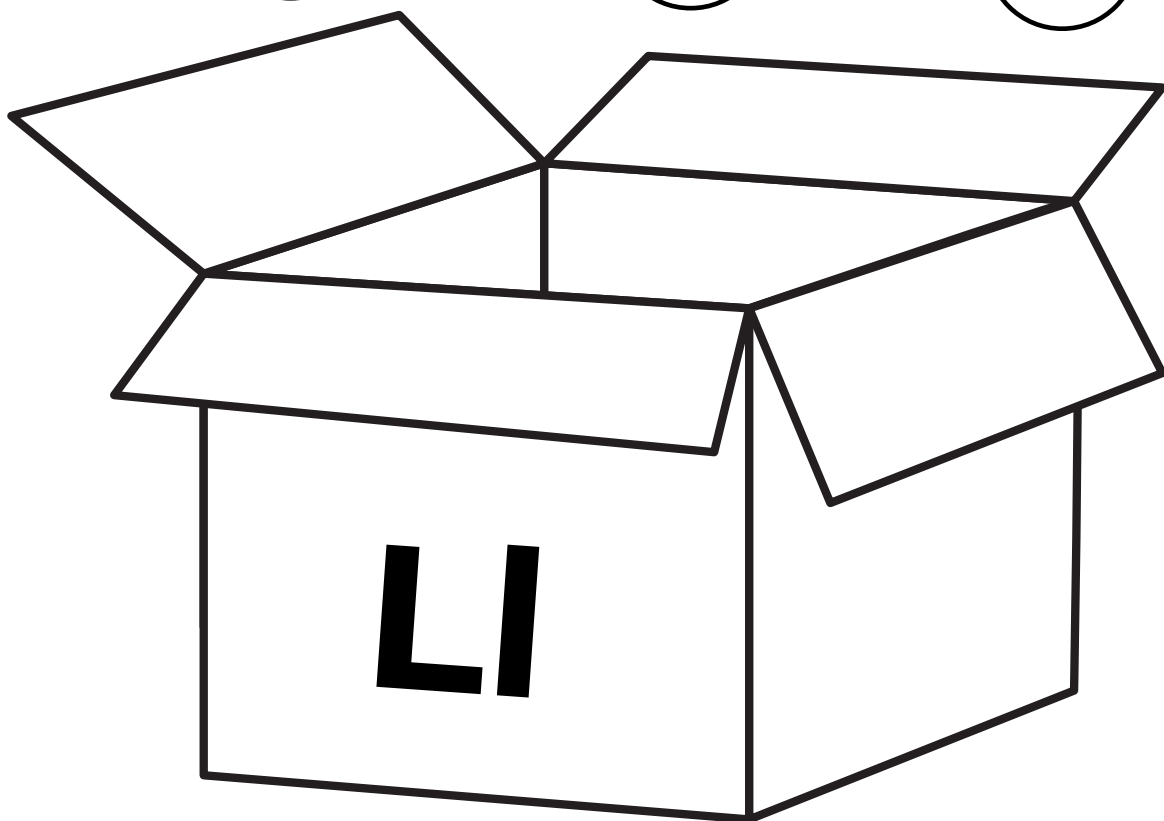
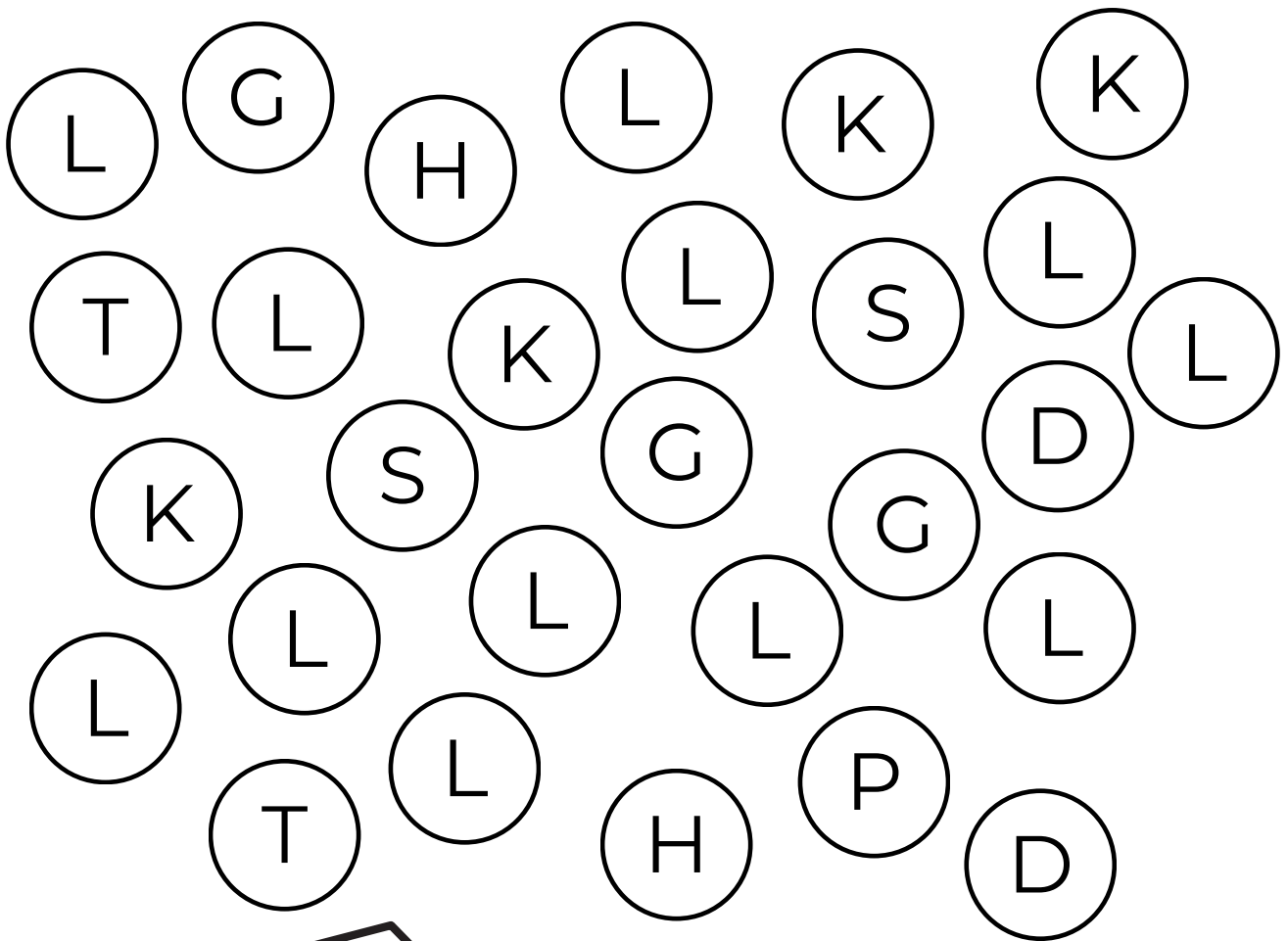

Nom \_\_\_\_\_

Date \_\_\_\_\_

## Colorie la lettre l

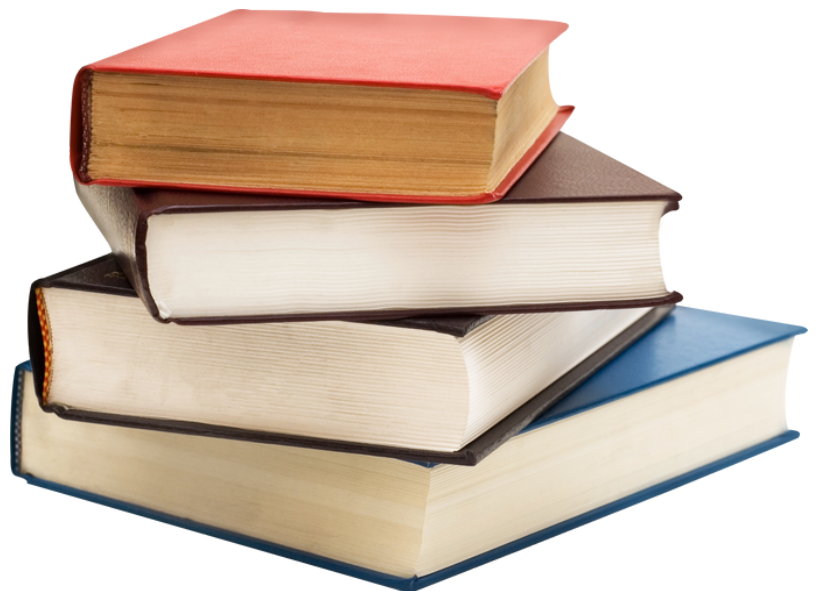
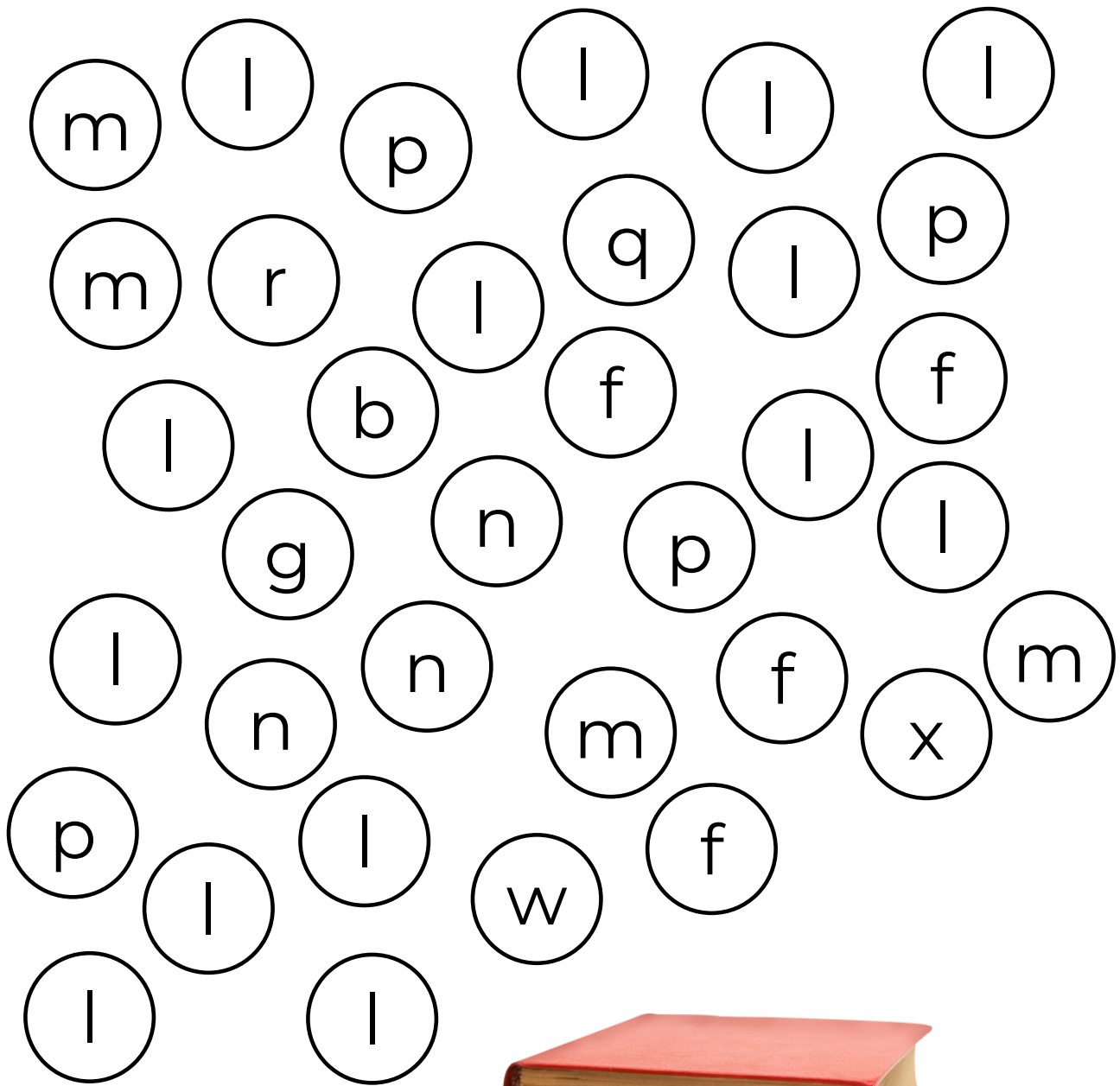

LIVRE / livre

Nom \_\_\_\_\_

Date \_\_\_\_\_

Repasse sur la lettre M / m

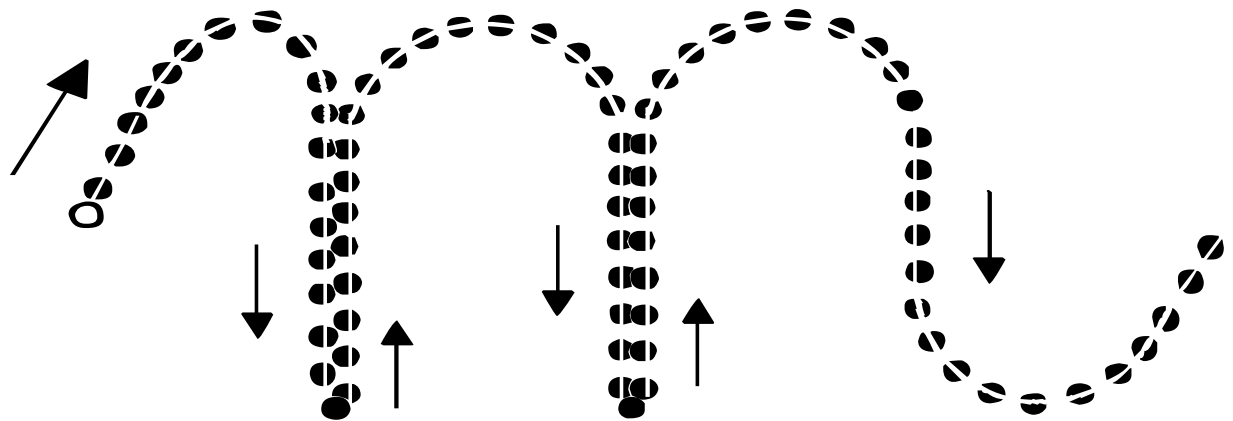

Nom \_\_\_\_\_

Date \_\_\_\_\_

Repasse sur la lettre M / m

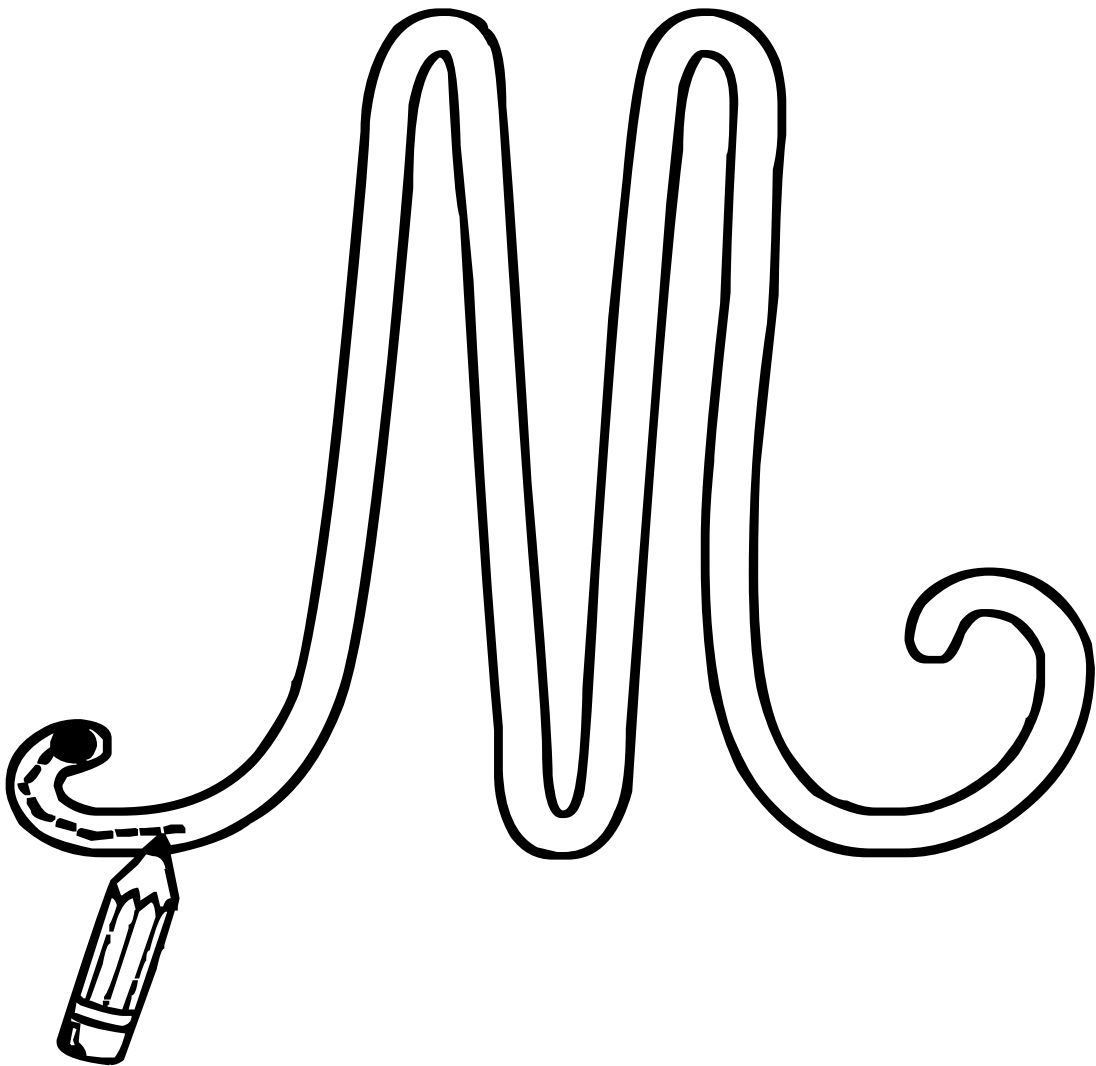

Nom \_\_\_\_\_

Date \_\_\_\_\_

Repasse sur la lettre M / m

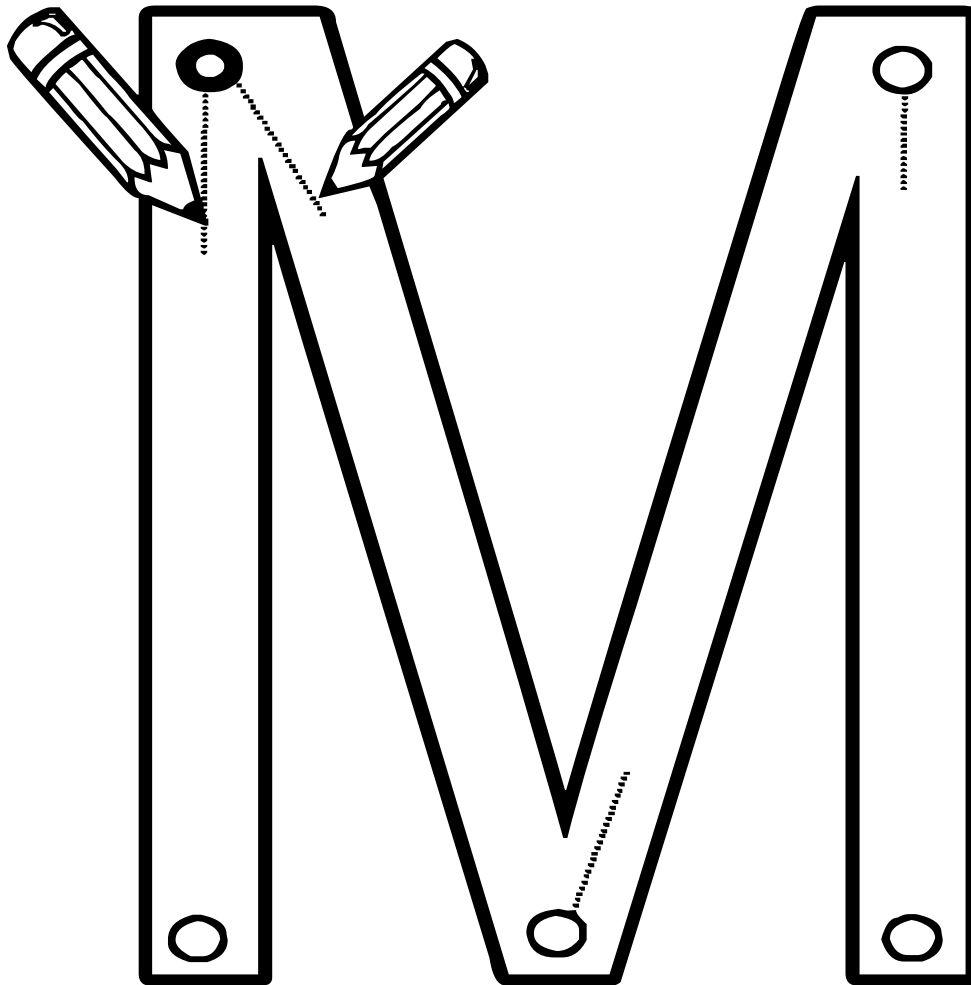

Nom \_\_\_\_\_

Date \_\_\_\_\_

## Ecris la lettre M / m

m m m m m

m m m m m

m m m m m

m m m m m

m m m m m

m m m m m

m m m m m

Nom \_\_\_\_\_

Date \_\_\_\_\_

# Ecris la lettre M / m

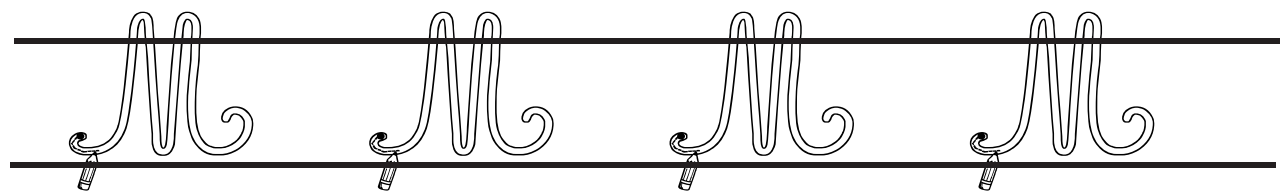
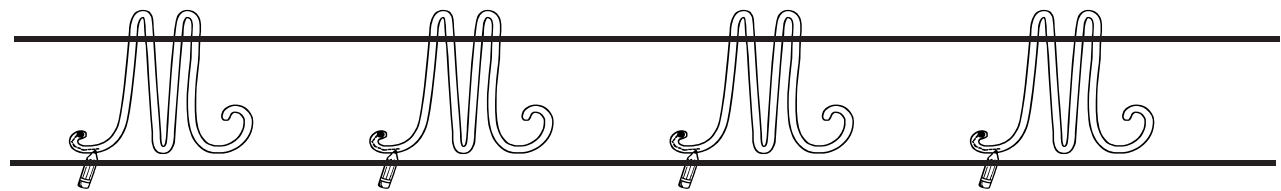
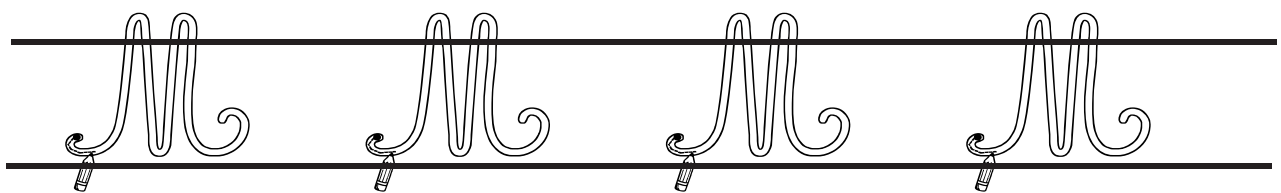
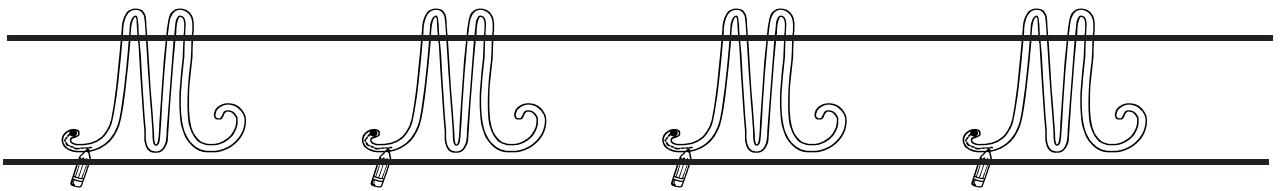
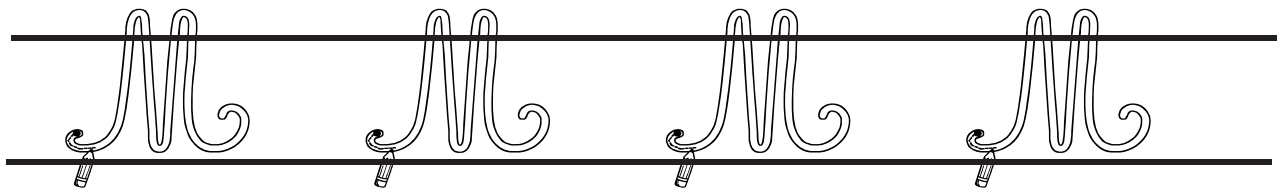
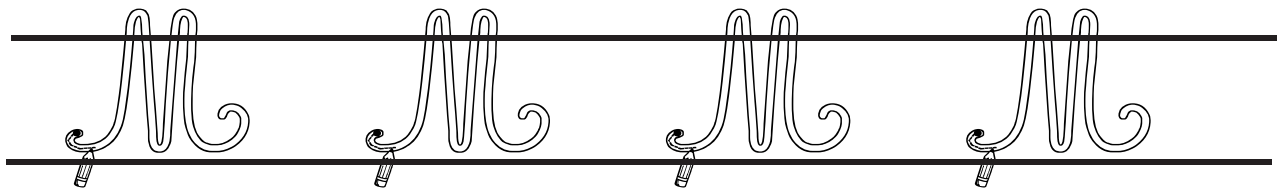
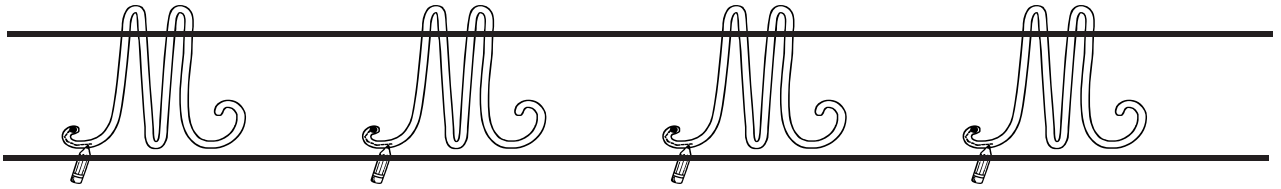

Nom \_\_\_\_\_ Date \_\_\_\_\_

## Ecris la lettre M/m

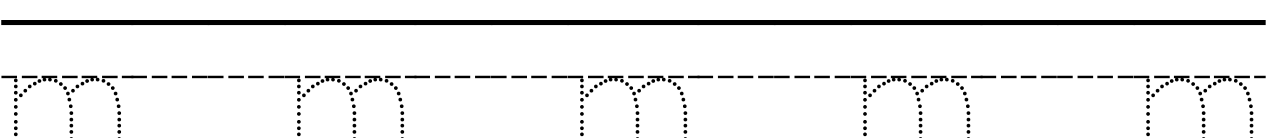
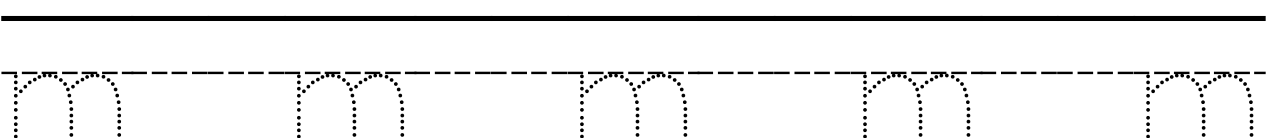
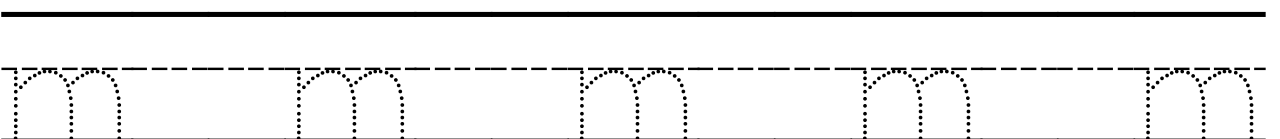
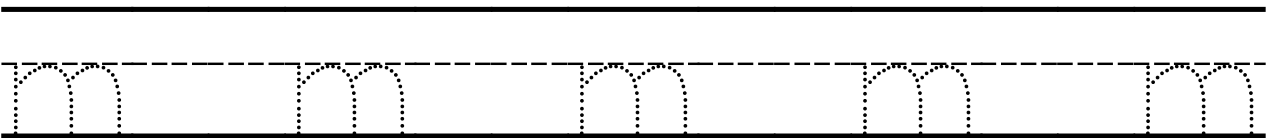
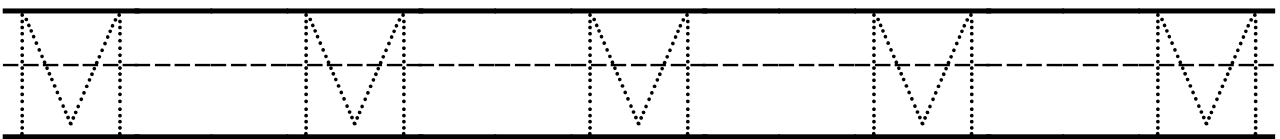
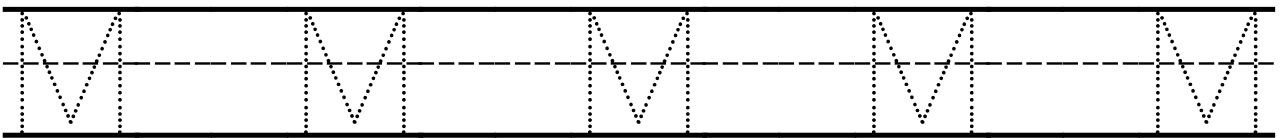
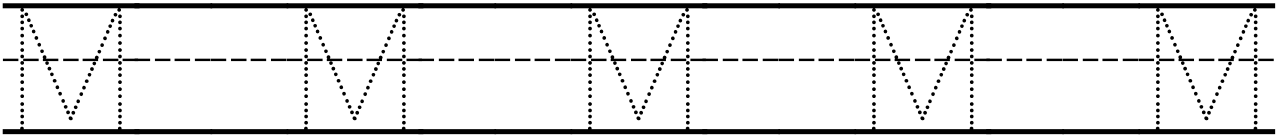
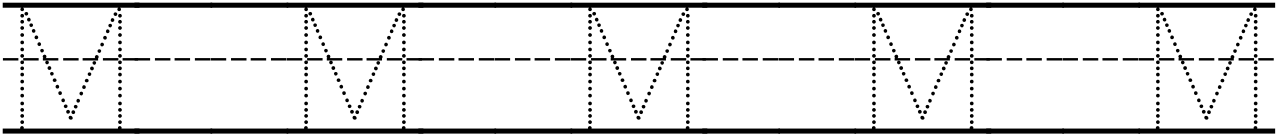

Nom \_\_\_\_\_ Date \_\_\_\_\_

Ecris la lettre M/m

M M M M M

Handwriting practice lines for uppercase letter M. The first row shows five examples of the letter M. Below are two sets of blank handwriting lines, each consisting of a solid top line, a dashed middle line, and a solid bottom line.

m m m m m

Handwriting practice lines for lowercase letter m. The first row shows five examples of the letter m. Below are two sets of blank handwriting lines, each consisting of a solid top line, a dashed middle line, and a solid bottom line.

Nom \_\_\_\_\_ Date \_\_\_\_\_

## Colorie la lettre M

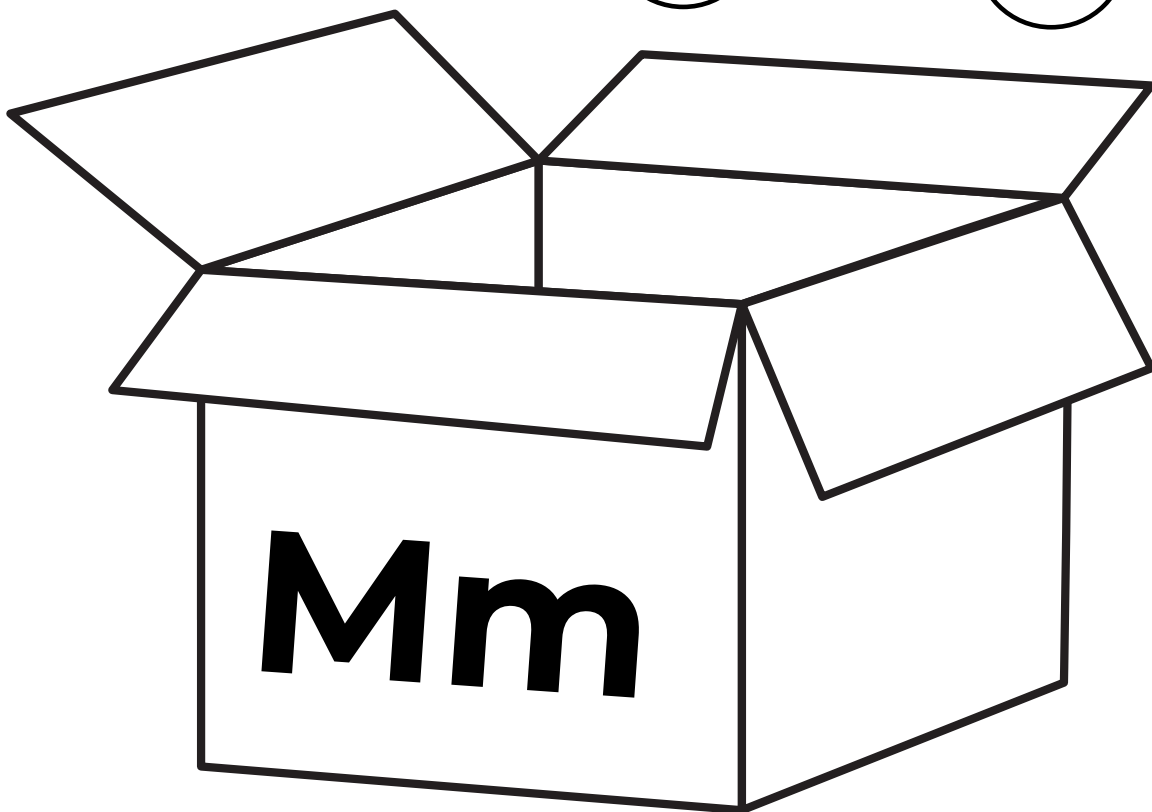
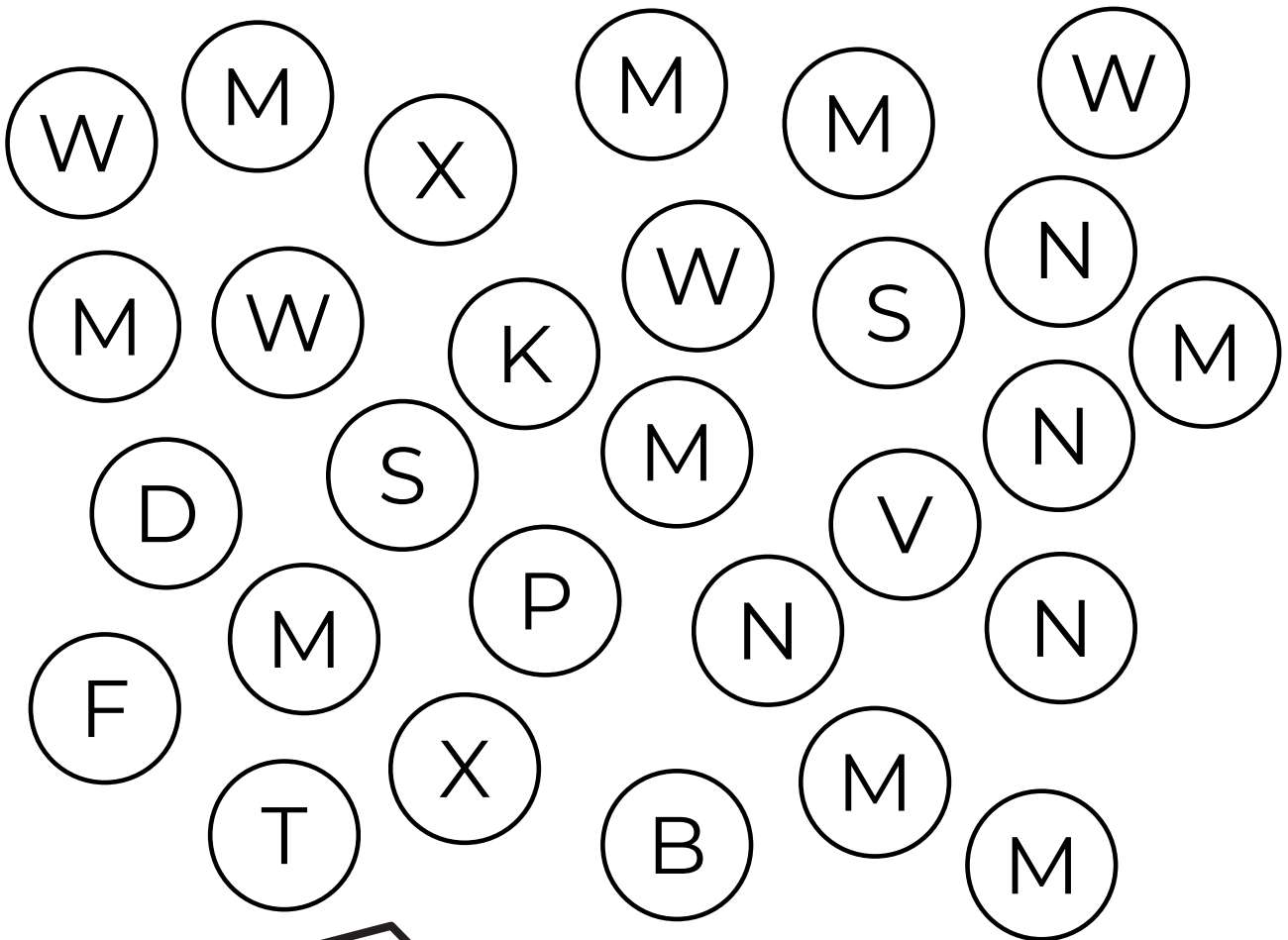

Nom \_\_\_\_\_

Date \_\_\_\_\_

Colorie la lettre m

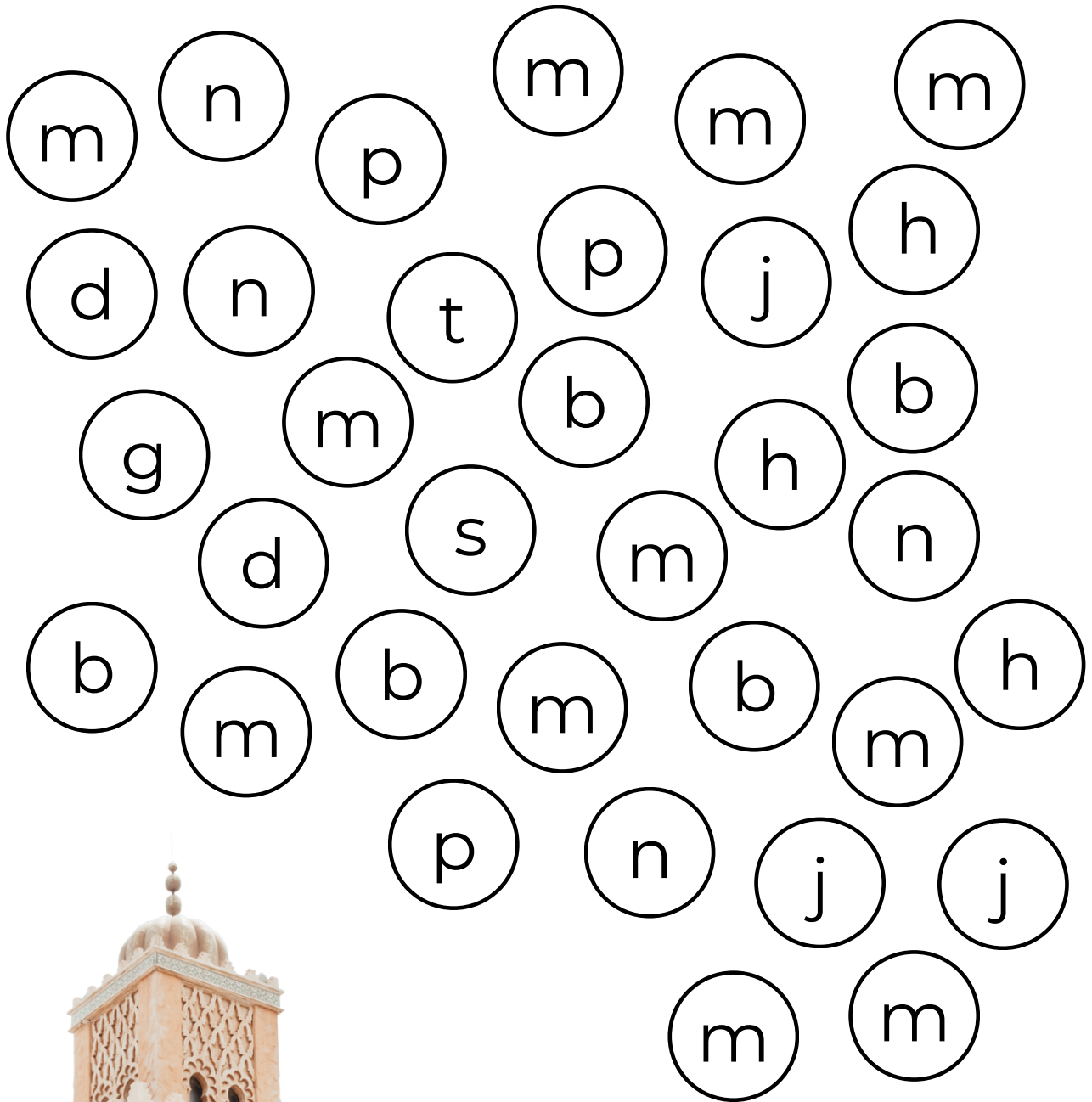

MOSQUEE / mosquée

Nom \_\_\_\_\_

Date \_\_\_\_\_

Repasse sur la lettre N / n

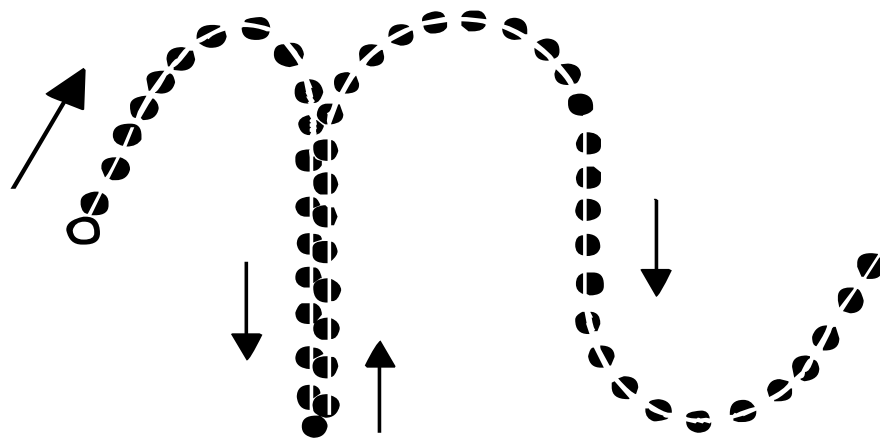

Nom \_\_\_\_\_

Date \_\_\_\_\_

Repasse sur la lettre N / n

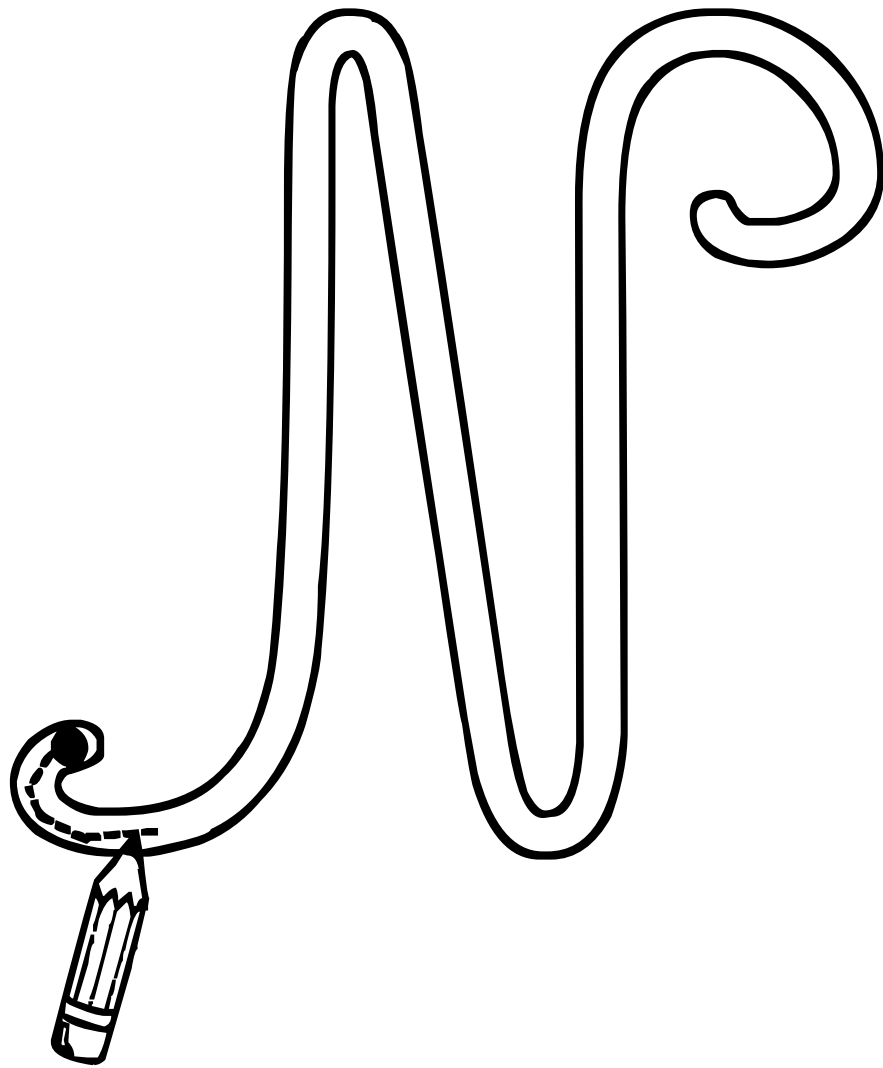

Nom \_\_\_\_\_

Date \_\_\_\_\_

Repasse sur la lettre N / n

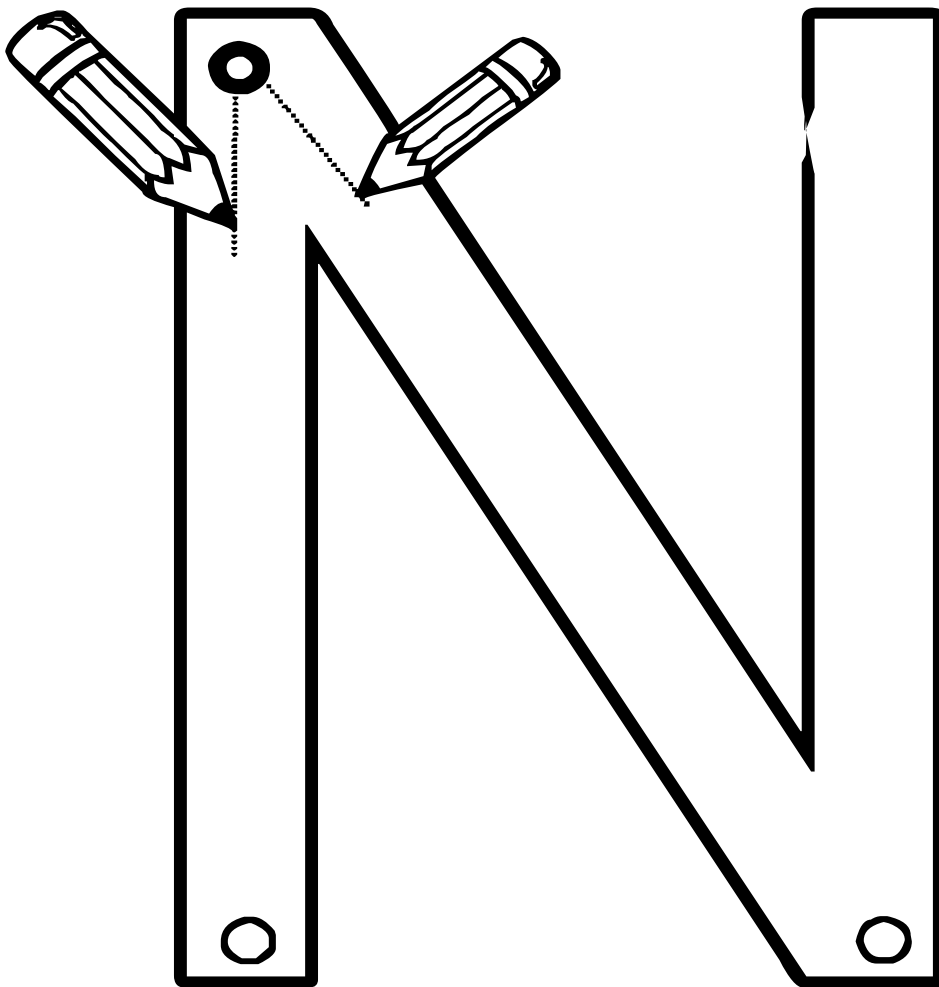

Nom \_\_\_\_\_

Date \_\_\_\_\_

## Ecris la lettre N / n

n n n n n n

n n n n n n

n n n n n n

n n n n n n

n n n n n n

n n n n n n

n n n n n n

Nom \_\_\_\_\_

Date \_\_\_\_\_

# Ecris la lettre N / n

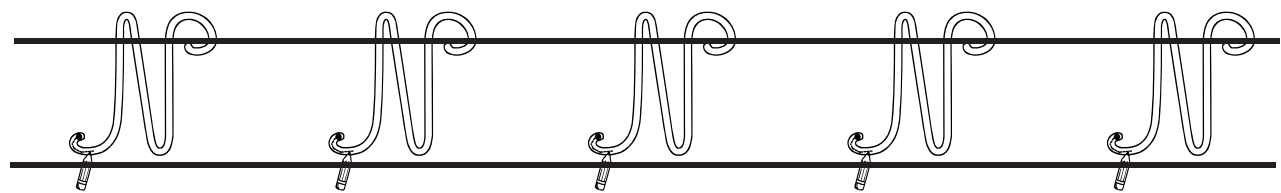
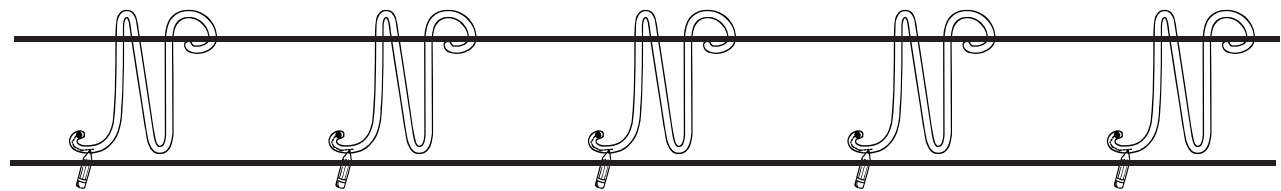
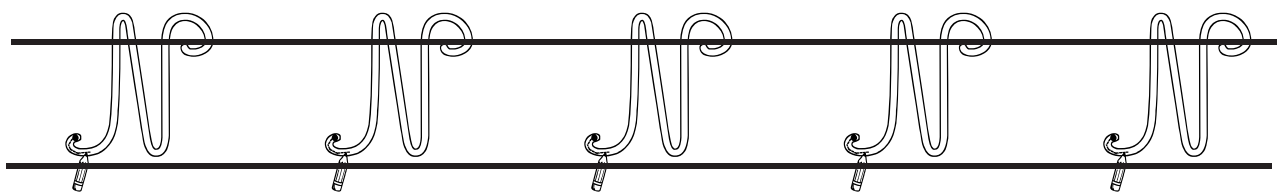
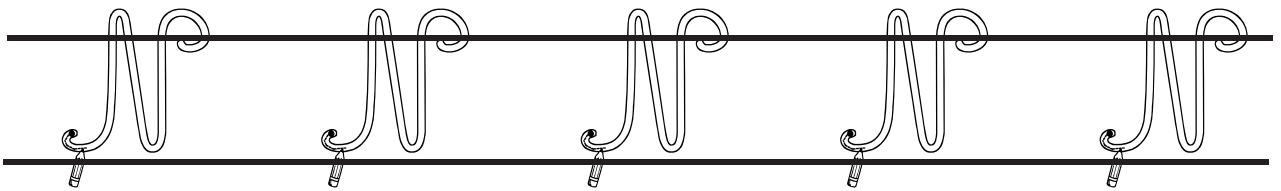
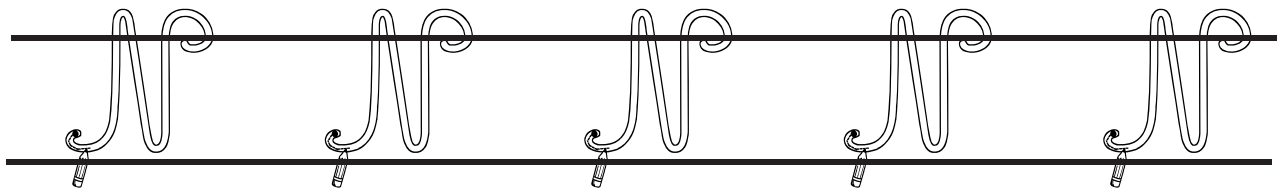
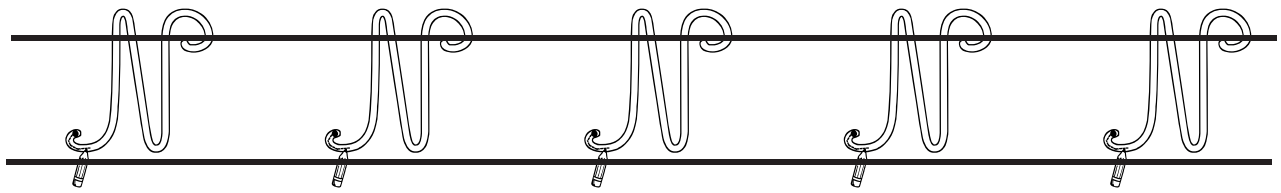
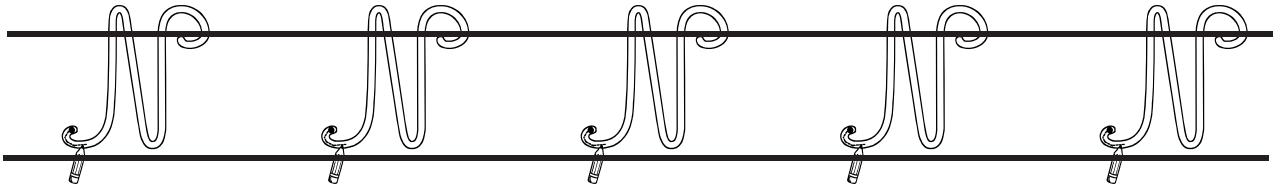

Nom \_\_\_\_\_

Date \_\_\_\_\_

## Ecris la lettre N/n

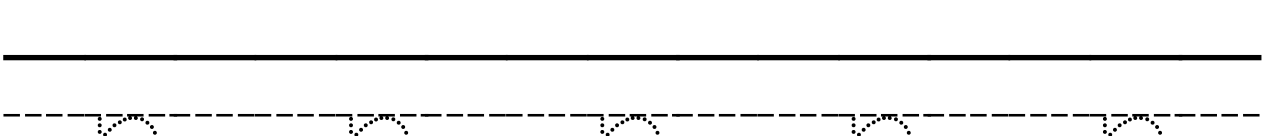
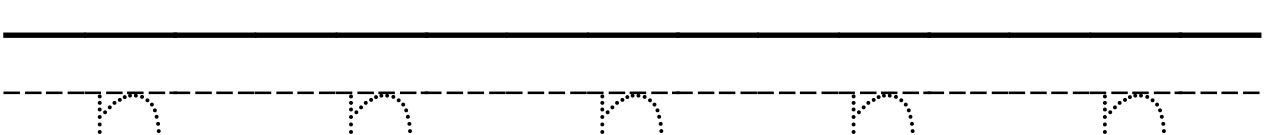
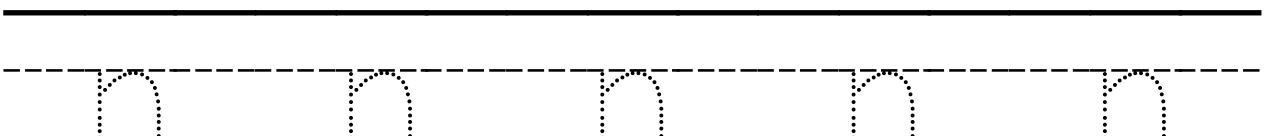
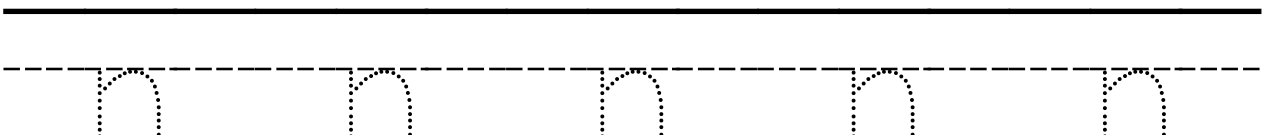
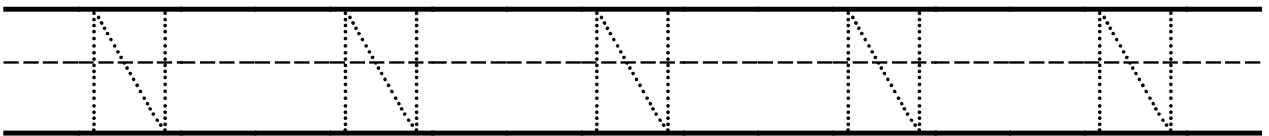
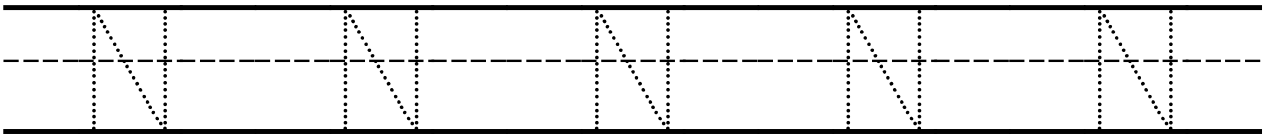
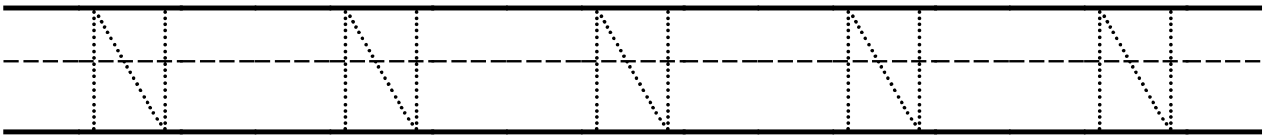
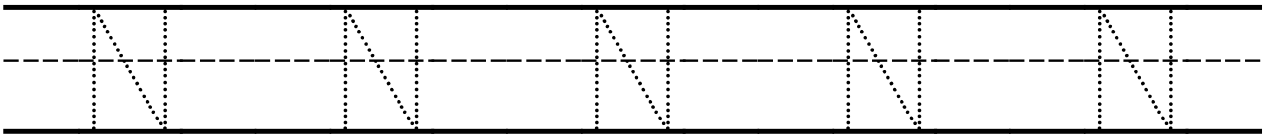

Nom \_\_\_\_\_ Date \_\_\_\_\_

Ecris la lettre N/n

N N N N N

Handwriting practice lines for uppercase letter N. Each set consists of a solid top line, a dashed middle line, and a solid bottom line. There are two such sets of lines provided for practice.

n n n n n

Handwriting practice lines for lowercase letter n. Each set consists of a solid top line, a dashed middle line, and a solid bottom line. There are two such sets of lines provided for practice.

Nom \_\_\_\_\_

Date \_\_\_\_\_

## Colorie la lettre N

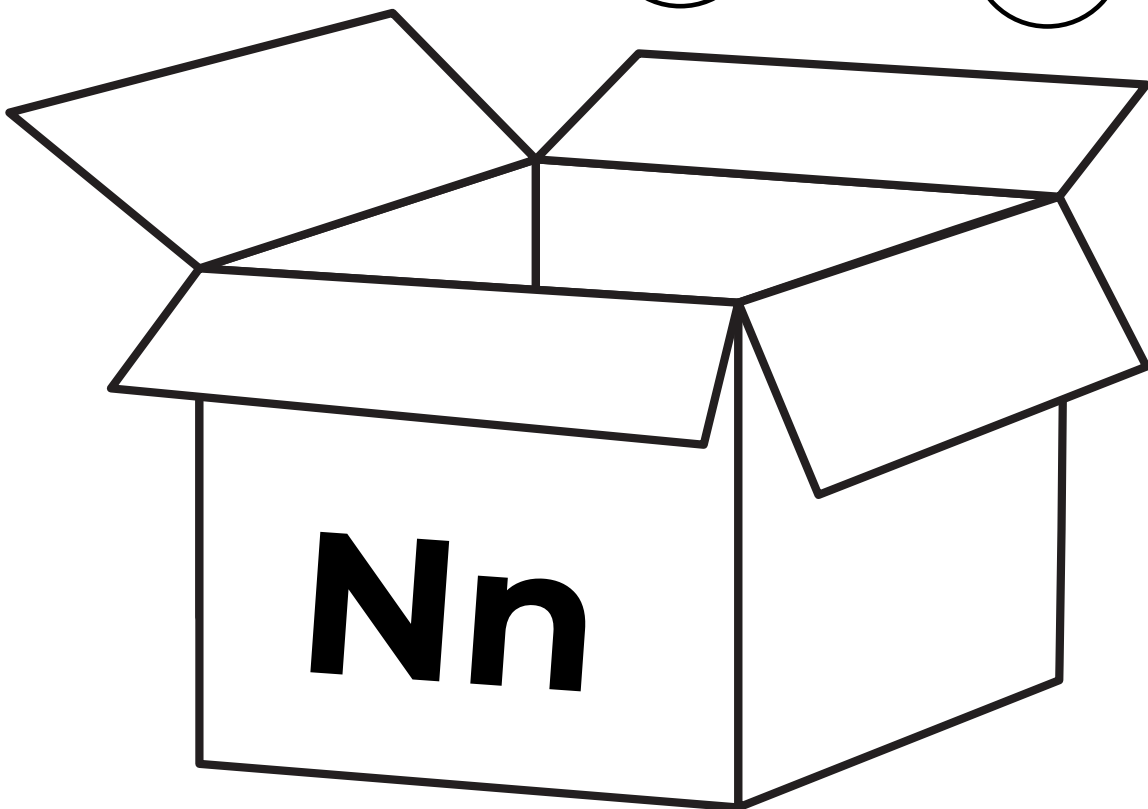
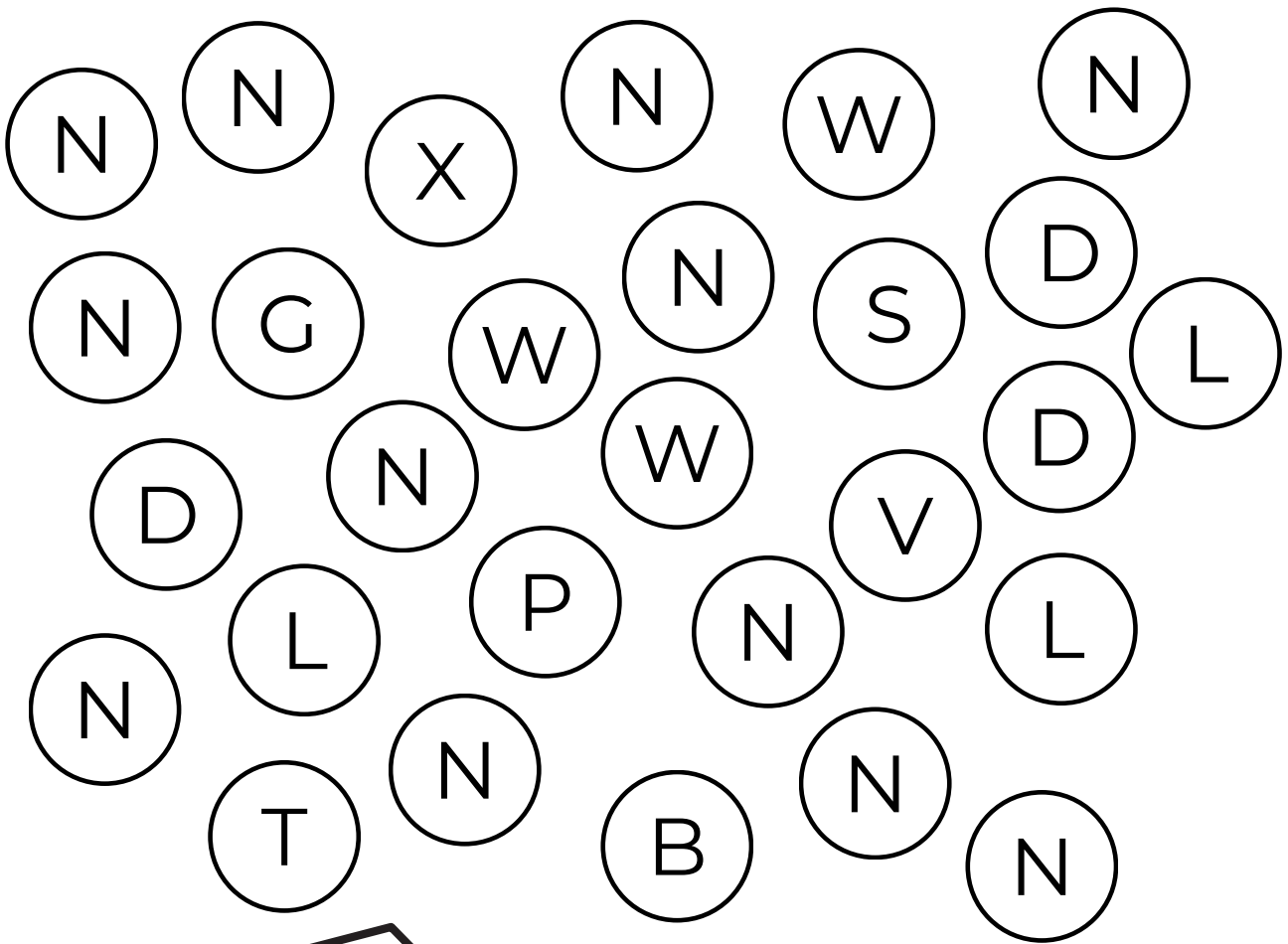

Nom \_\_\_\_\_

Date \_\_\_\_\_

Colorie la lettre n

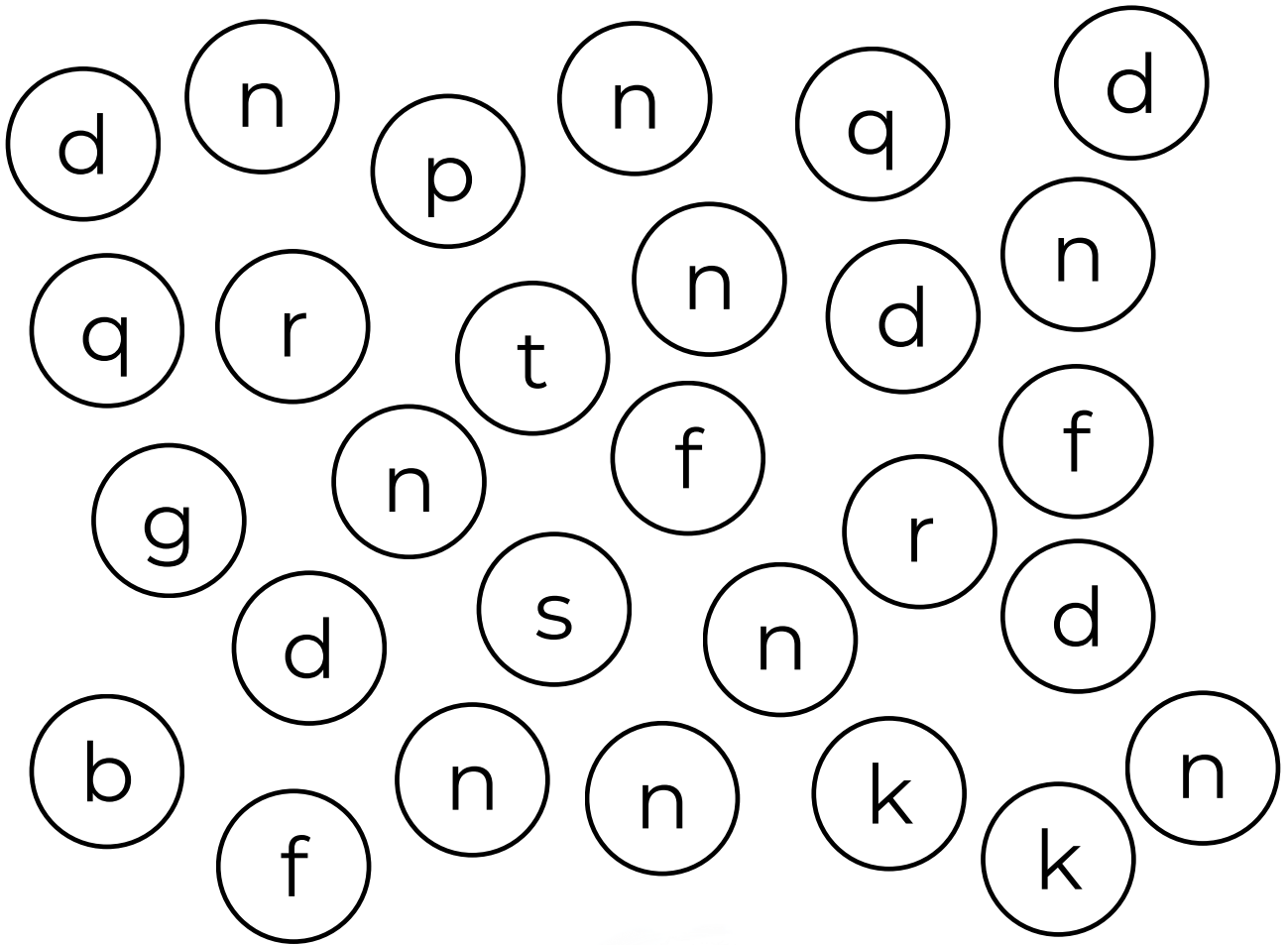

NUAGE / nuage

Nom \_\_\_\_\_

Date \_\_\_\_\_

Repasse sur la lettre O / o

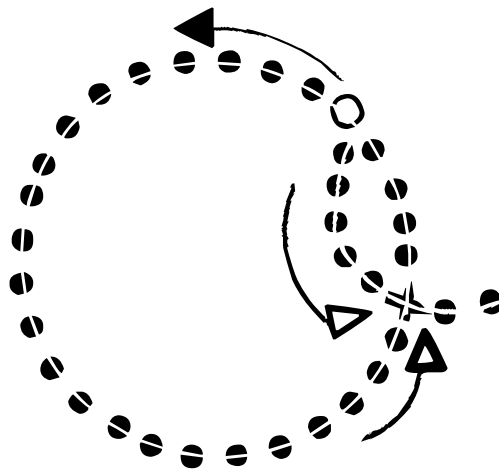

Nom \_\_\_\_\_

Date \_\_\_\_\_

Repasse sur la lettre O / o

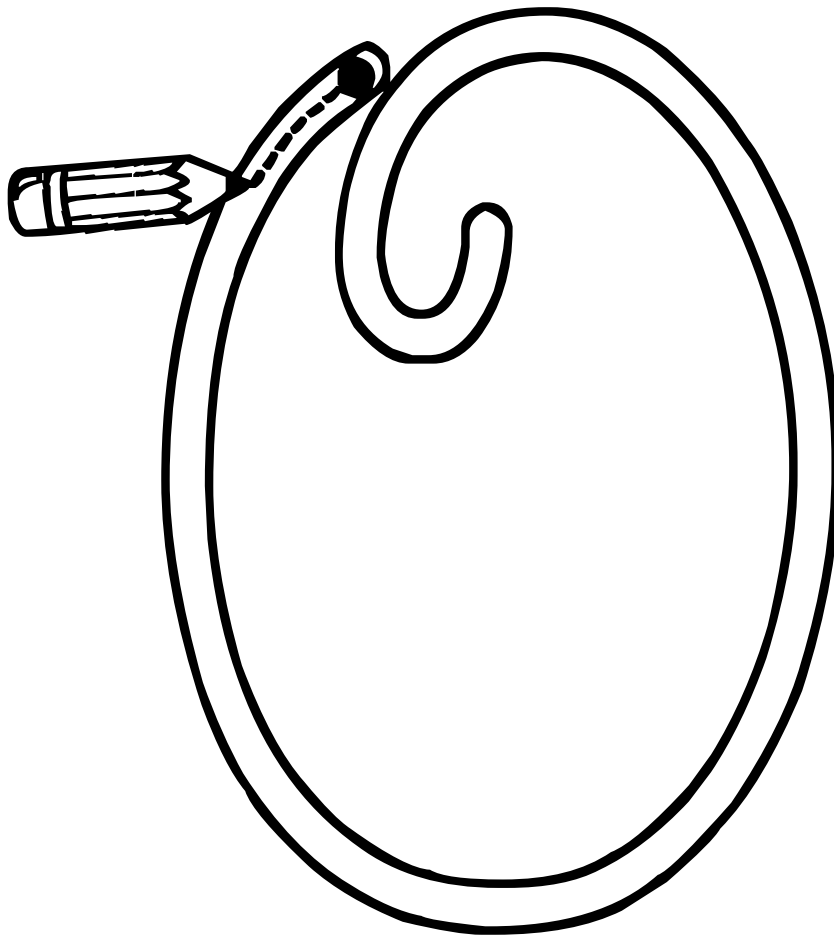

Nom \_\_\_\_\_

Date \_\_\_\_\_

Repasse sur la lettre O / o

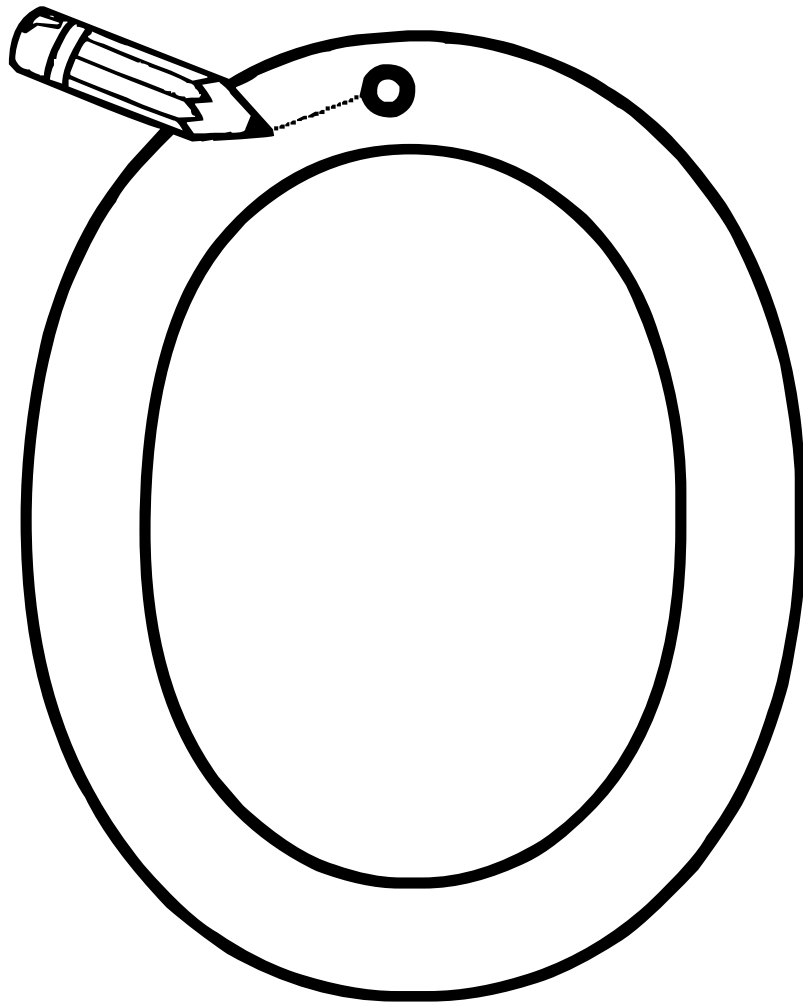

Nom \_\_\_\_\_ Date \_\_\_\_\_

# Ecris la lettre O / o



Nom \_\_\_\_\_

Date \_\_\_\_\_

# Ecris la lettre O / o

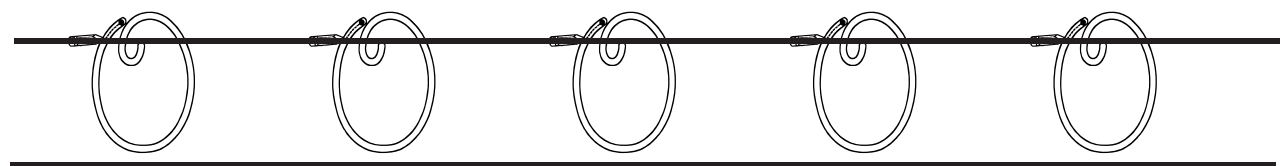
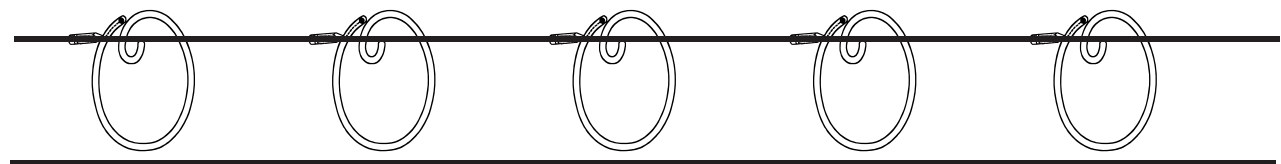
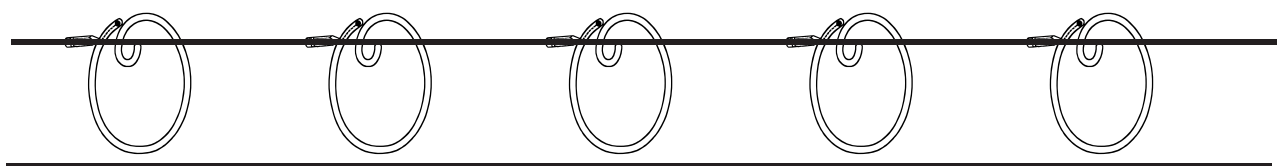
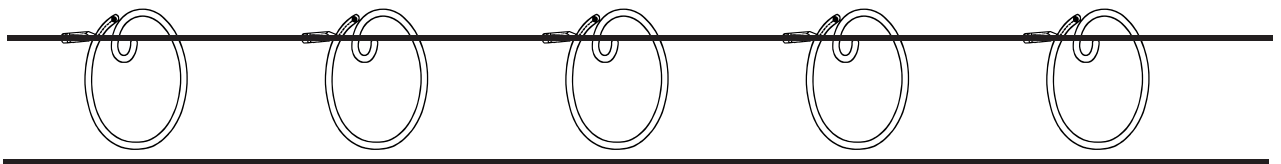
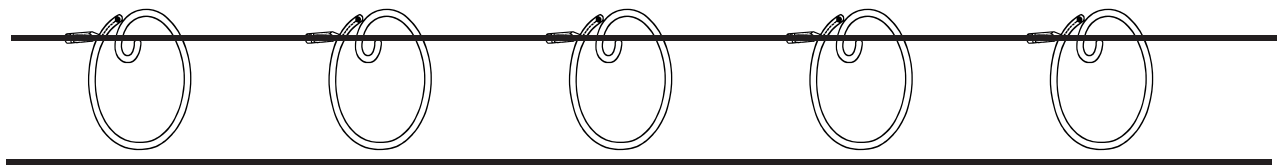
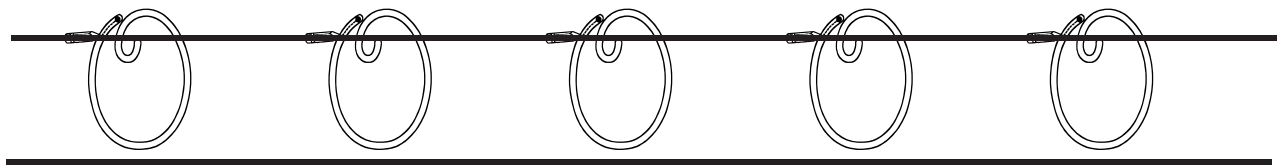
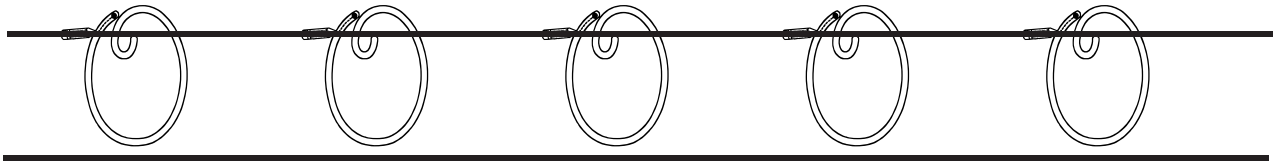

Nom \_\_\_\_\_ Date \_\_\_\_\_

## Ecris la lettre O/o

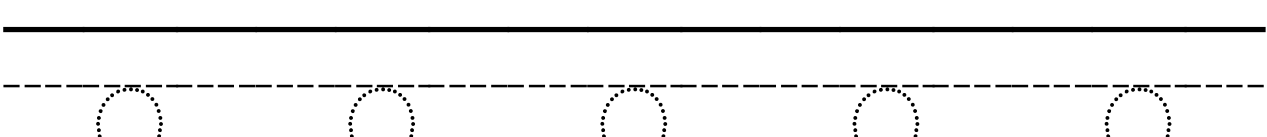
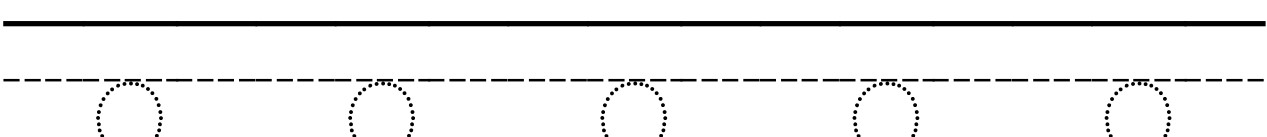
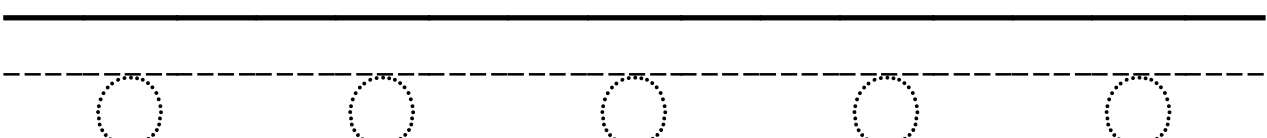
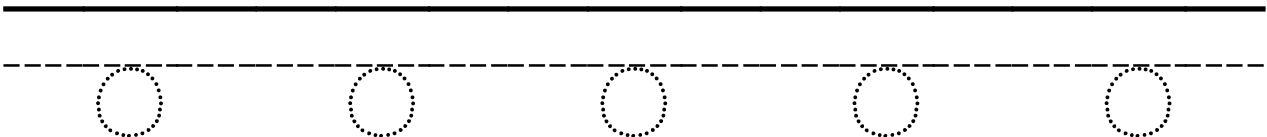
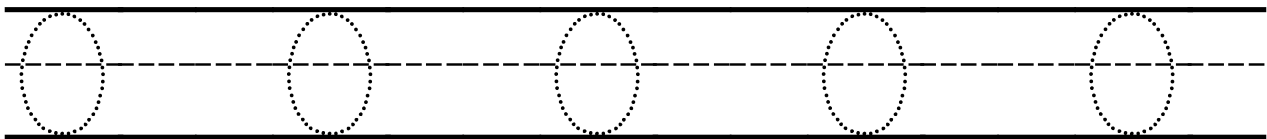
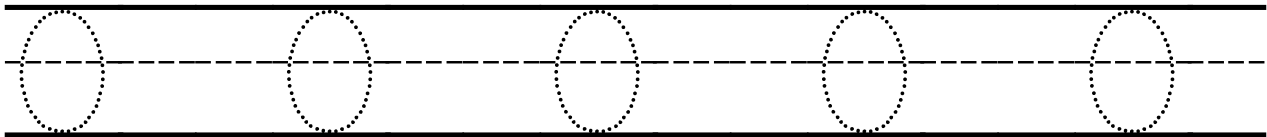
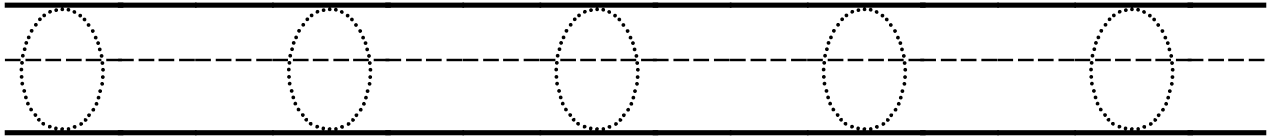
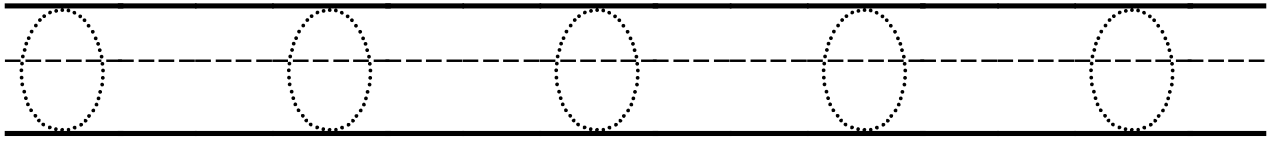

Nom \_\_\_\_\_ Date \_\_\_\_\_

Ecris la lettre O/o

O O O O O

Handwriting practice lines for uppercase 'O'. Each set consists of a solid top line, a dashed middle line, and a solid bottom line. There are two such sets of lines provided for practice.

o o o o o

Handwriting practice lines for lowercase 'o'. Each set consists of a solid top line, a dashed middle line, and a solid bottom line. There are two such sets of lines provided for practice.

Nom \_\_\_\_\_

Date \_\_\_\_\_

# Colorie la lettre O

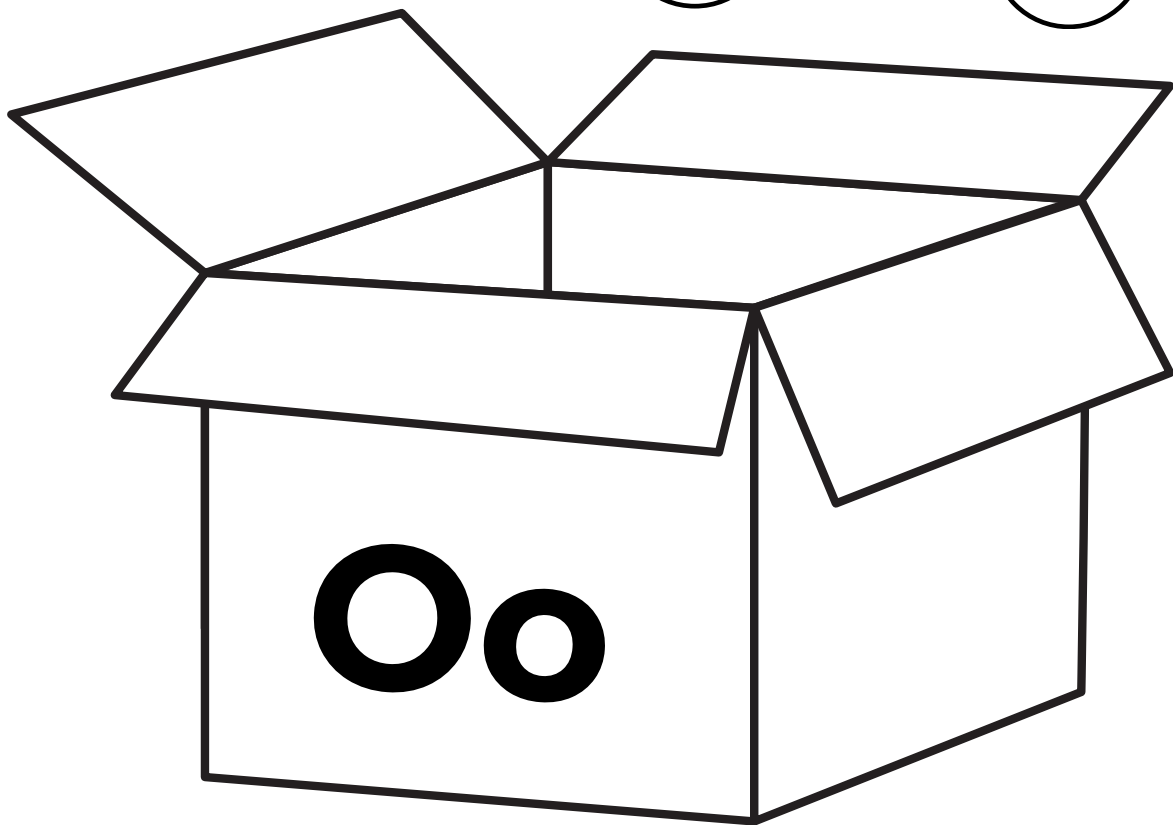
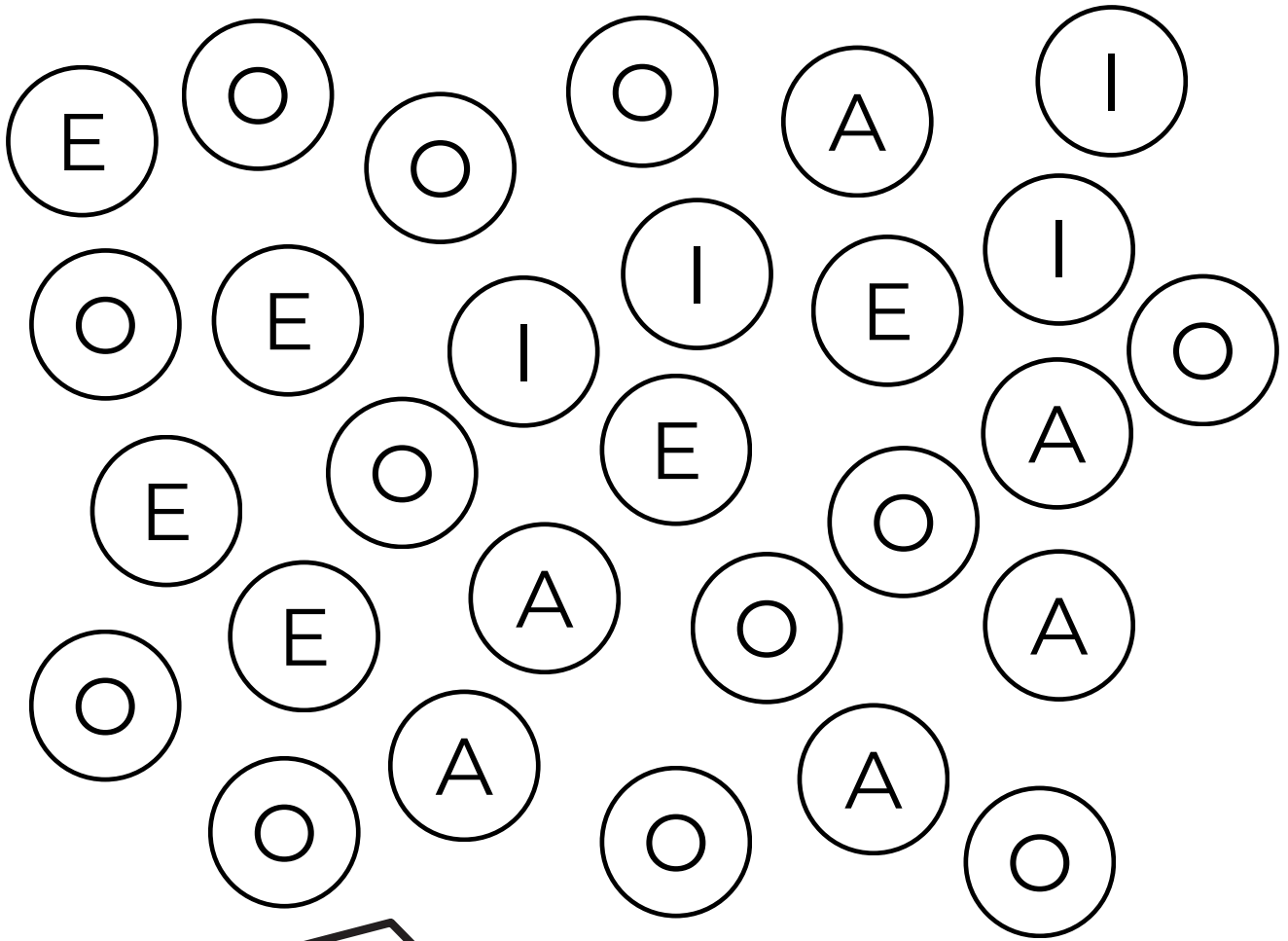

Nom \_\_\_\_\_

Date \_\_\_\_\_

### Colorie la lettre o

a o e o o o

o a a o o o

a a o e

e o o e o

u o a

u e u

u o e

o o

o



OLIVE / olive

Nom \_\_\_\_\_

Date \_\_\_\_\_

Repasse sur la lettre P / p

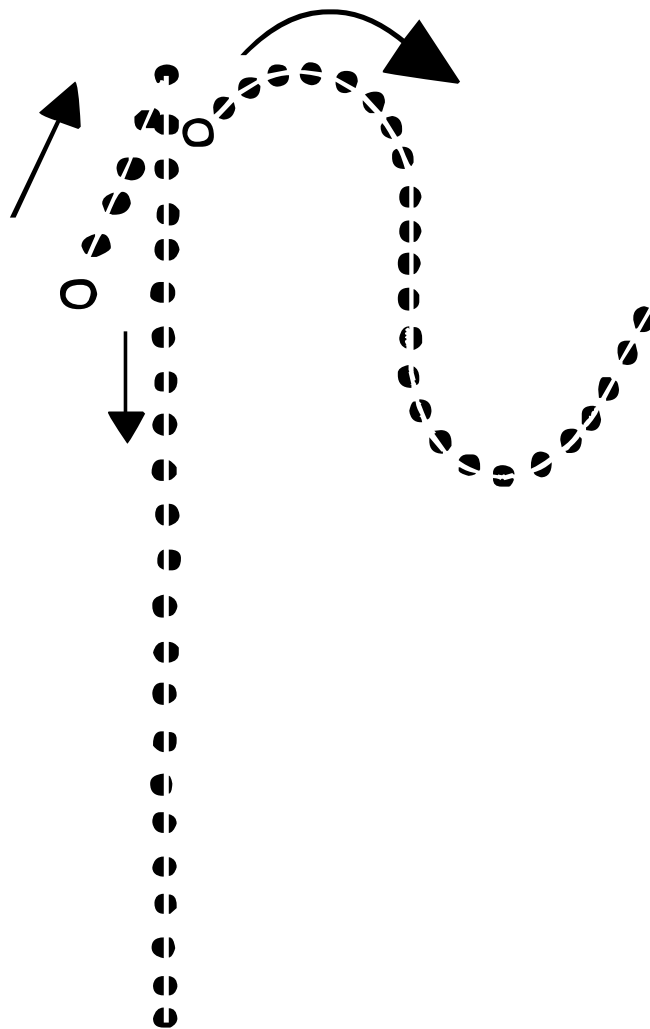

Nom \_\_\_\_\_

Date \_\_\_\_\_

Repasse sur la lettre P / p

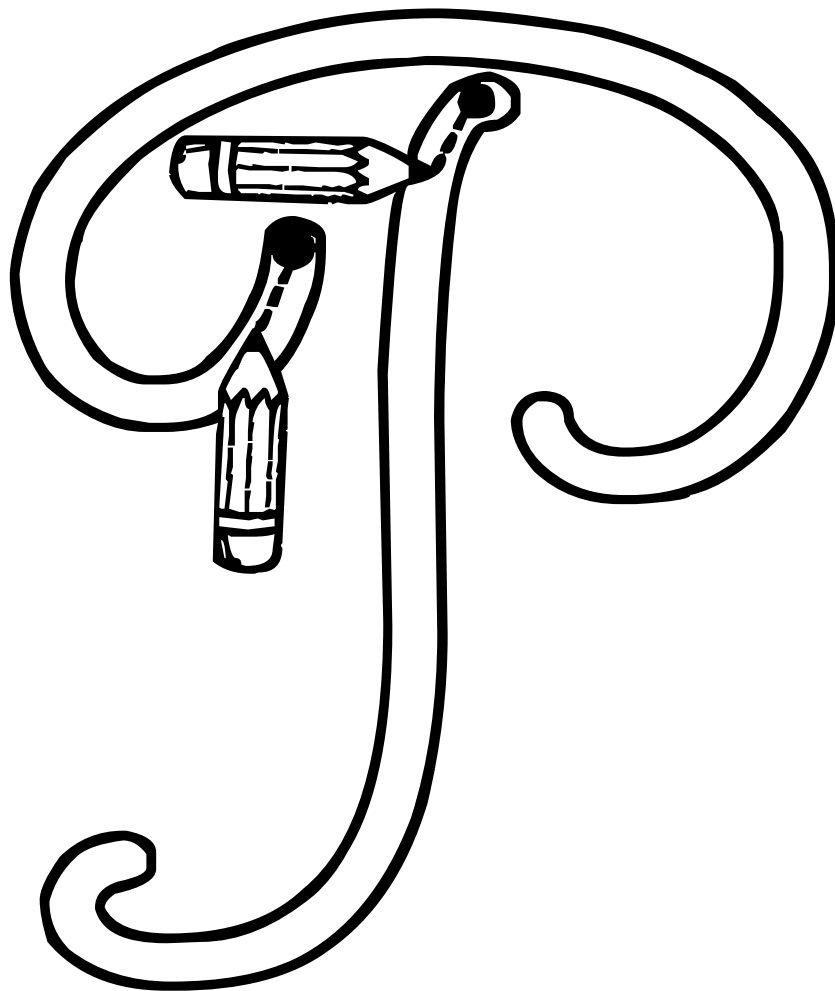

Nom \_\_\_\_\_

Date \_\_\_\_\_

Repasse sur la lettre P / p

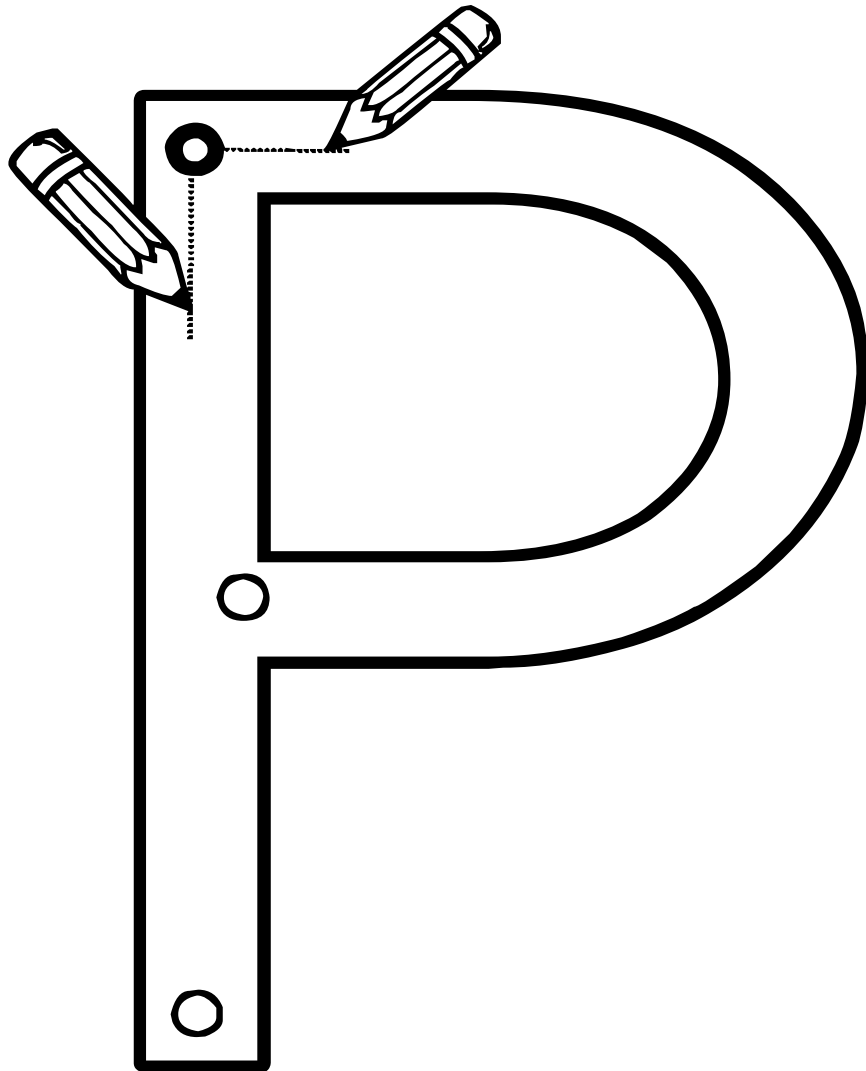

Nom \_\_\_\_\_

Date \_\_\_\_\_

# Ecris la lettre P / p

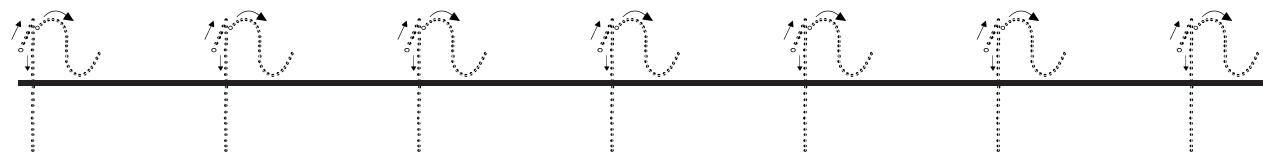
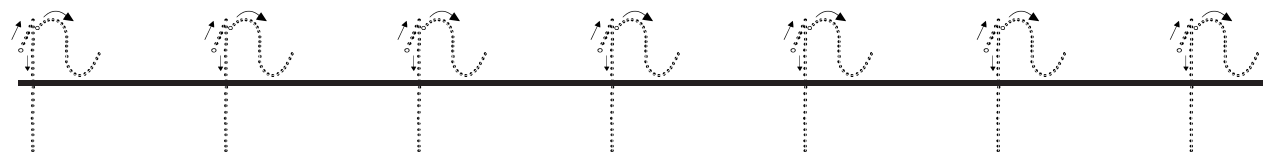
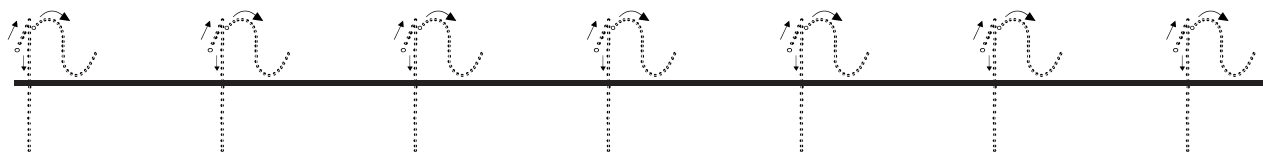
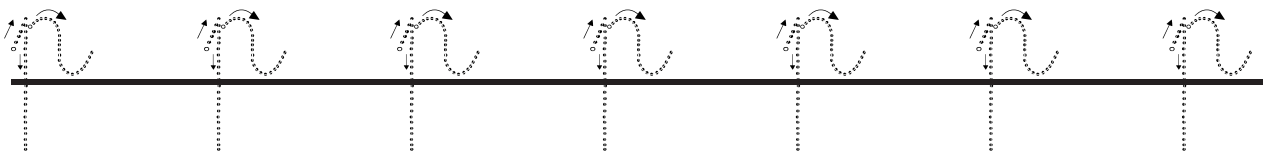
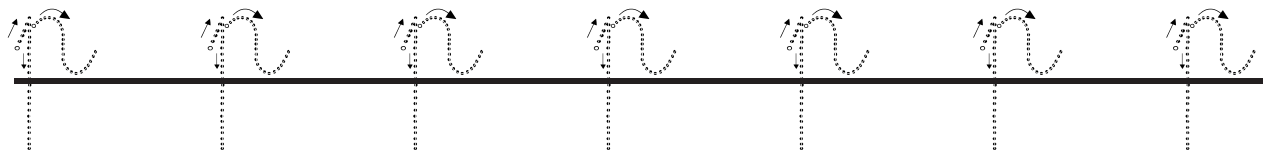
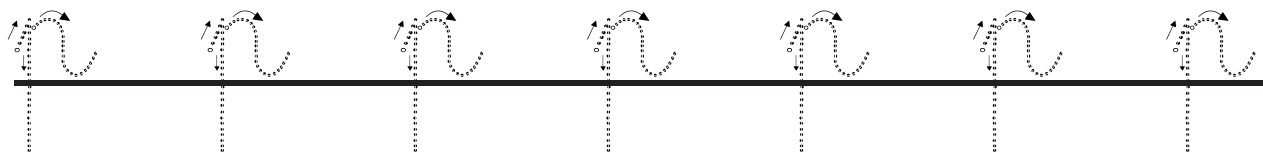
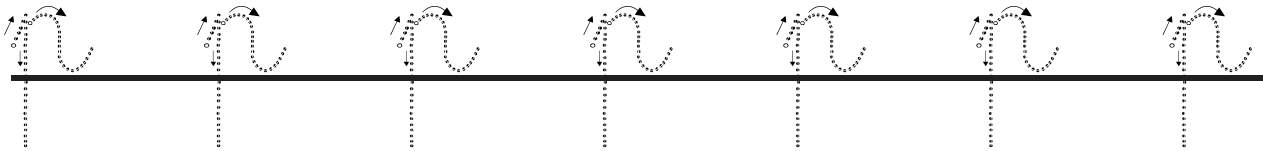

Nom \_\_\_\_\_

Date \_\_\_\_\_

# Ecris la lettre P / p

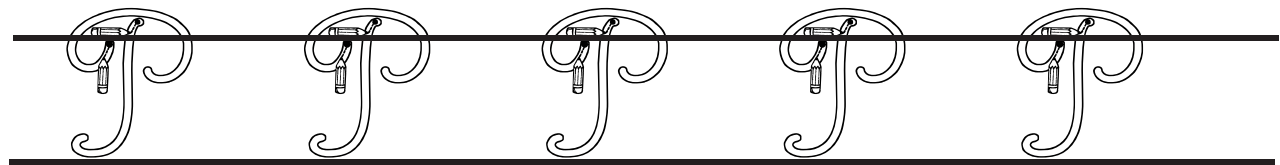
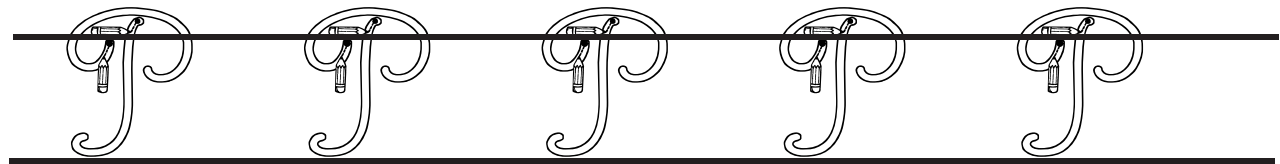
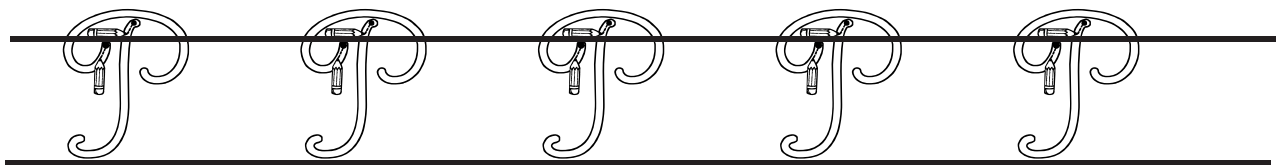
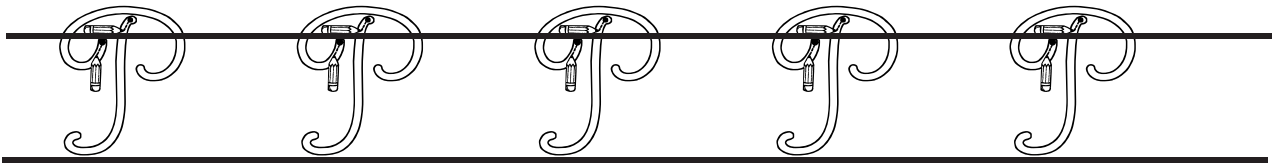
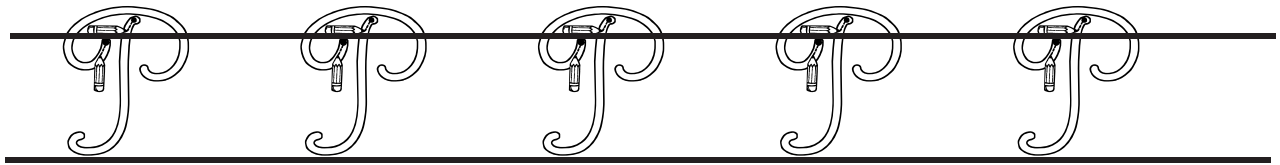
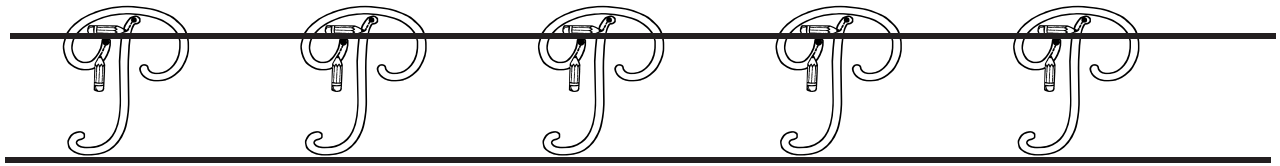
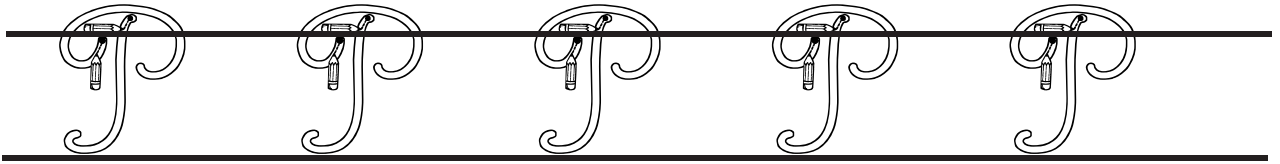

Nom \_\_\_\_\_

Date \_\_\_\_\_

# Ecris la lettre P/p

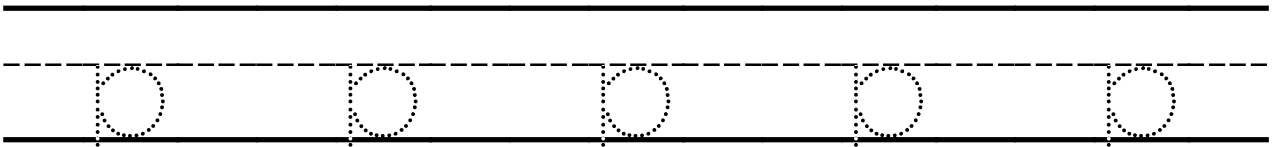
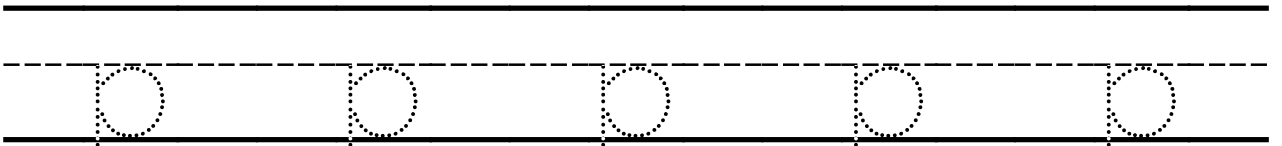
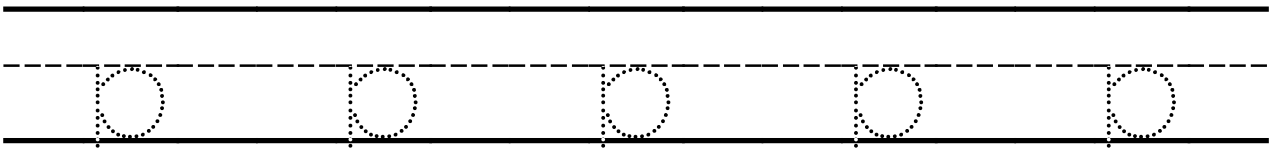
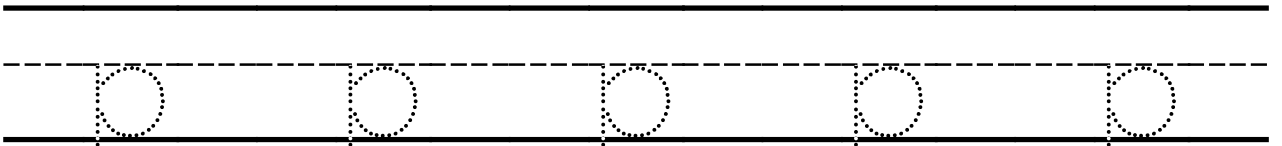
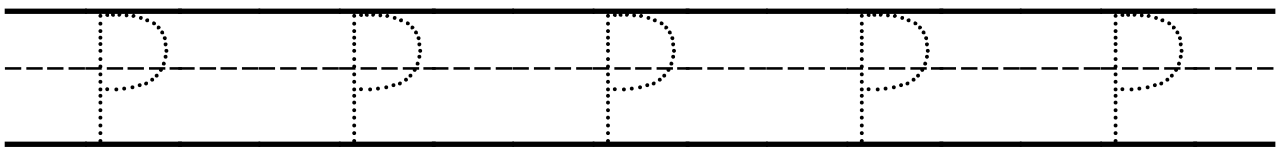
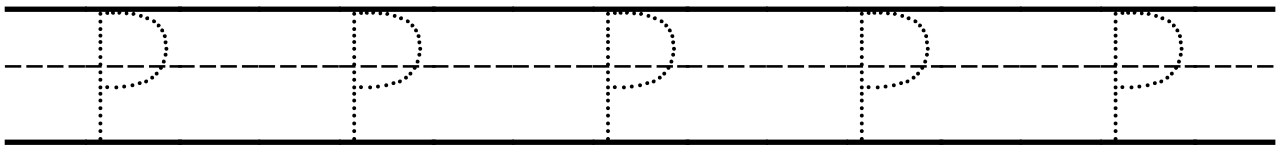
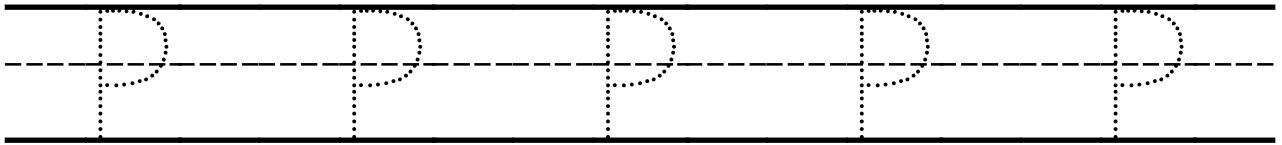
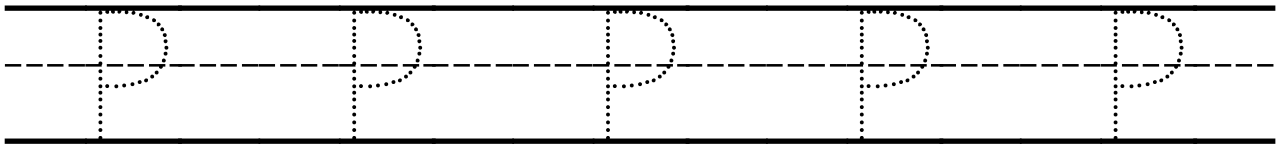

Nom \_\_\_\_\_ Date \_\_\_\_\_

Ecris la lettre P/p

P P P P P

Handwriting practice lines for uppercase letter P. Each row consists of a solid top line, a dashed middle line, and a solid bottom line. There are two such rows provided for practice.

p p p p p

Handwriting practice lines for lowercase letter p. Each row consists of a solid top line, a dashed middle line, and a solid bottom line. There are two such rows provided for practice.

Nom \_\_\_\_\_

Date \_\_\_\_\_

Colorie la lettre P

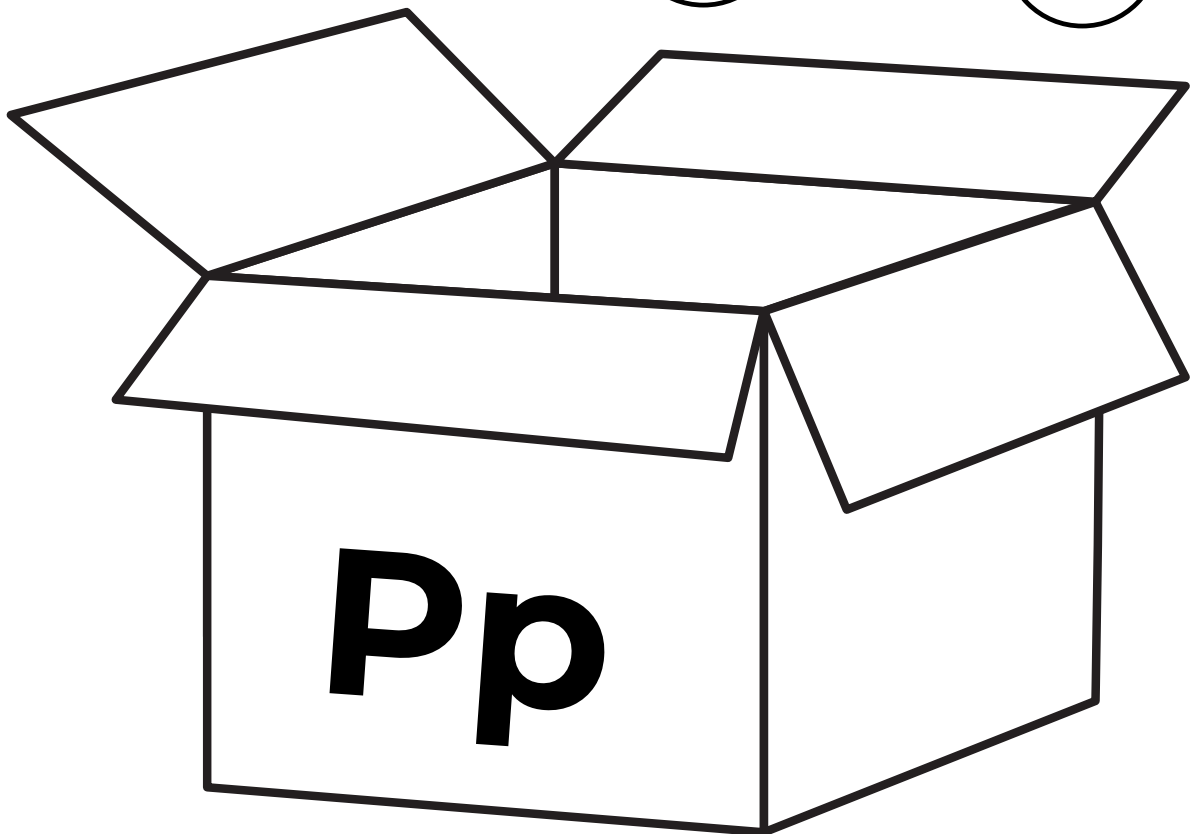
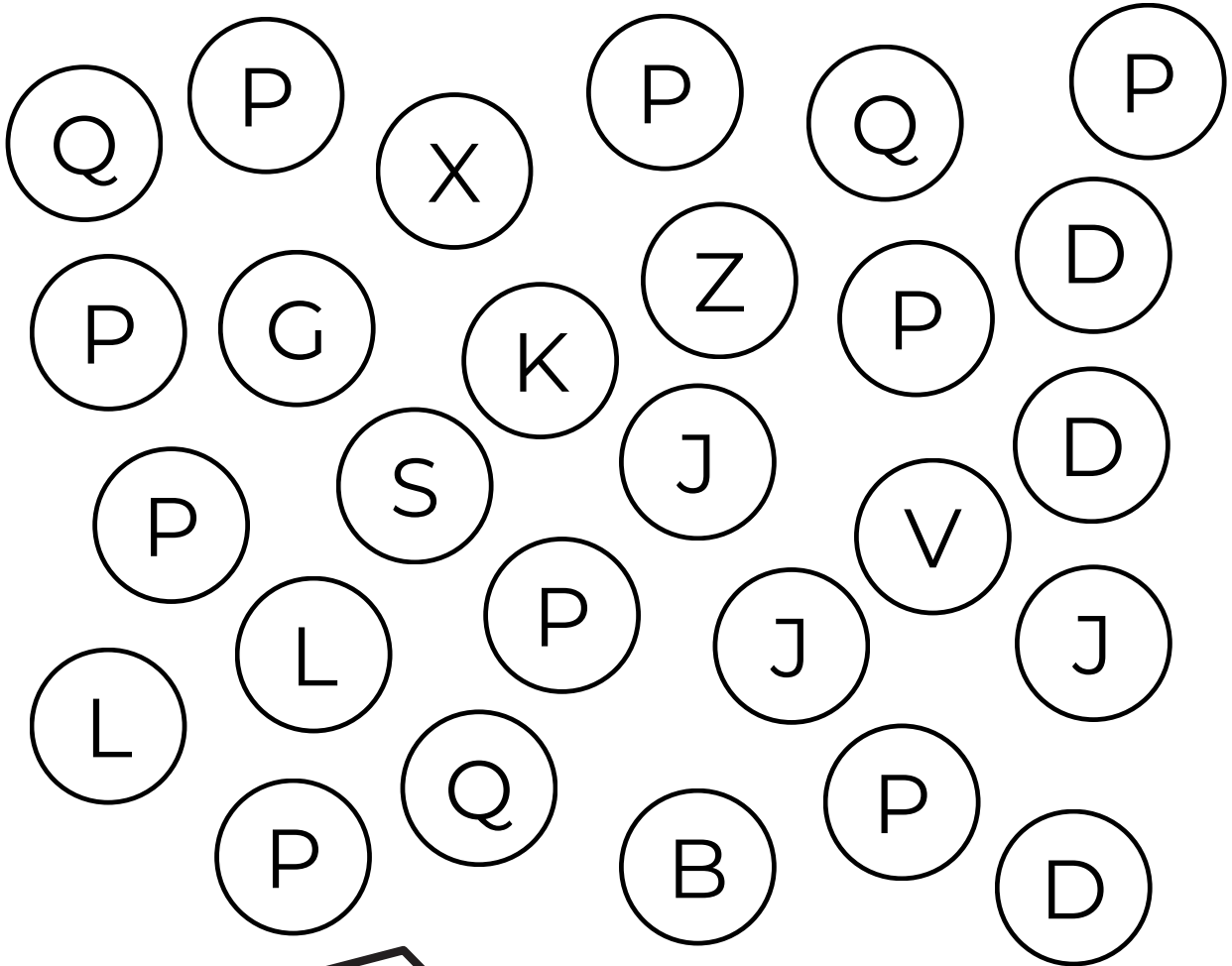

Nom \_\_\_\_\_

Date \_\_\_\_\_

Ecris la lettre p

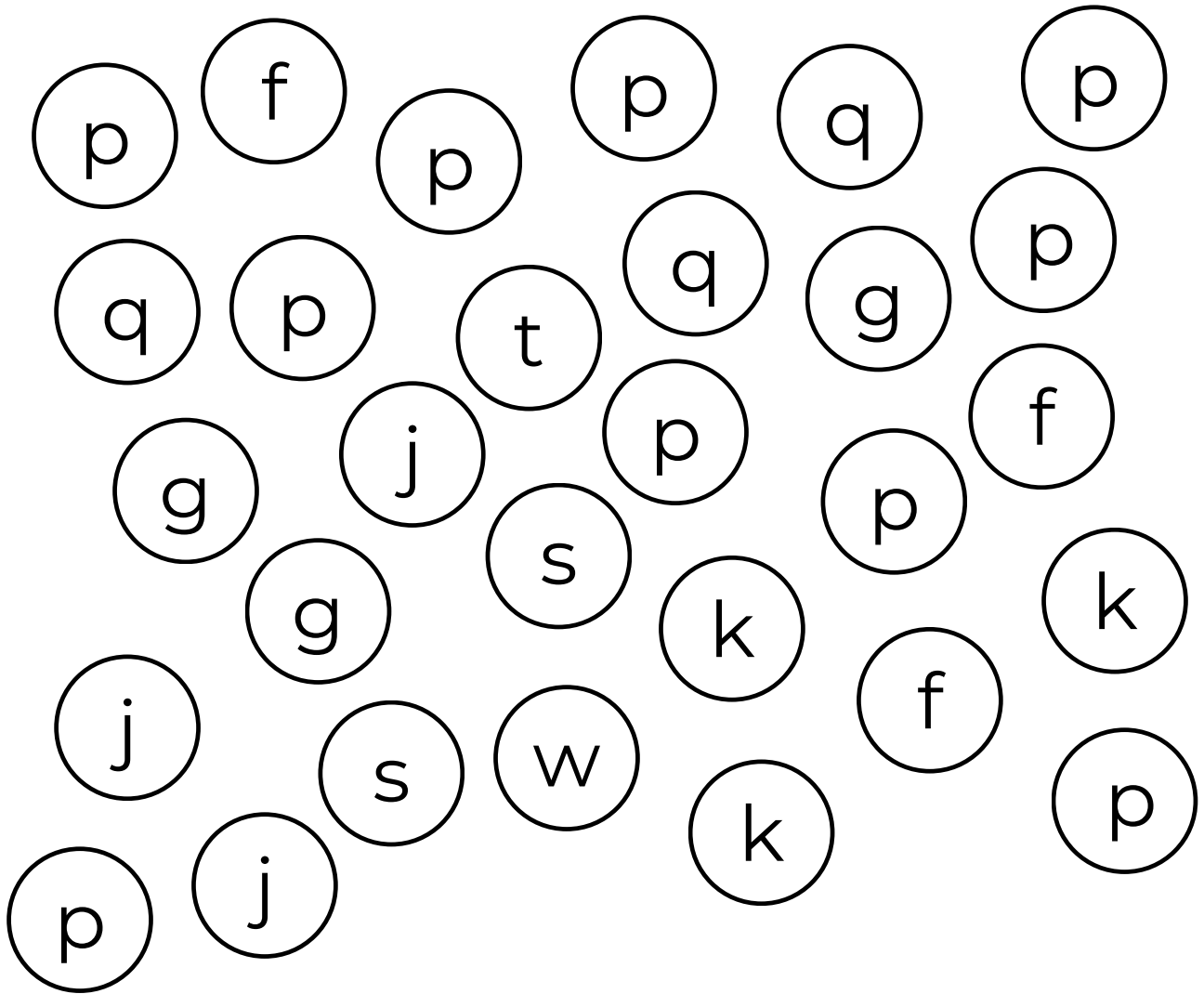

PRIERE / prière



Nom \_\_\_\_\_

Date \_\_\_\_\_

Repasse sur la lettre Q / q

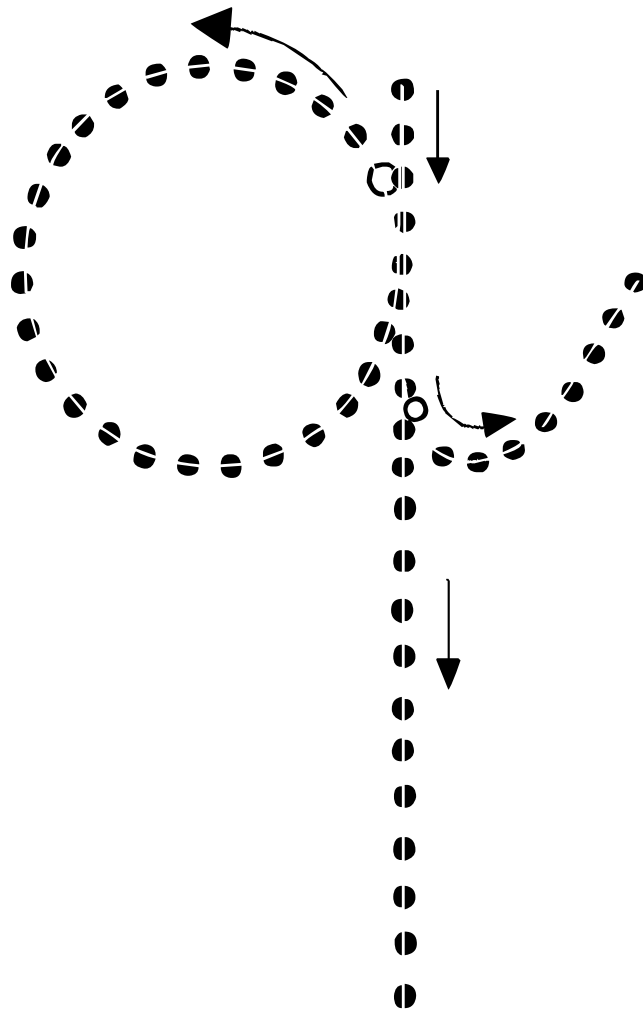

Nom \_\_\_\_\_

Date \_\_\_\_\_

Repasse sur la lettre Q / q

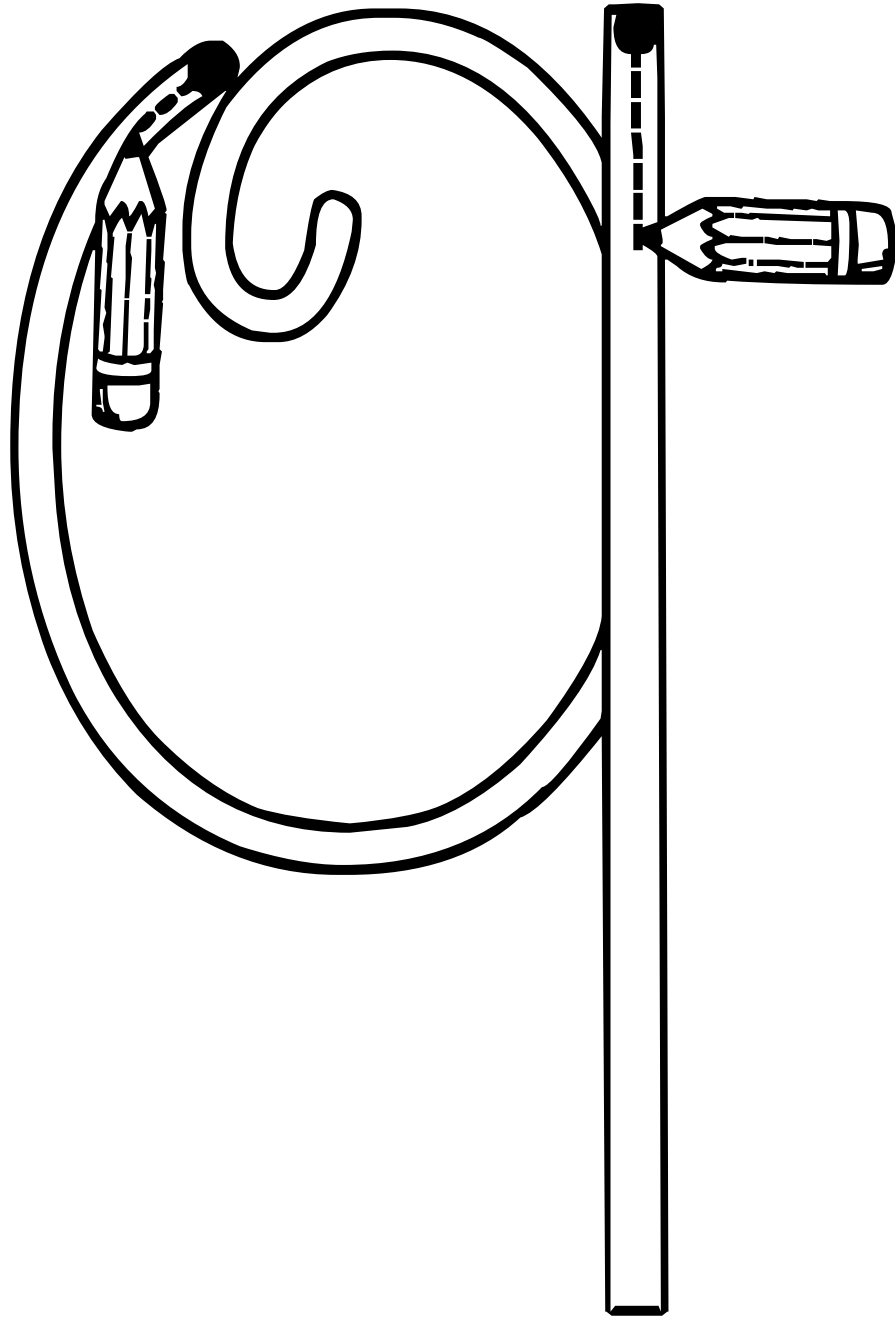

Nom \_\_\_\_\_

Date \_\_\_\_\_

Repasse sur la lettre Q / q

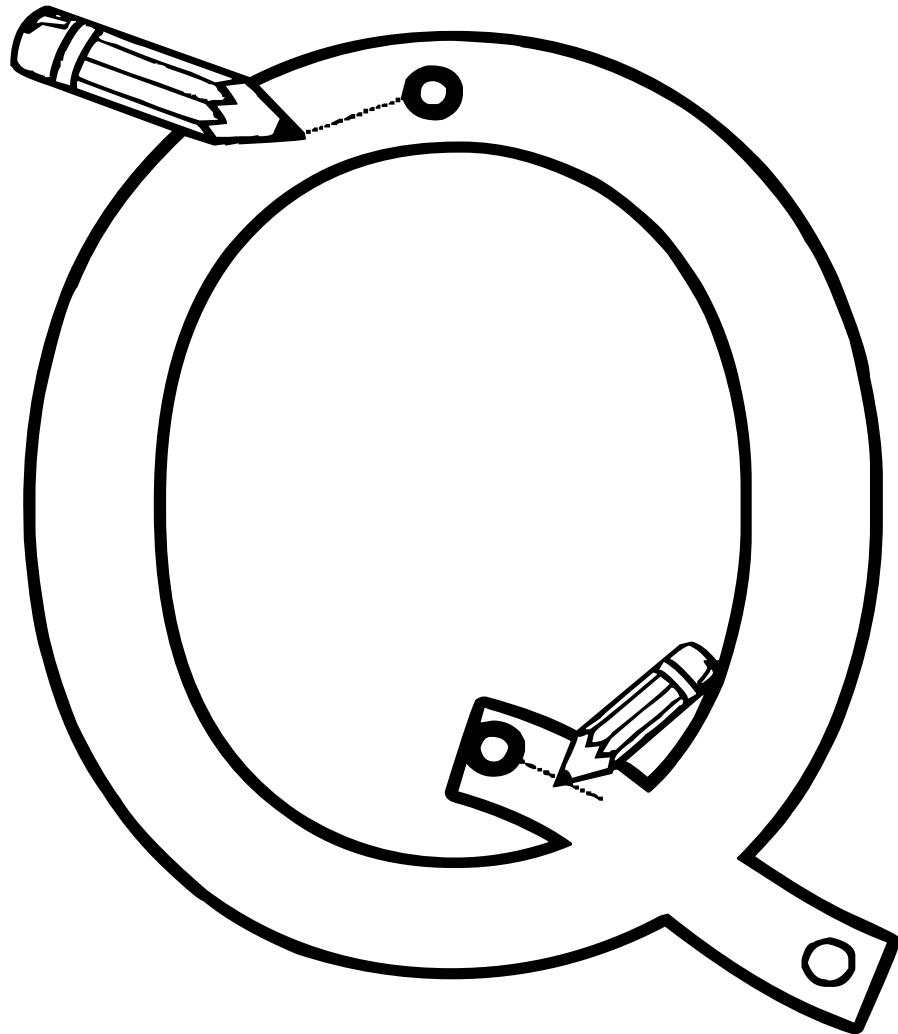

Nom \_\_\_\_\_

Date \_\_\_\_\_

## Ecris la lettre Q / q

q q q q q q

q q q q q q

q q q q q q

q q q q q q

q q q q q q

q q q q q q

q q q q q q

Nom \_\_\_\_\_

Date \_\_\_\_\_

# Ecris la lettre R / r

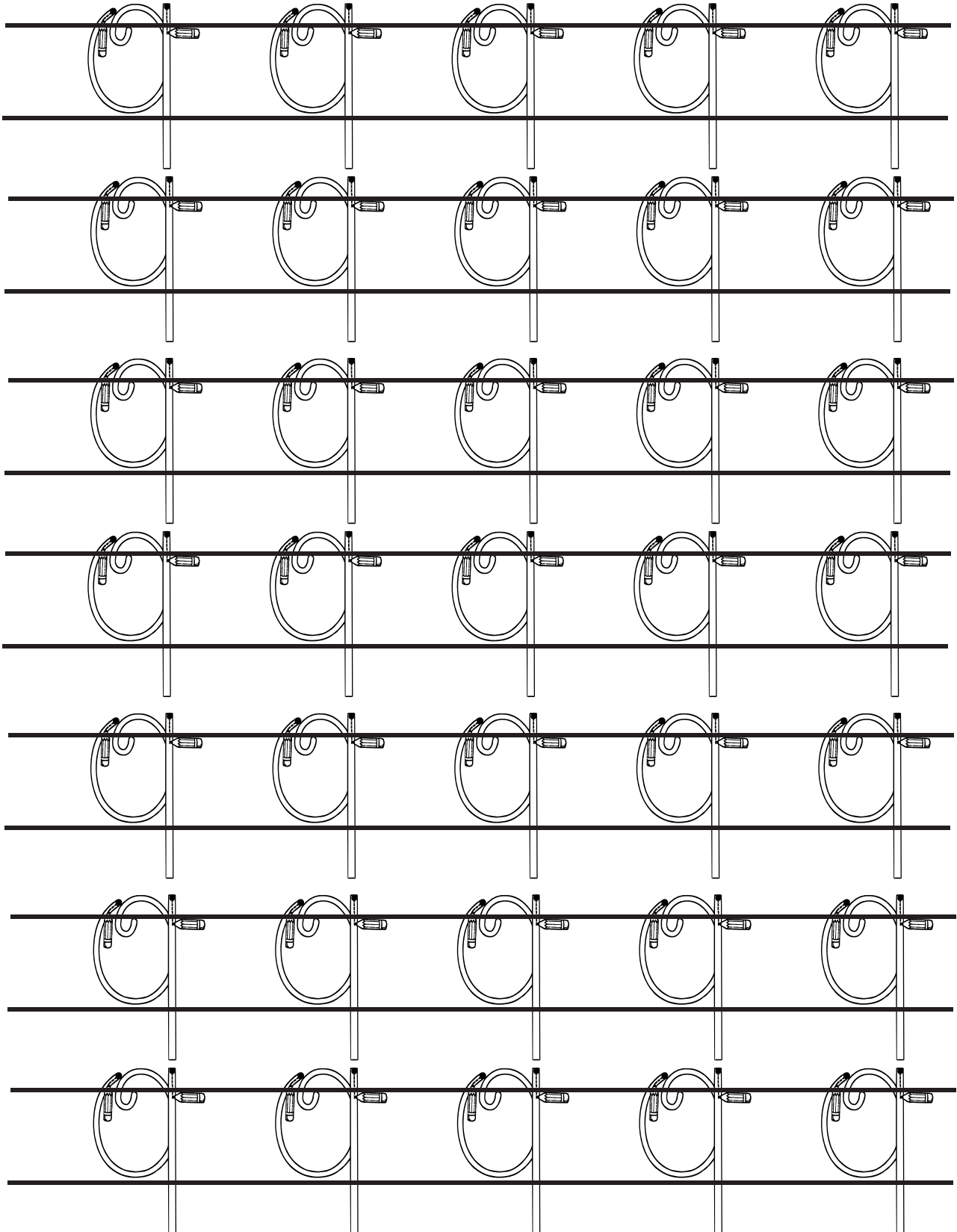

Nom \_\_\_\_\_

Date \_\_\_\_\_

## Ecris la lettre Q/q

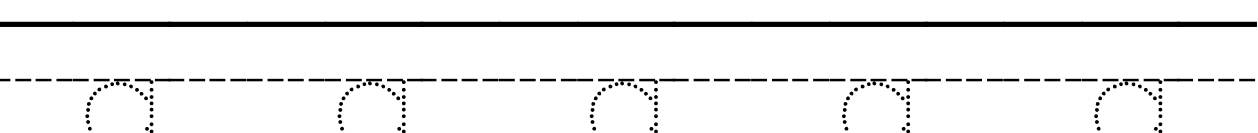
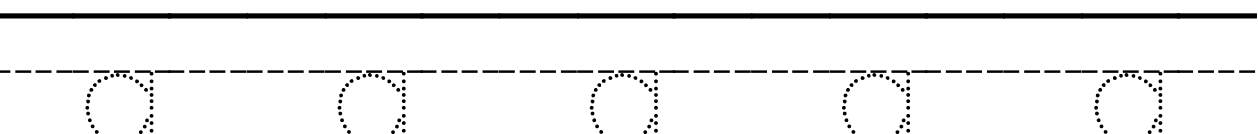
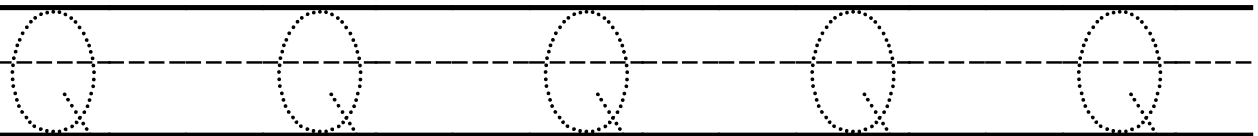
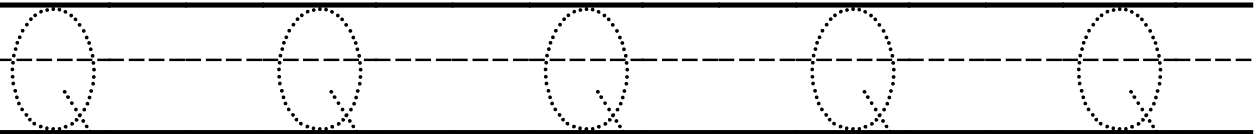
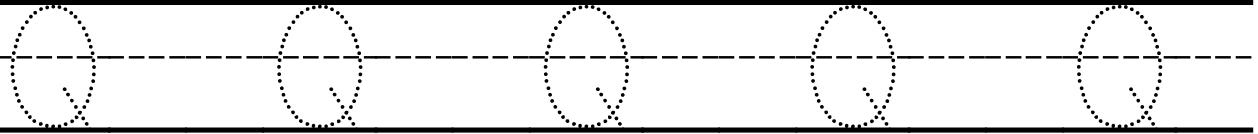
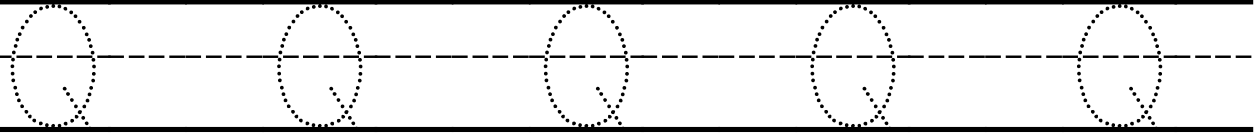

Nom \_\_\_\_\_ Date \_\_\_\_\_

Ecris la lettre Q/q

Q Q Q Q Q

Handwriting practice lines for uppercase Q. The first row contains five examples of the letter Q. Below are two sets of blank handwriting lines, each consisting of a solid top line, a dashed middle line, and a solid bottom line.

q q q q q

Handwriting practice lines for lowercase q. The first row contains five examples of the letter q. Below are two sets of blank handwriting lines, each consisting of a solid top line, a dashed middle line, and a solid bottom line.

Nom \_\_\_\_\_

Date \_\_\_\_\_

# Colorie la lettre Q

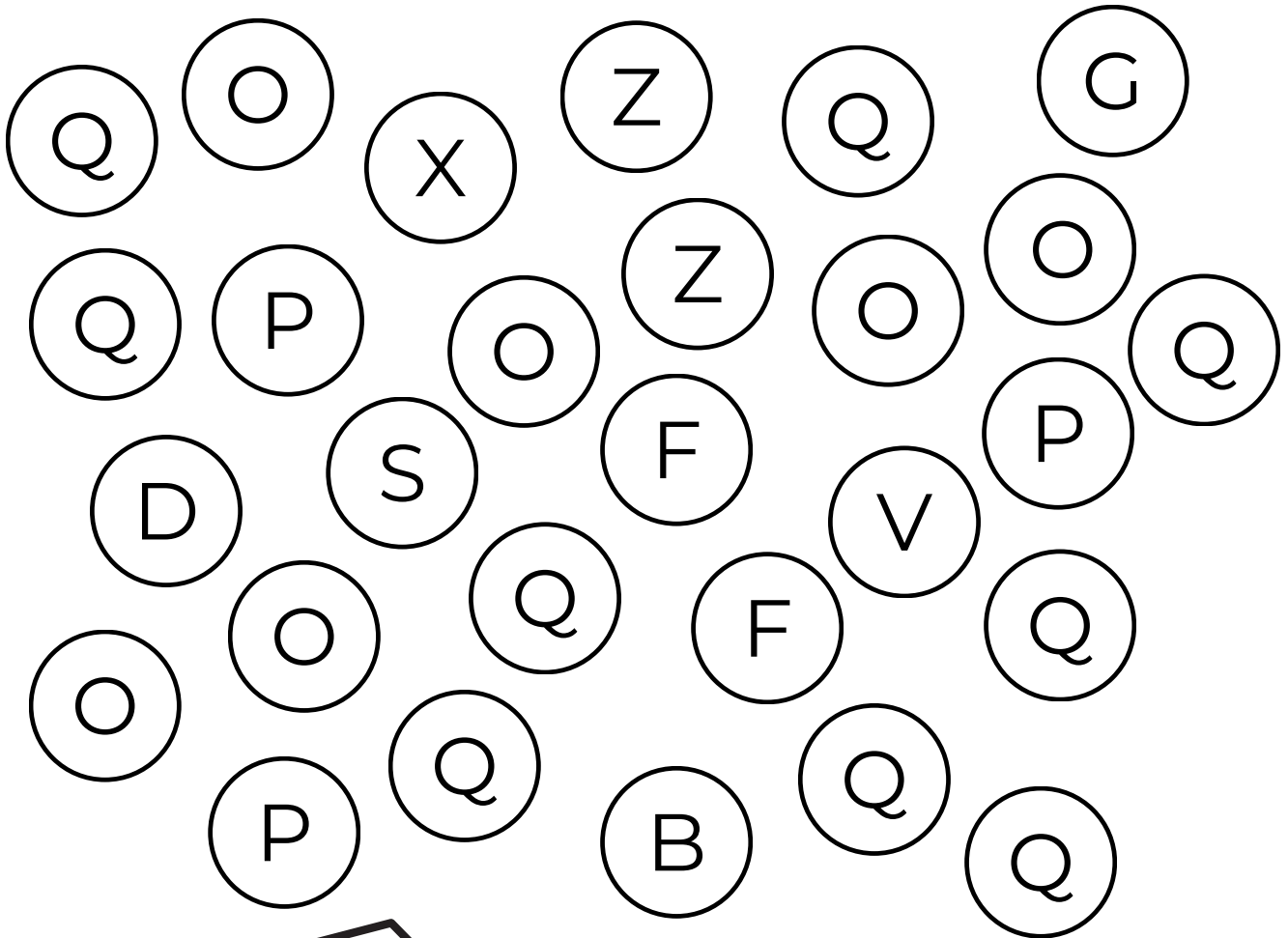

Nom \_\_\_\_\_

Date \_\_\_\_\_

## Colorie la lettre q

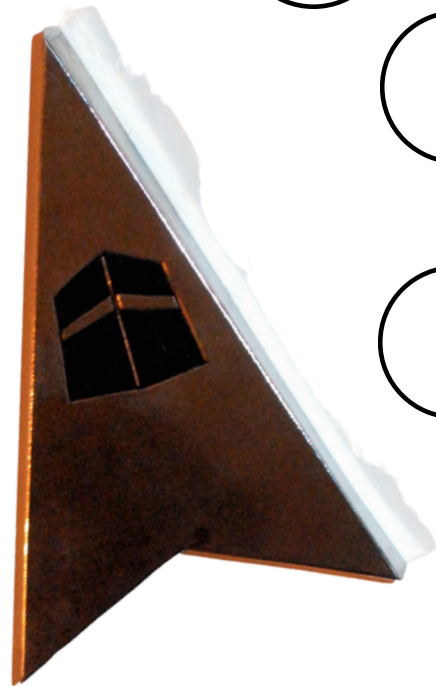
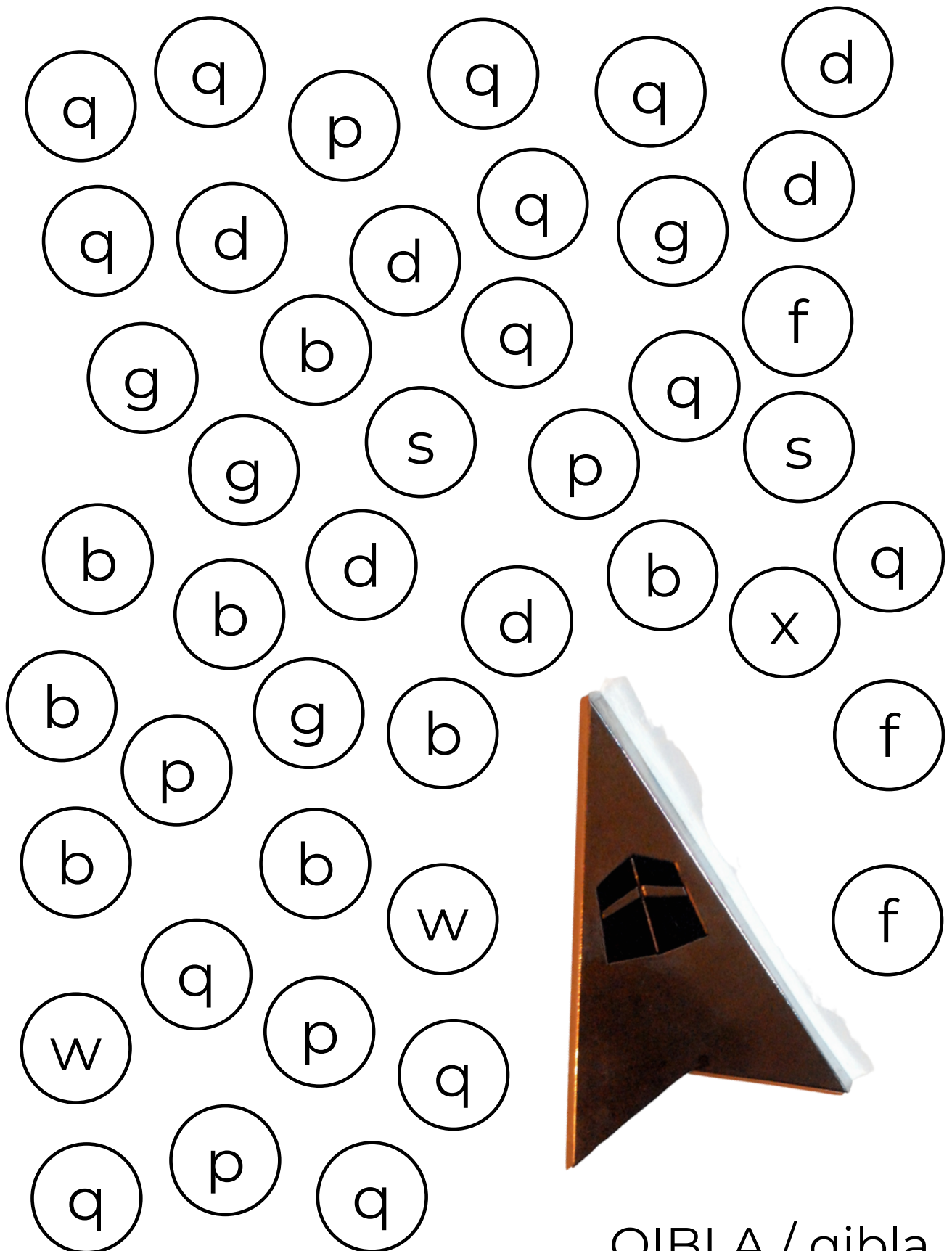

QIBLA / qibla

Nom \_\_\_\_\_

Date \_\_\_\_\_

Repasse sur la lettre R / r

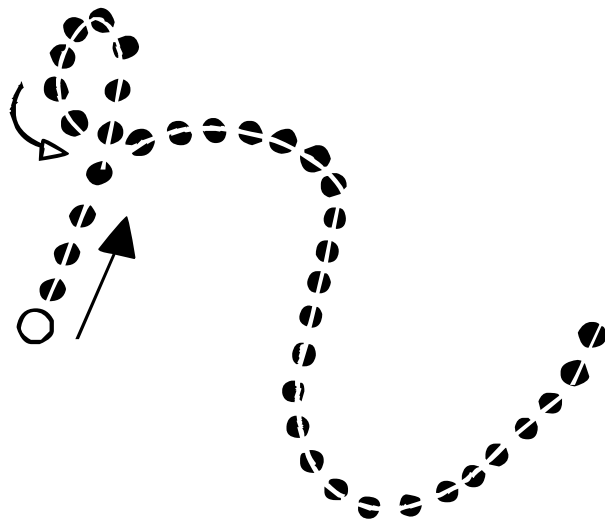

Nom \_\_\_\_\_

Date \_\_\_\_\_

Repasse sur la lettre R / r

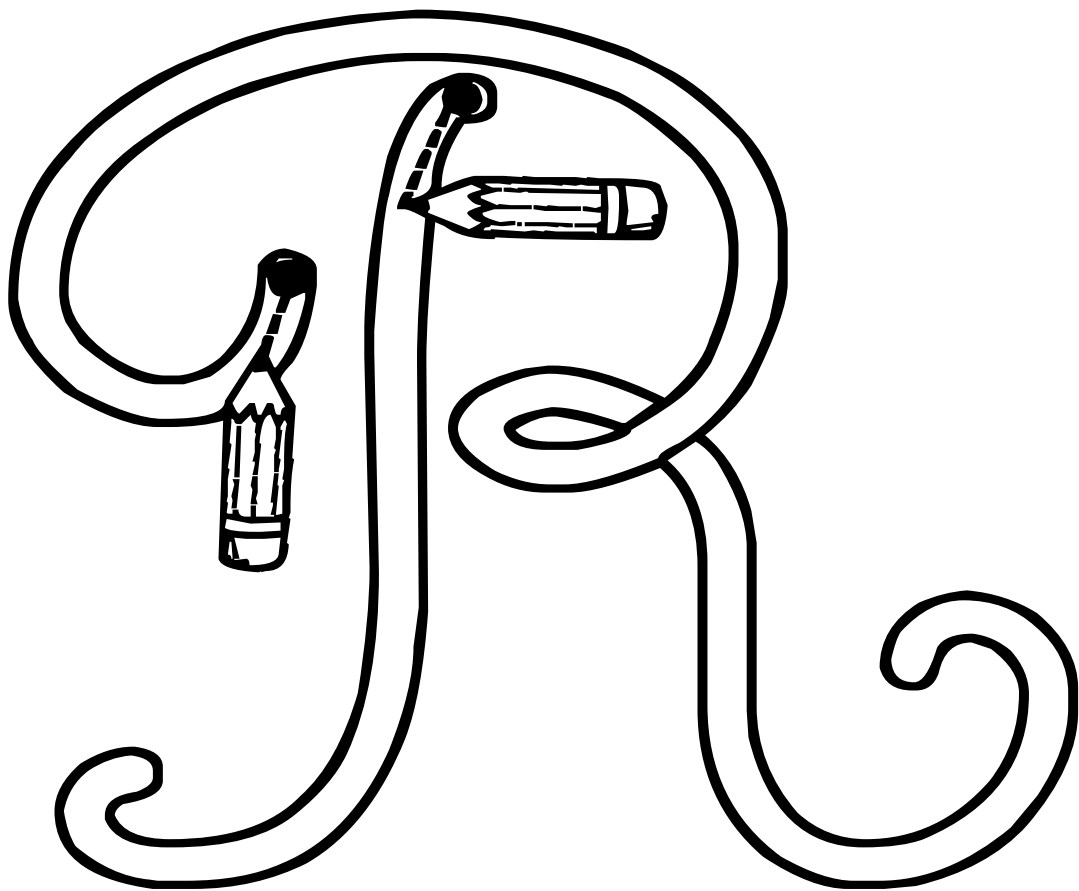

Nom \_\_\_\_\_

Date \_\_\_\_\_

Repasse sur la lettre R / r

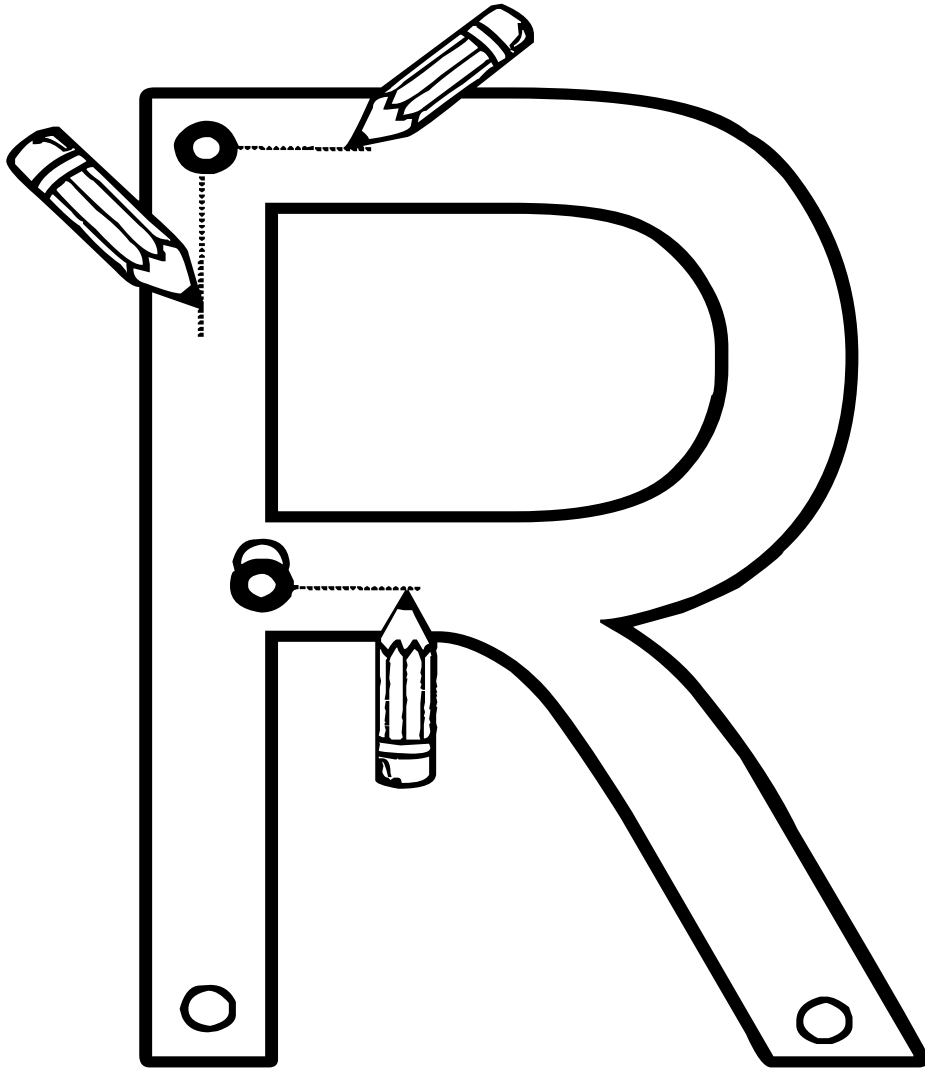

Nom \_\_\_\_\_

Date \_\_\_\_\_

## Ecris la lettre R / r

R R R R R R R

R R R R R R R

R R R R R R R

R R R R R R R

R R R R R R R

R R R R R R R

R R R R R R R

Nom \_\_\_\_\_

Date \_\_\_\_\_

# Ecris la lettre R / r

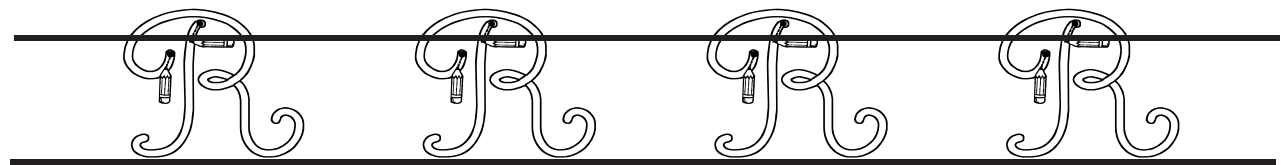
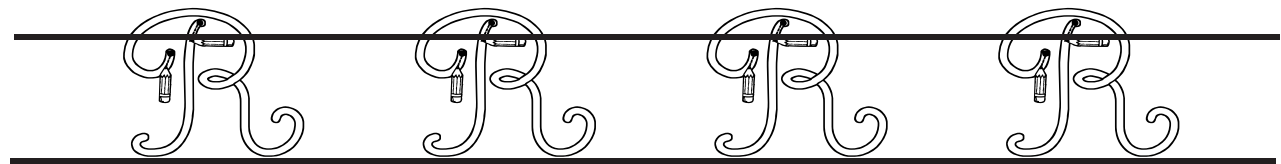
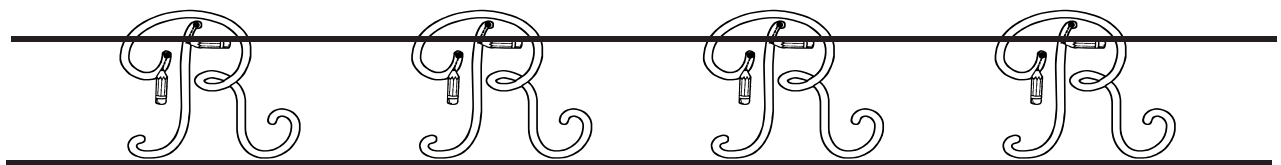
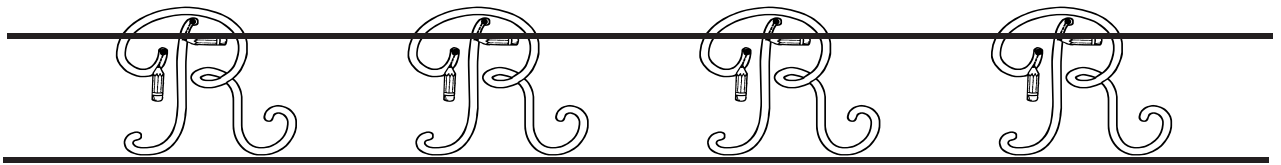
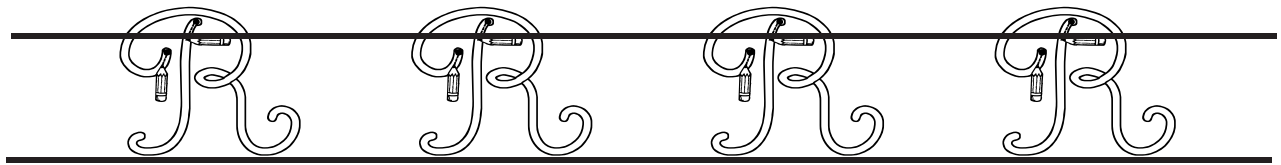
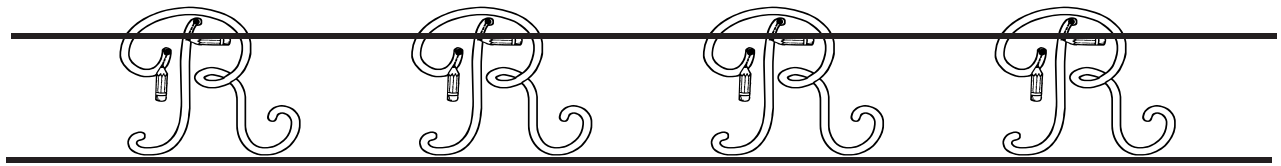
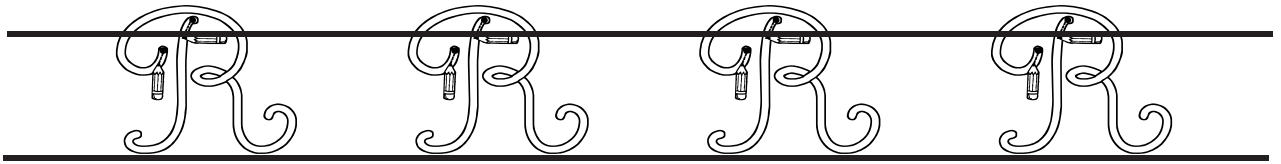

Nom \_\_\_\_\_

Date \_\_\_\_\_

## Ecris la lettre R/r

R R R R R

R R R R R

R R R R R

R R R R R

r r r r r

r r r r r

r r r r r

r r r r r

Nom \_\_\_\_\_ Date \_\_\_\_\_

Ecris la lettre R/r

R R R R R

Handwriting practice lines for uppercase 'R'. Each set consists of a solid top line, a dashed middle line, and a solid bottom line. There are two such sets of lines provided for practice.

r r r r r

Handwriting practice lines for lowercase 'r'. Each set consists of a solid top line, a dashed middle line, and a solid bottom line. There are two such sets of lines provided for practice.

Nom \_\_\_\_\_

Date \_\_\_\_\_

## Colorie la lettre R

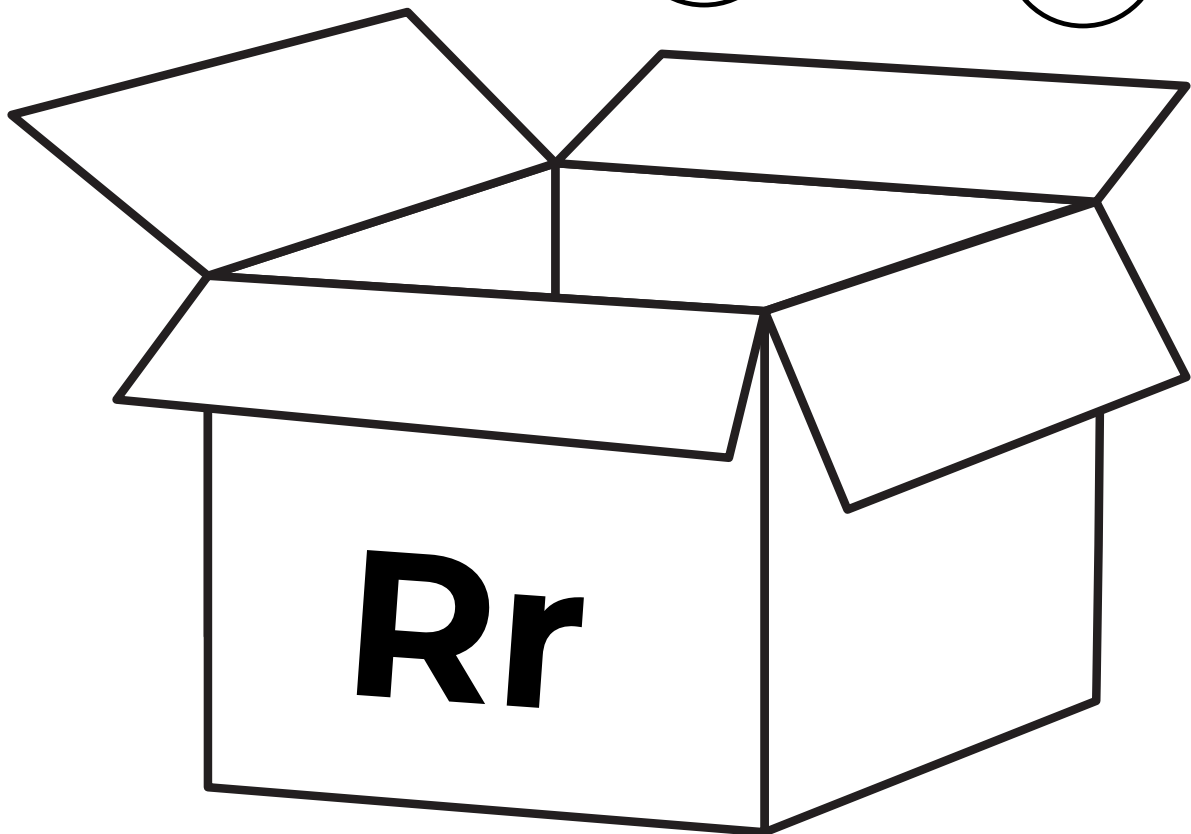
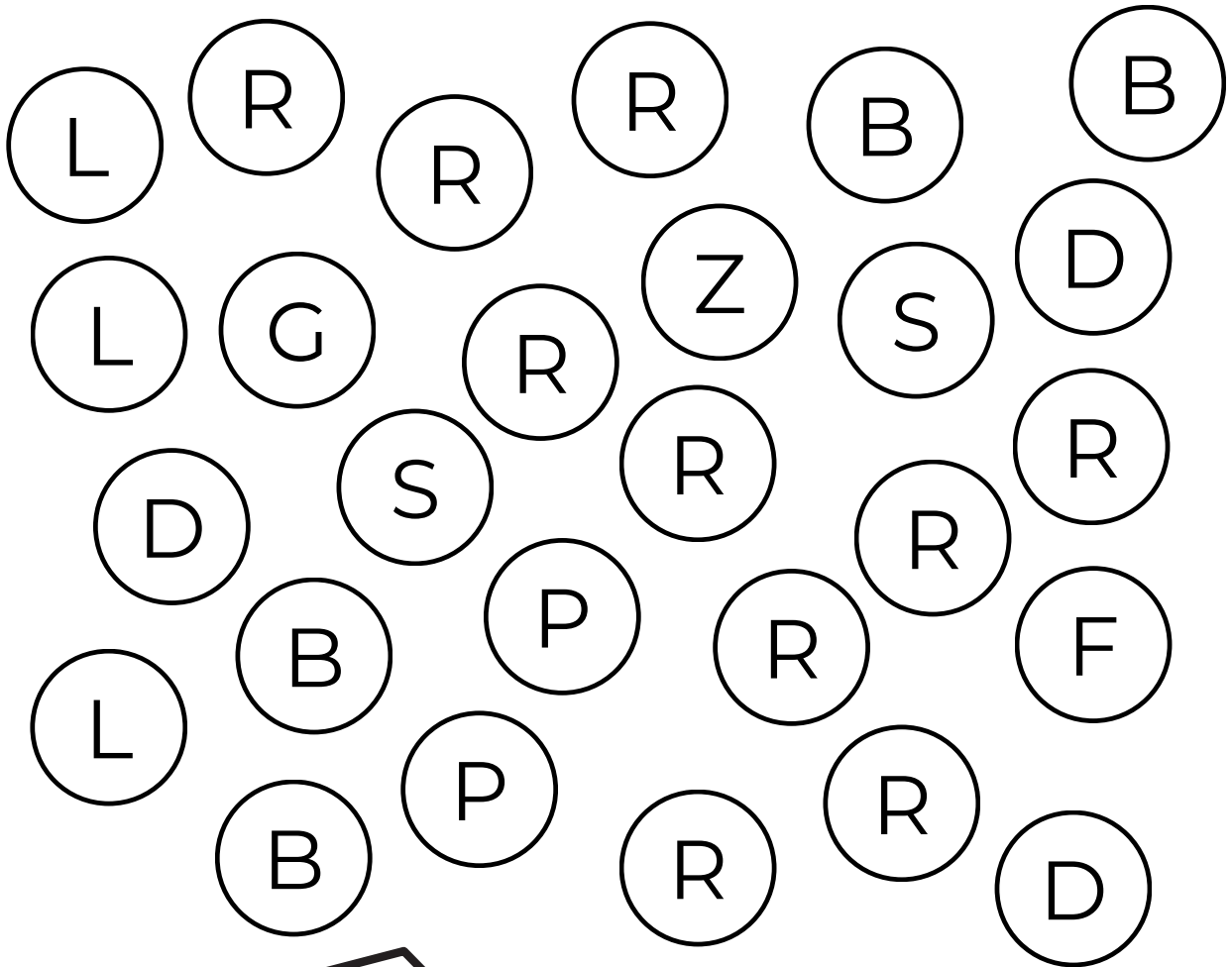

Nom \_\_\_\_\_

Date \_\_\_\_\_

## Colorie la lettre r

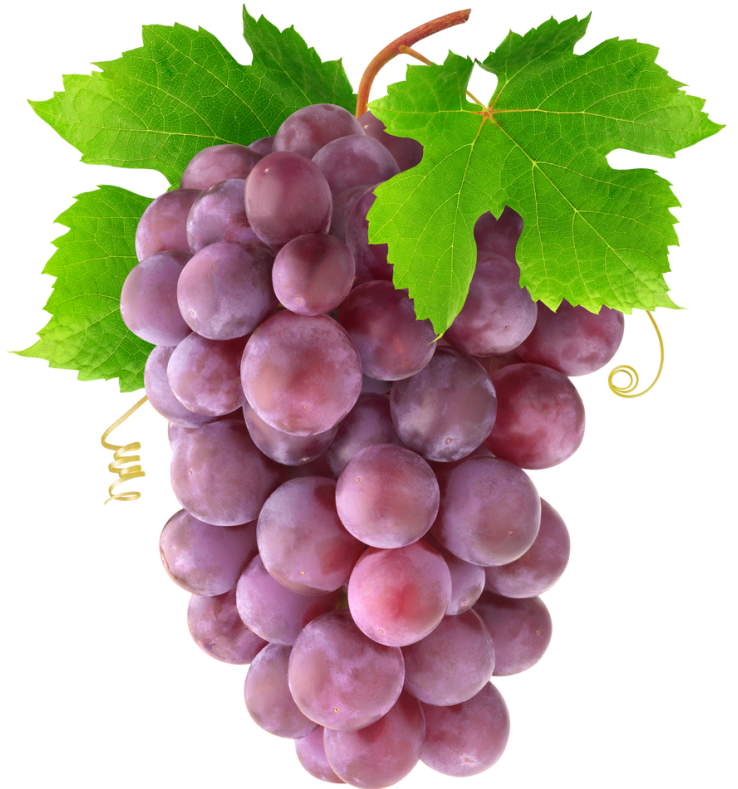
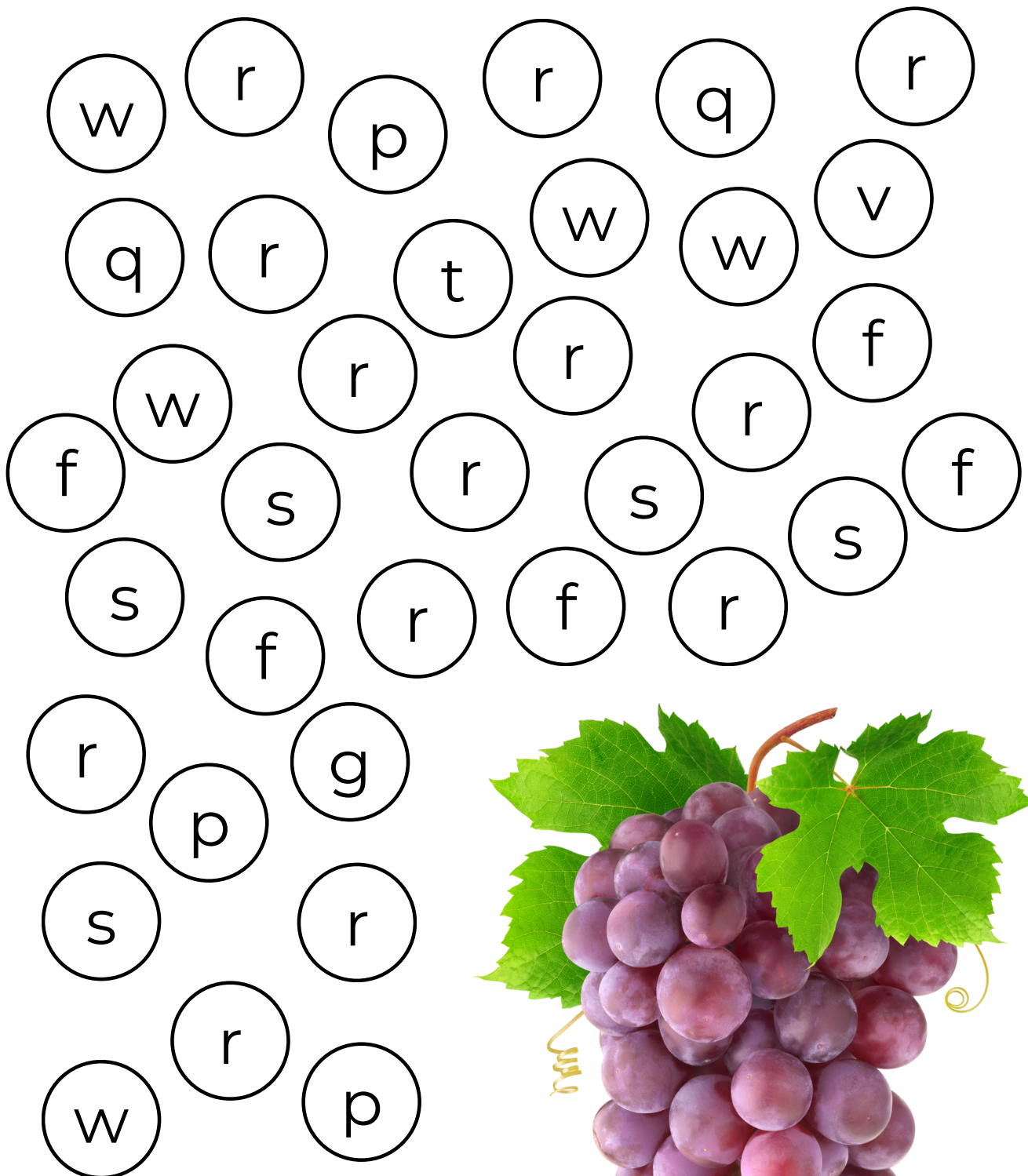

RAISIN / raisin

Nom \_\_\_\_\_

Date \_\_\_\_\_

# Repasse sur la lettre S / s

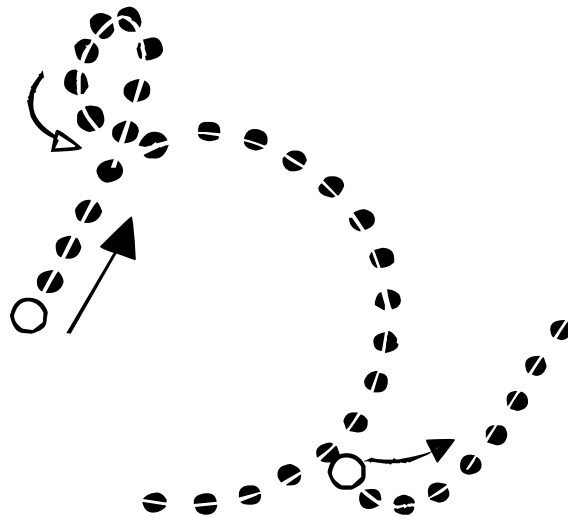

Nom \_\_\_\_\_

Date \_\_\_\_\_

Repasse sur la lettre S / s

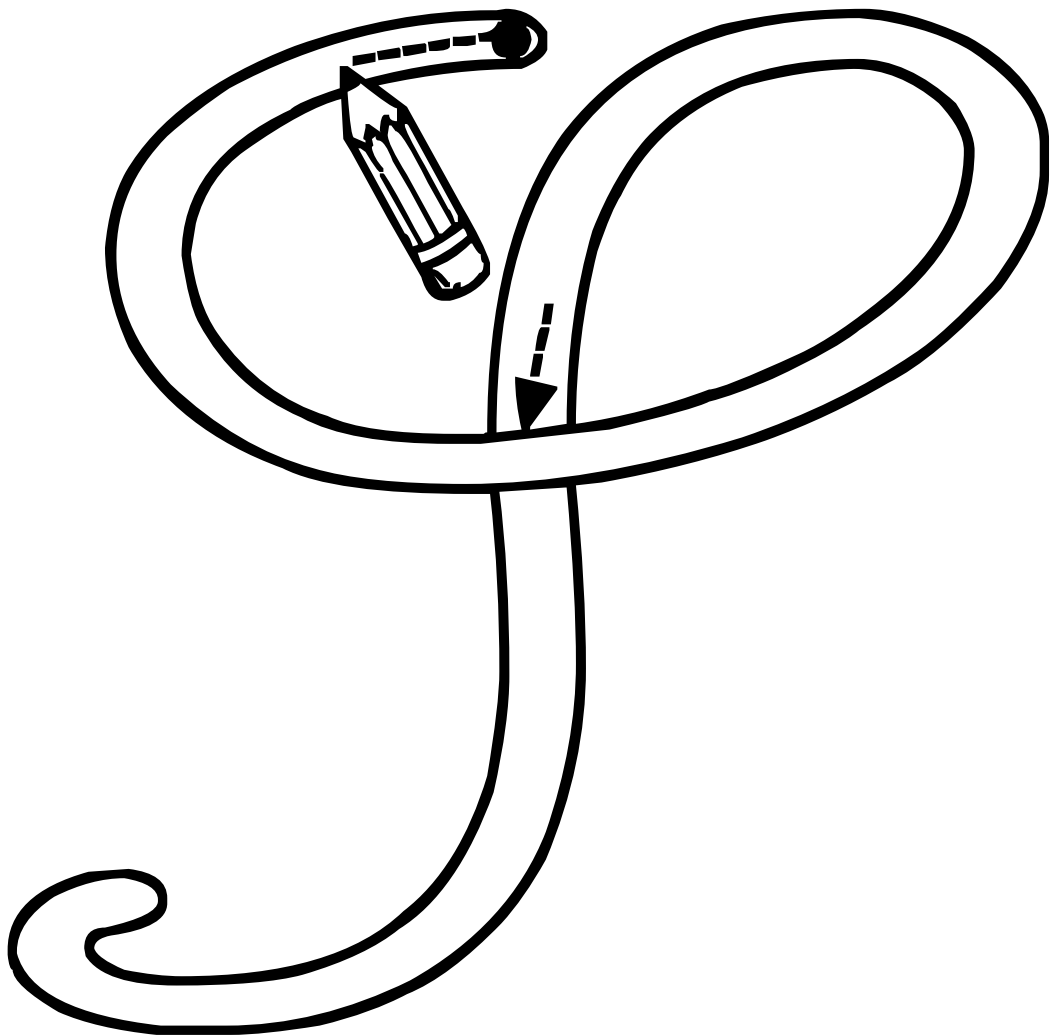

Nom \_\_\_\_\_

Date \_\_\_\_\_

Repasse sur la lettre S / s

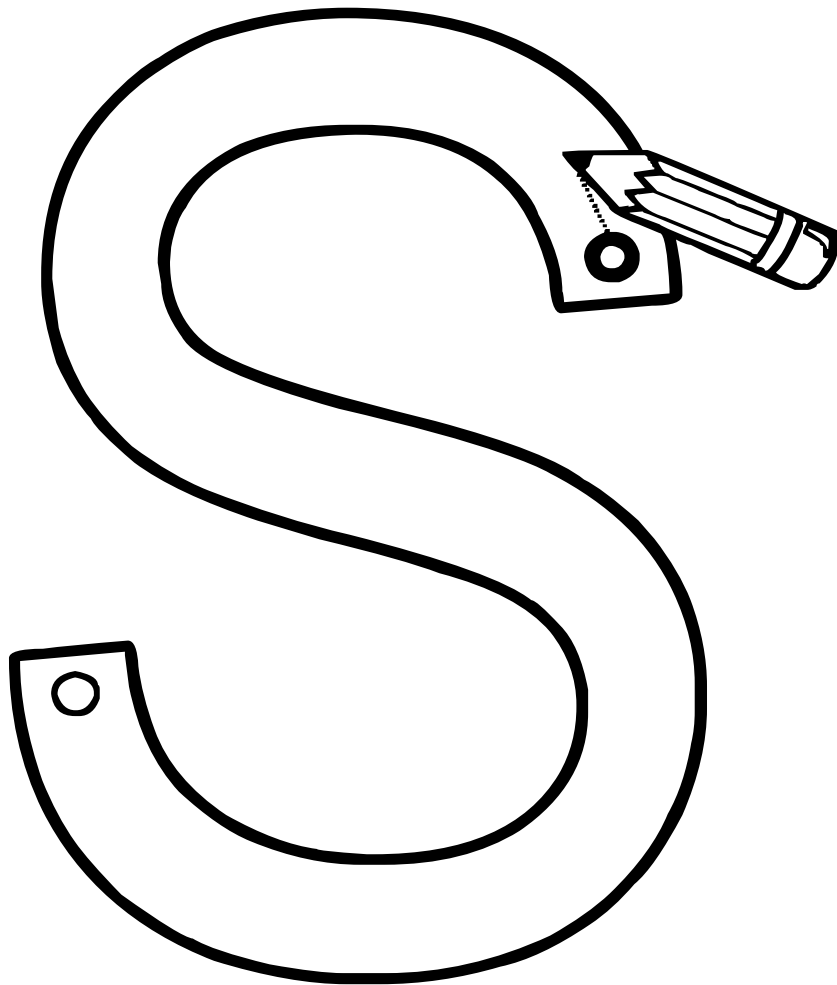

Nom \_\_\_\_\_

Date \_\_\_\_\_

# Ecris la lettre S / s



Nom \_\_\_\_\_

Date \_\_\_\_\_

# Ecris la lettre S / s

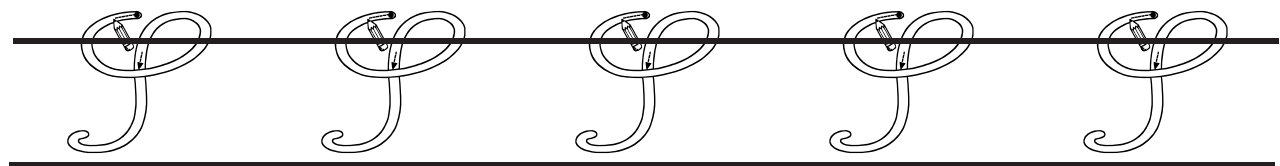
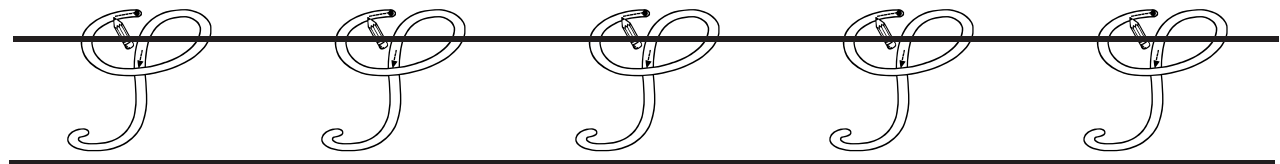
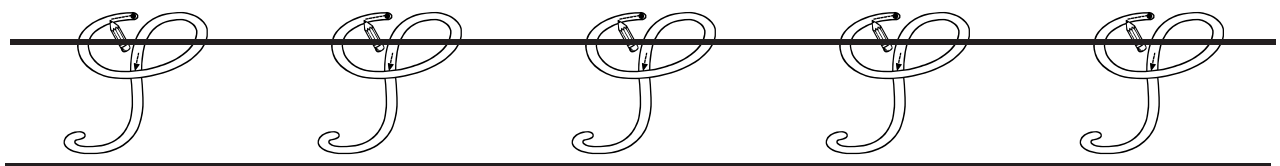
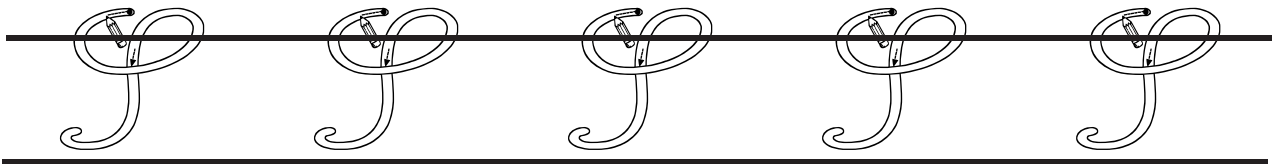
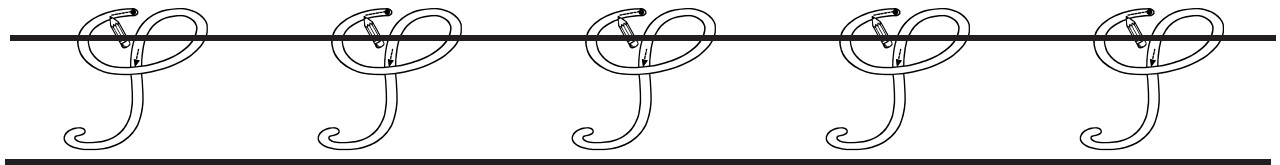
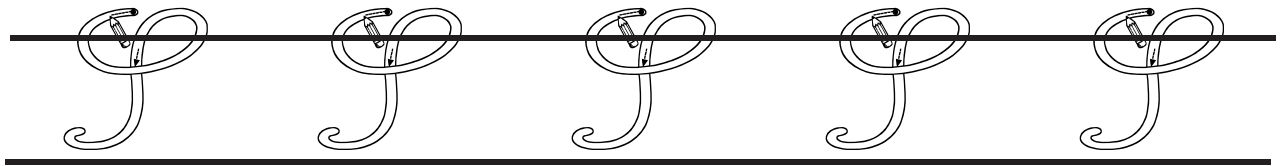
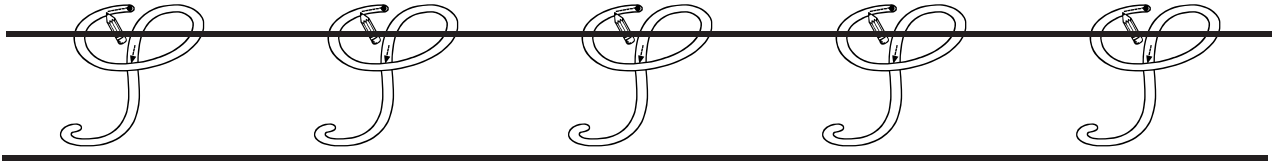

Nom \_\_\_\_\_ Date \_\_\_\_\_

## Ecris la lettre S/s

S S S S S

S S S S S

S S S S S

S S S S S

s s s s s

s s s s s

s s s s s

s s s s s

Nom \_\_\_\_\_ Date \_\_\_\_\_

Ecris la lettre S/s

S S S S S

Handwriting practice lines for uppercase 'S'. Each row consists of a solid top line, a dashed middle line, and a solid bottom line. There are two such rows provided for practice.

s s s s s

Handwriting practice lines for lowercase 's'. Each row consists of a solid top line, a dashed middle line, and a solid bottom line. There are two such rows provided for practice.

Nom \_\_\_\_\_

Date \_\_\_\_\_

## Colorie la lettre S

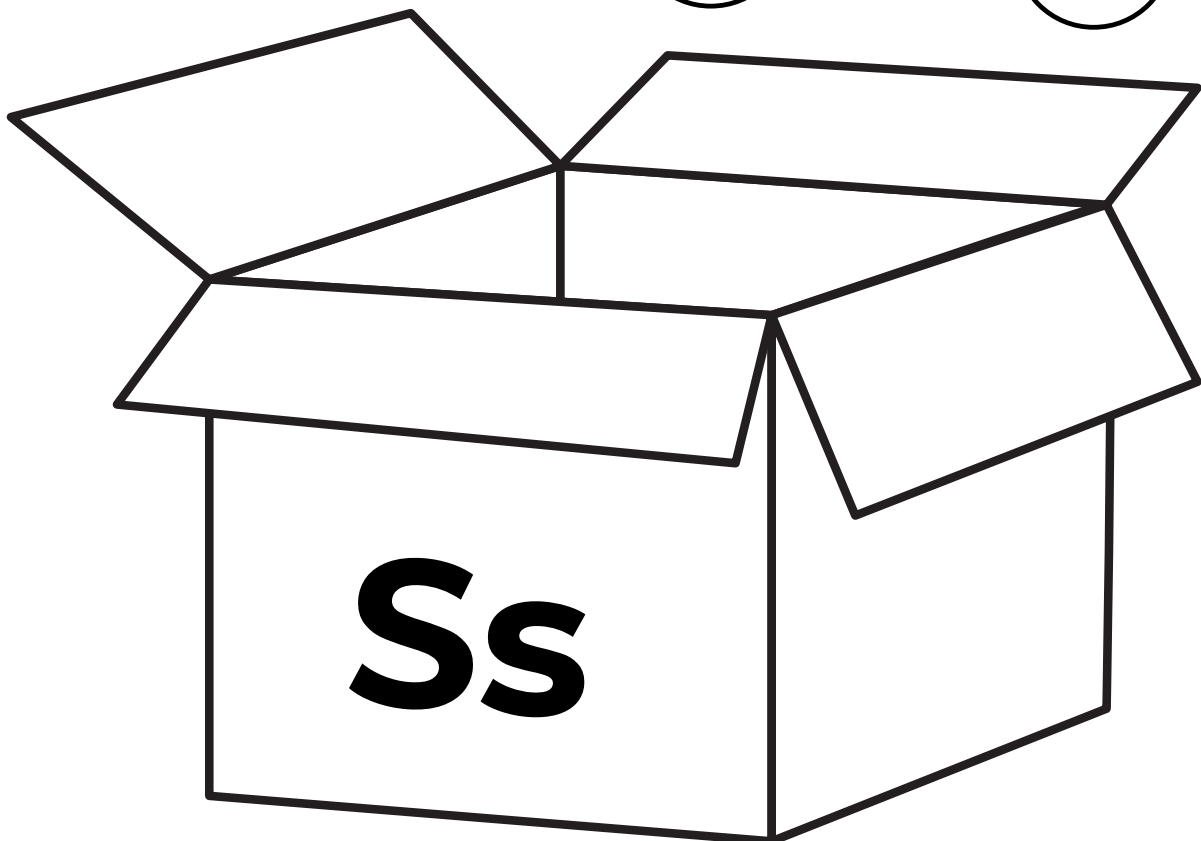
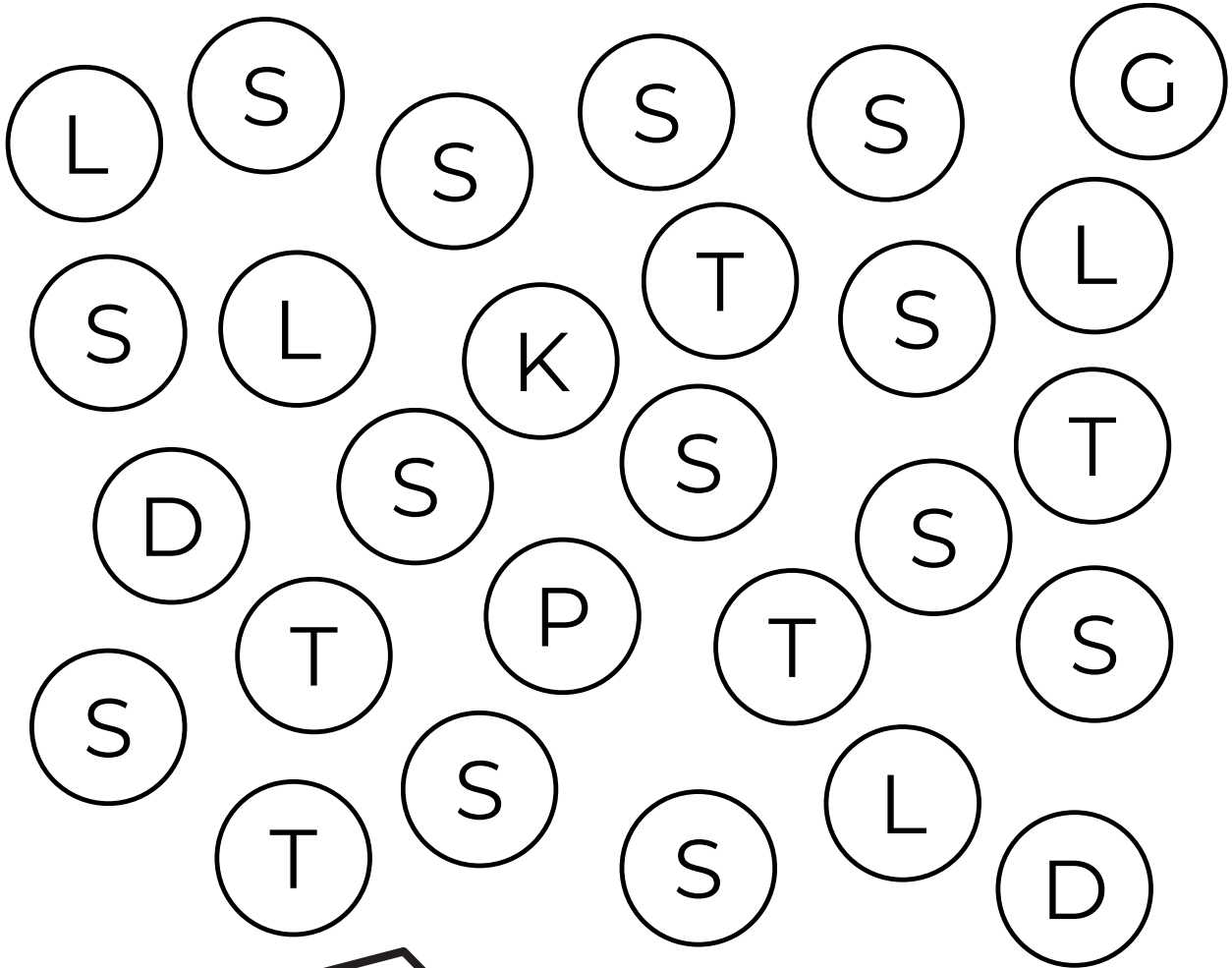

Nom \_\_\_\_\_

Date \_\_\_\_\_

## Colorie la lettre s

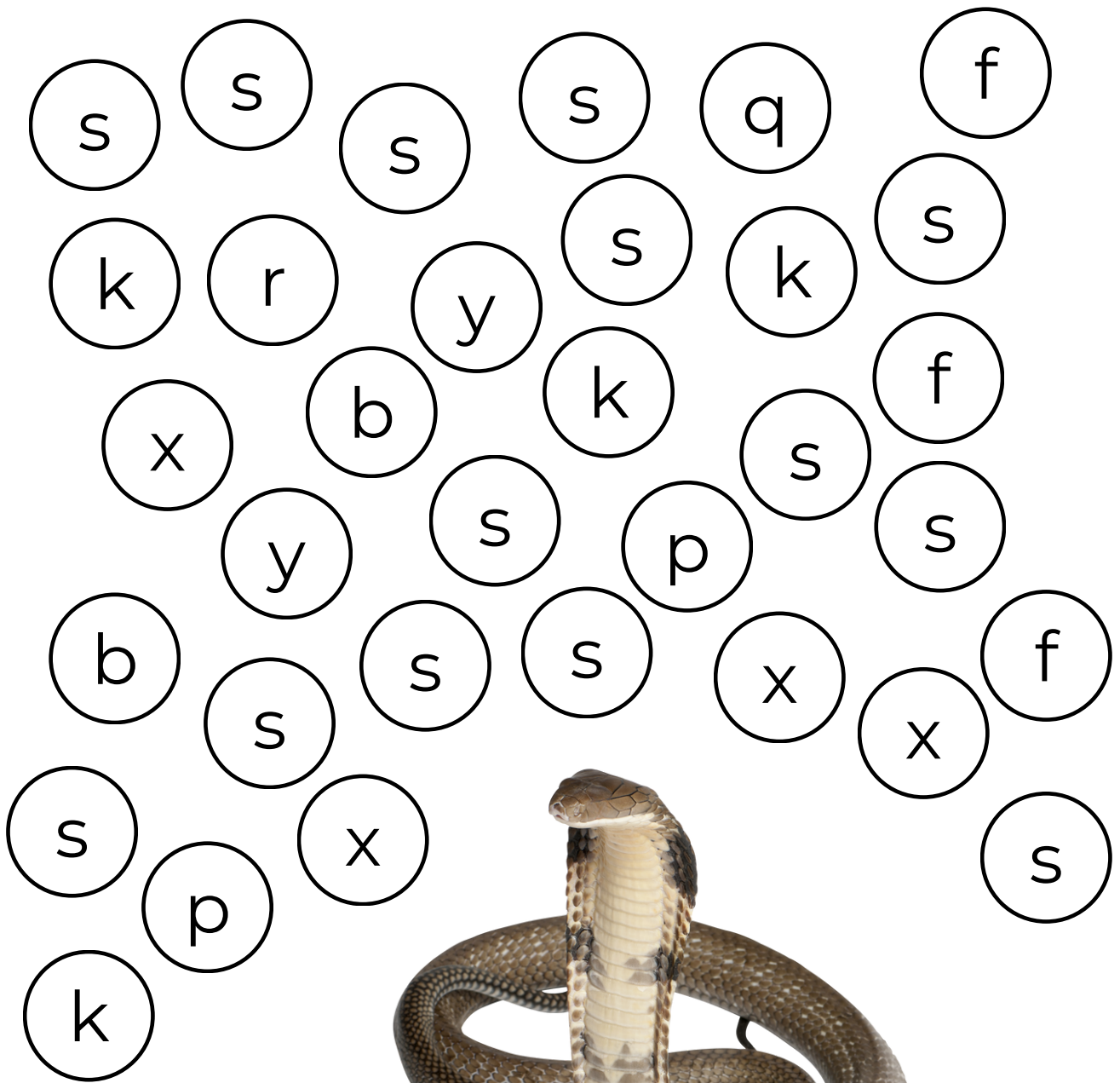

SERPENT / serpent

Nom \_\_\_\_\_

Date \_\_\_\_\_

Repasse sur la lettre T / t

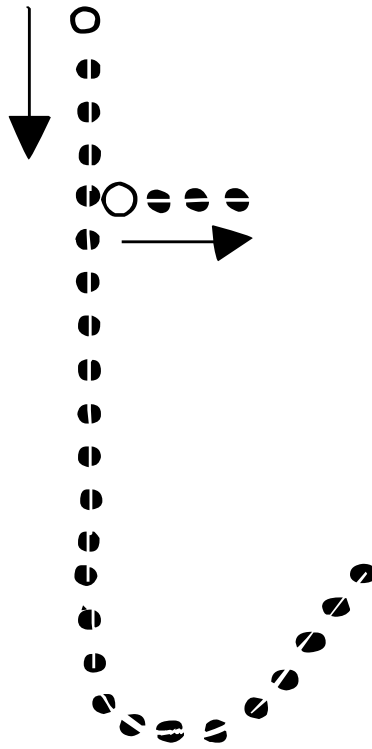

Nom \_\_\_\_\_

Date \_\_\_\_\_

Repasse sur la lettre T / t

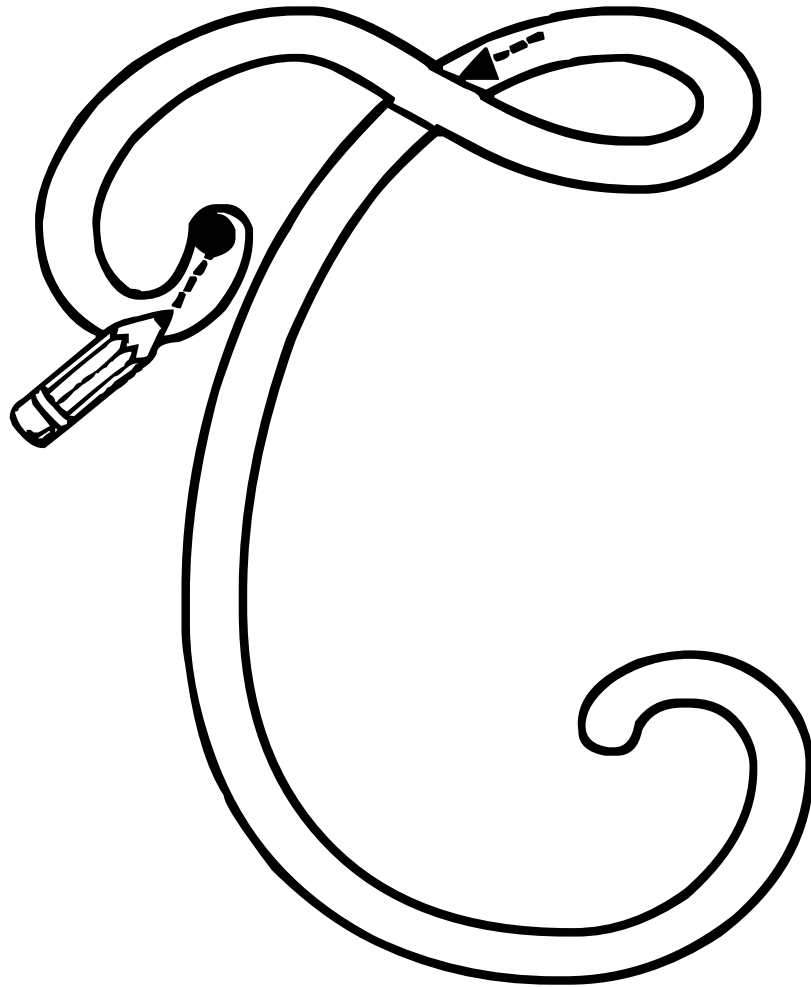

Nom \_\_\_\_\_

Date \_\_\_\_\_

Repasse sur la lettre T / t

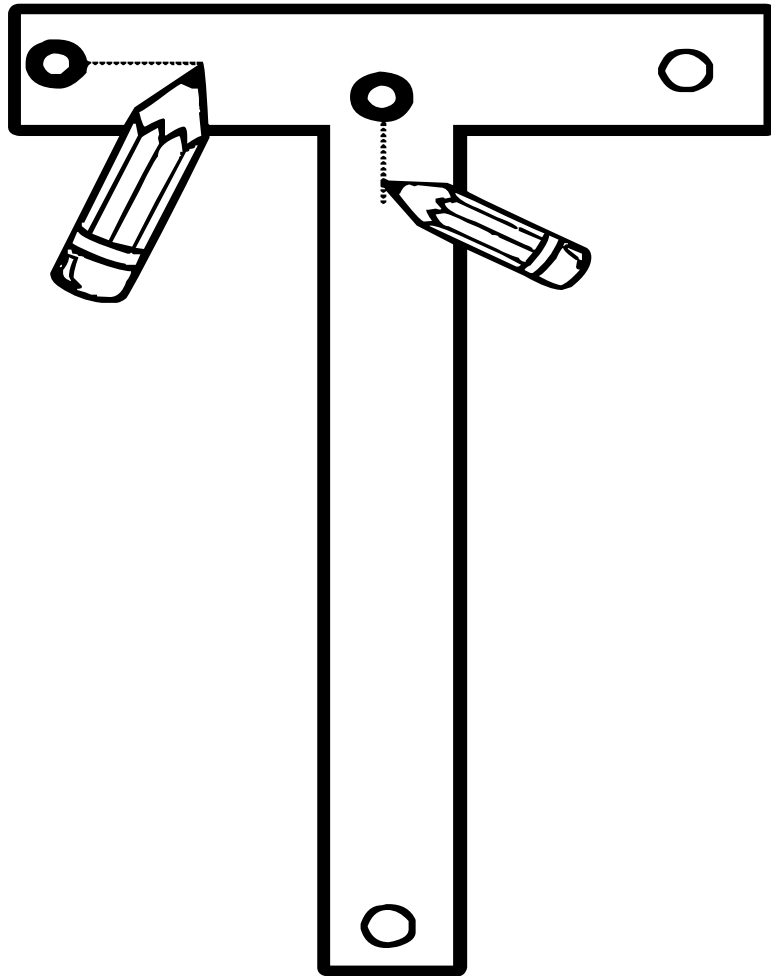

Nom \_\_\_\_\_

Date \_\_\_\_\_

# Ecris la lettre T / t

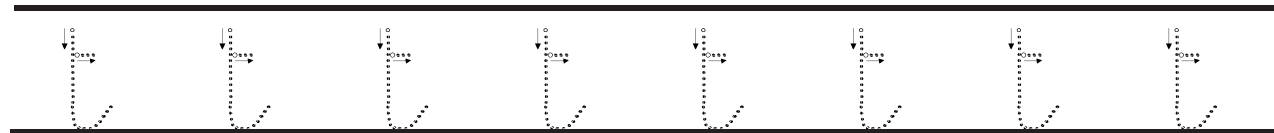
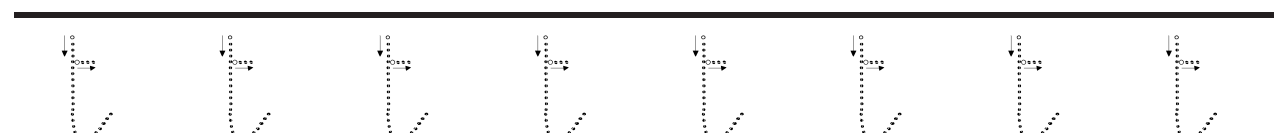
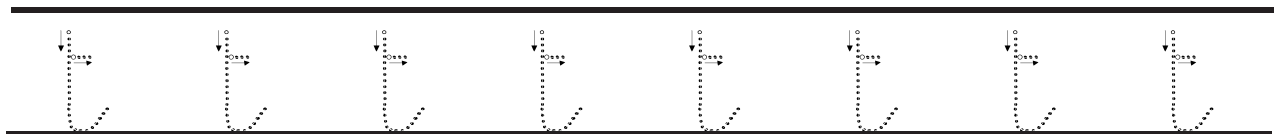
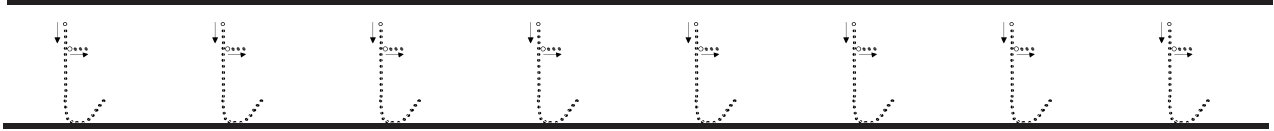
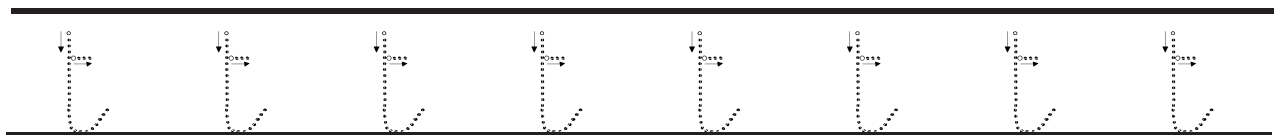
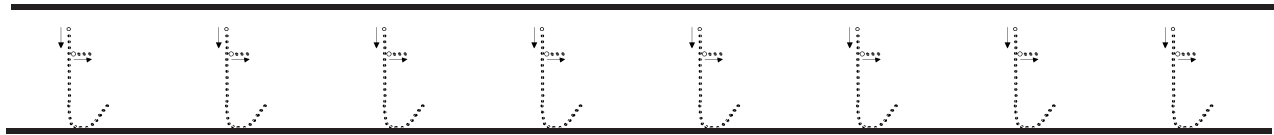
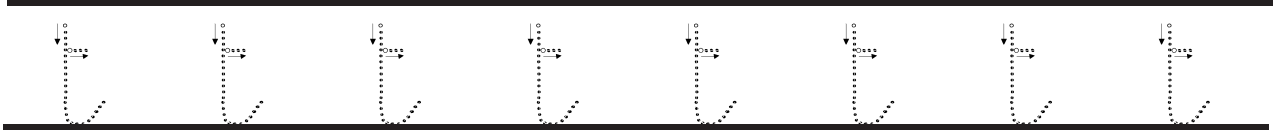

Nom \_\_\_\_\_

Date \_\_\_\_\_

# Ecris la lettre T / t

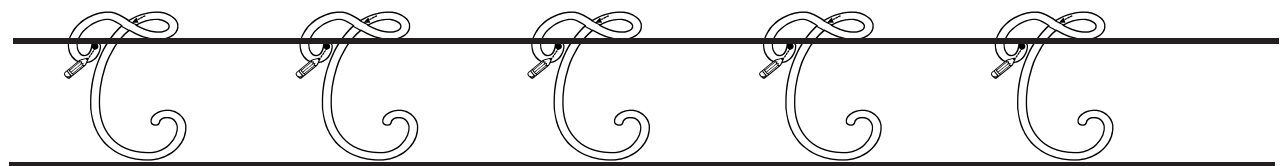
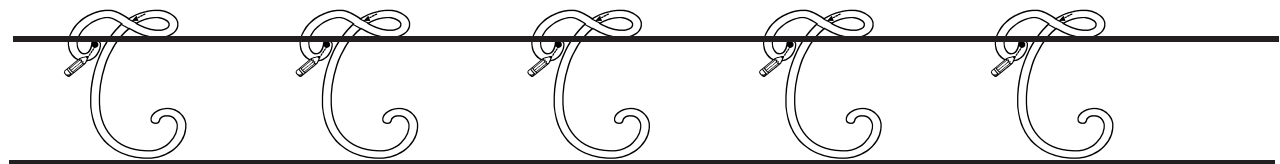
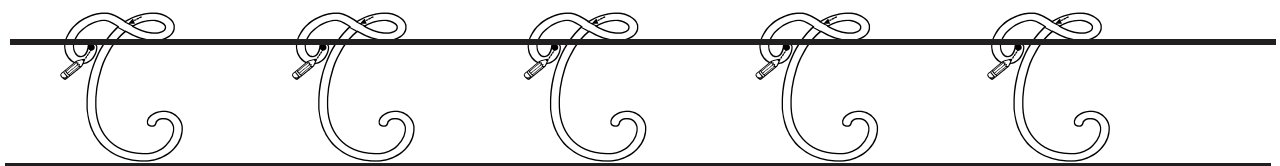
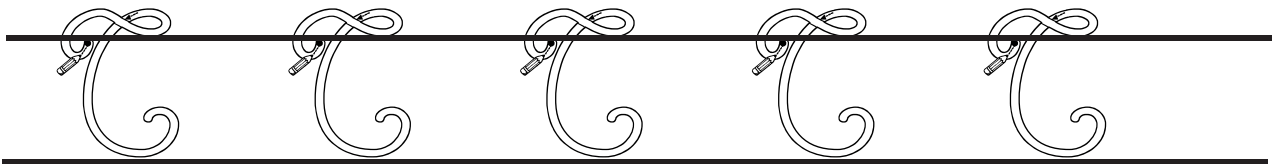
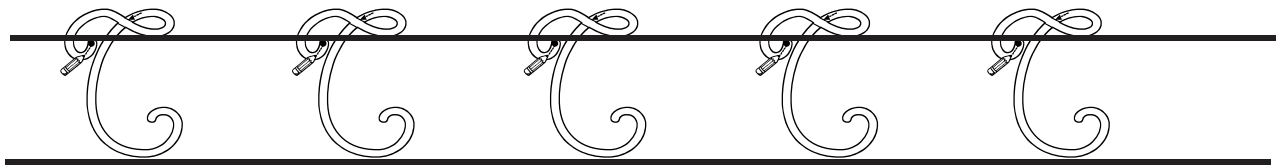
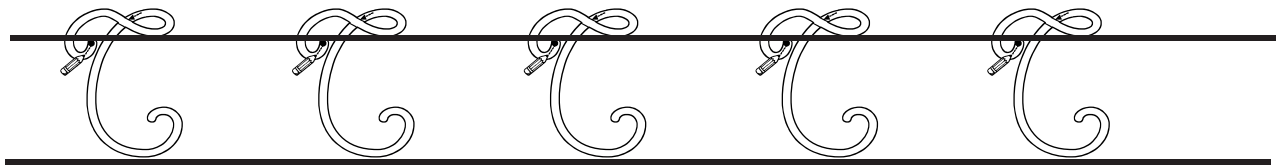
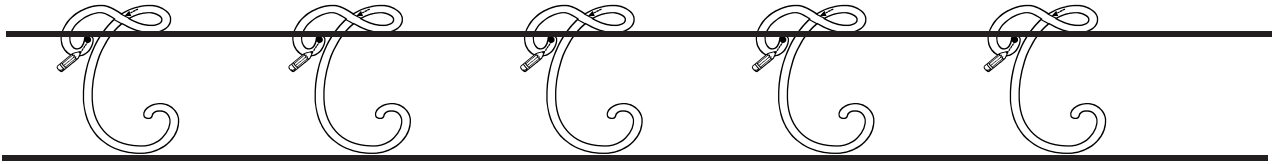

Nom \_\_\_\_\_

Date \_\_\_\_\_

# Ecris la lettre T/t

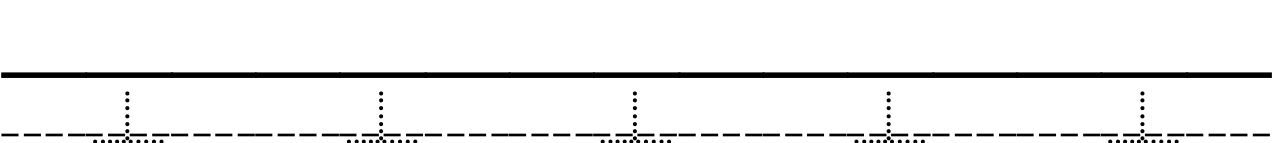
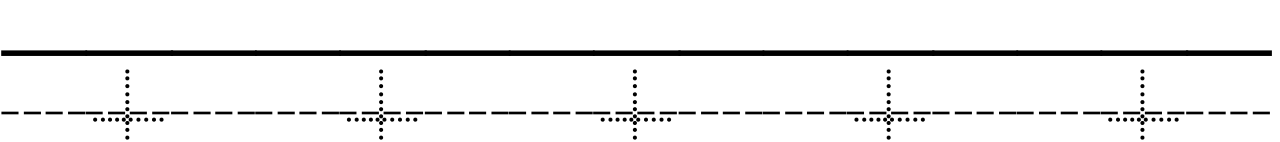
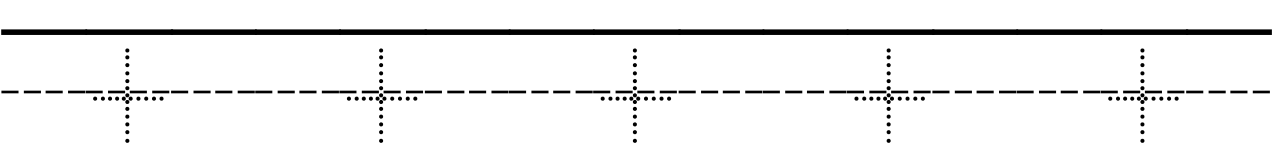
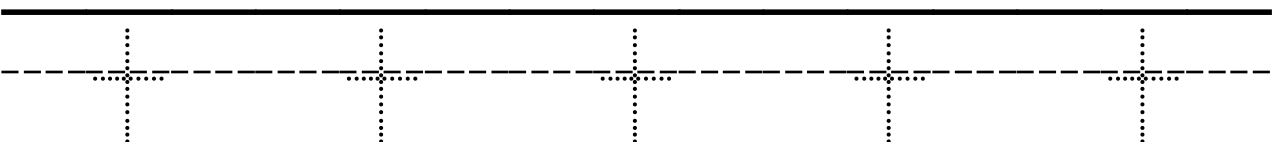
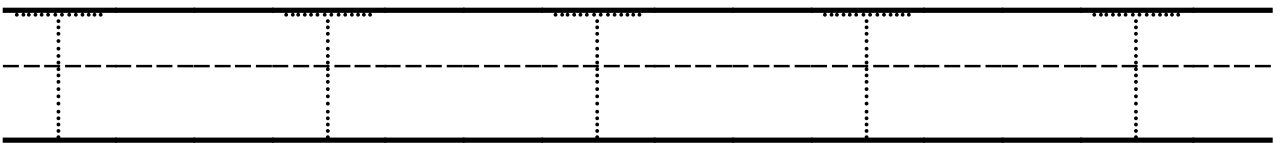
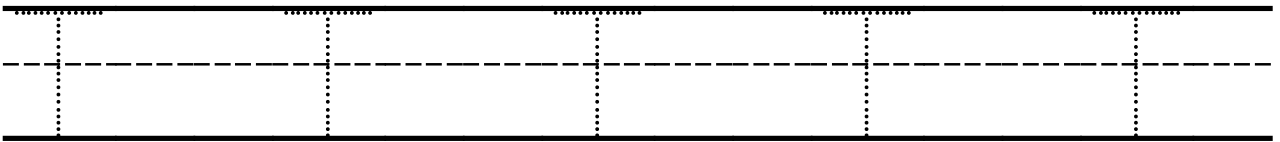
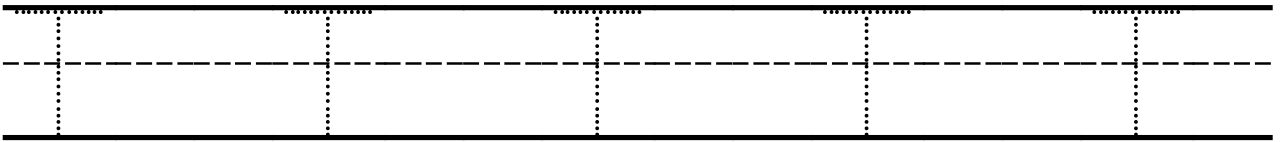
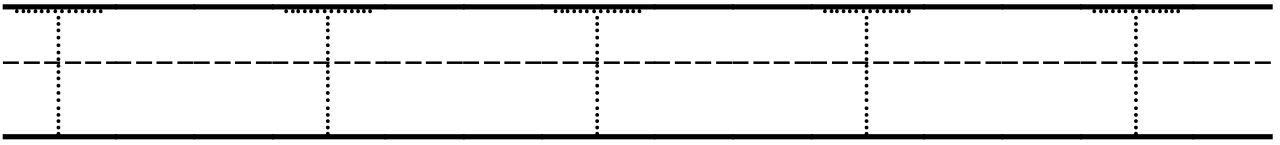

Nom \_\_\_\_\_ Date \_\_\_\_\_

Ecris la lettre T/t

T T T T T

Handwriting practice lines for uppercase letter T. The first set of lines is a solid top line, a dashed middle line, and a solid bottom line. The second set of lines is a solid top line, a dashed middle line, and a solid bottom line.

t t t t t

Handwriting practice lines for lowercase letter t. The first set of lines is a solid top line, a dashed middle line, and a solid bottom line. The second set of lines is a solid top line, a dashed middle line, and a solid bottom line.

Nom \_\_\_\_\_

Date \_\_\_\_\_

## Colorie la lettre T

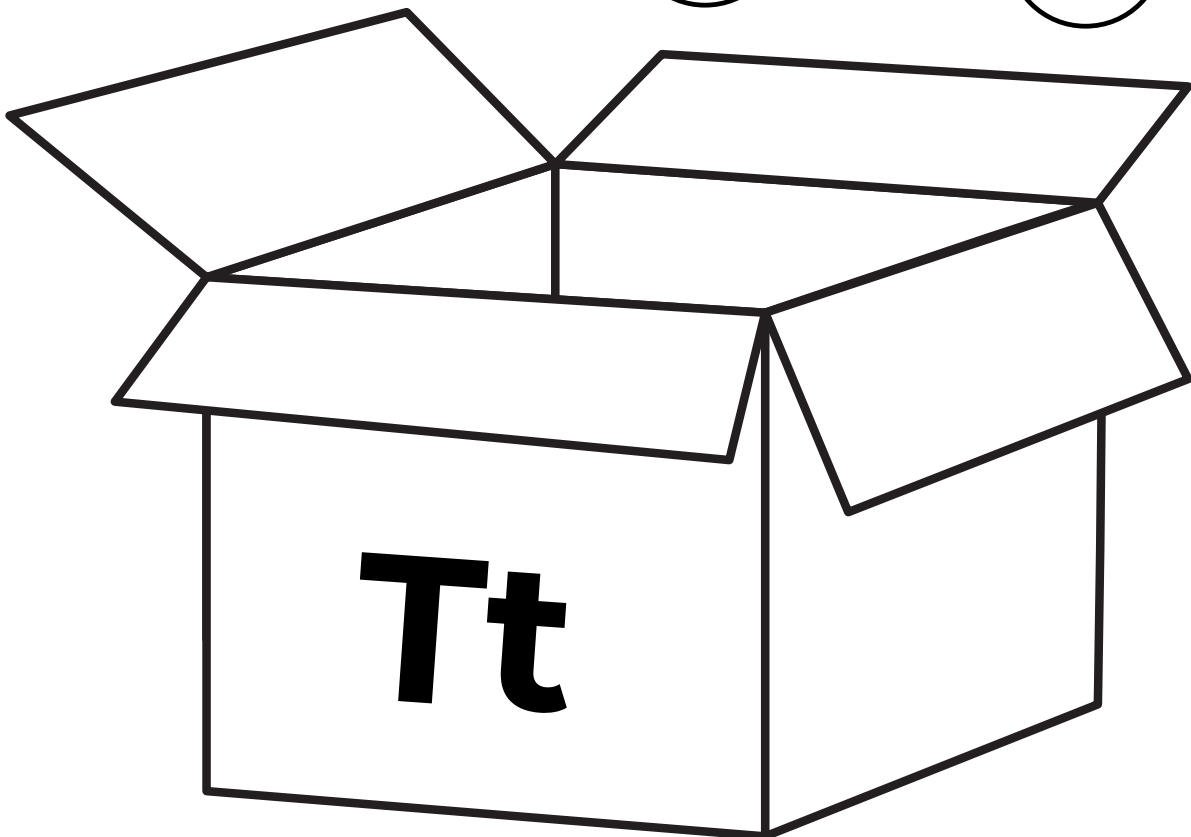
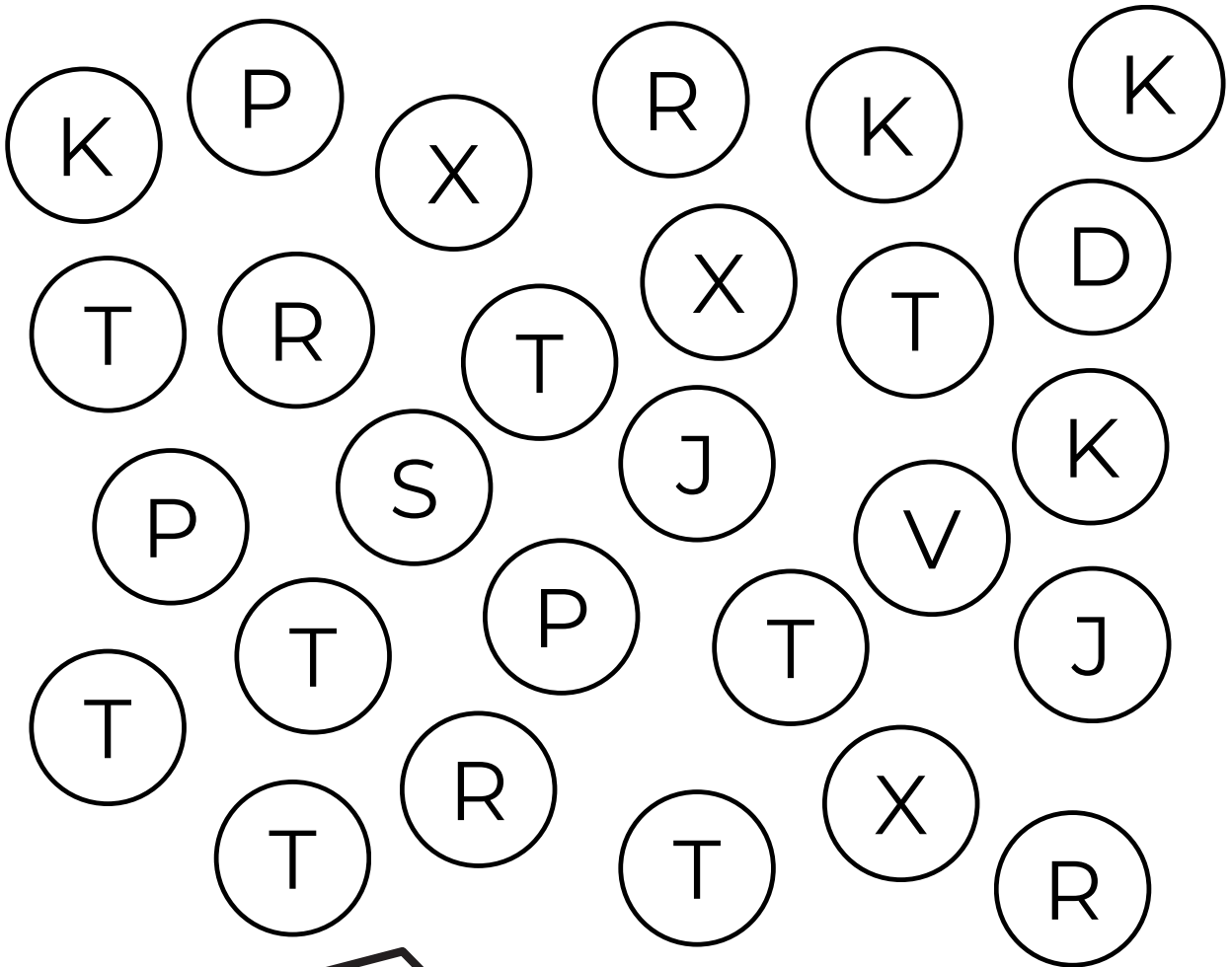

Nom \_\_\_\_\_

Date \_\_\_\_\_

Colorie la lettre t

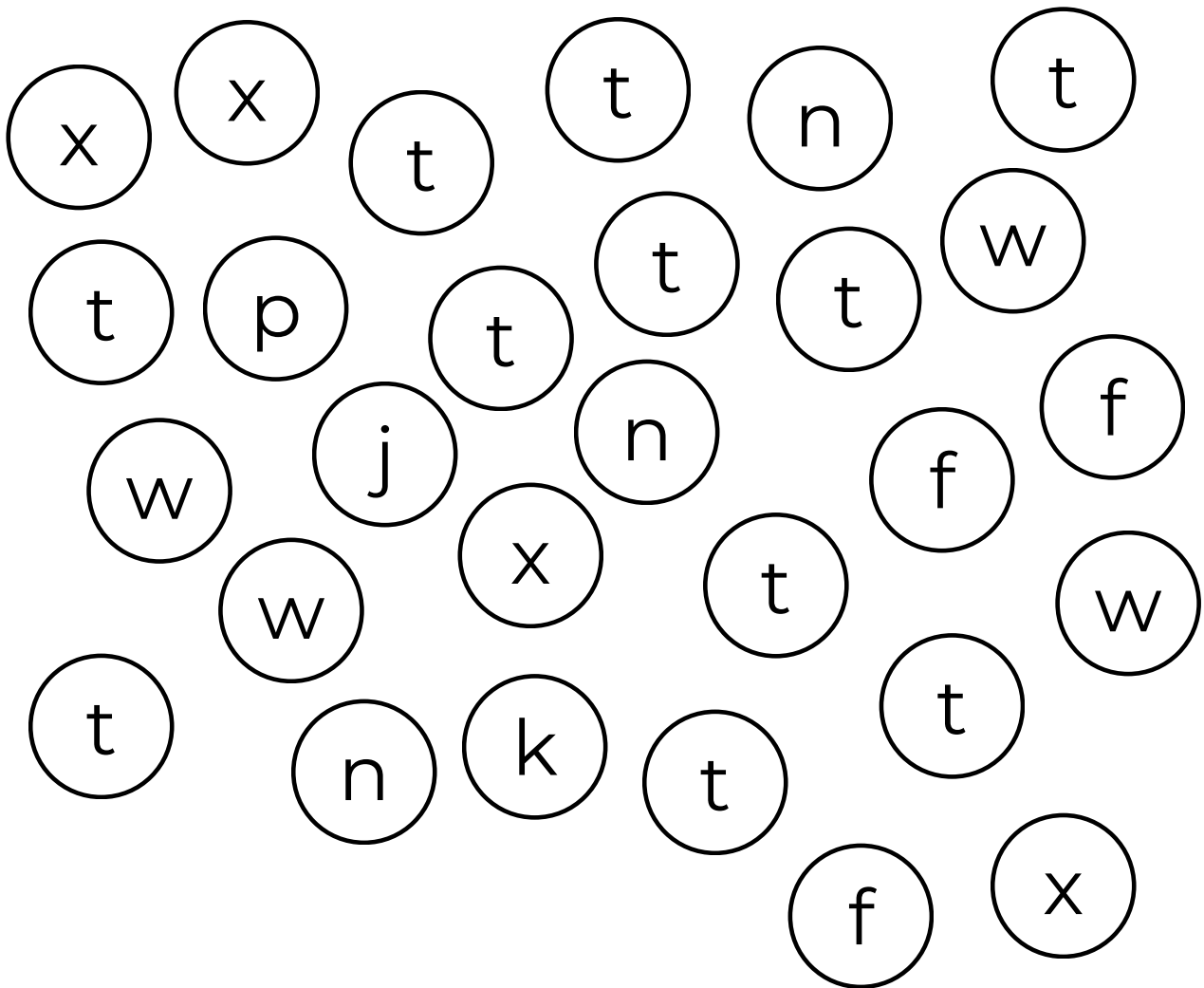

TENTE / tente



Nom \_\_\_\_\_

Date \_\_\_\_\_

Repasse sur la lettre U / u

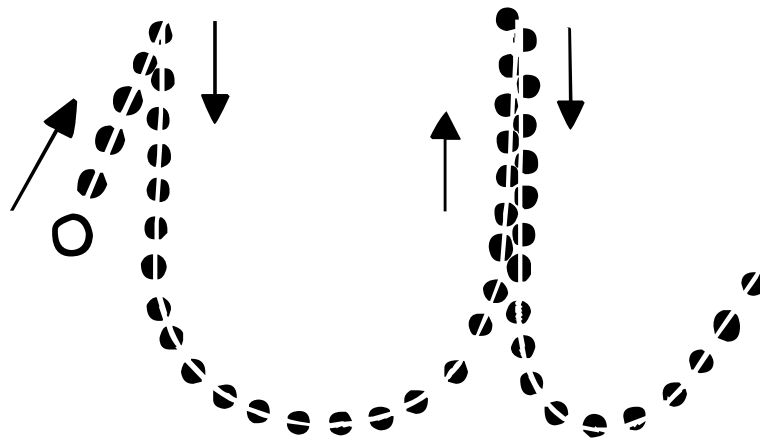

Nom \_\_\_\_\_

Date \_\_\_\_\_

Repasse sur la lettre U / u

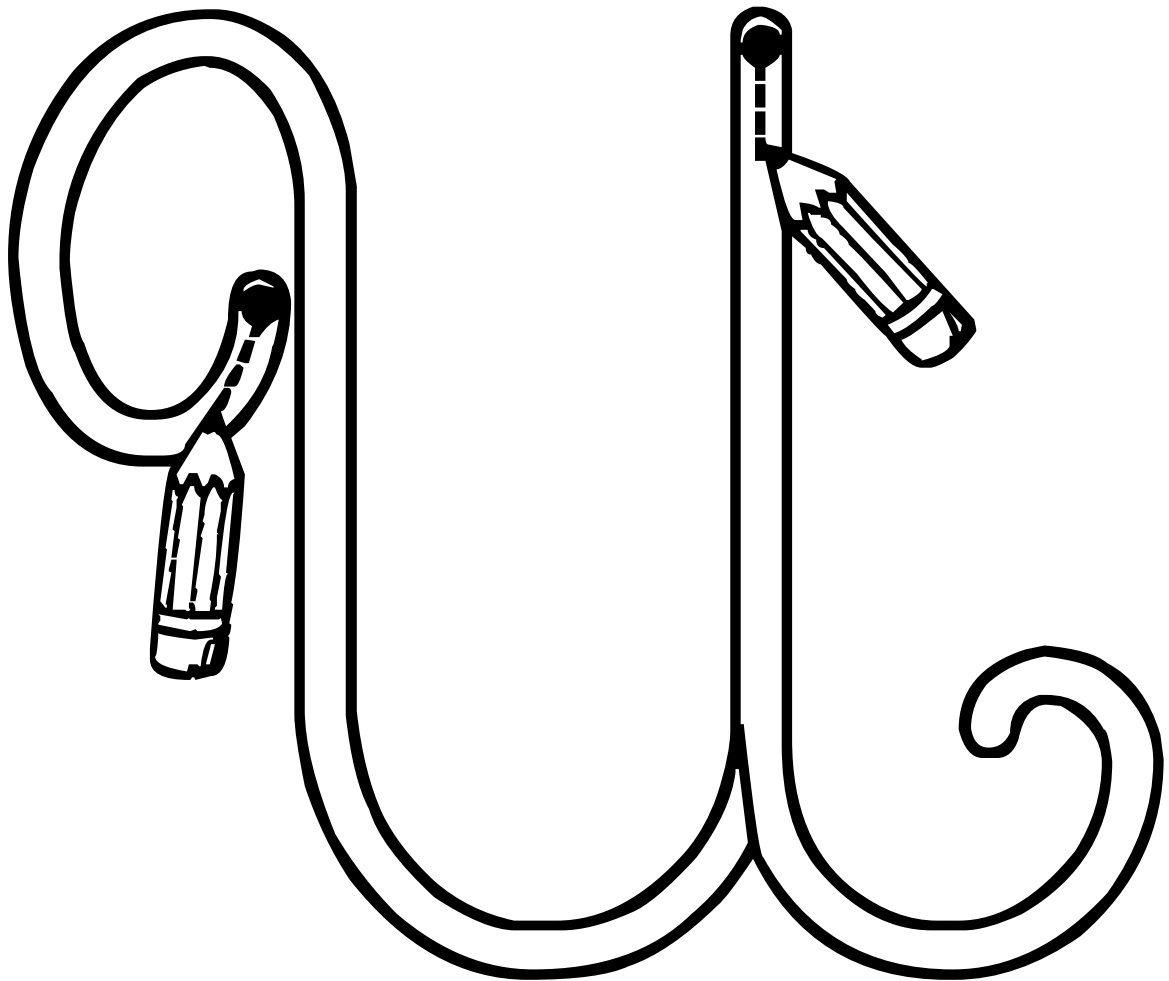

Nom \_\_\_\_\_

Date \_\_\_\_\_

Repasse sur la lettre U / u

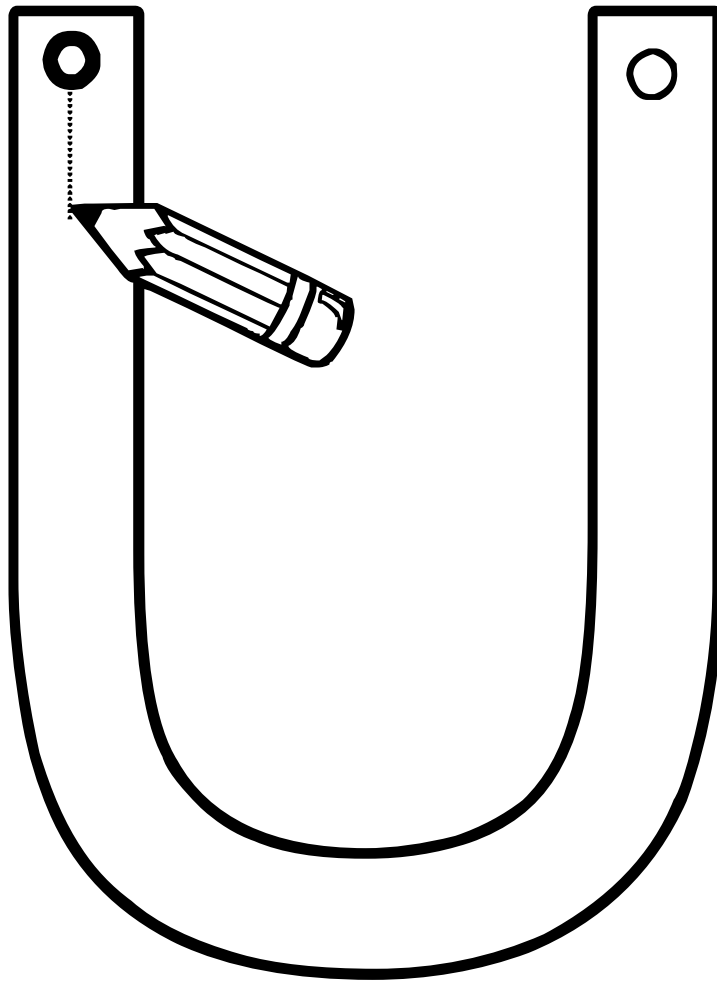

Nom \_\_\_\_\_

Date \_\_\_\_\_

# Ecris la lettre U / u

U U U U U U

U U U U U U

U U U U U U

U U U U U U

U U U U U U

U U U U U U

U U U U U U

Nom \_\_\_\_\_

Date \_\_\_\_\_

# Ecris la lettre U / u

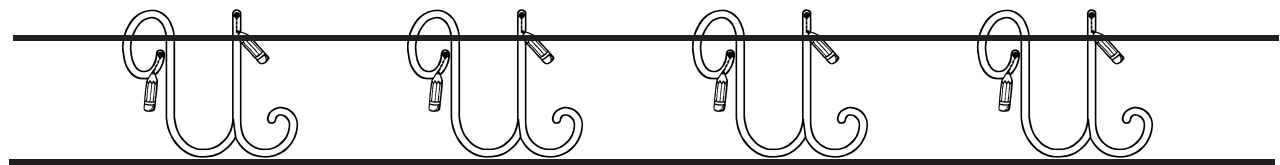
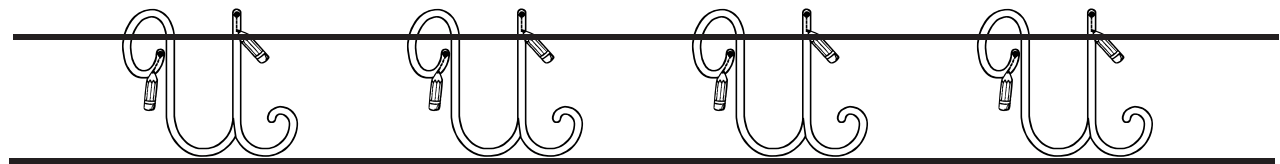
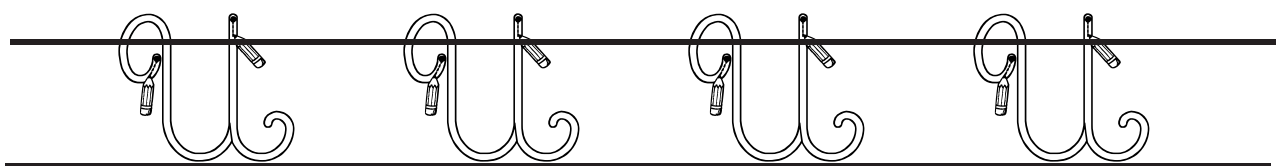
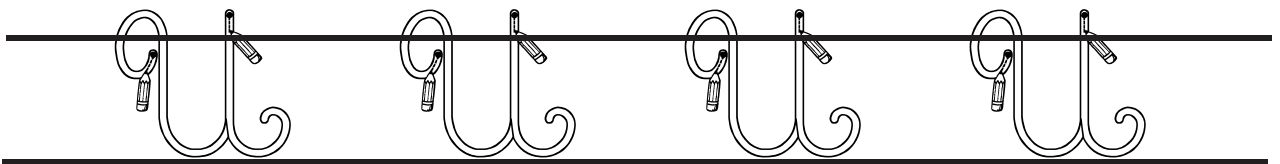
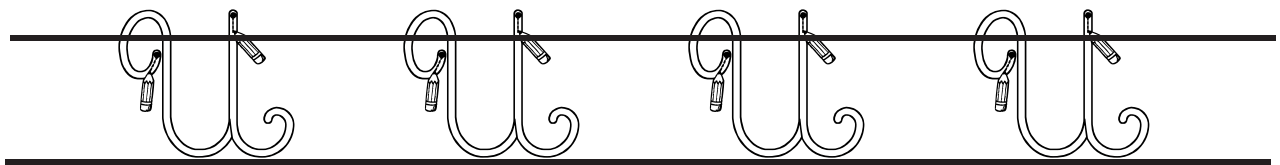
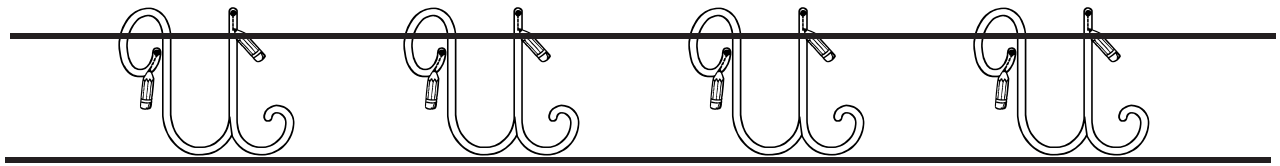
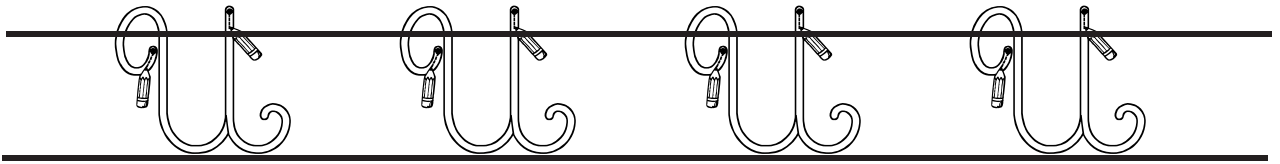

Nom \_\_\_\_\_ Date \_\_\_\_\_

## Ecris la lettre U/u

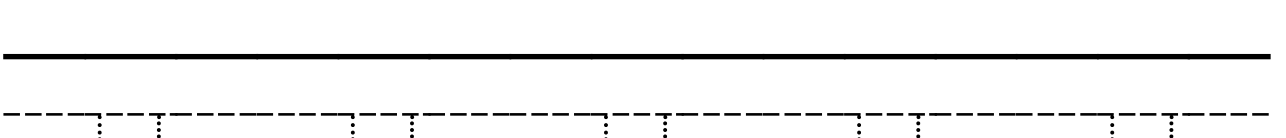
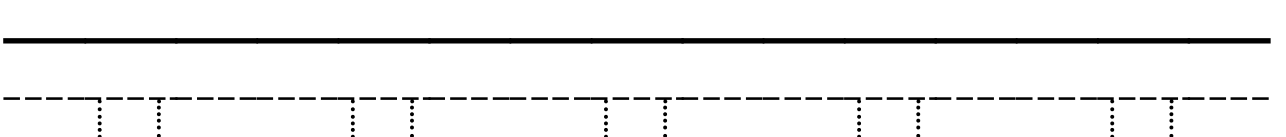
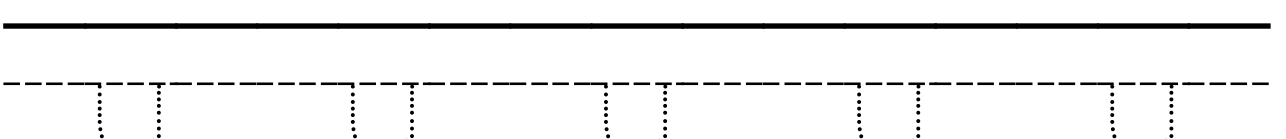
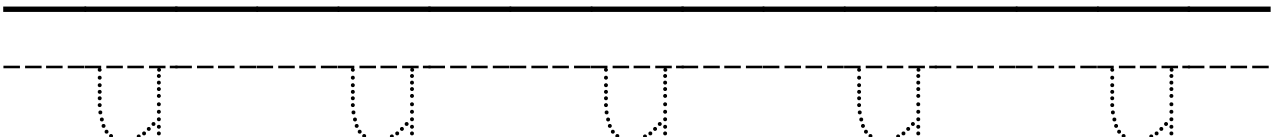
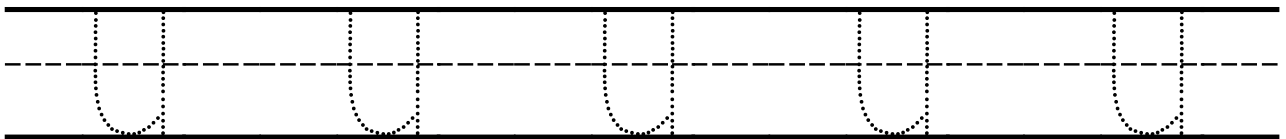
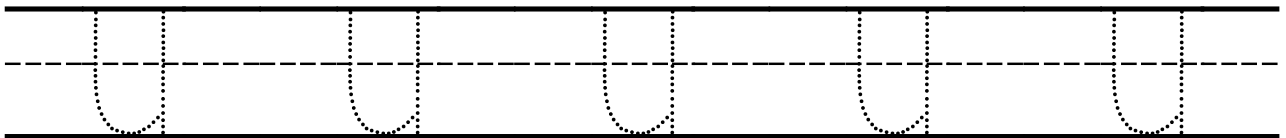
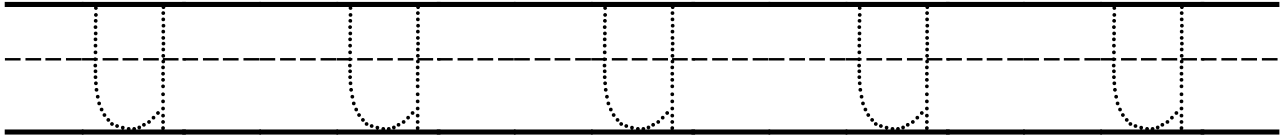
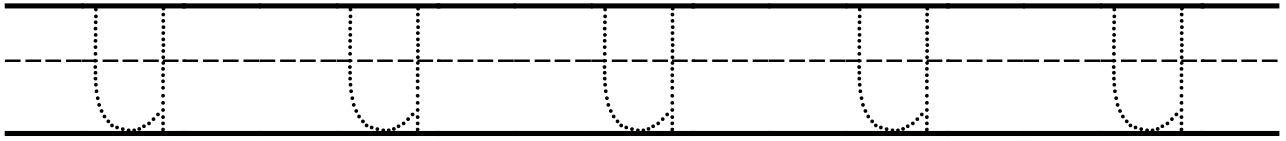

Nom \_\_\_\_\_ Date \_\_\_\_\_

Ecris la lettre U/u

U U U U U

Handwriting practice lines for uppercase 'U'. Each row consists of a solid top line, a dashed middle line, and a solid bottom line. There are two such rows provided for practice.

u u u u u

Handwriting practice lines for lowercase 'u'. Each row consists of a solid top line, a dashed middle line, and a solid bottom line. There are two such rows provided for practice.

Nom \_\_\_\_\_

Date \_\_\_\_\_

## Colorie la lettre U

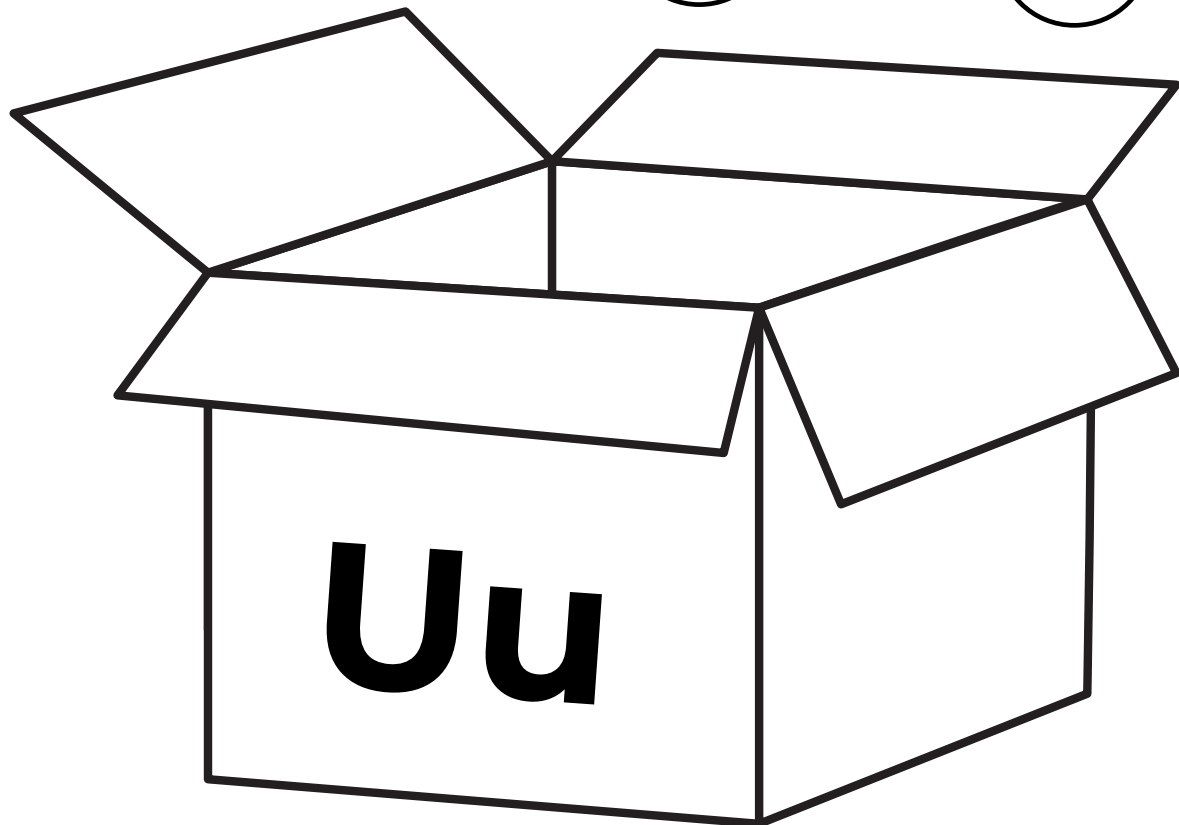
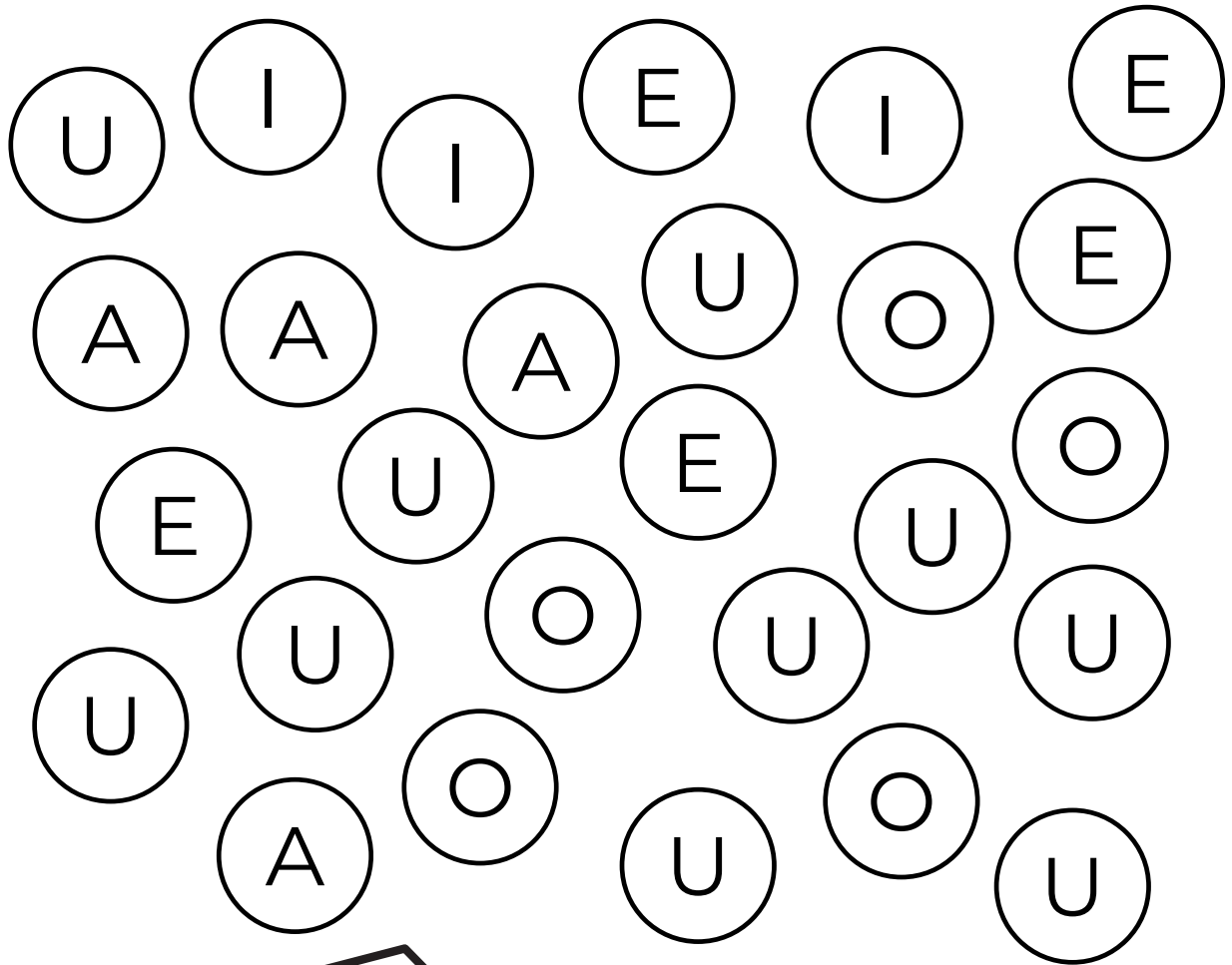

Nom \_\_\_\_\_

Date \_\_\_\_\_

Colorie la lettre u

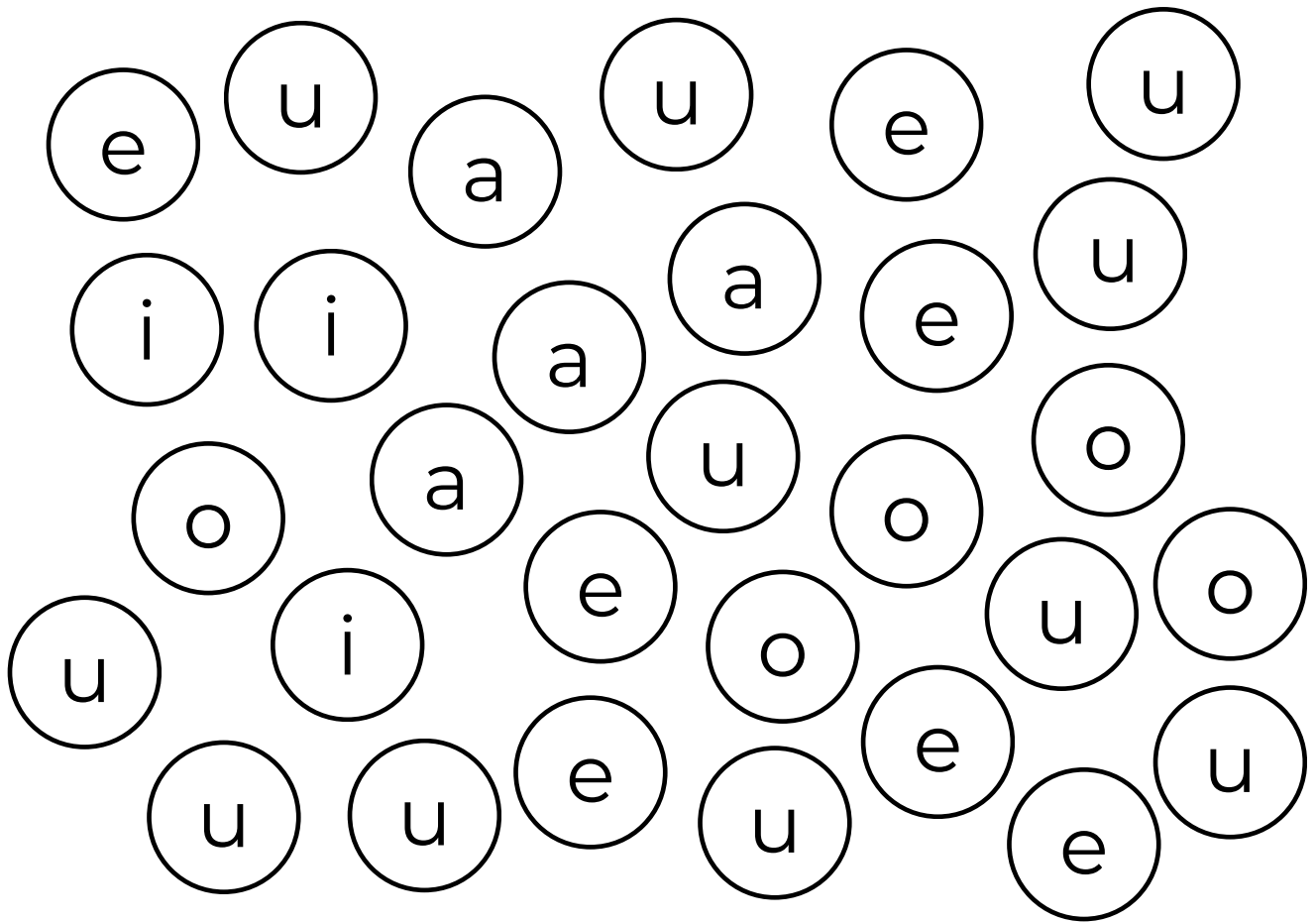

USTENSILES  
ustensiles



Nom \_\_\_\_\_

Date \_\_\_\_\_

Repasse sur la lettre V / v

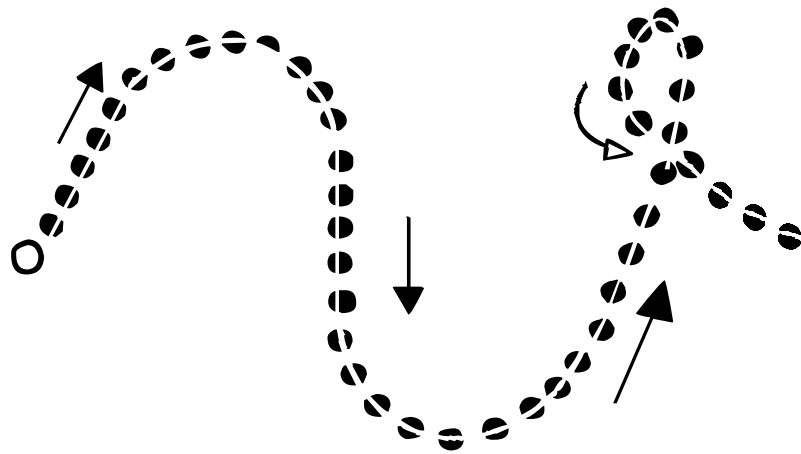

Nom \_\_\_\_\_

Date \_\_\_\_\_

Repasse sur la lettre V / v

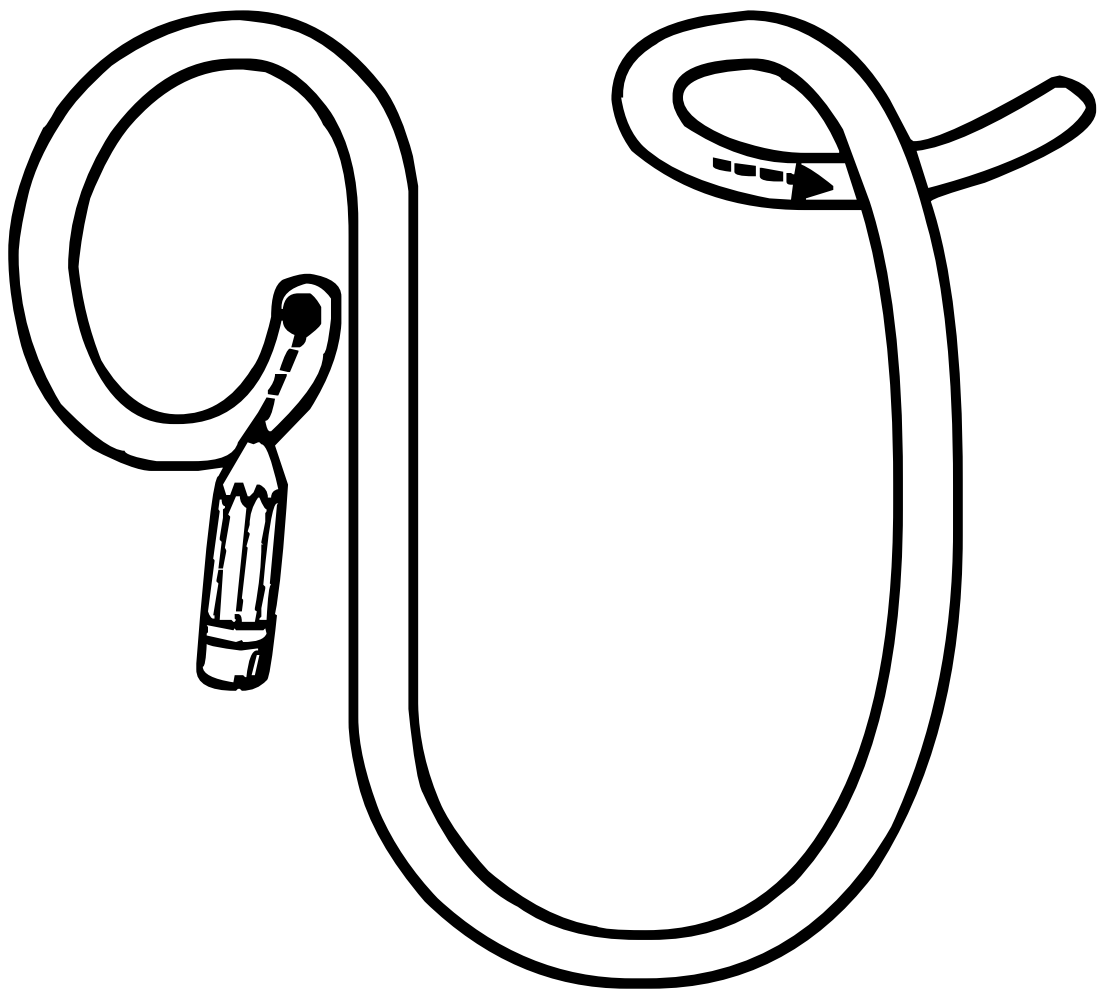

Nom \_\_\_\_\_

Date \_\_\_\_\_

Repasse sur la lettre V / v

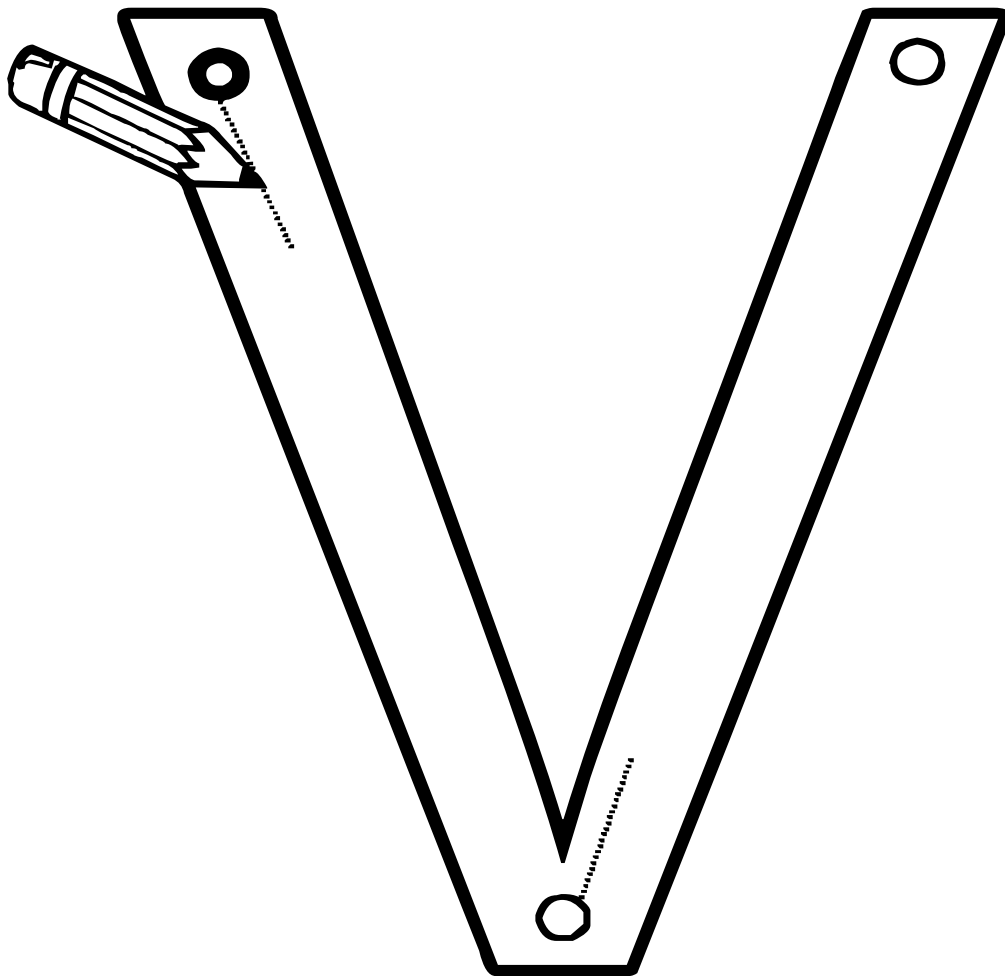

Nom \_\_\_\_\_

Date \_\_\_\_\_

# Ecris la lettre V / v



Nom \_\_\_\_\_

Date \_\_\_\_\_

# Ecris la lettre V / v

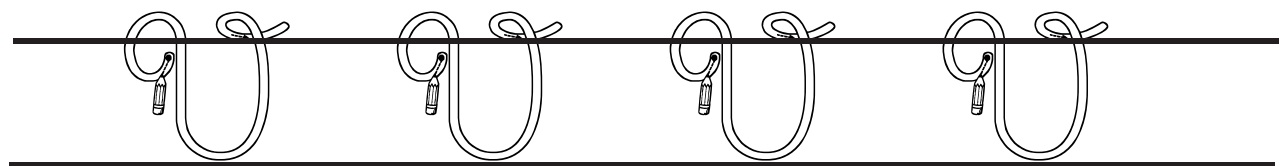
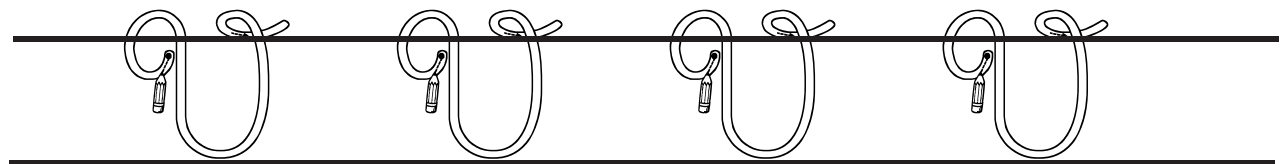
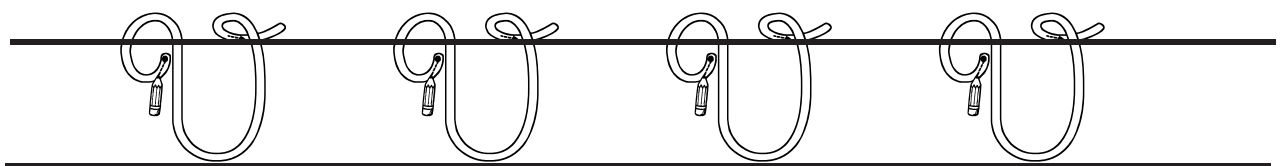
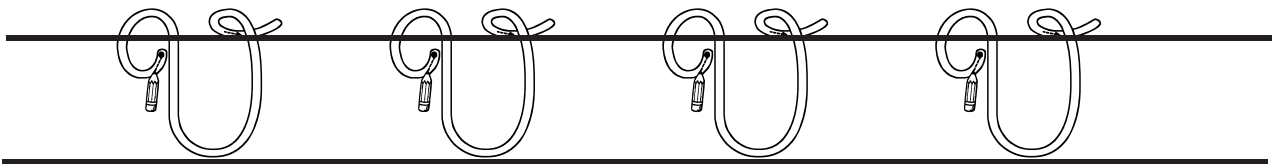
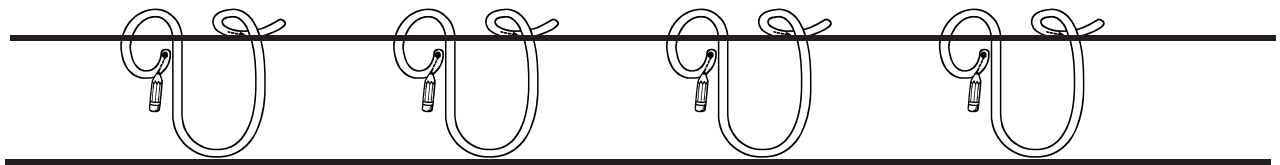
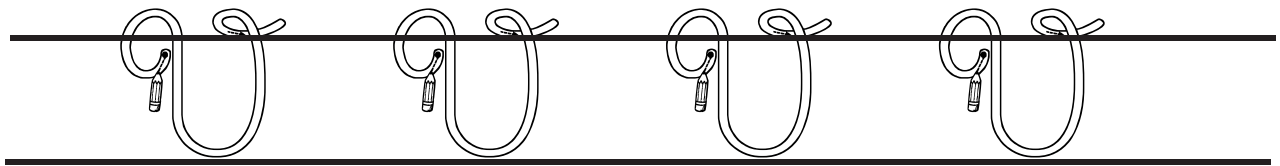
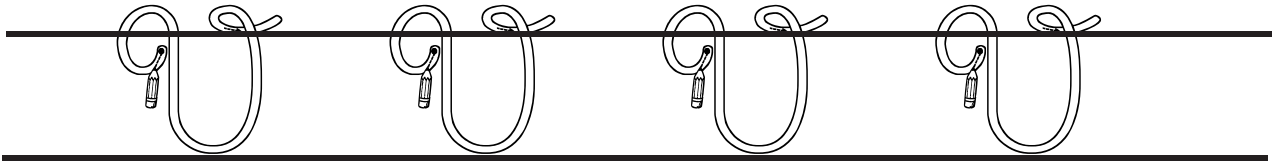

Nom \_\_\_\_\_

Date \_\_\_\_\_

Ecris la lettre V/v

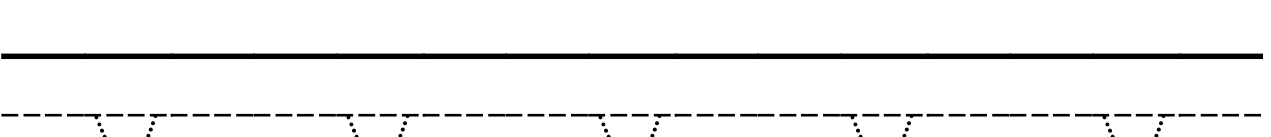
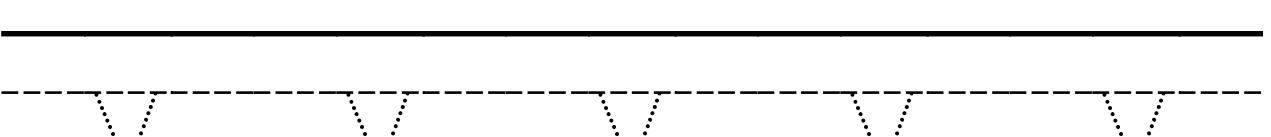
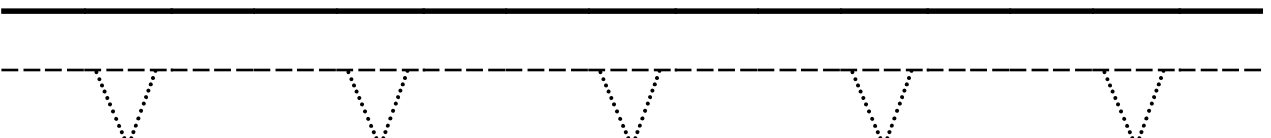
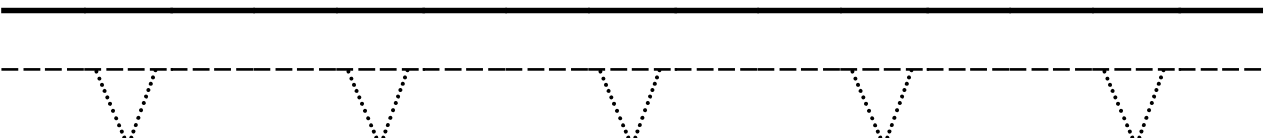
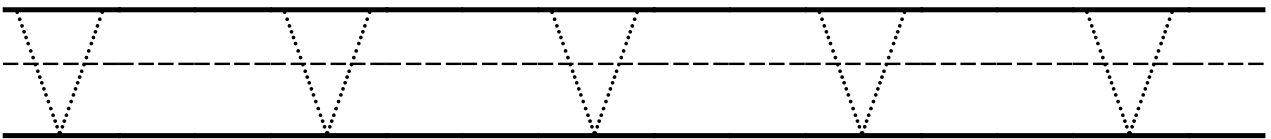
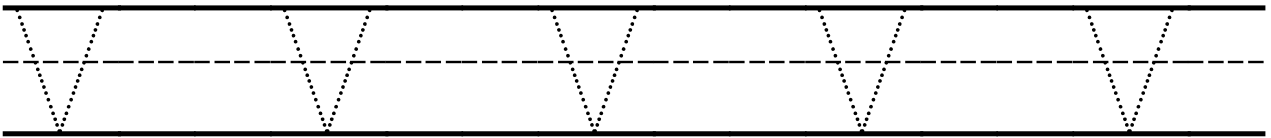
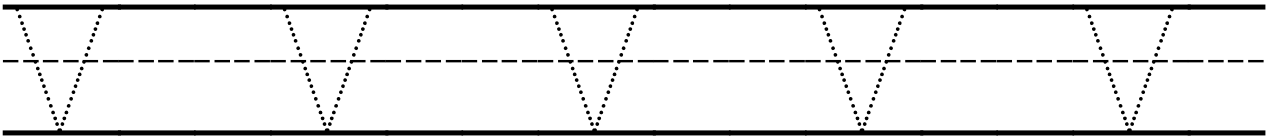
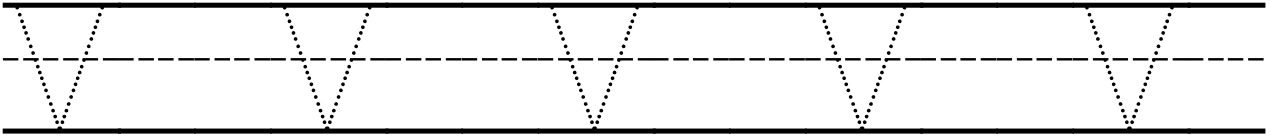

Nom \_\_\_\_\_ Date \_\_\_\_\_

Ecris la lettre V/v

V V V V V

Handwriting practice lines for uppercase 'V'. Each row consists of a solid top line, a dashed middle line, and a solid bottom line. There are two such rows provided for practice.

v v v v v

Handwriting practice lines for lowercase 'v'. Each row consists of a solid top line, a dashed middle line, and a solid bottom line. There are two such rows provided for practice.

Nom \_\_\_\_\_

Date \_\_\_\_\_

## Colorie la lettre V

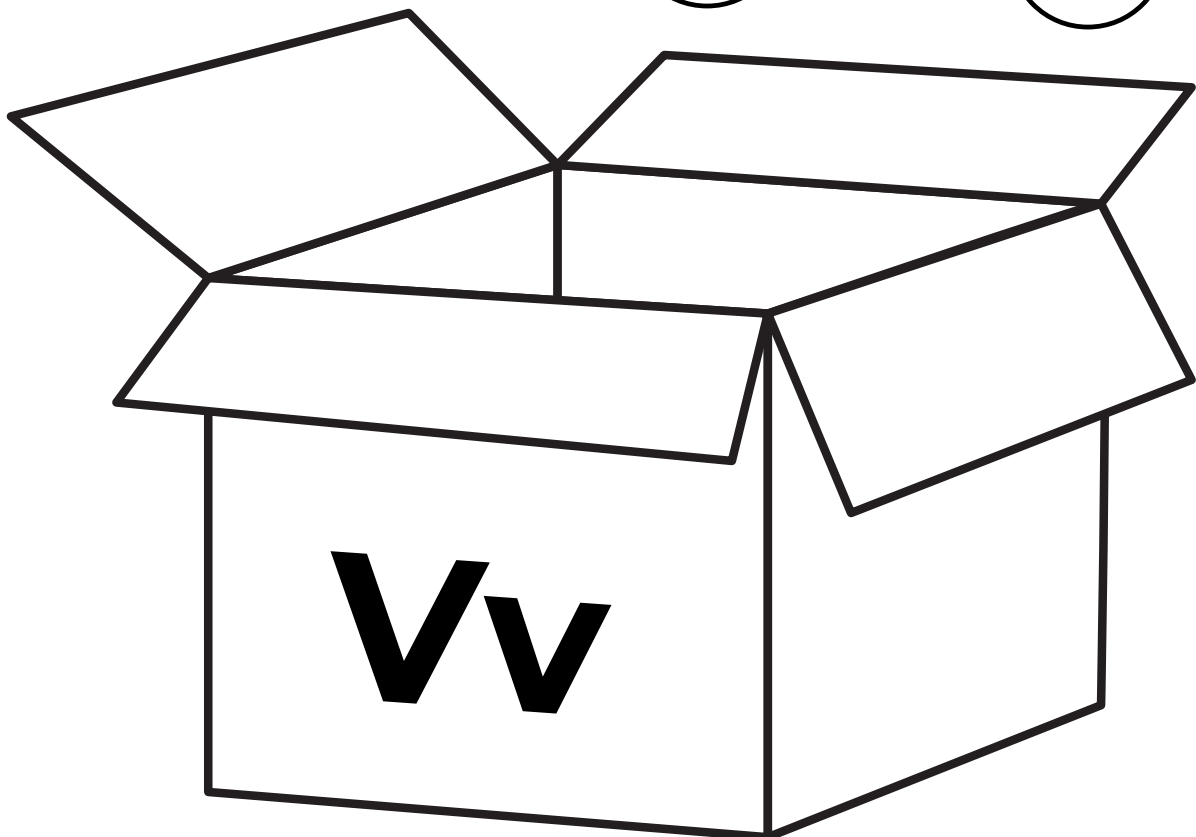
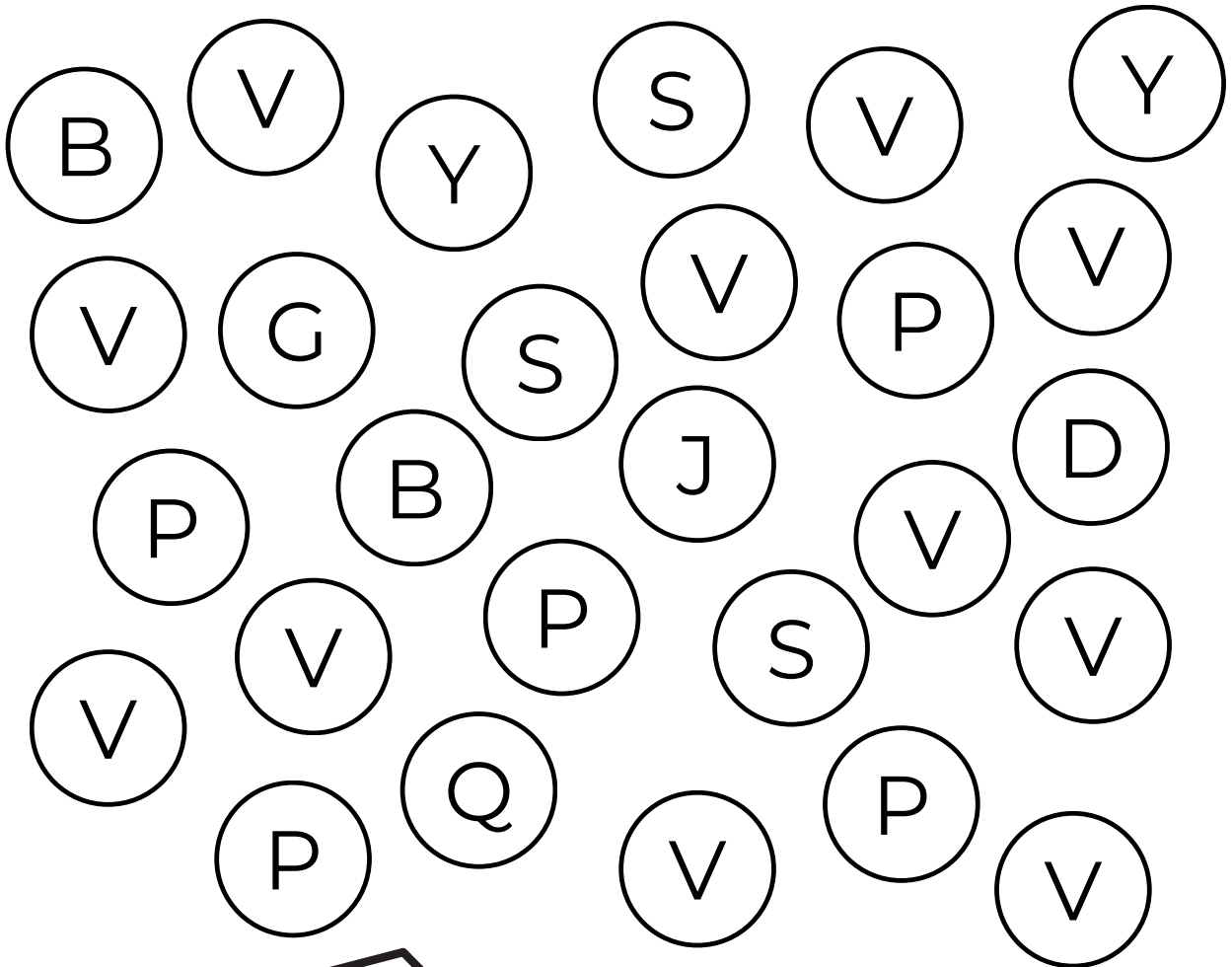

Nom \_\_\_\_\_

Date \_\_\_\_\_

## Colorie la lettre v

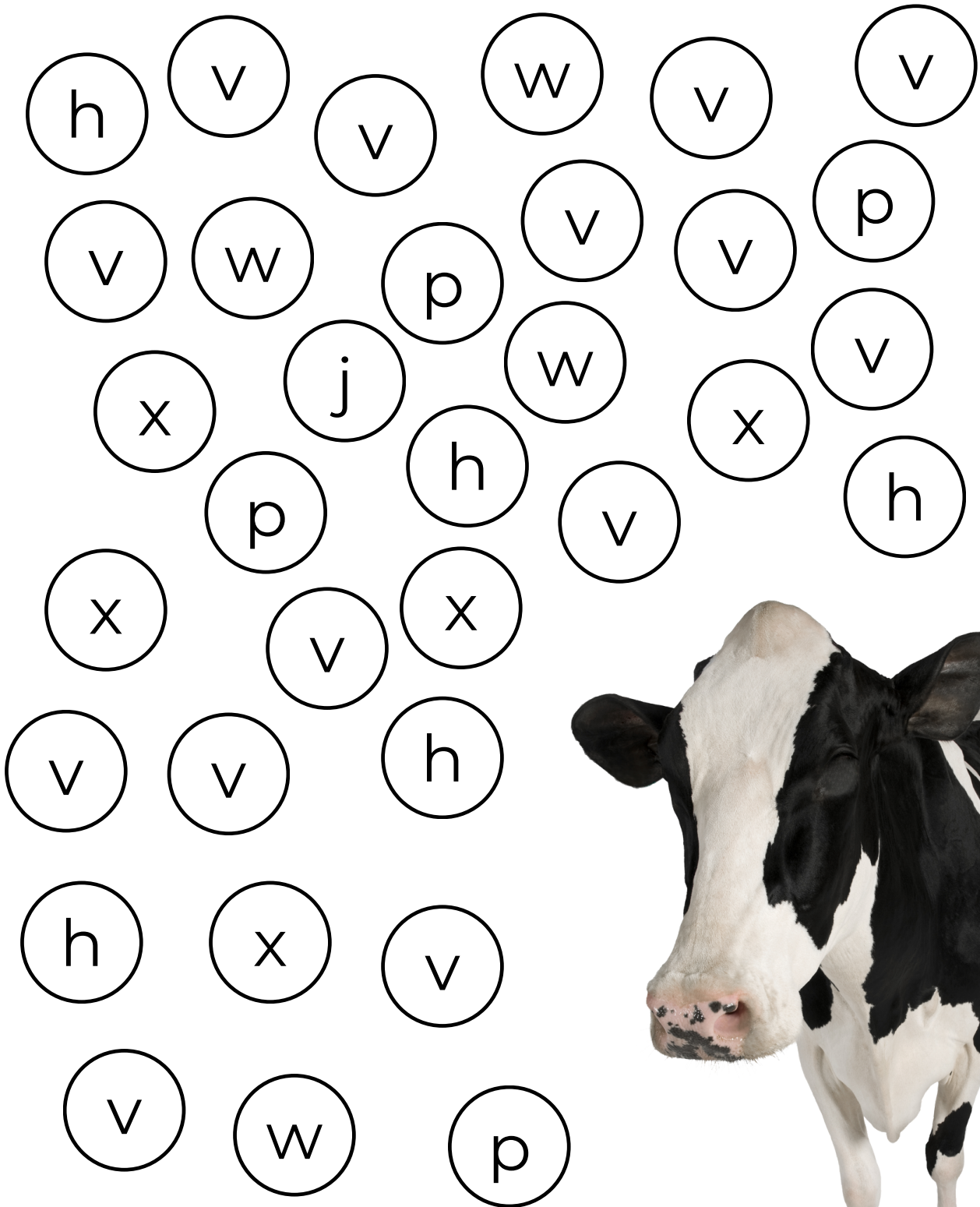

VACHE / vache

Nom \_\_\_\_\_

Date \_\_\_\_\_

Repasse sur la lettre W / w

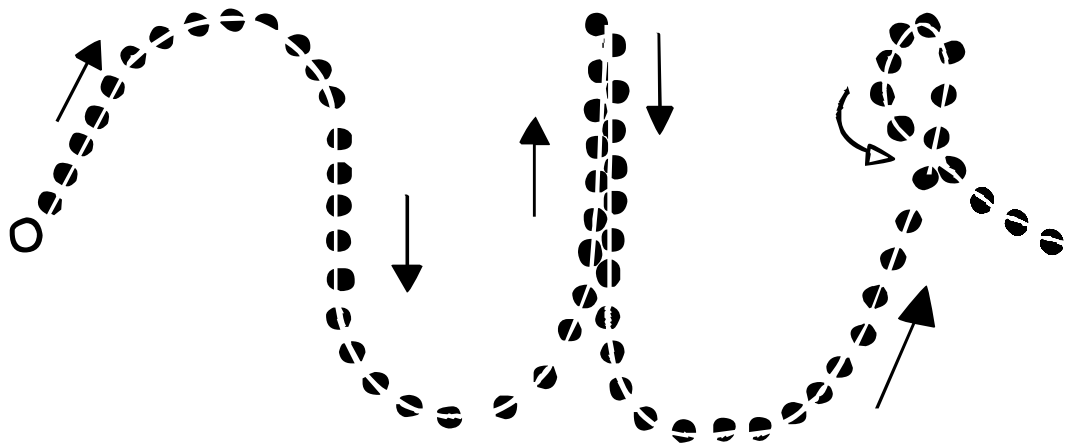

Nom \_\_\_\_\_

Date \_\_\_\_\_

Repasse sur la lettre W / w

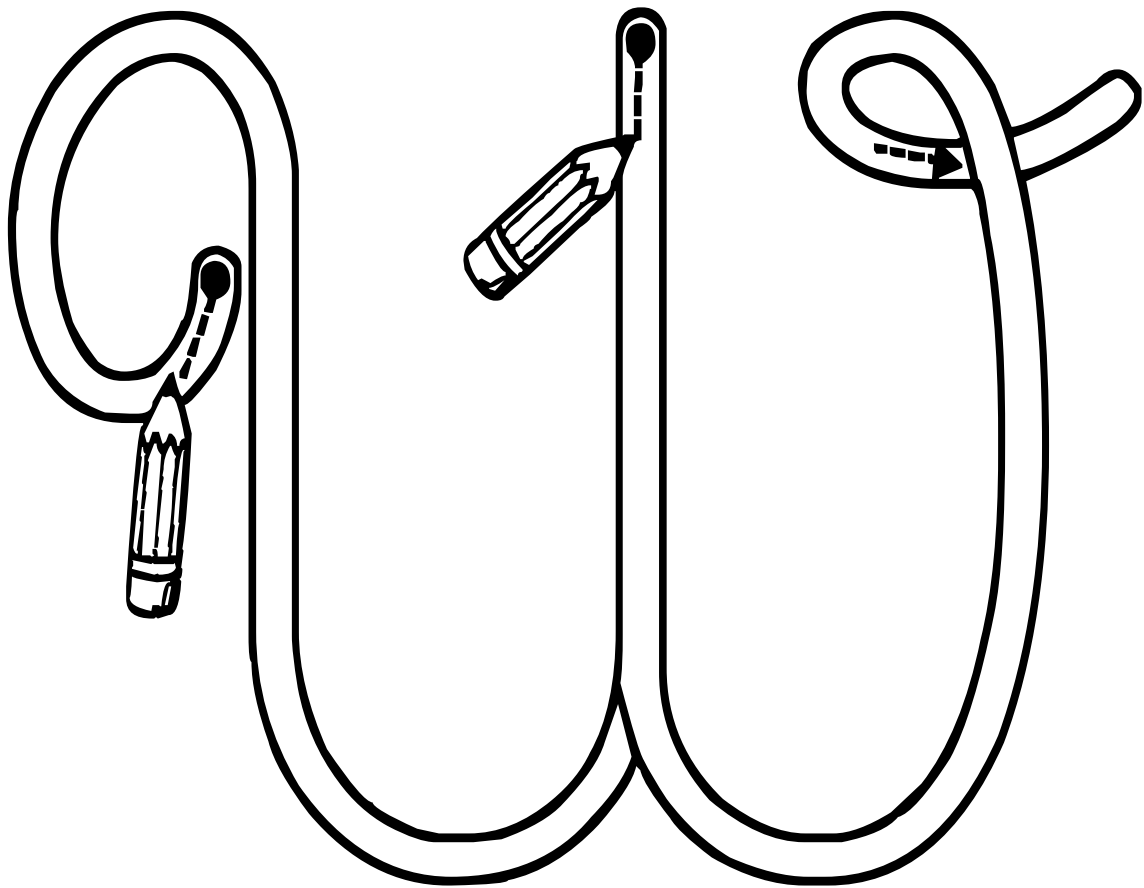

Nom \_\_\_\_\_

Date \_\_\_\_\_

Repasse sur la lettre W / w

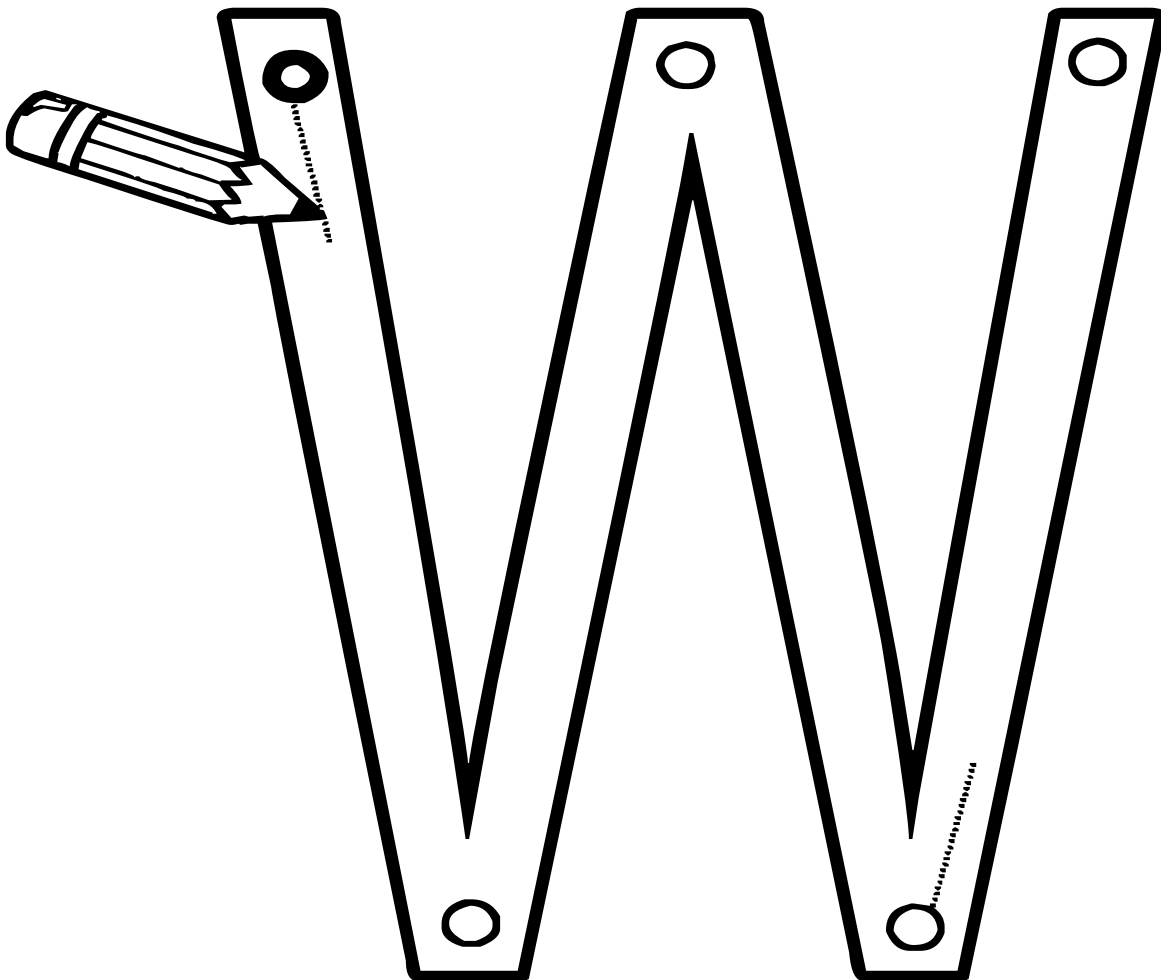

Nom \_\_\_\_\_

Date \_\_\_\_\_

## Ecris la lettre W / w

w

w

w

w

w

w

w

w

w

w

w

w

w

w

w

w

w

w

w

w

w

w

w

w

w

w

w

w

w

w

w

w

w

w

w

Nom \_\_\_\_\_

Date \_\_\_\_\_

# Ecris la lettre W / w

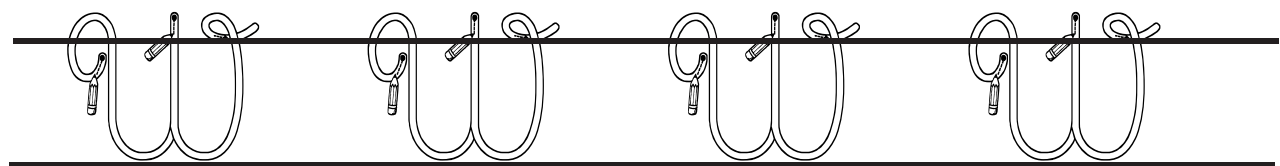
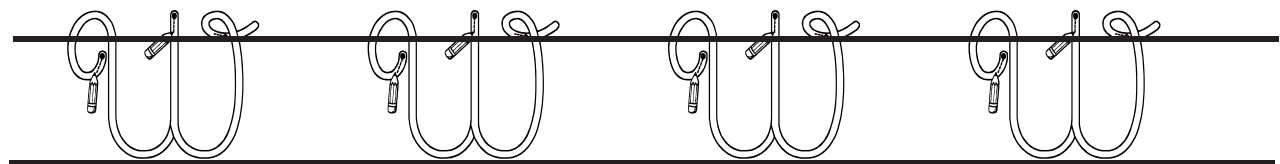
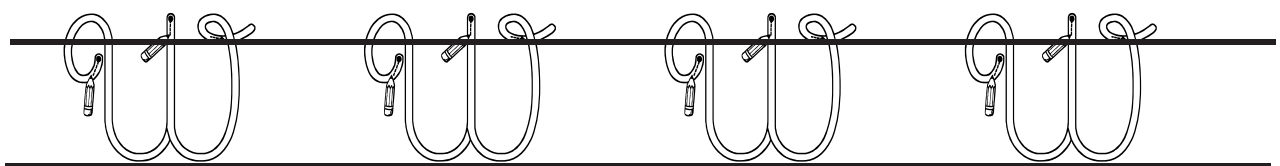
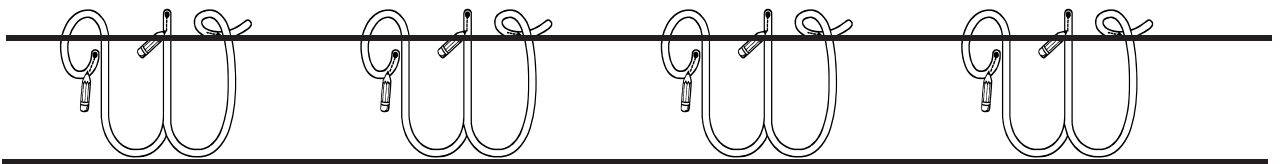
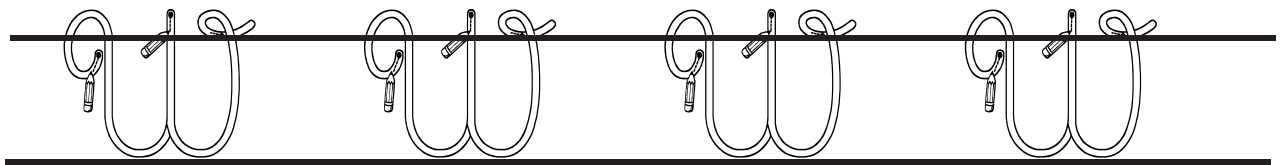
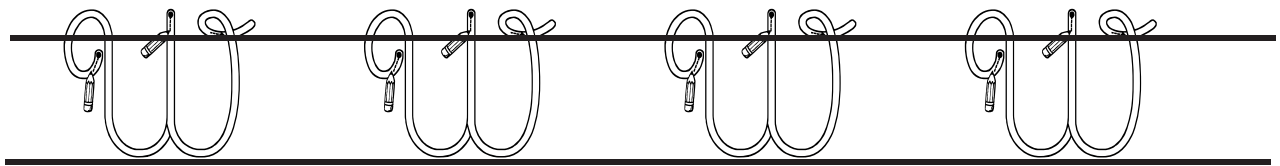
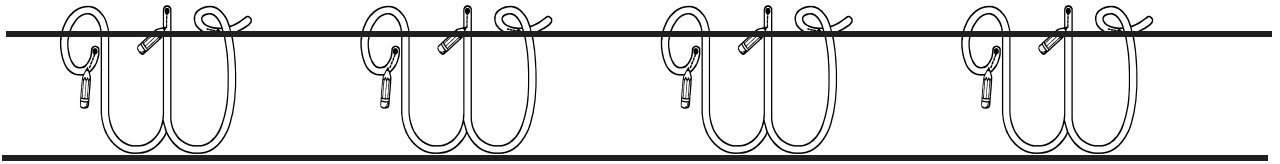

Nom \_\_\_\_\_ Date \_\_\_\_\_

# Ecris la lettre W/w

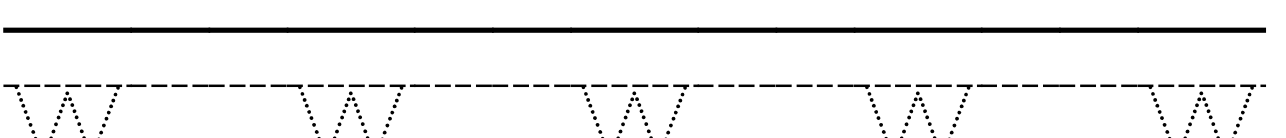
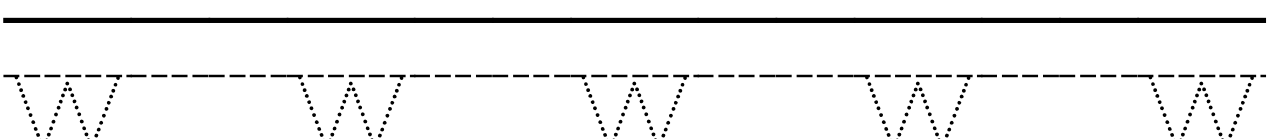
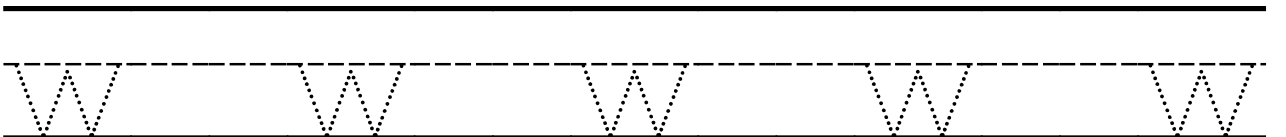
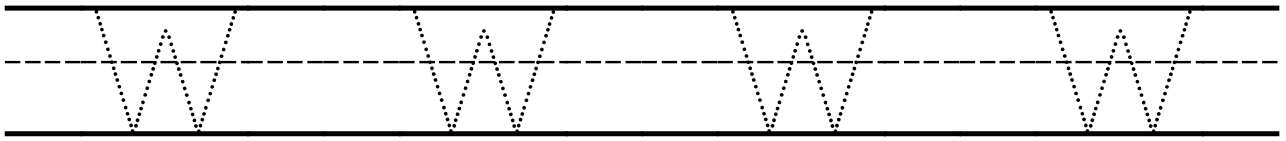

Nom \_\_\_\_\_ Date \_\_\_\_\_

Ecris la lettre W/w

W W W W W

Handwriting practice lines for uppercase 'W'. Each row consists of a solid top line, a dashed middle line, and a solid bottom line.

w w w w w

Handwriting practice lines for lowercase 'w'. Each row consists of a solid top line, a dashed middle line, and a solid bottom line.

Nom \_\_\_\_\_

Date \_\_\_\_\_

## Colorie la lettre W

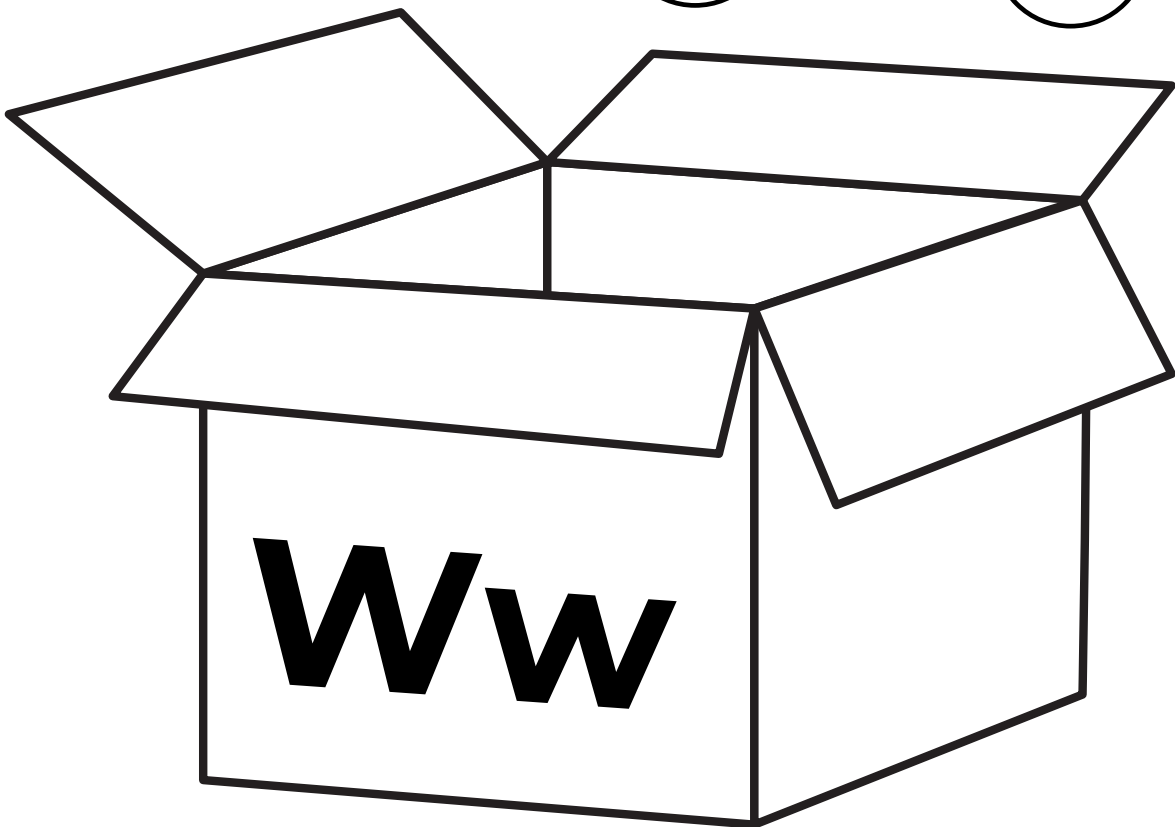
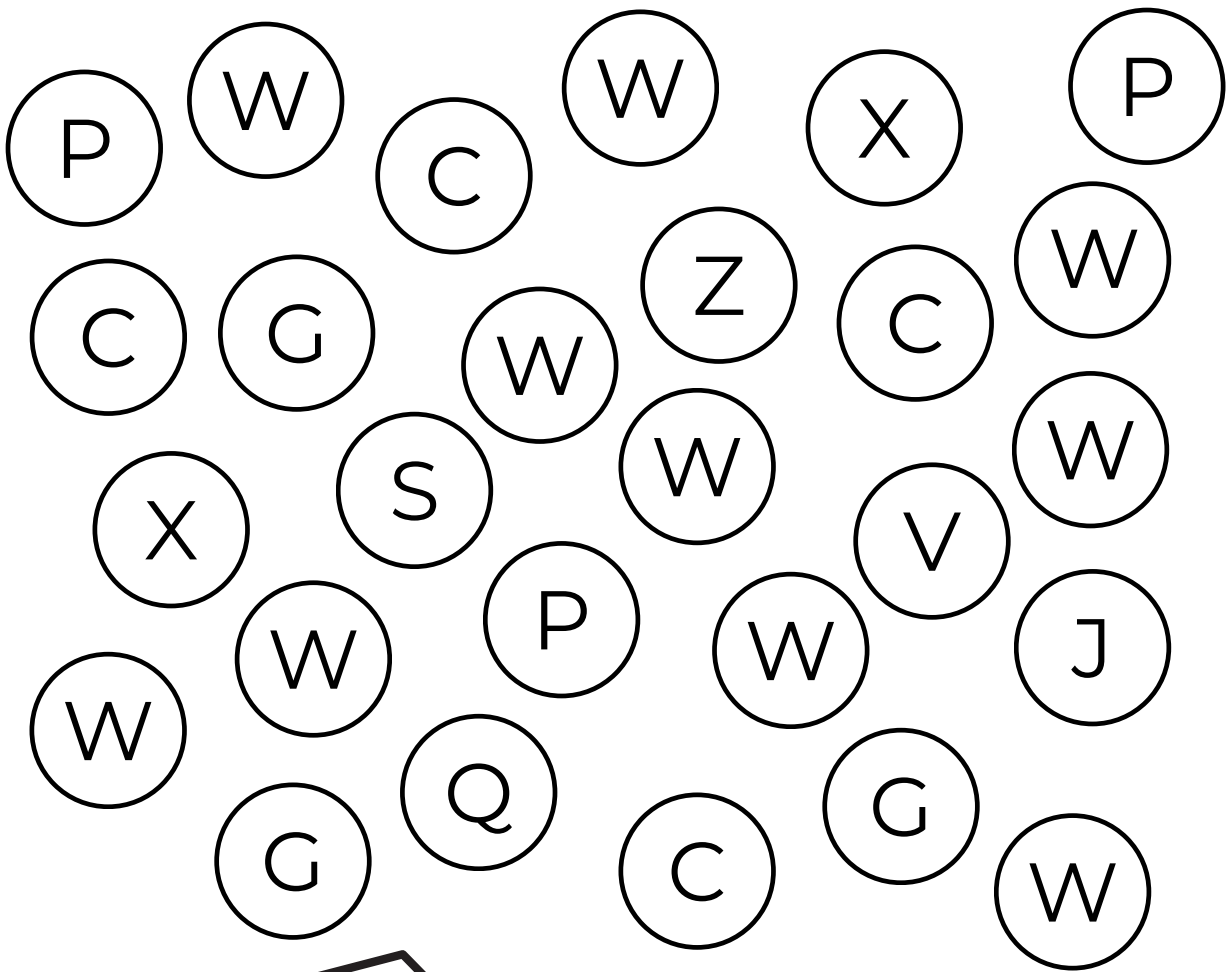

Nom \_\_\_\_\_

Date \_\_\_\_\_

## Colorie la lettre w

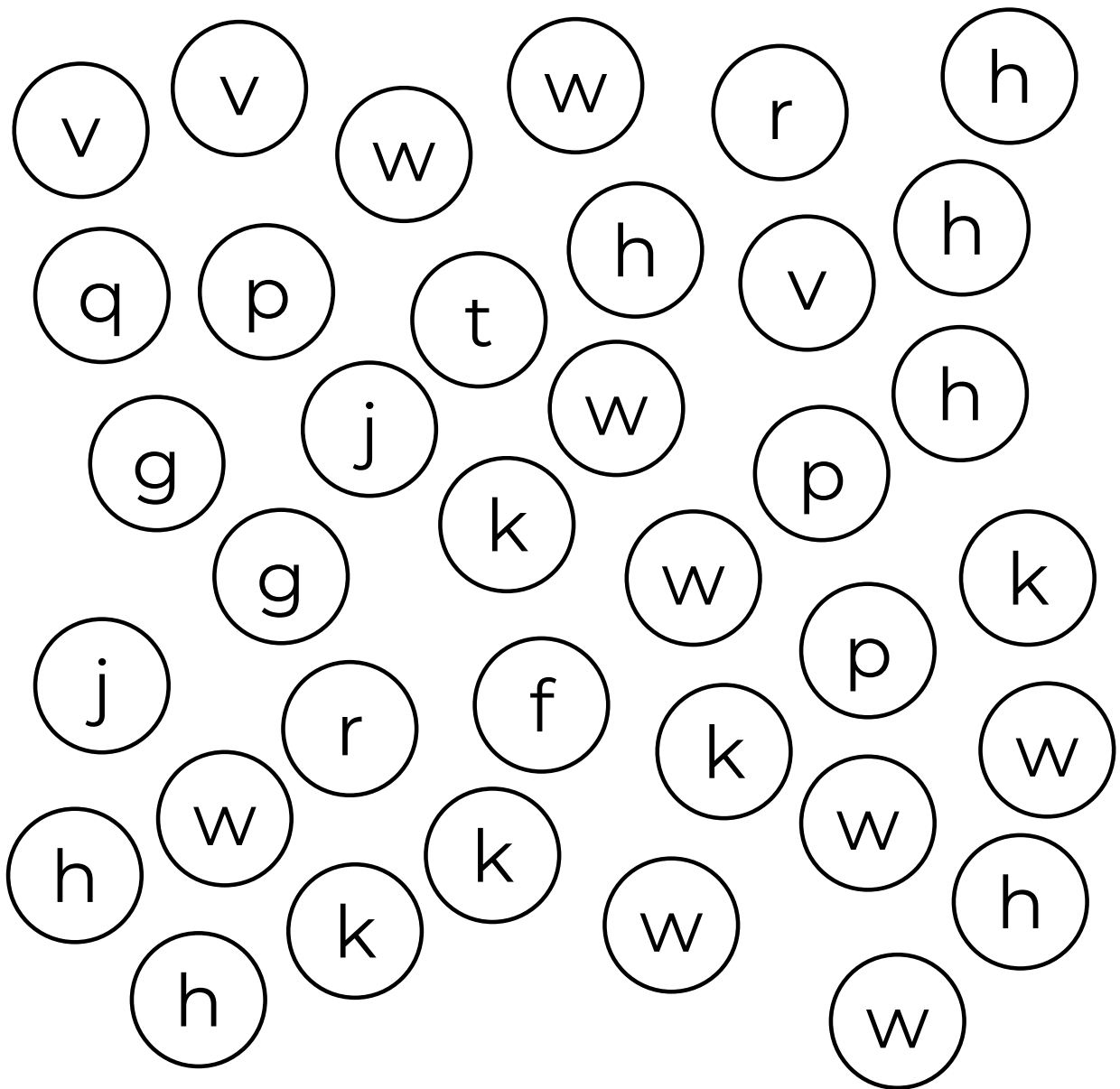

WAGON / wagon

Nom \_\_\_\_\_

Date \_\_\_\_\_

Repasse sur la lettre X / x

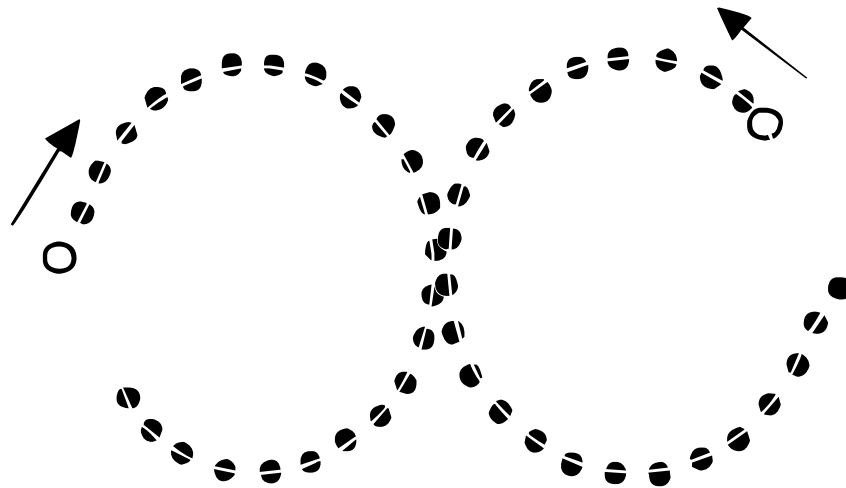

Nom \_\_\_\_\_

Date \_\_\_\_\_

Repasse sur la lettre X / x

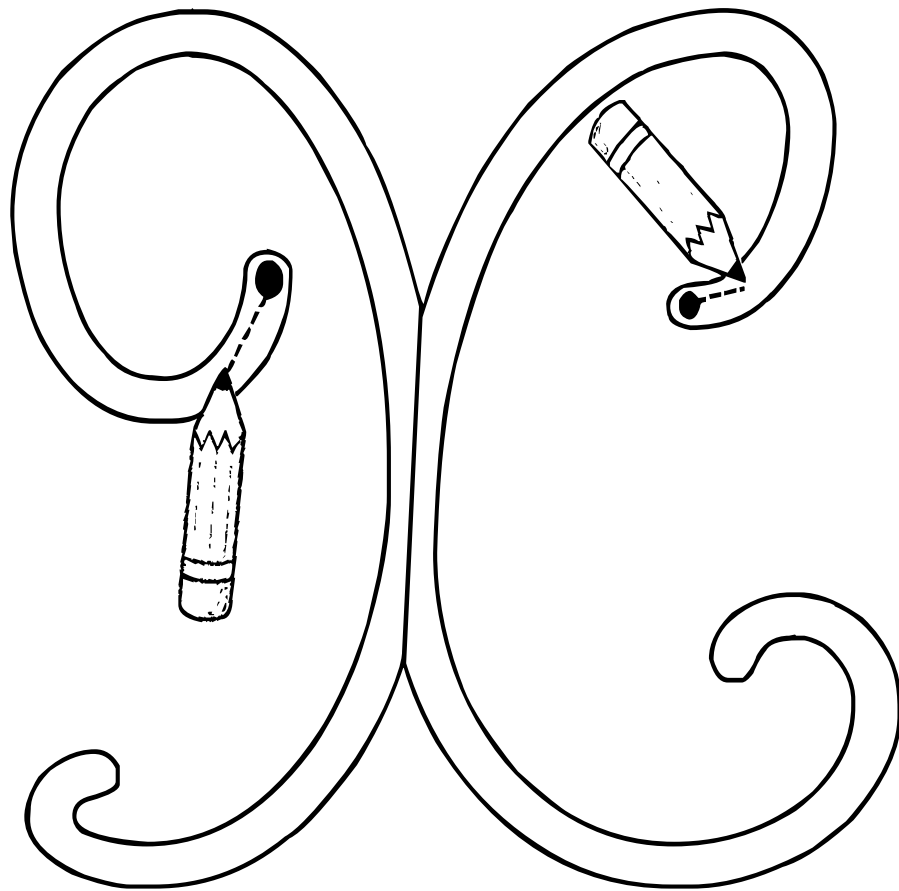

Nom \_\_\_\_\_

Date \_\_\_\_\_

Repasse sur la lettre X / x

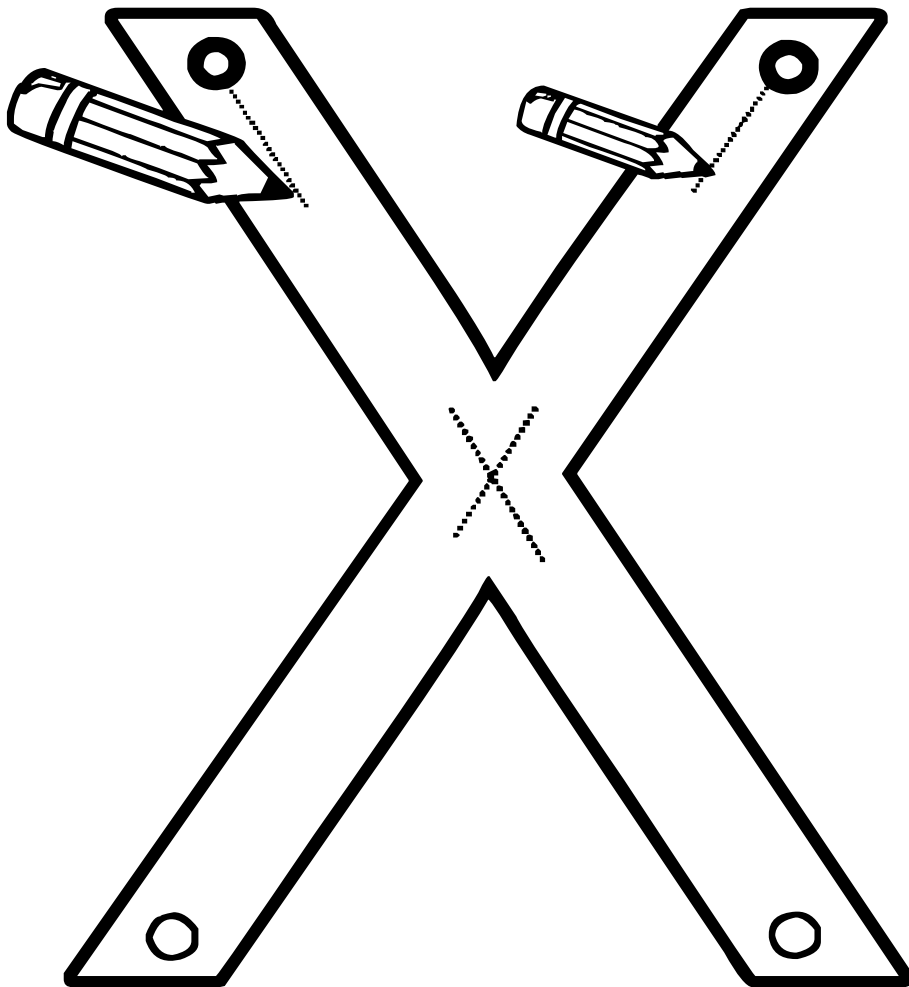

Nom \_\_\_\_\_

Date \_\_\_\_\_

# Ecris la lettre X / x



Nom \_\_\_\_\_

Date \_\_\_\_\_

# Ecris la lettre X / x

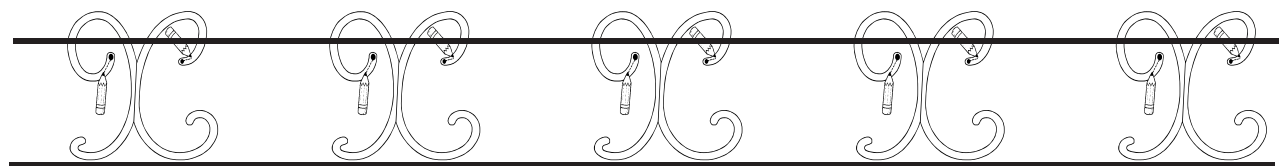
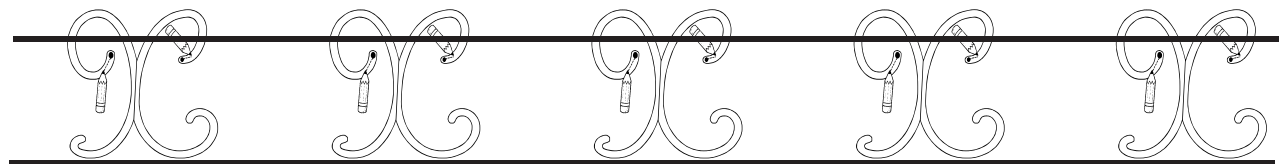
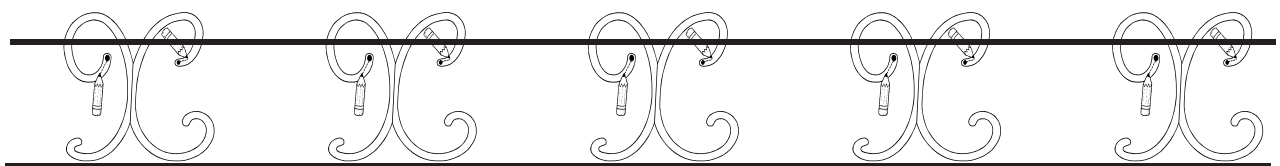
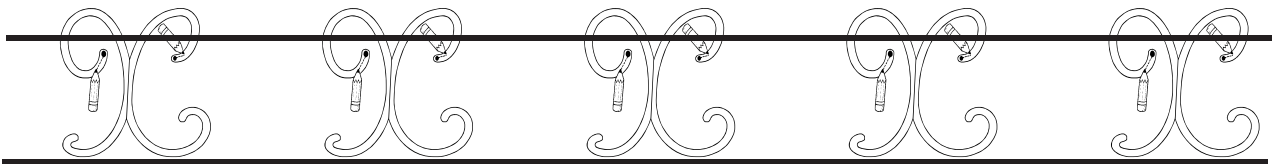
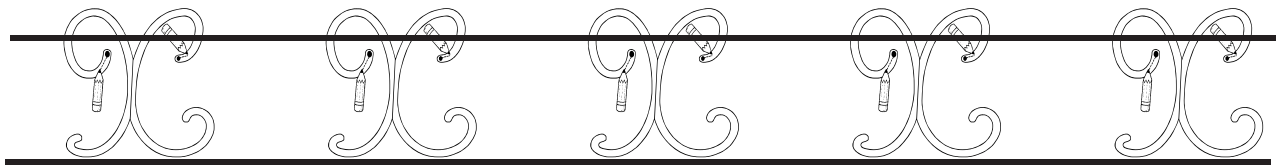
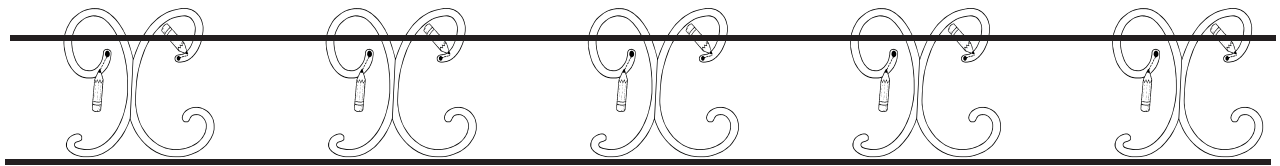
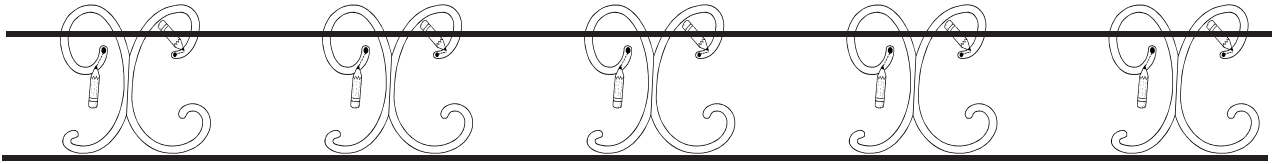

Nom \_\_\_\_\_ Date \_\_\_\_\_

# Ecris la lettre X/x

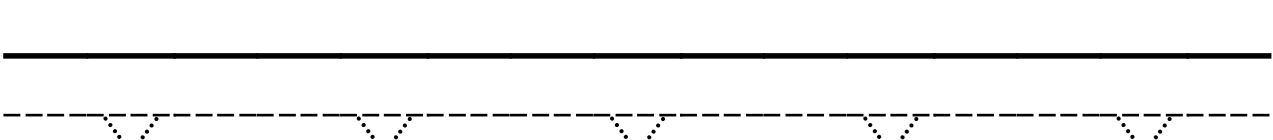
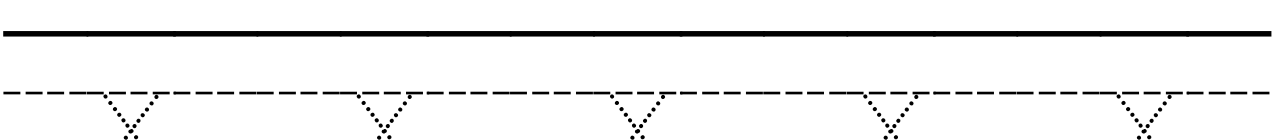
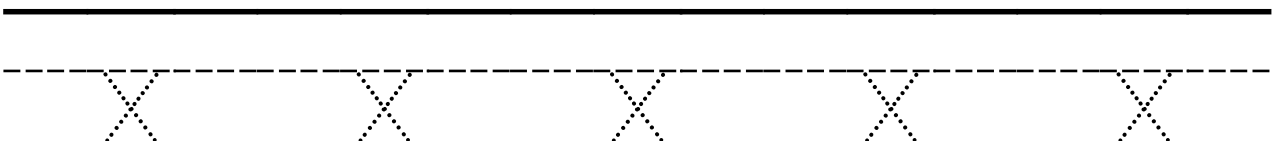
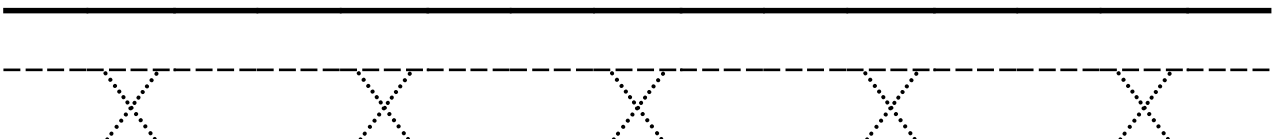
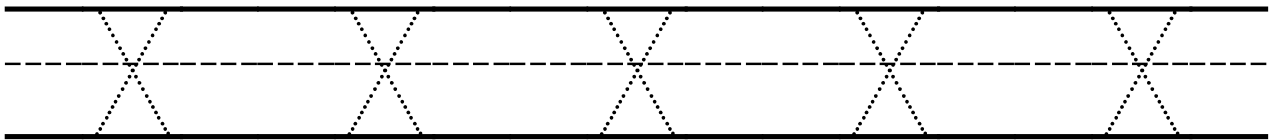
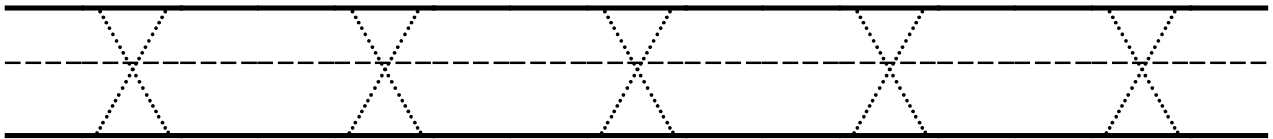
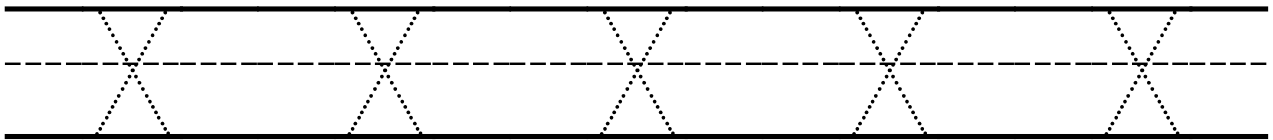
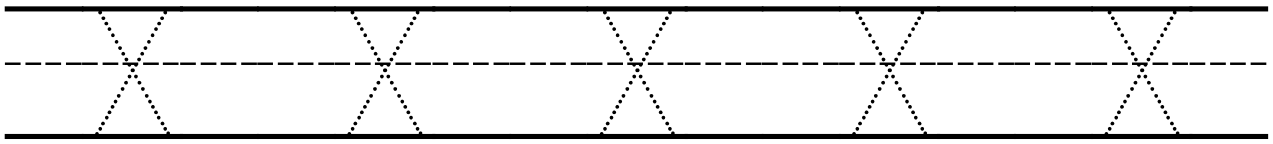

Nom \_\_\_\_\_ Date \_\_\_\_\_

Ecris la lettre X/x

X

X

X

X

X

Handwriting practice lines for uppercase X. The first set consists of a solid top line, a dashed middle line, and a solid bottom line. The second set consists of a solid top line, a dashed middle line, and a solid bottom line.

x

x

x

x

x

Handwriting practice lines for lowercase x. The first set consists of a solid top line, a dashed middle line, and a solid bottom line. The second set consists of a solid top line, a dashed middle line, and a solid bottom line.

Nom \_\_\_\_\_ Date \_\_\_\_\_

# Colorie la lettre X

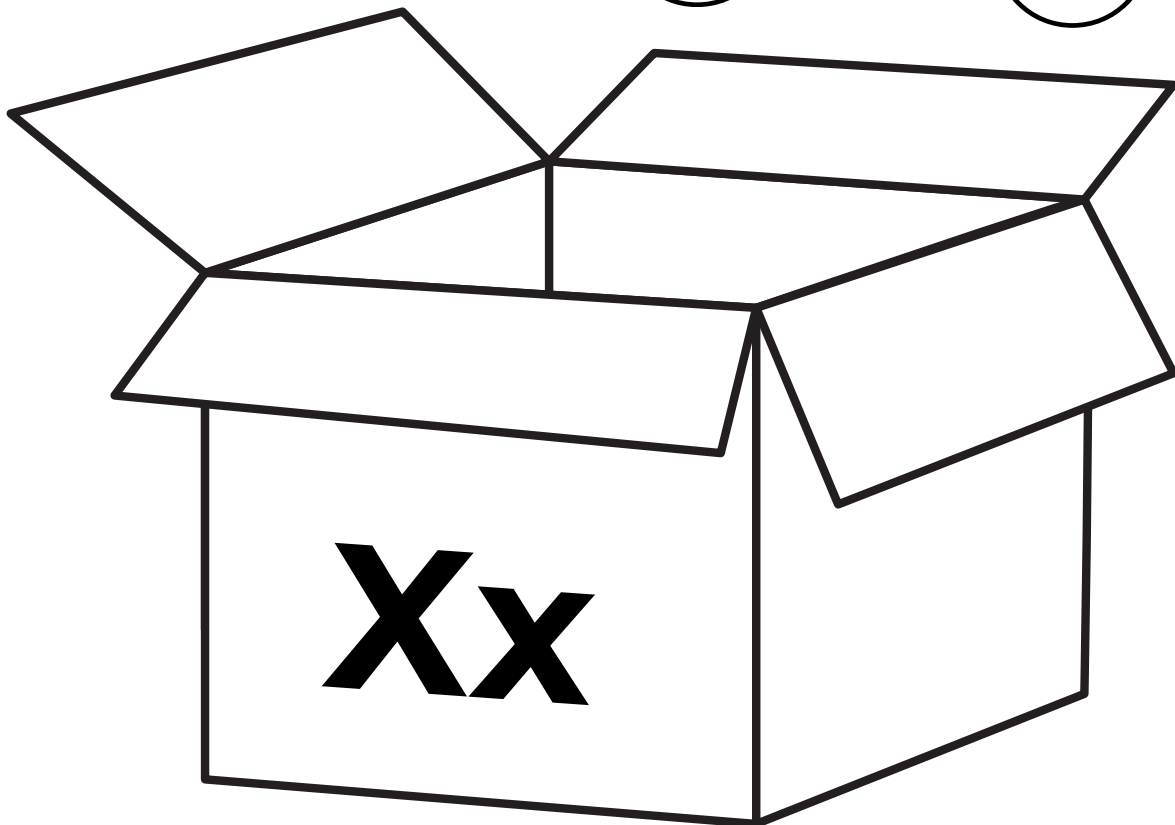
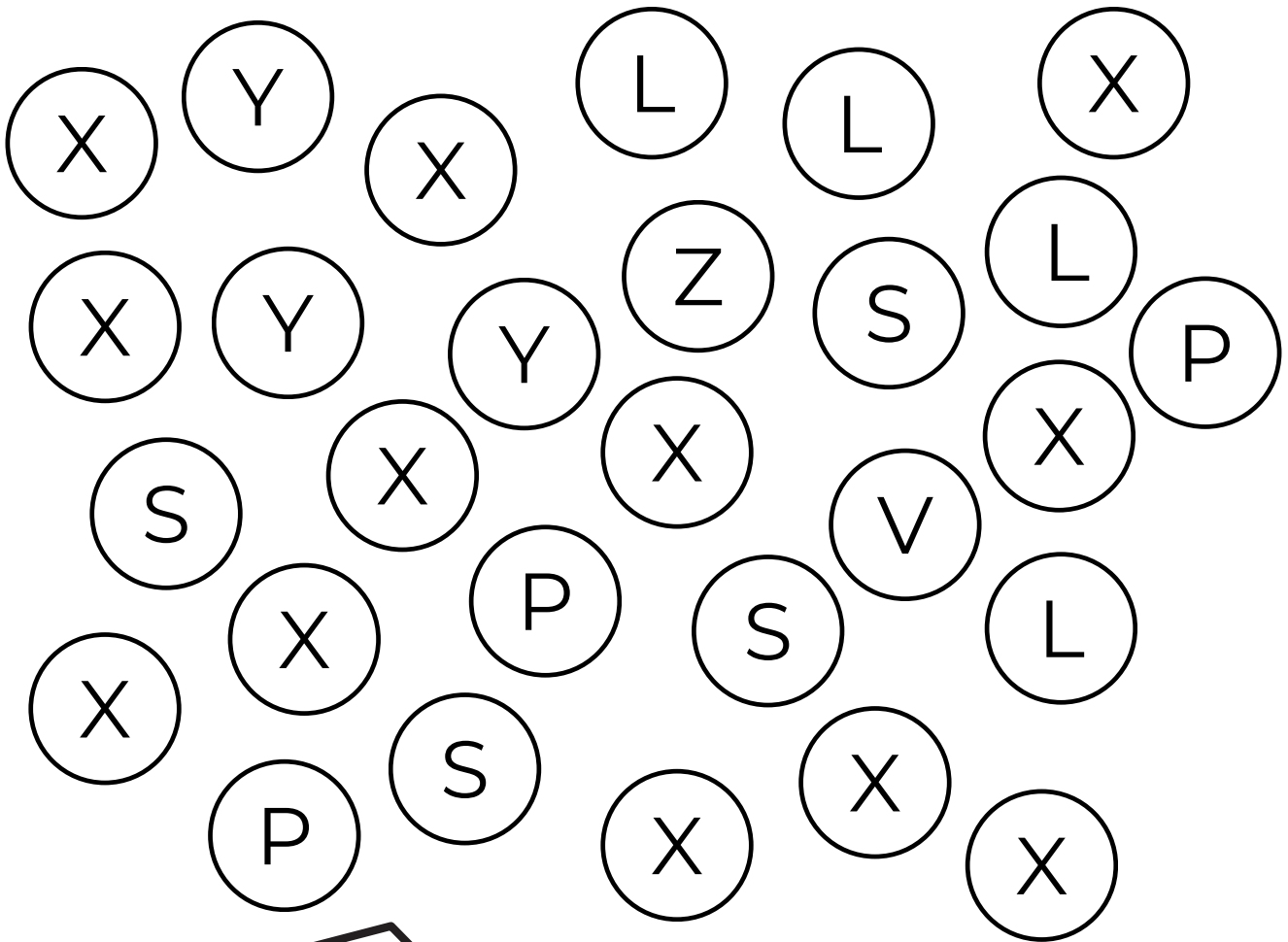

Nom \_\_\_\_\_

Date \_\_\_\_\_

## Colorie la lettre x

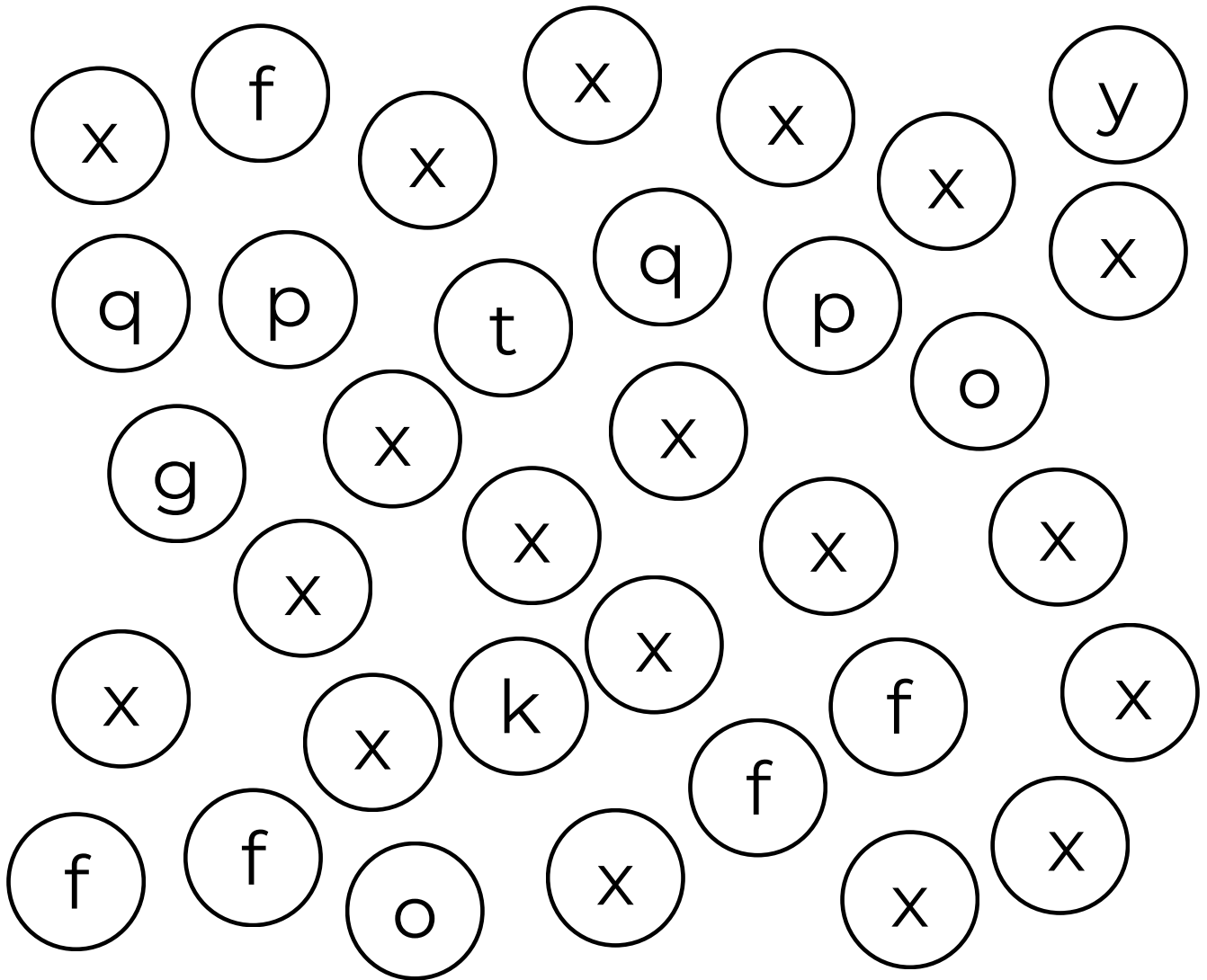

XYLOCOPE / xylocope

(type d'abeille charpentière)

Nom \_\_\_\_\_

Date \_\_\_\_\_

Repasse sur la lettre Y / y

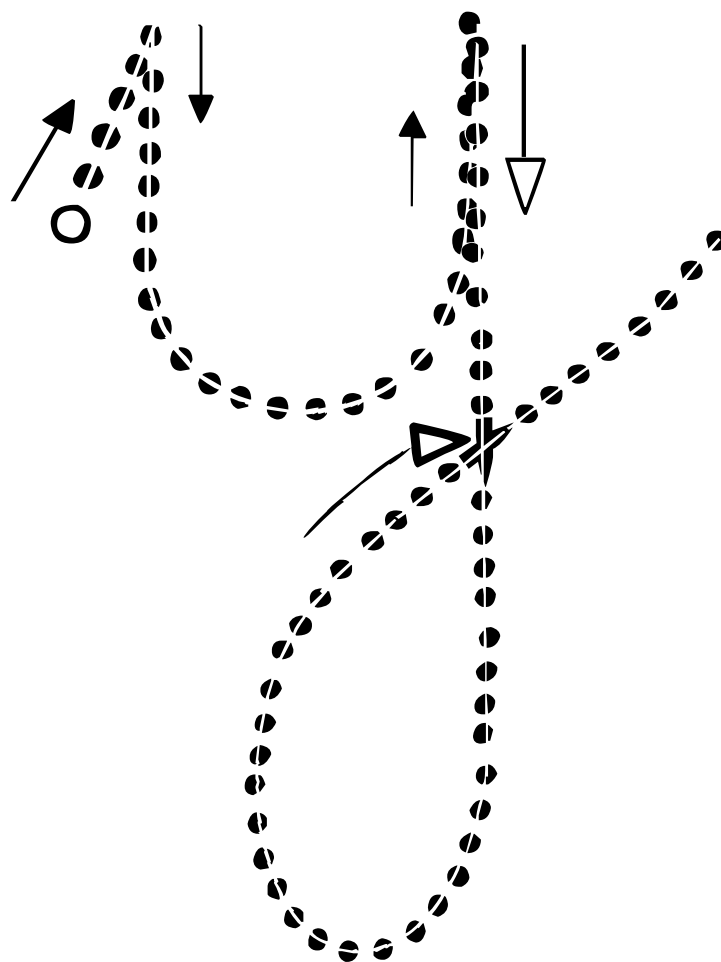

Nom \_\_\_\_\_

Date \_\_\_\_\_

Repasse sur la lettre Y / y

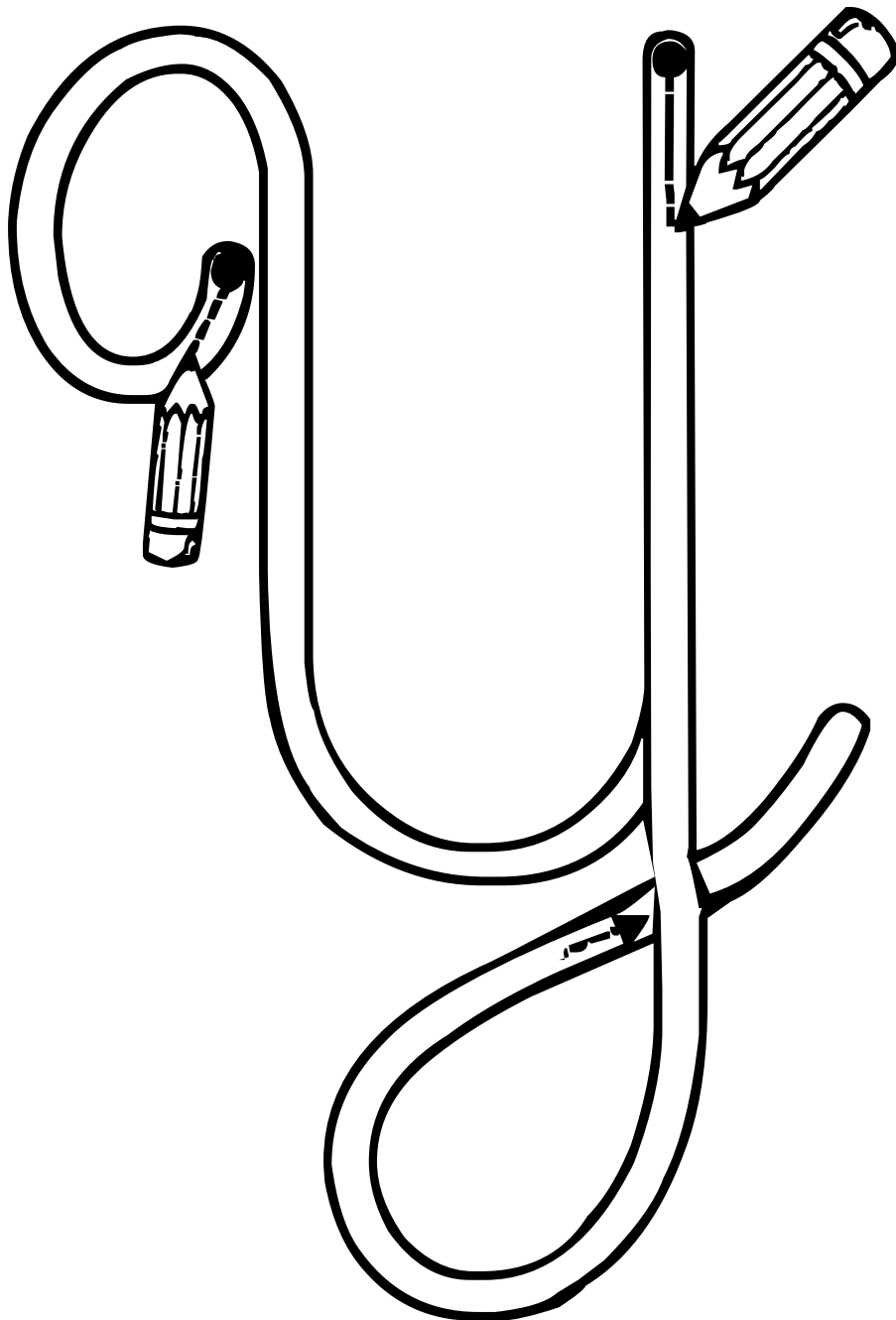

Nom \_\_\_\_\_

Date \_\_\_\_\_

Repasse sur la lettre Y / y

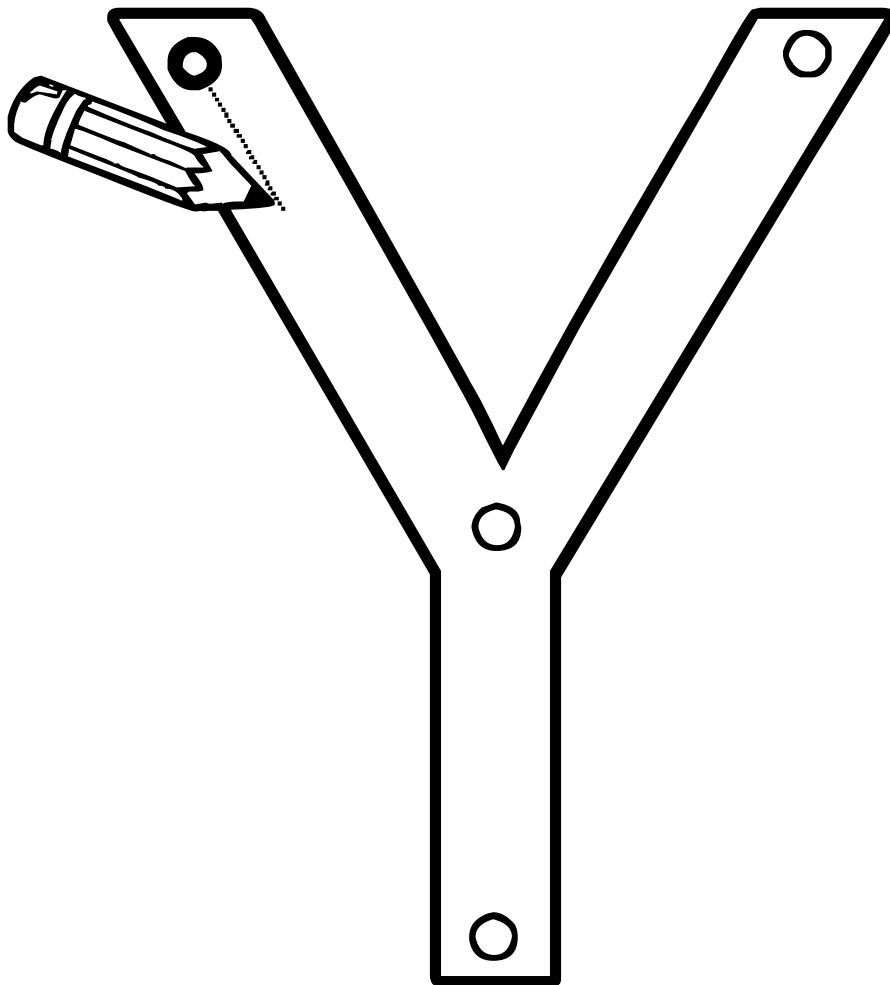

Nom \_\_\_\_\_

Date \_\_\_\_\_

# Ecris la lettre Y / y

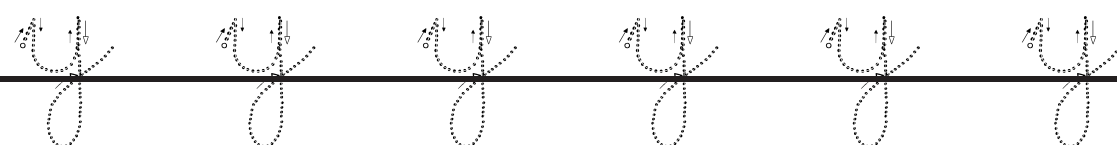
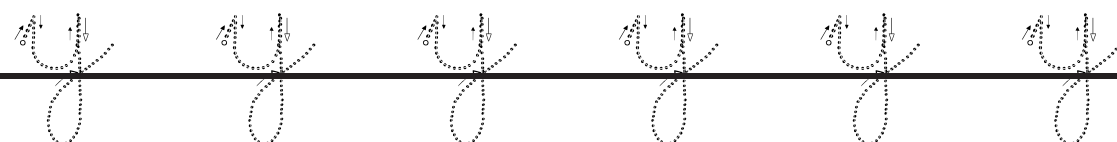
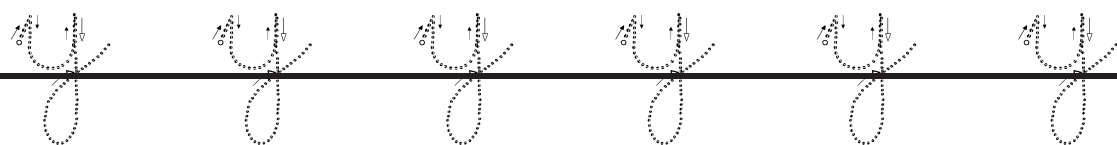
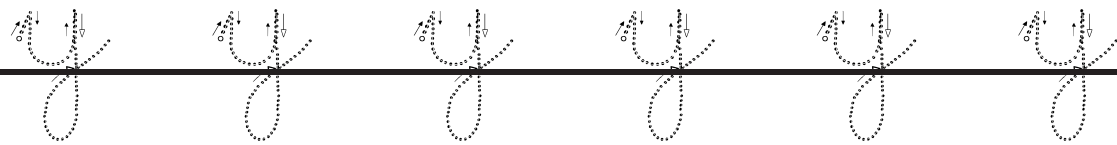
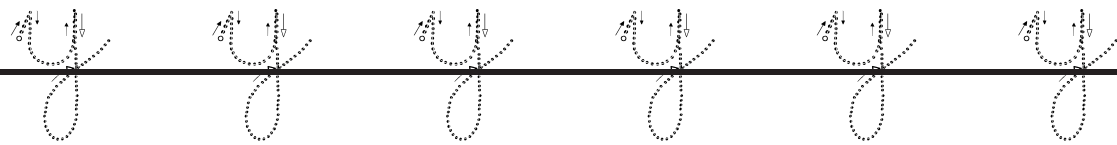
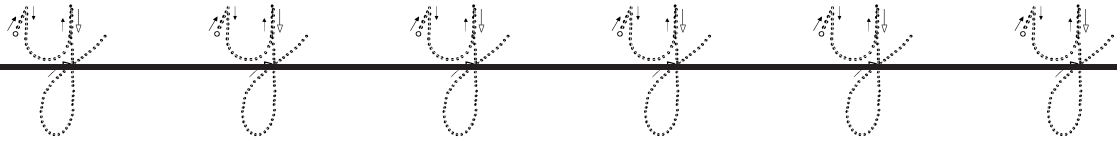

Nom \_\_\_\_\_

Date \_\_\_\_\_

# Ecris la lettre Y / y

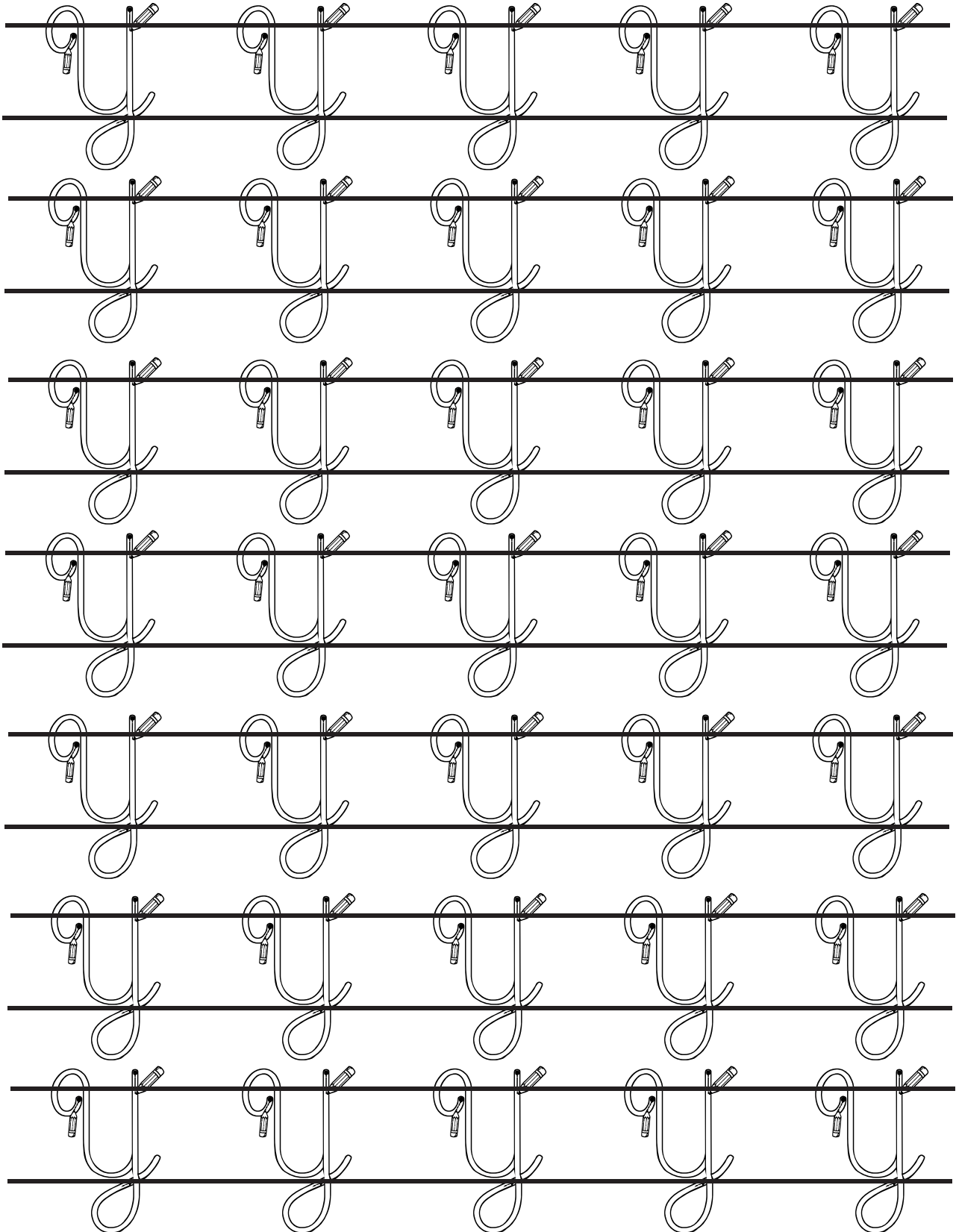

Nom \_\_\_\_\_ Date \_\_\_\_\_

# Ecris la lettre Y/y

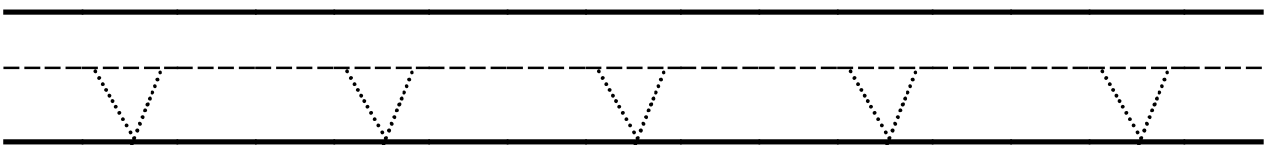
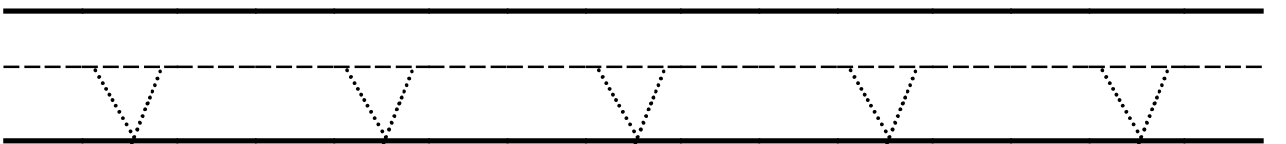
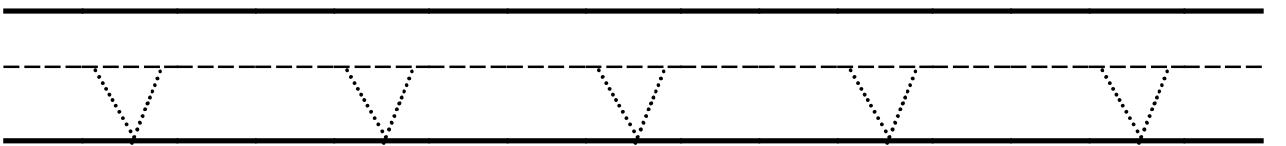
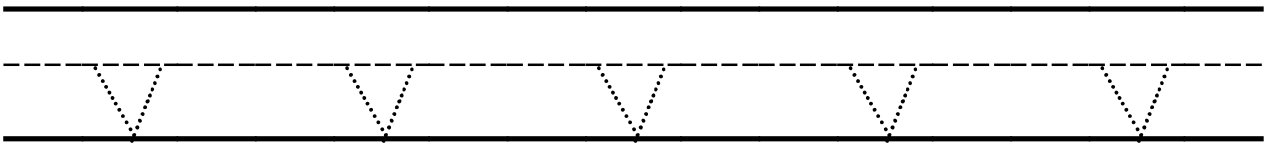
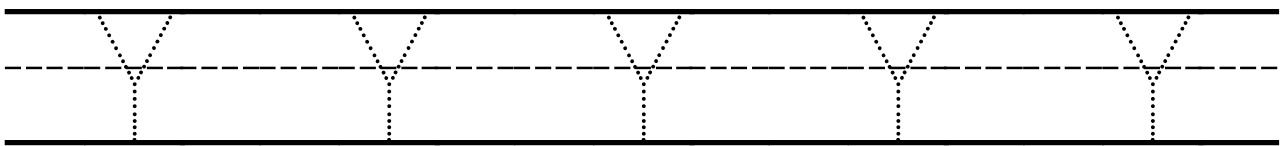
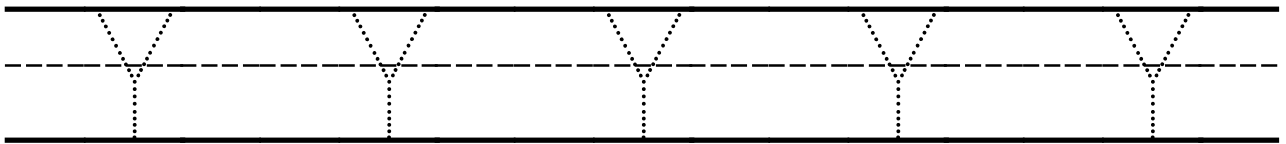
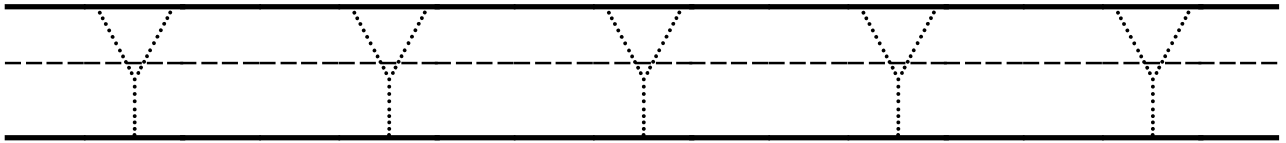
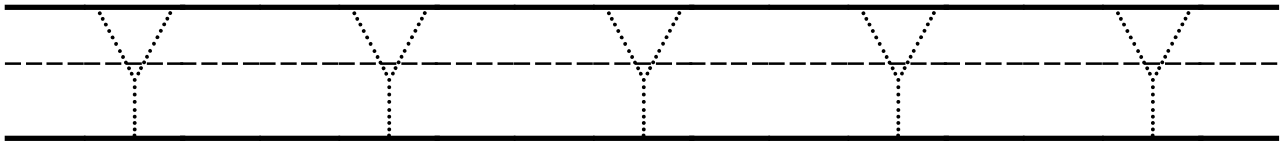

Nom \_\_\_\_\_ Date \_\_\_\_\_

Ecris la lettre Y/y

Y Y Y Y Y

Handwriting practice lines for uppercase 'Y'. Each row consists of a solid top line, a dashed middle line, and a solid bottom line. There are two such rows provided for practice.

y y y y y

Handwriting practice lines for lowercase 'y'. Each row consists of a solid top line, a dashed middle line, and a solid bottom line. There are two such rows provided for practice.

Nom \_\_\_\_\_

Date \_\_\_\_\_

## Colorie la lettre Y

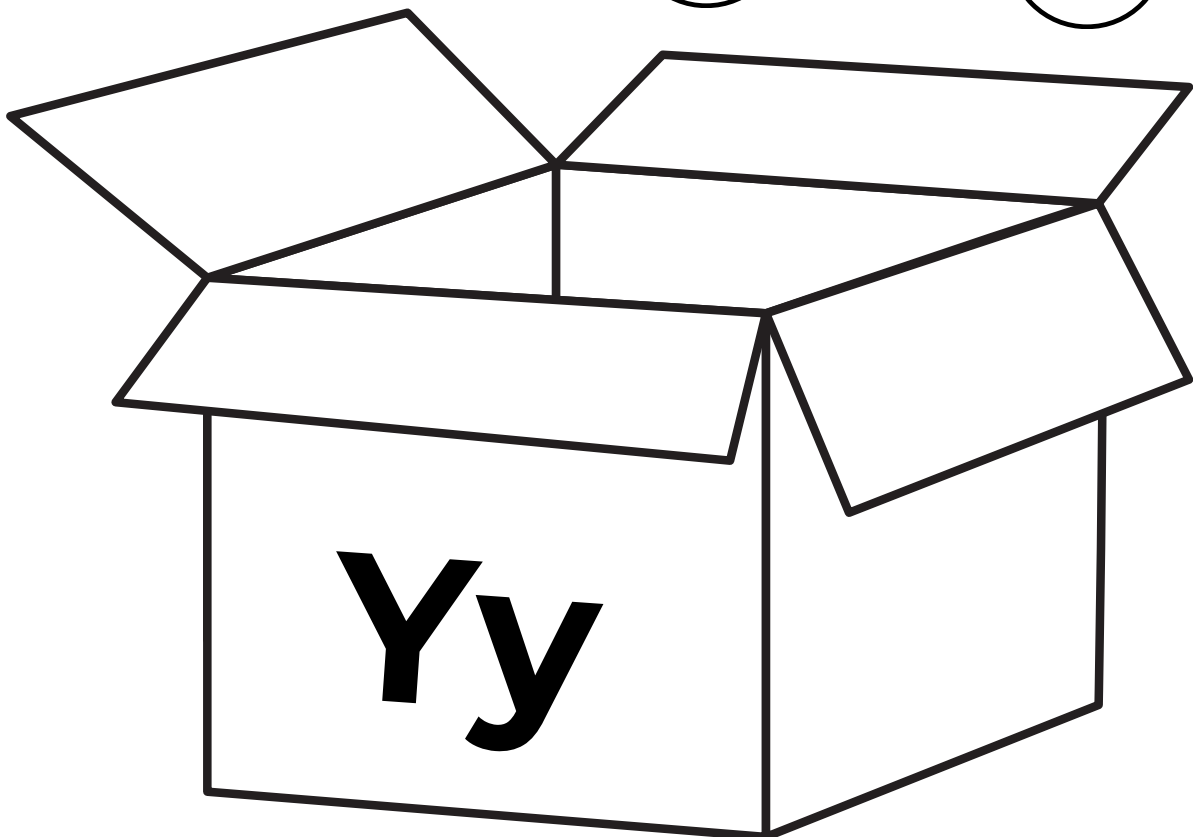
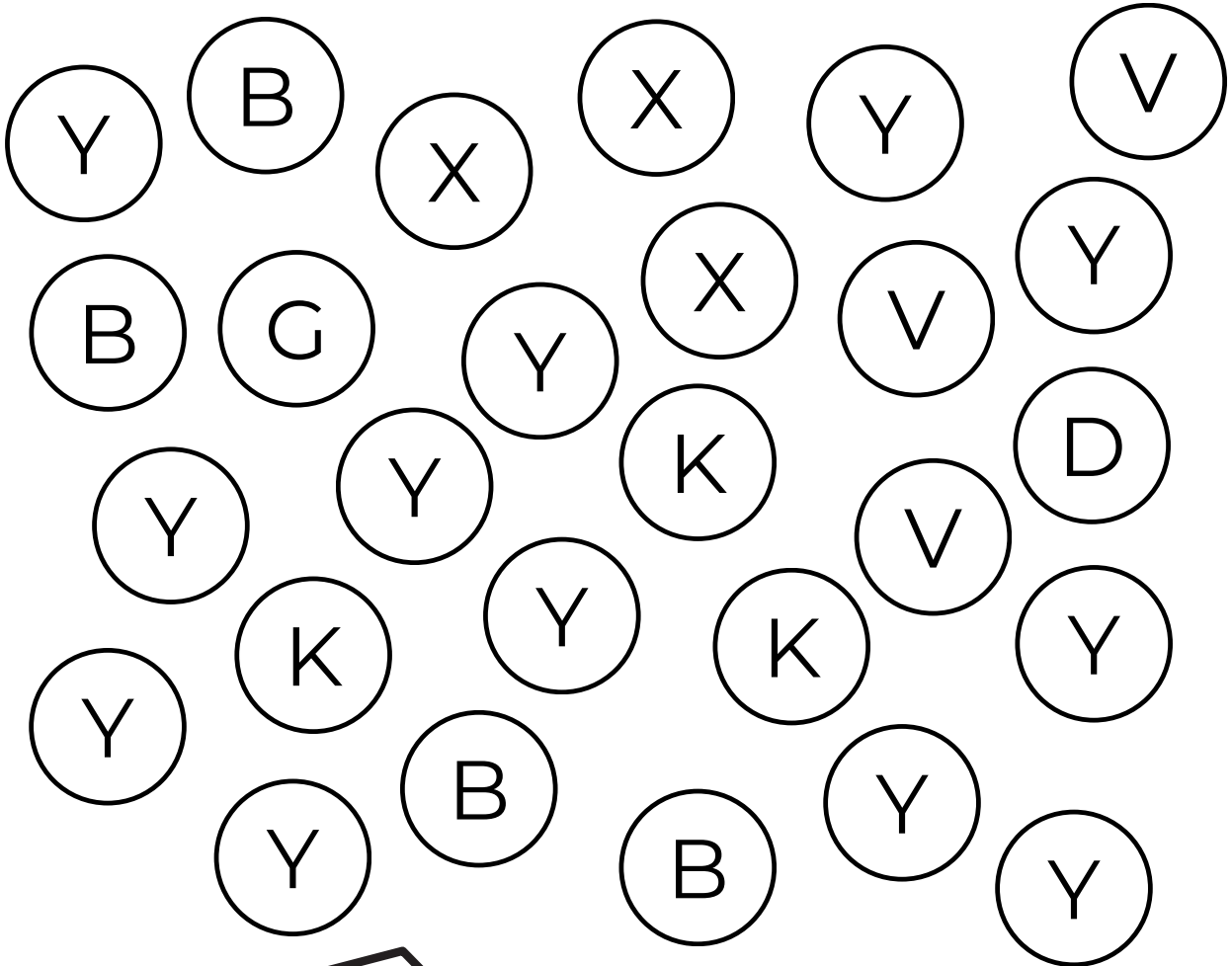

Nom \_\_\_\_\_

Date \_\_\_\_\_

# Colorie la lettre y

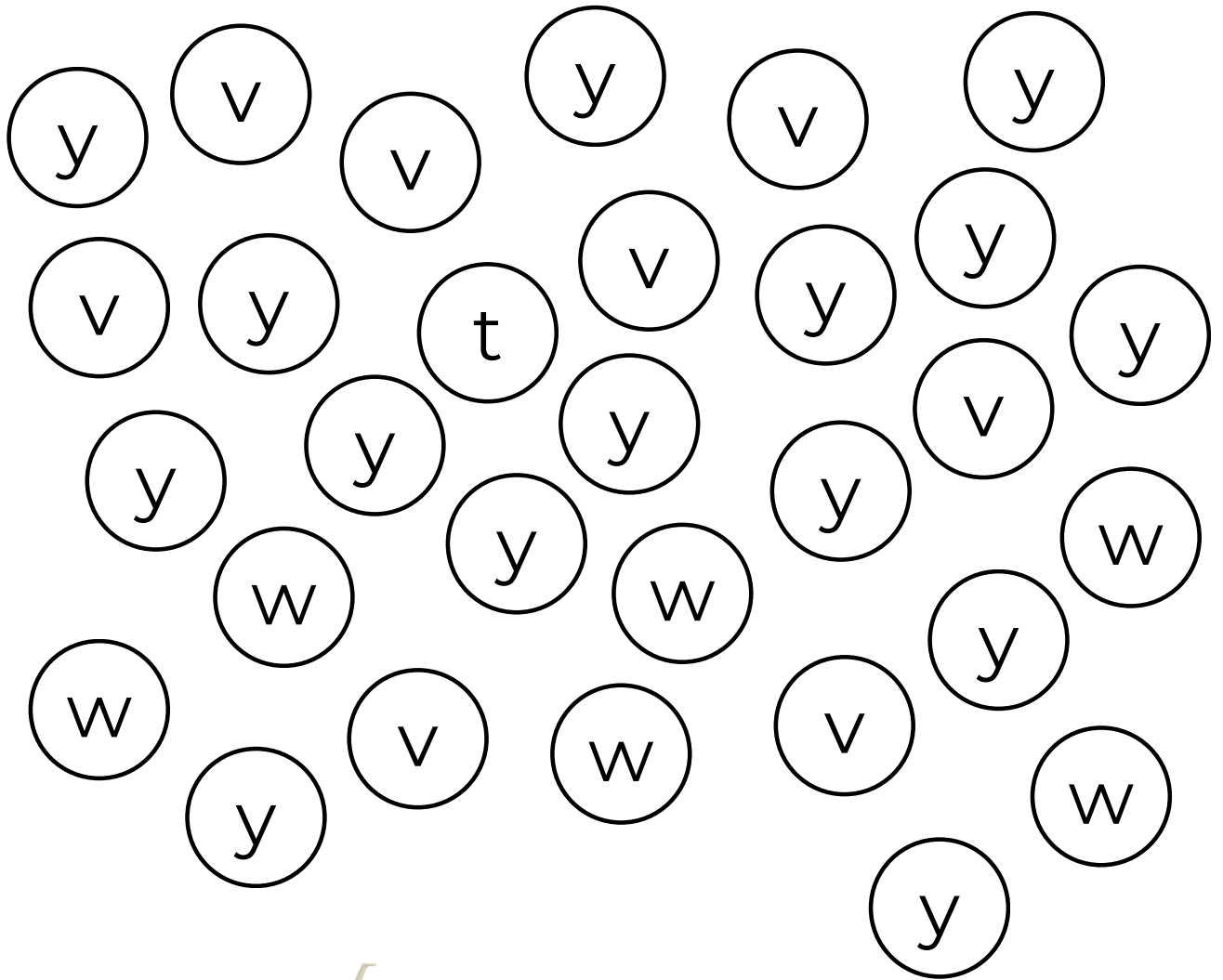

YACHT / yacht  
(petit bateau)

Nom \_\_\_\_\_

Date \_\_\_\_\_

Repasse sur la lettre Z / z

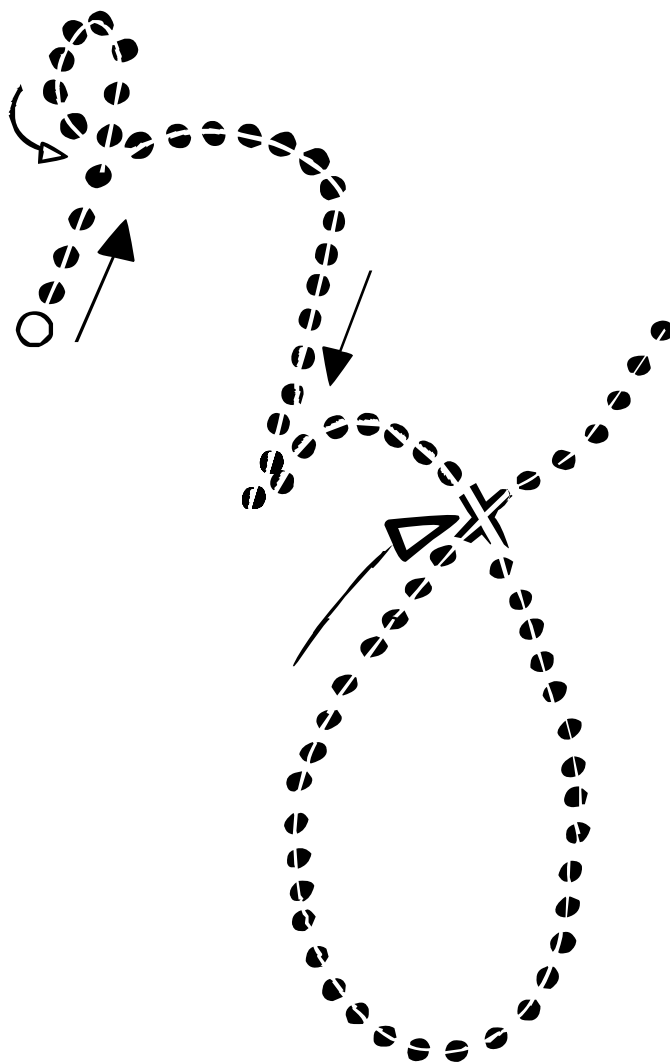

Nom \_\_\_\_\_

Date \_\_\_\_\_

Repasse sur la lettre Z / z

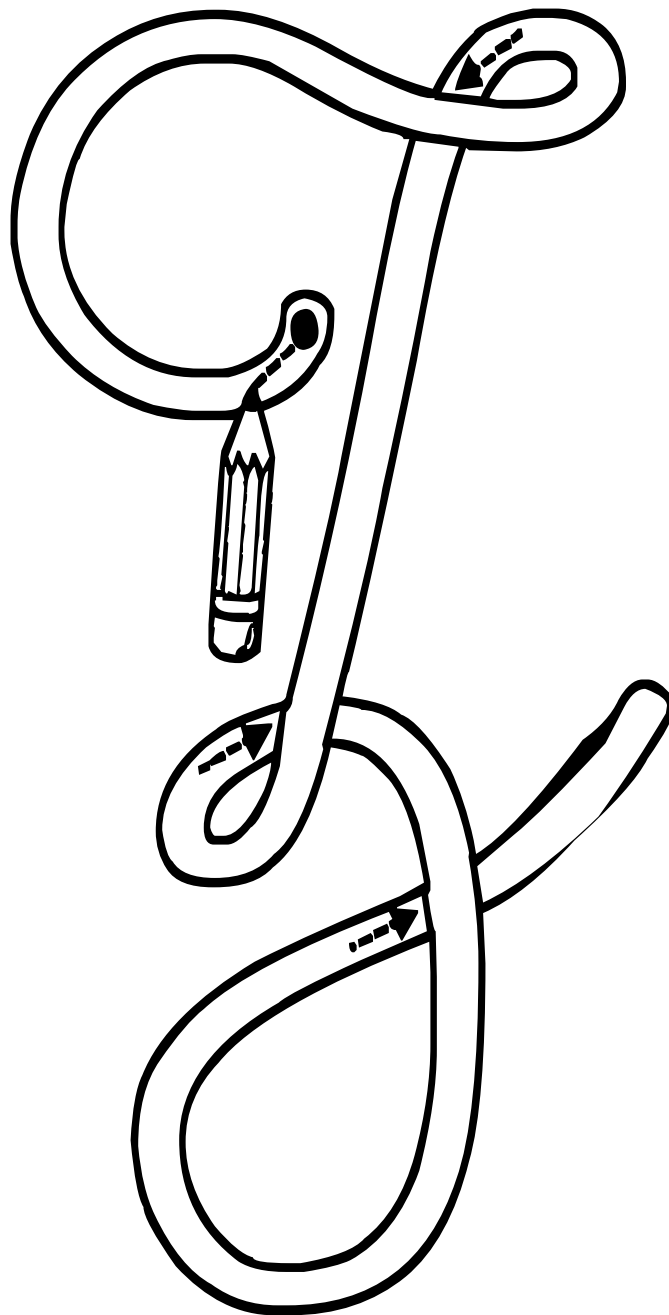

Nom \_\_\_\_\_

Date \_\_\_\_\_

Repasse sur la lettre Z / z

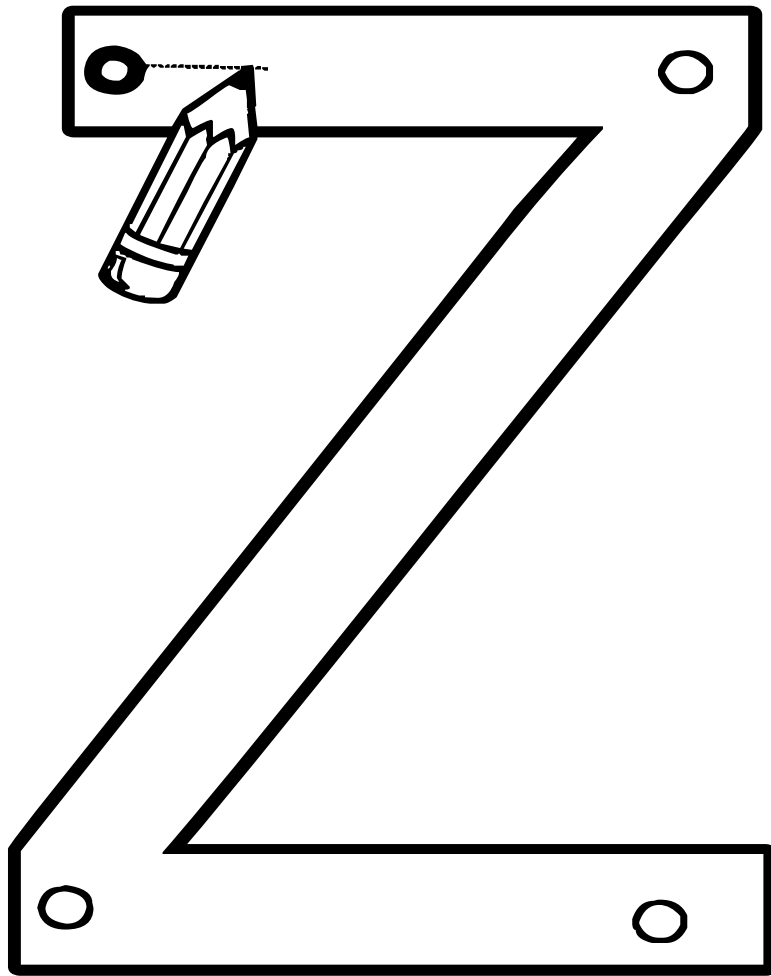

Nom \_\_\_\_\_

Date \_\_\_\_\_

# Ecris la lettre Z / z

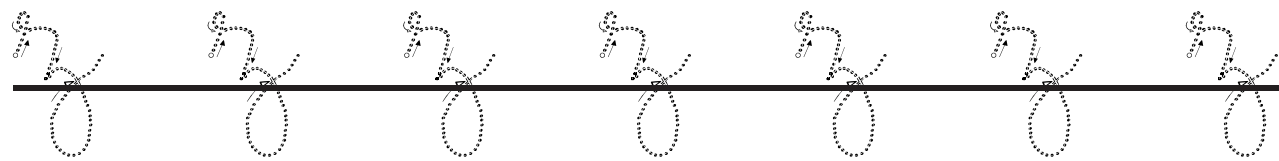
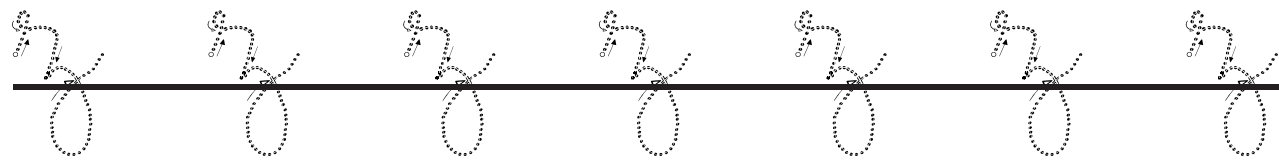
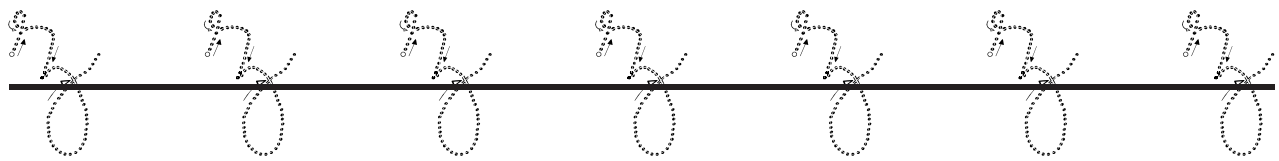
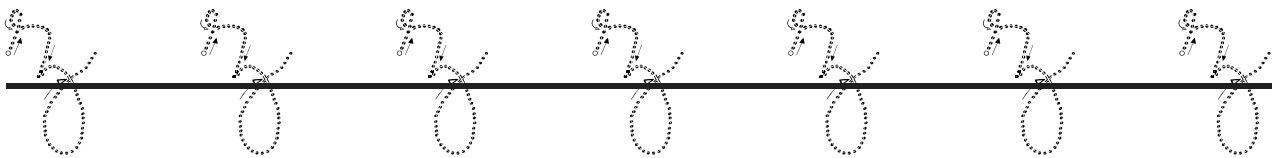
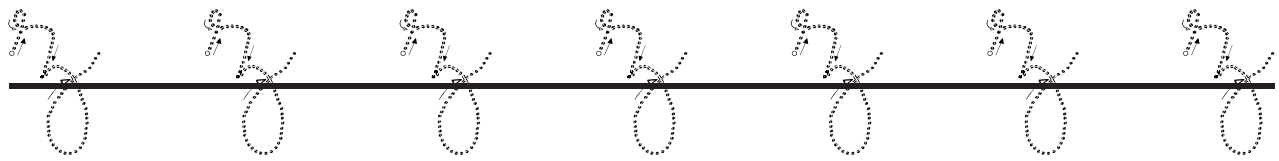
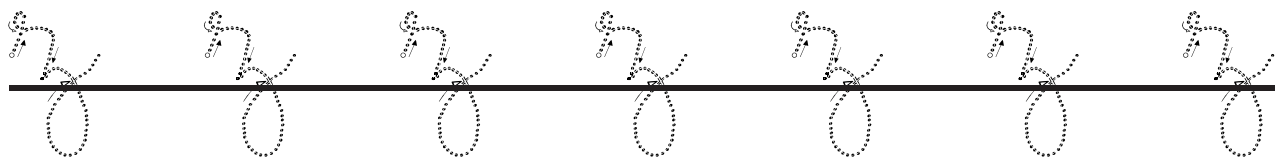
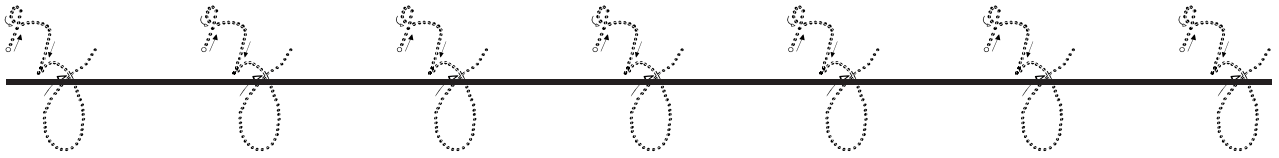

Nom \_\_\_\_\_

Date \_\_\_\_\_

# Ecris la lettre Z / z

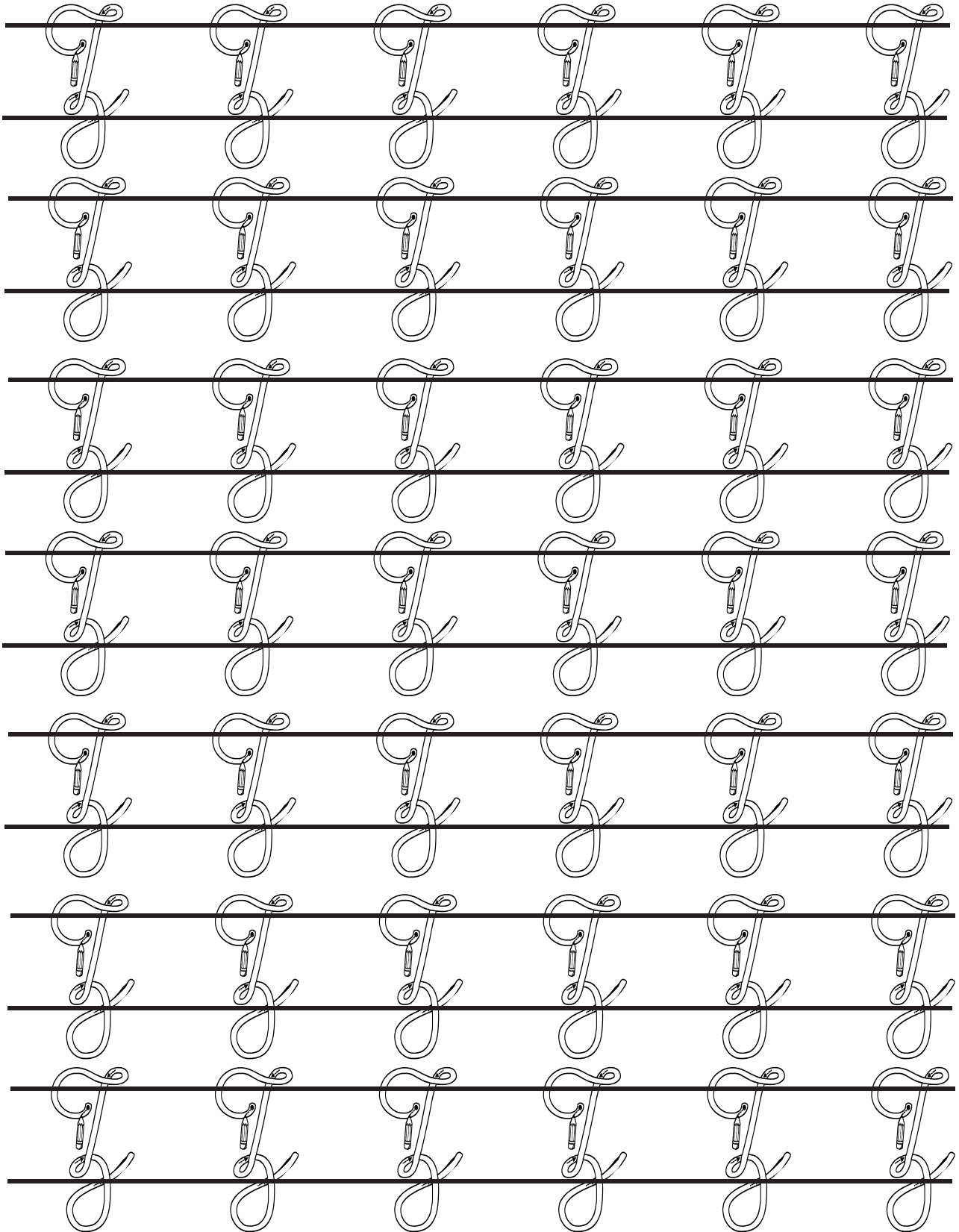

Nom \_\_\_\_\_

Date \_\_\_\_\_

# Ecris la lettre Z/z

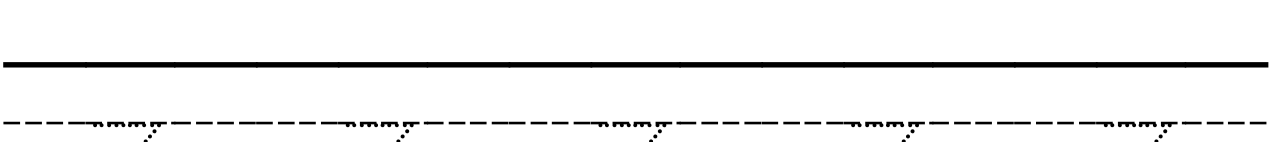
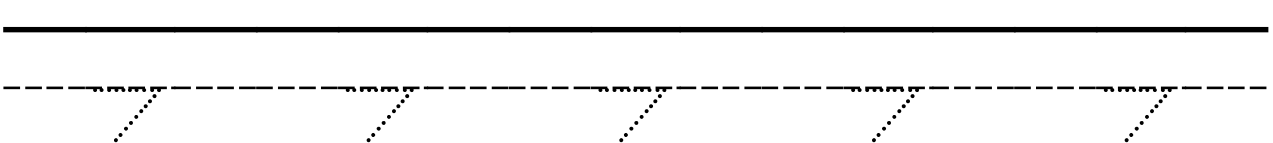
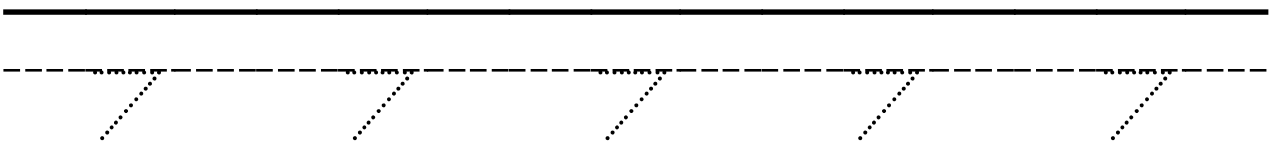
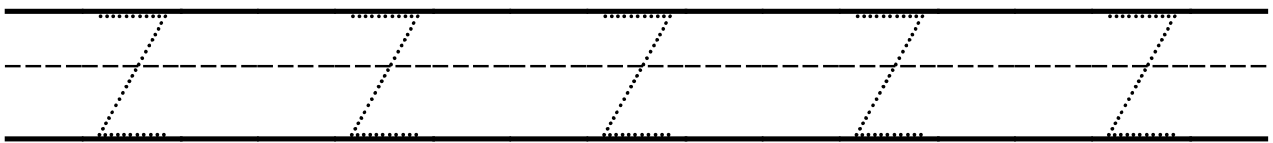
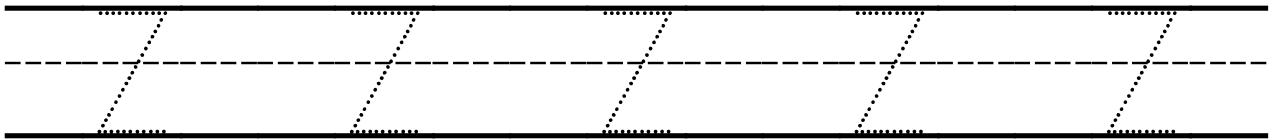
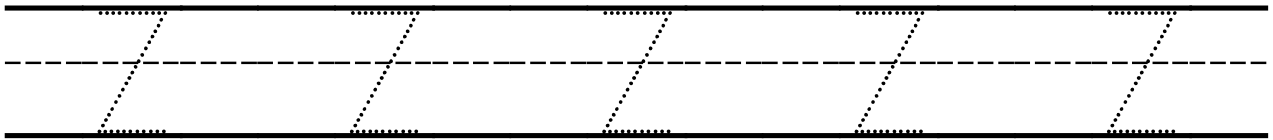
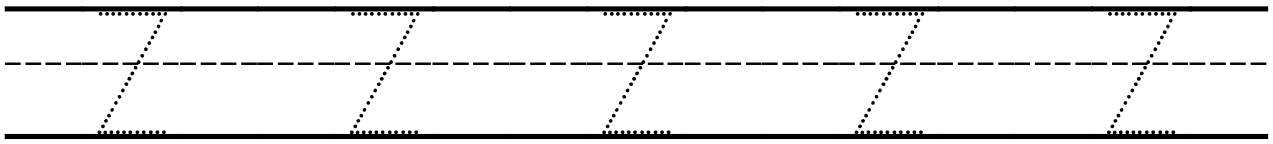

Nom \_\_\_\_\_ Date \_\_\_\_\_

Ecris la lettre Z/z

Z Z Z Z Z

Handwriting practice lines for uppercase Z. Each row consists of a solid top line, a dashed middle line, and a solid bottom line.

z z z z z

Handwriting practice lines for lowercase z. Each row consists of a solid top line, a dashed middle line, and a solid bottom line.

Nom \_\_\_\_\_

Date \_\_\_\_\_

### Colorie la lettre Z

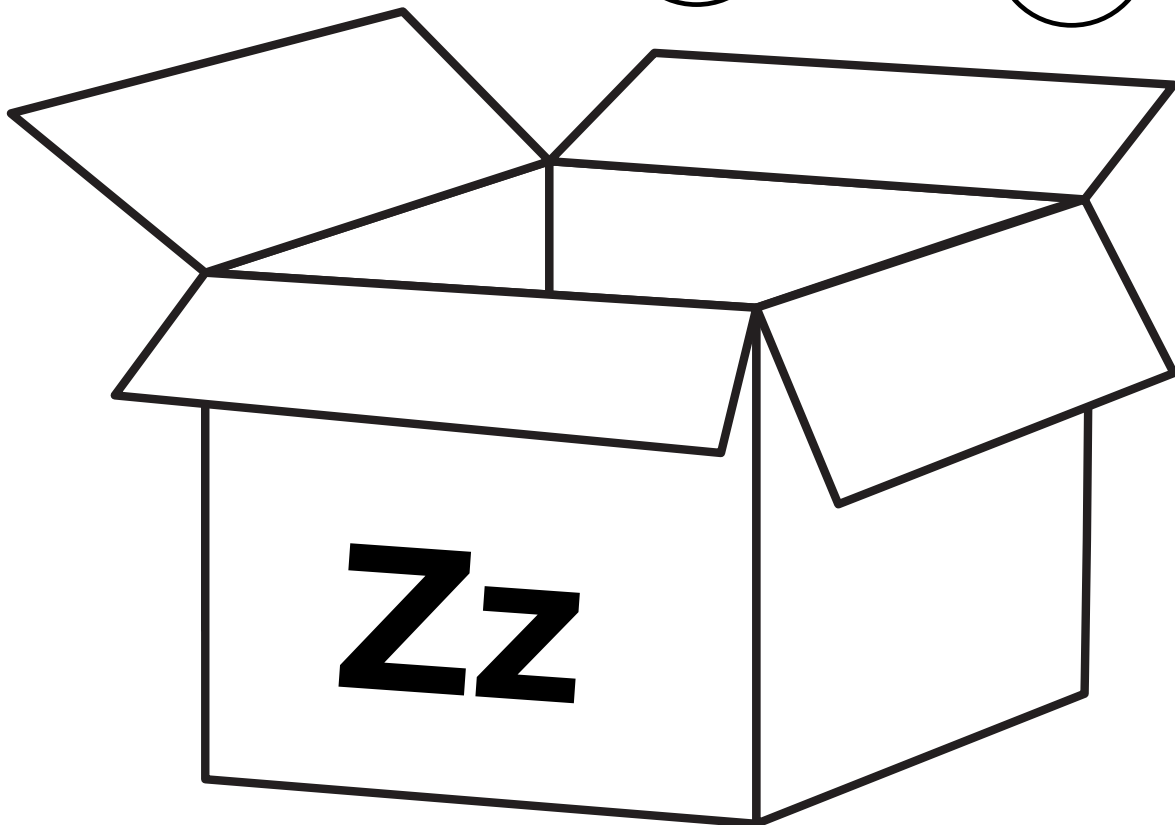
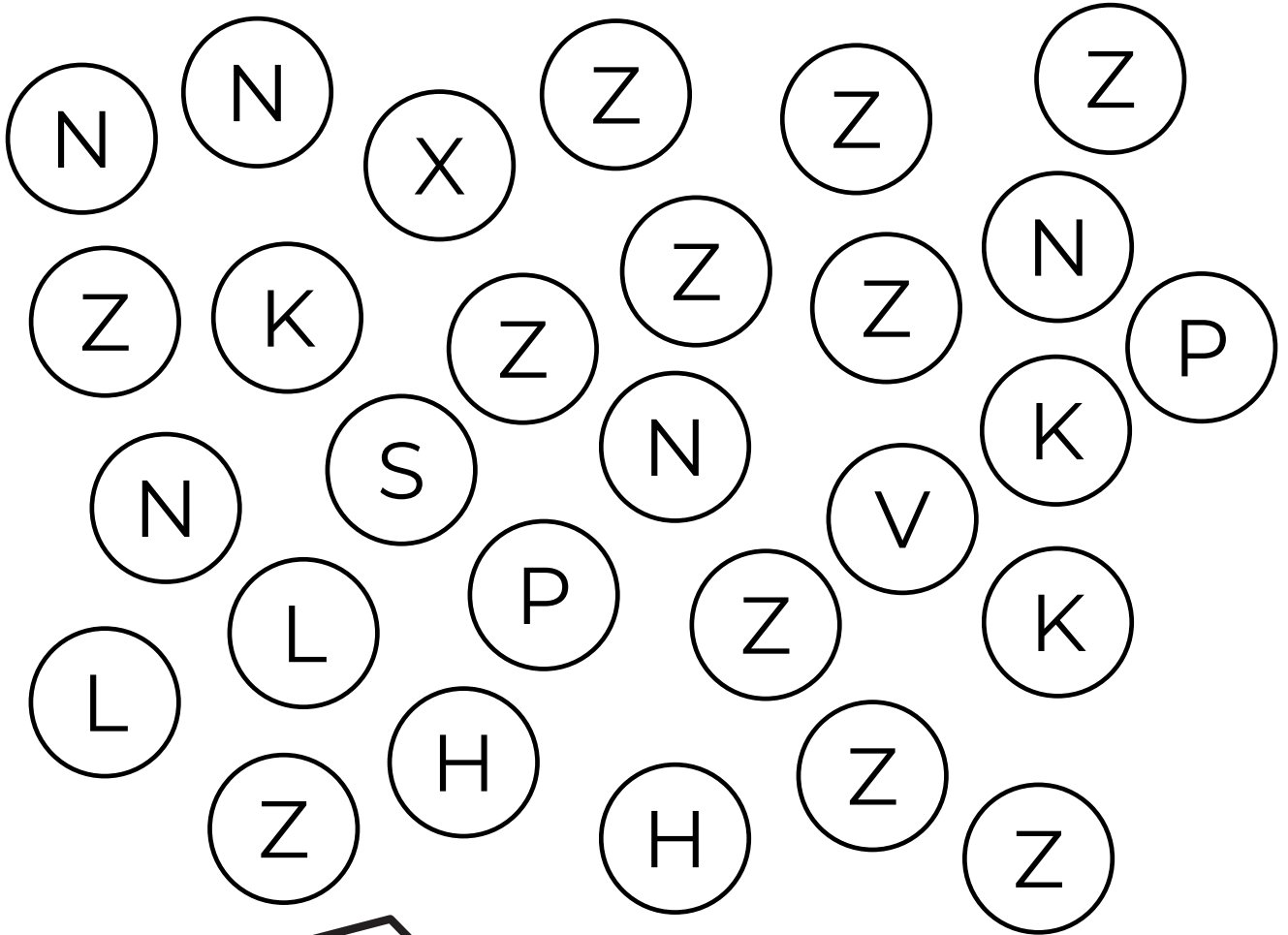

Nom \_\_\_\_\_

Date \_\_\_\_\_

## Colorie la lettre z

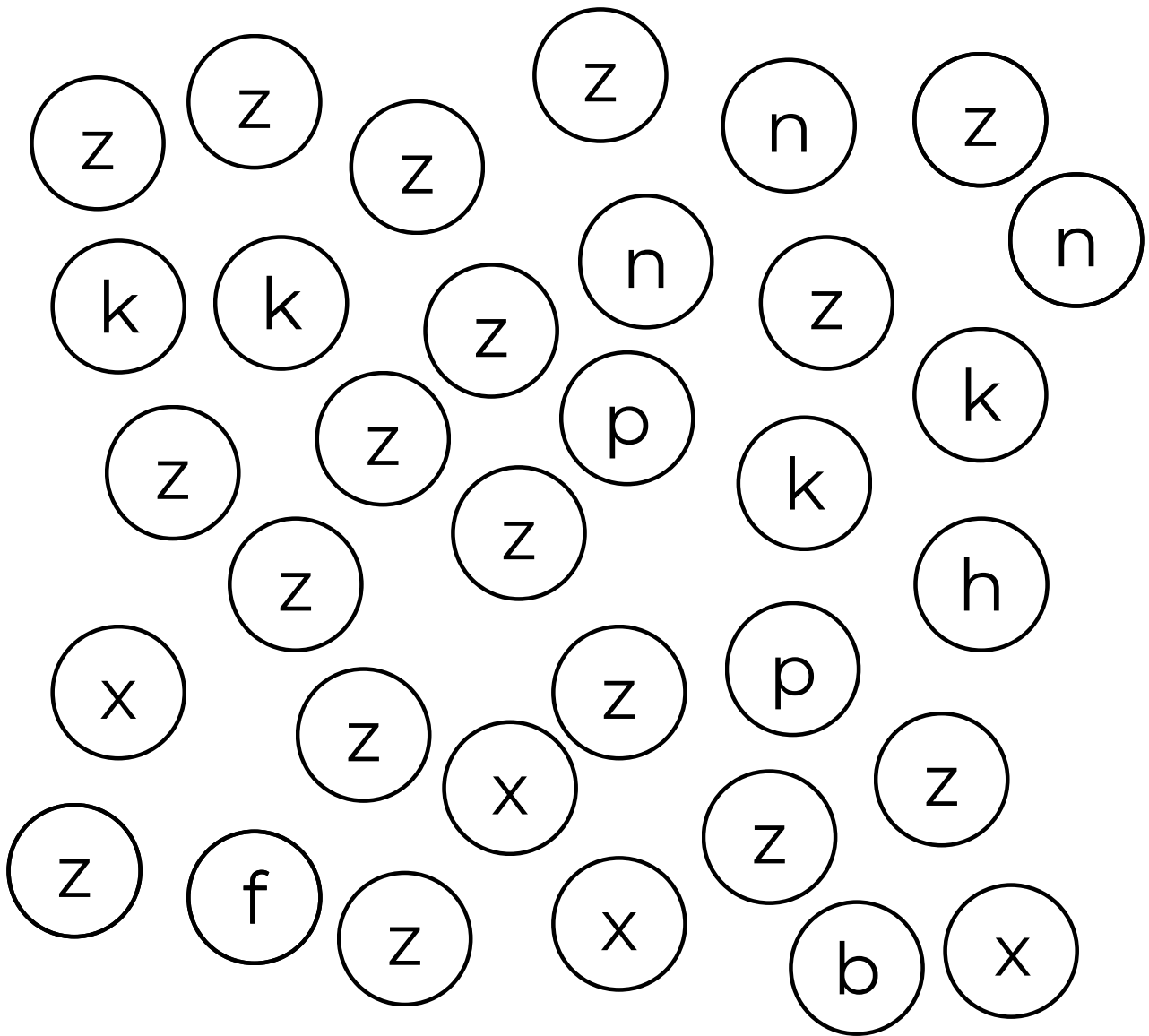

ZENITH / zénith









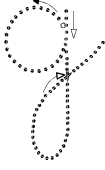
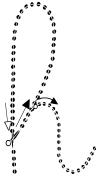
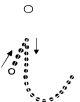

Nom \_\_\_\_\_

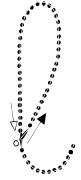
Date: \_\_\_\_\_

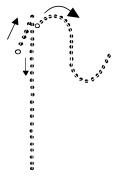
# MON ALPHABET

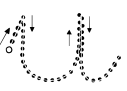
Repasse sur les lettres de l'alphabet

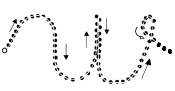
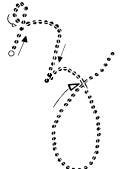

Nom \_\_\_\_\_

Date: \_\_\_\_\_

# MON ALPHABET

Repasse sur les lettres de l'alphabet

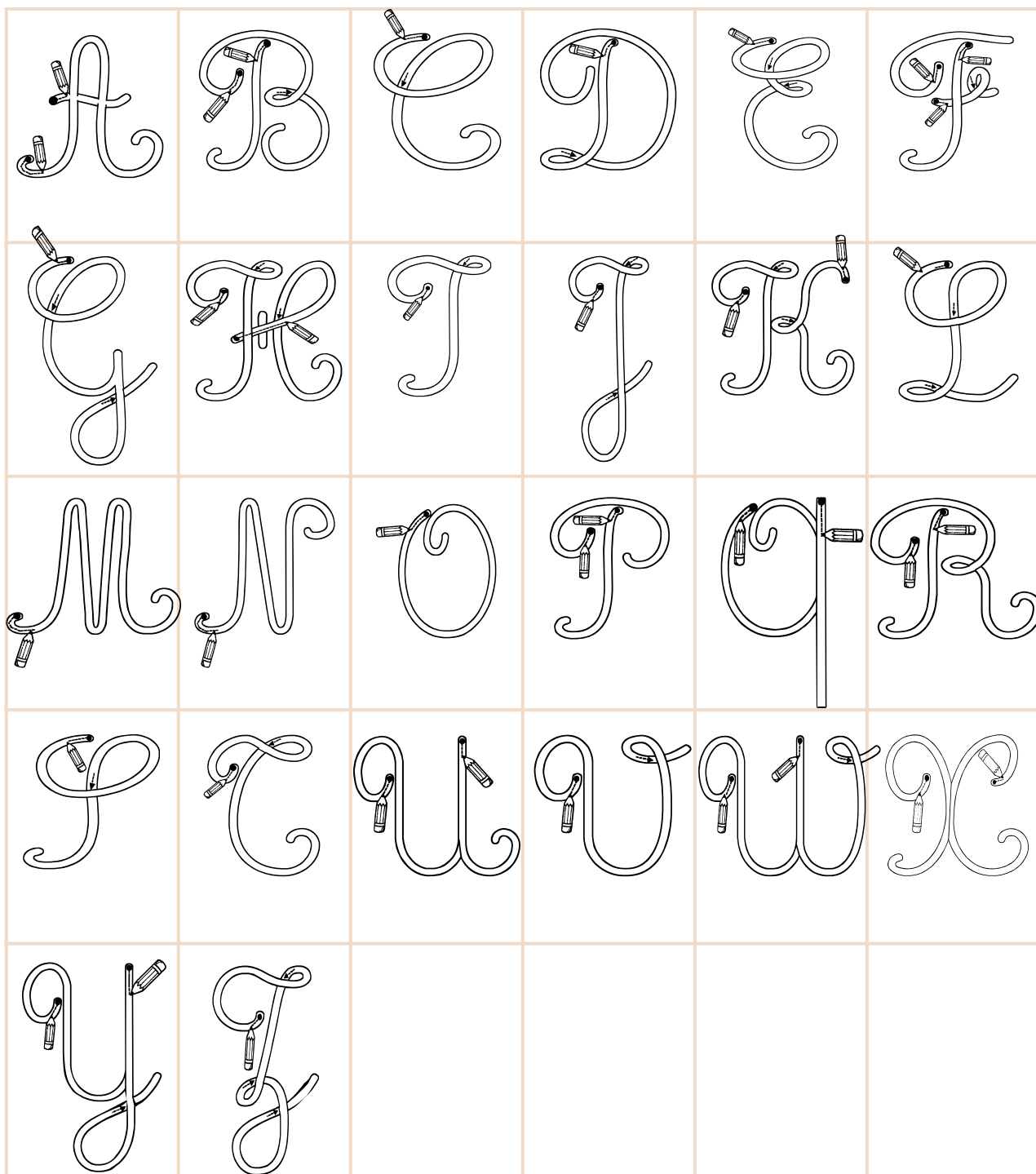

Nom \_\_\_\_\_

Date: \_\_\_\_\_

# MON ALPHABET

Repasse sur les lettres de l'alphabet

A	B	C	D	E	F
G	H	I	J	K	L
M	N	O	P	Q	R
S	T	U	V	W	X
Y	Z				

Nom \_\_\_\_\_

Date: \_\_\_\_\_

# MON ALPHABET

Repasse sur les lettres de l'alphabet

a	b	c	d	e	f
g	h	i	j	k	l
m	n	o	p	q	r
s	t	u	v	w	x
y	z				

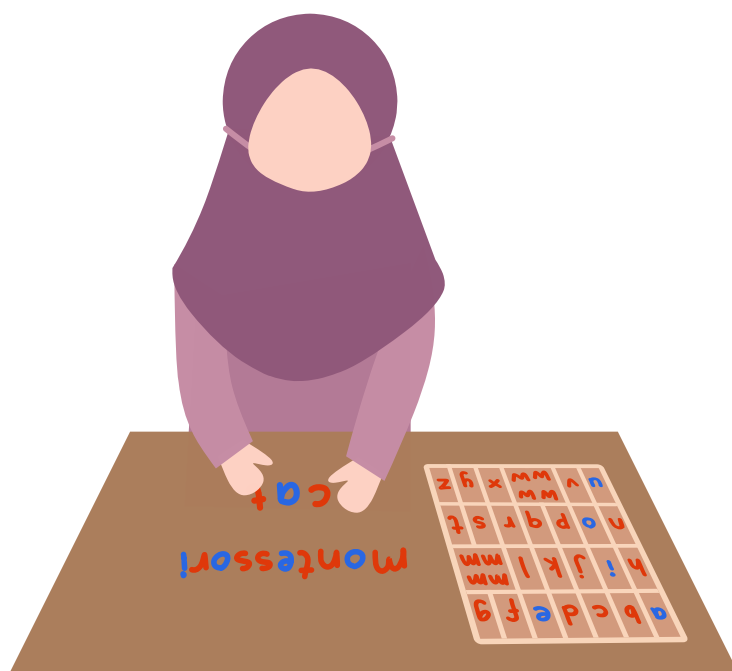

Toute reproduction totale ou partielle est strictement interdite. Toute diffusion de l'œuvre hors cadre privé est interdite sans autorisation des éditions Ummaty Books

**Septembre 2023 - Edition Ummaty Books**  
**ISBN 978-2-490990-08-5**

Loi n°49-956 de 16 juillet 1949 sur les publications destinées à la jeunesse modifiée par la loi n°2011-525 du 17 mai 2011



# CERTIFICAT DE RÉUSSITE

décerné à :

---

pour son travail assidu tout au long de ce livret et  
pour son excellente connaissance de l'alphabet

