

5-8
ans

inspiré de la pédagogie

MONTESSORI

MON MANUEL D'ÉCRITURE

J'APPRENDS L'ALPHABET

AVEC LES MOTS DE L'ISLAM

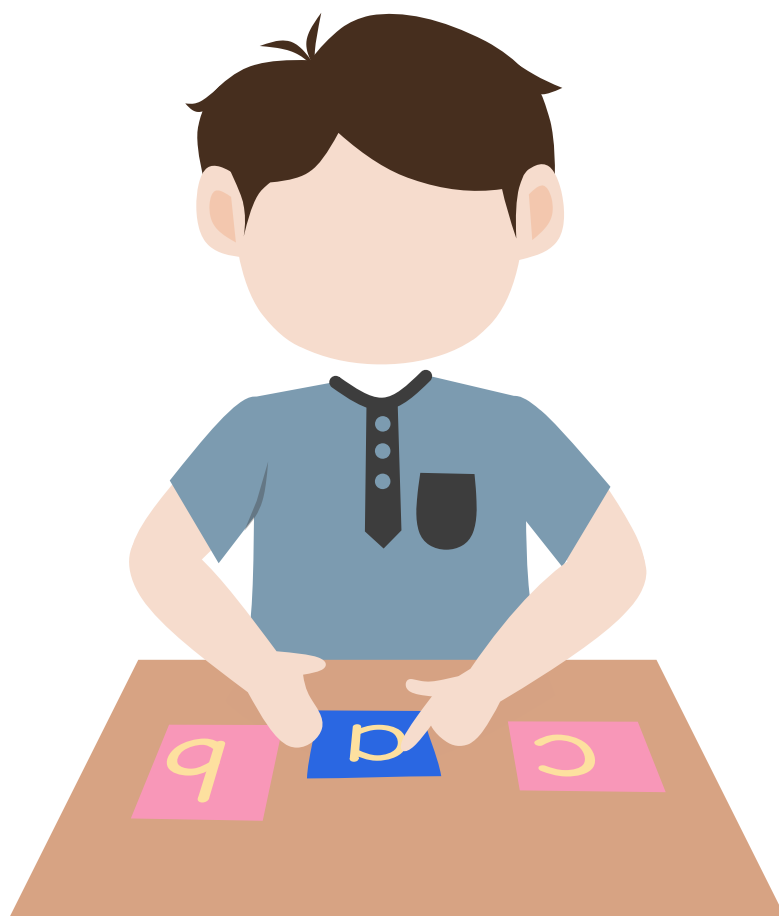

ummatyshop 

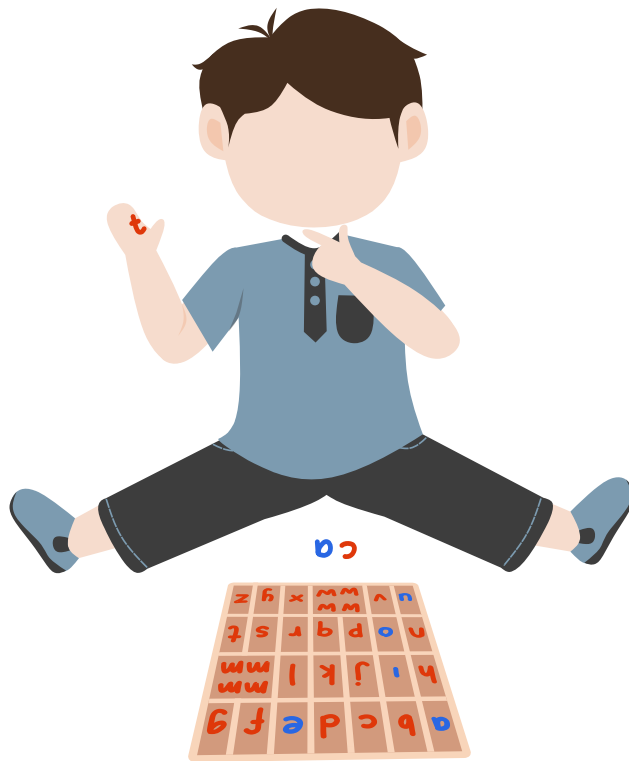

J'APPRENDS L'ALPHABET

AVEC LES MOTS DE L'ISLAM

Imaginé par *Adam & Oum Adam*
Conceptualisé par *Abou & Oum Adam*
Réalisé par *Adam & Oum Adam*

CONSEILS PÉDAGOGIQUES POUR UNE UTILISATION RÉUSSIE DU MANUEL

Bienvenue dans le manuel d'écriture
**"J'apprends l'alphabet avec les mots de
l'islam"** conçu pour les enfants de 5 à 8 ans.

Ce support éducatif a été inspirée par la
pédagogie Montessori.

Oum Adam, enseignante en FLE et maman
en IEF depuis 2012, accompagné d'Adam -
collégien en IEF et multi-dys, ont élaboré ce
manuel dans l'objectif de rendre
l'apprentissage de l'alphabet français
instructif, ludique et adapté aux besoins
individuels de chaque enfant.

Pour vous aider à prendre main les activités
proposées, et afin d'en tirer tous les
bénéfices, **voici quelques conseils utiles à
lire avant de débiter avec votre Minimuz.**

LA PÉDAGOGIE MONTESSORI DANS NOTRE MANUEL D'ÉCRITURE

1. Apprentissage individualisé :

Avec la pédagogie Montessori, chaque enfant progresse à son propre rythme. Notre manuel d'écriture s'adapte à cette approche en permettant aux enfants de s'engager avec les lettres à leur propre vitesse, en fonction de leurs besoins et de leurs compétences.

2. Favorise l'autonomie :

La pédagogie Montessori encourage les enfants à devenir autonomes dans leur apprentissage. Notre manuel pédagogique permet à l'enfant de choisir des activités d'écriture qui l'intéressent et de travailler de manière autonome quand il le souhaite.

3. Utilisation de matériel sensoriel :

La méthode Montessori met l'accent sur l'utilisation de matériel sensoriel concret pour faciliter l'apprentissage. Notre manuel d'écriture incorpore donc des photographies réelles - et non des illustrations, ce qui permet aux enfants d'associer visuellement les lettres et les mots aux objets du monde réel. Cela favorise une compréhension plus profonde et un apprentissage plus engageant.

4. Encourage la créativité :

La pédagogie Montessori laisse place à la créativité et à l'exploration. En s'inspirant de notre manuel d'écriture, l'enfant peut tracer les lettres dans le sable par exemple. Vous pouvez également plastifier les lettres afin de les réutiliser, ou de faire travailler l'enfant avec des jouets, de la pâte à modeler ou autre avant de passer à l'outil scripteur. LA seule limite est votre imagination (et celle de votre petit bout).

5. Accélérer l'apprentissage de la lecture :

L'approche Montessori se base sur le son des lettres et non le nom de celles-ci. de cette façon, nous avons choisi, pour chaque lettre, un mot qui débute par le son réel de la lettre. Par exemple, Coran pour C et non Cheval ou Citron. Pensez à bien répéter à l'enfant le son de la lettre au lieu de son nom. Ceci facilitera son entrée en lecture.

6. Initiation à l'Islam :

Le manuel d'écriture "J'apprends l'alphabet avec les mots de l'islam" offre une occasion unique d'introduire le vocabulaire de l'Islam dès le plus jeune âge. Ainsi, pour chaque lettre, nous avons choisi un mot en lien avec l'Islam afin que l'enfant puisse les découvrir et les comprendre.

7. Amusez vous :

Pas de pression ! Le but de ce manuel est de passer un moment ludique et agréable !

Qui sommes-nous ?

Depuis 10 ans, la team Ummaty œuvre pour l'instruction et l'éducation des enfants.

Oum Adam, enseignante de FLE et maman IEF depuis 2012, a mis son expertise à votre service en élaborant ce manuel.

Mais, ce n'est pas tout, puisque, Adam - collégien en IEF et multi-dys, a également mis la main à la pâte pour vous proposer un support qui réponde parfaitement aux attentes de vos enfants (et aux vôtres).

Enfin, Abou Adam, co-fondateur d'Ummaty Shop et père de famille nombreuse en école à la maison, a, quant à lui, participé à la conceptualisation de ce manuel. Ceci, comme à son habitude pour chaque support proposé par Ummaty Shop et l'édition Ummaty Books depuis une décennie.

Nous espérons que notre travail vous plaira !

Ce manuel appartient à :

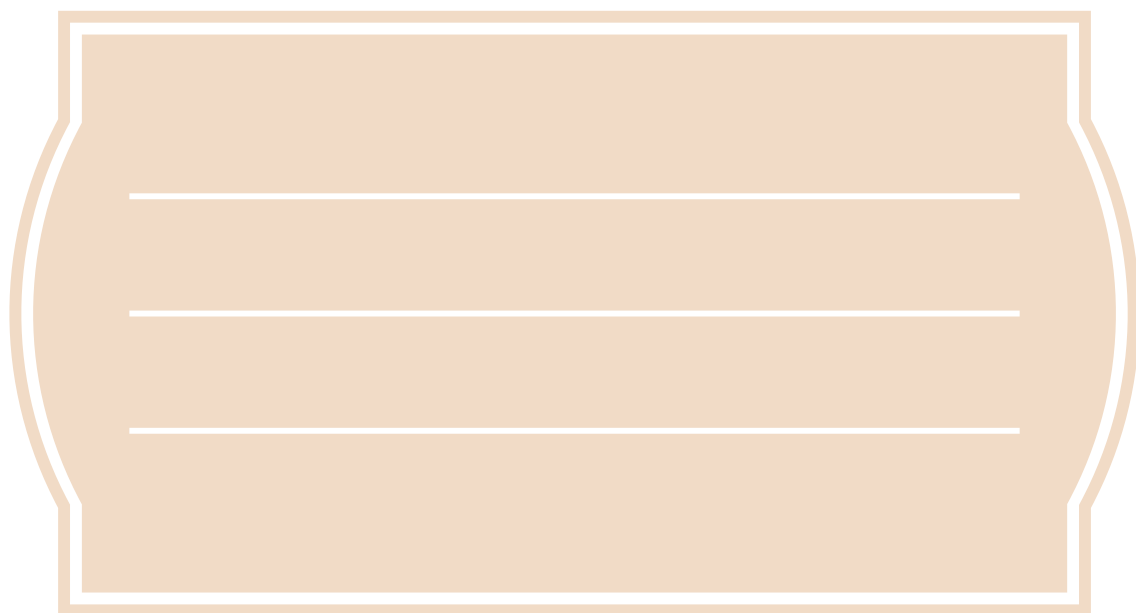

A decorative rectangular box with rounded corners and a double border, containing three horizontal lines for writing.

Nom: _____ Date: _____

QUI SUIS-JE ?

Mon prénom est :

Voici les lettres de mon prénom :

a	b	c	d	e	f	g
h	i	j	k	l	m	n
o	p	q	r	s	t	u
v	w	x	y	z		

Que signifie mon prénom ?

Nom _____

Date _____

Repasse sur la lettre A / a

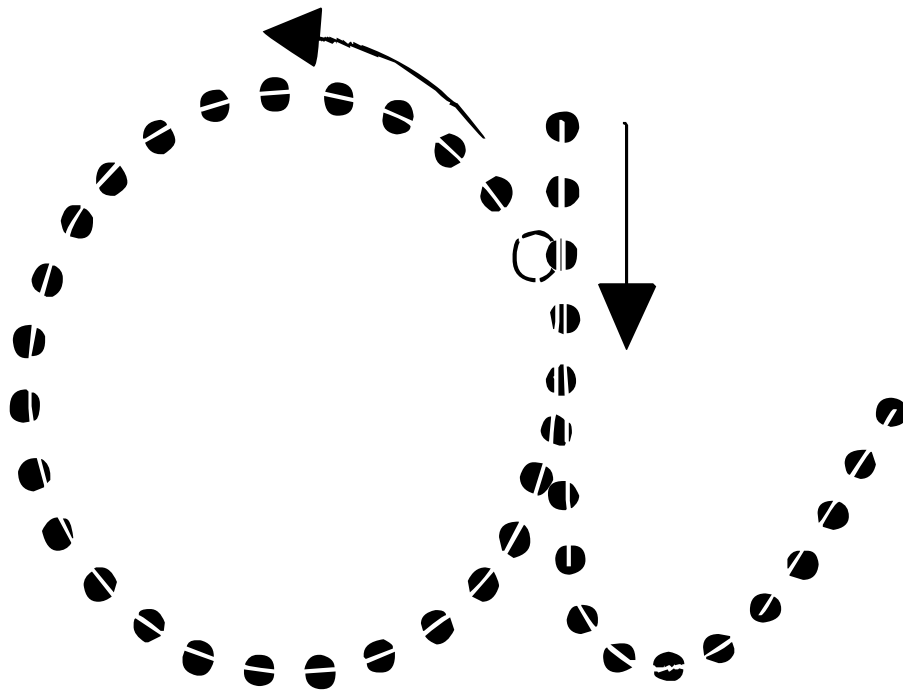

Nom _____

Date _____

Repasse sur la lettre A / a

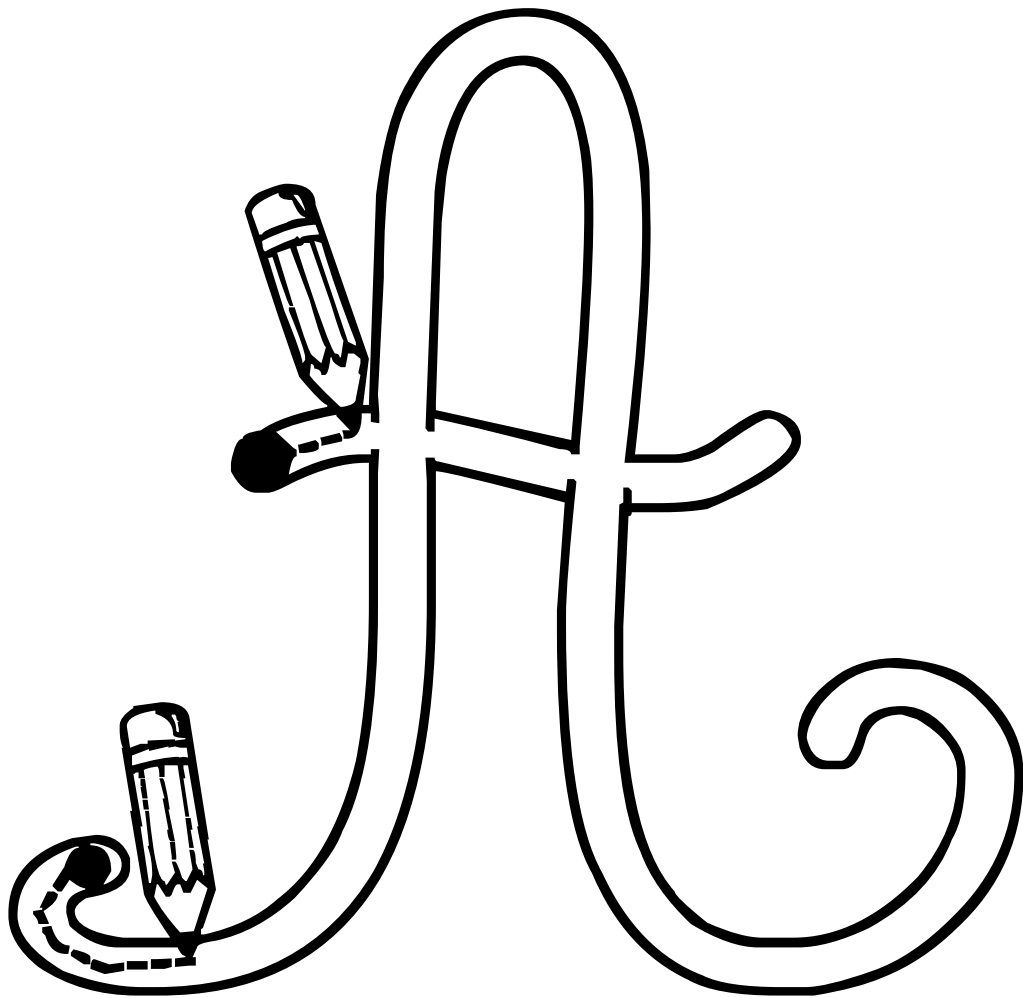

Nom _____

Date _____

Repasse sur la lettre A / a

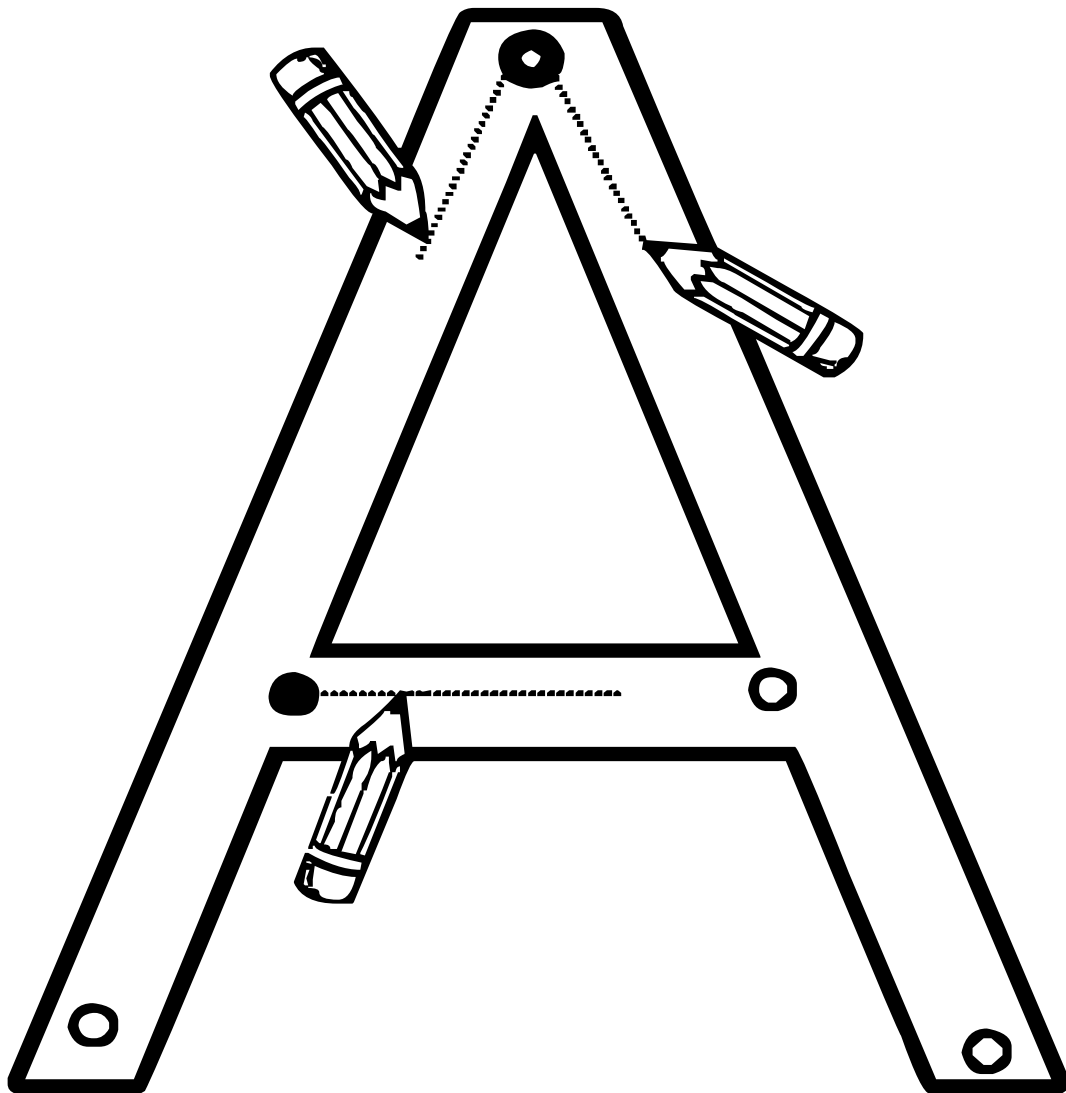

Nom _____ Date _____

Ecris la lettre A / a

a a a a a a a

a a a a a a a

a a a a a a a

a a a a a a a

a a a a a a a

a a a a a a a

a a a a a a a

Nom _____

Date _____

Ecris la lettre A / a

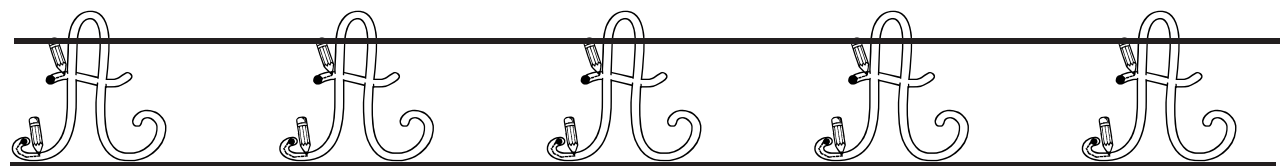
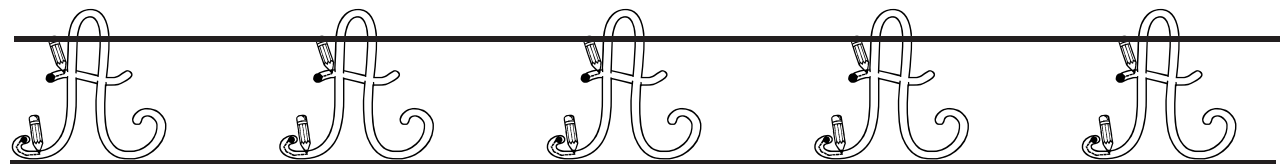
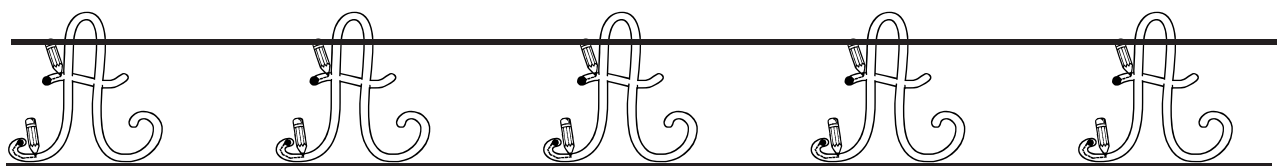
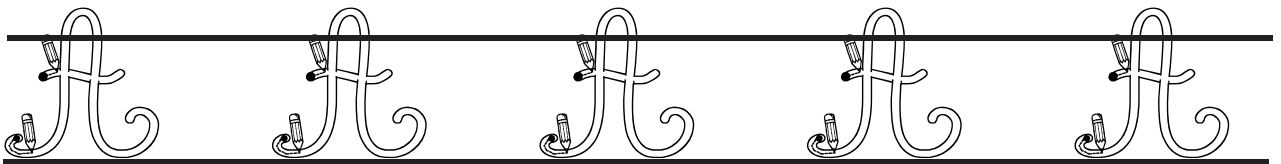
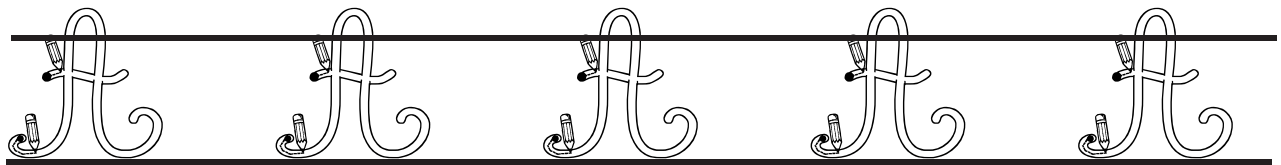
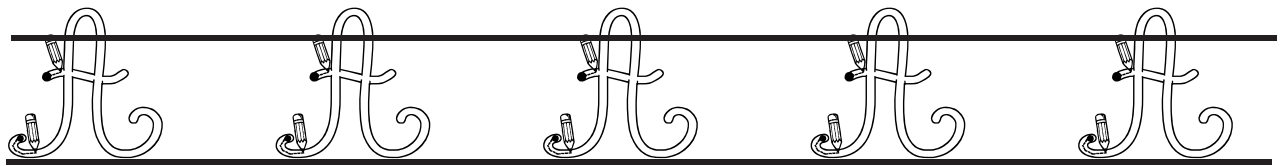
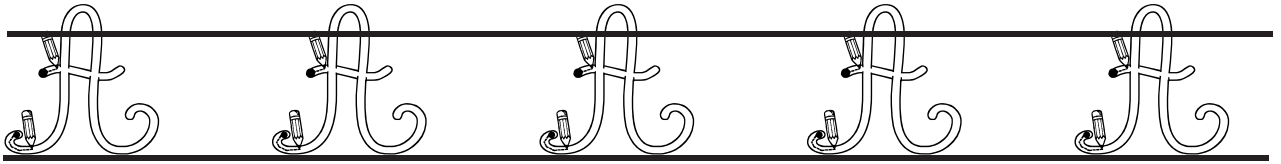

Nom _____ Date _____

Ecris la lettre A / a

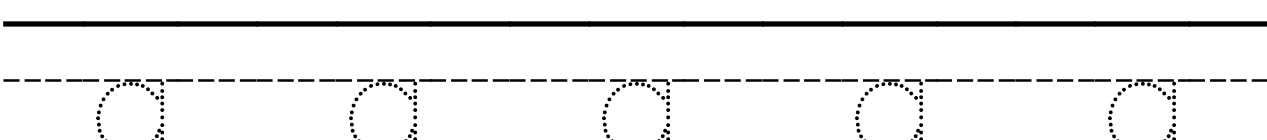
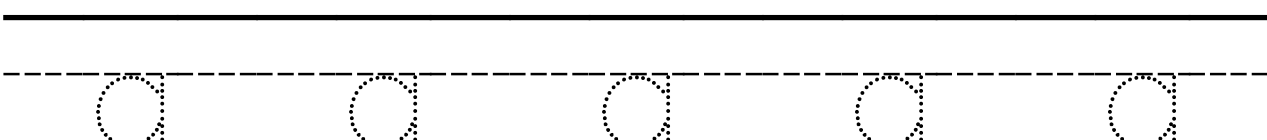
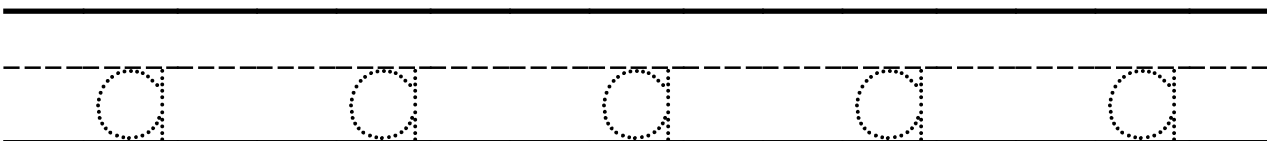
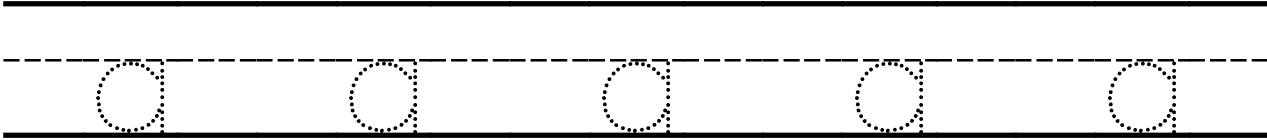
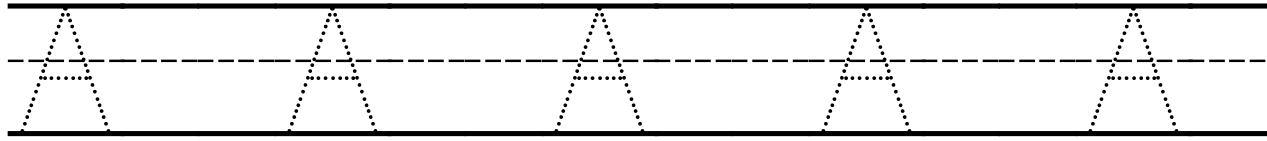
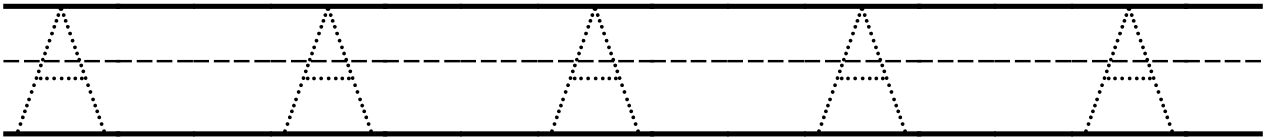
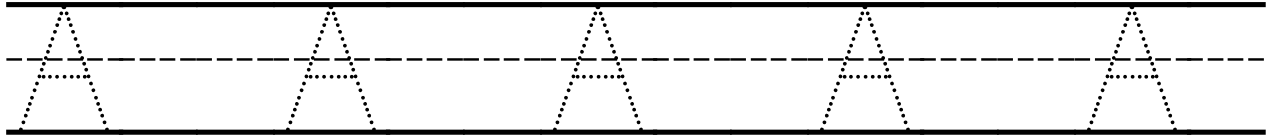
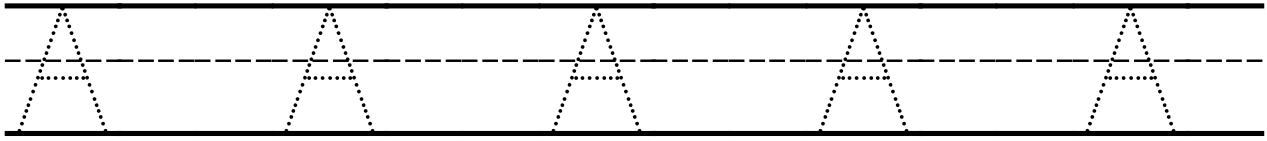

Nom _____ Date _____

Ecris la lettre A/a

A A A A A

Handwriting practice lines for uppercase letter A. Each row consists of a solid top line, a dashed middle line, and a solid bottom line. There are two such rows provided for practice.

a a a a a

Handwriting practice lines for lowercase letter a. Each row consists of a solid top line, a dashed middle line, and a solid bottom line. There are two such rows provided for practice.

Nom _____

Date _____

Colorie la lettre A

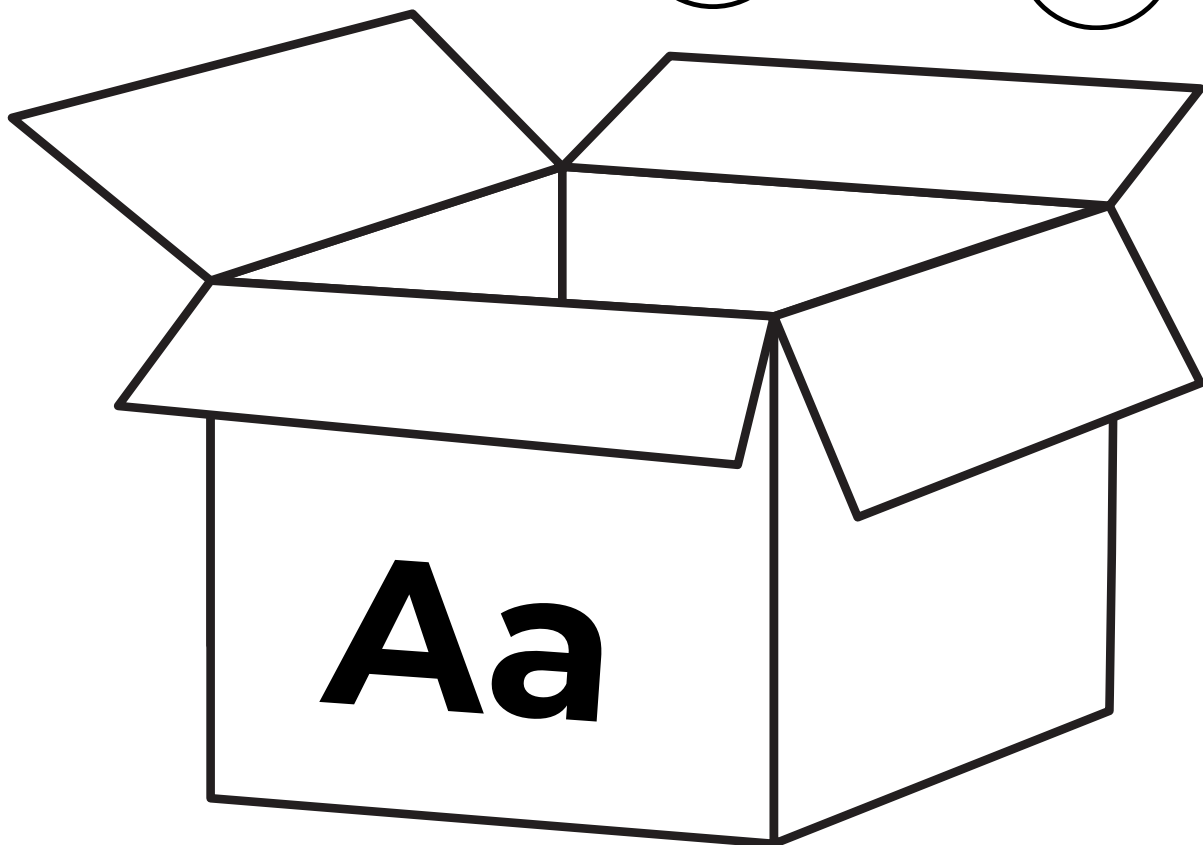
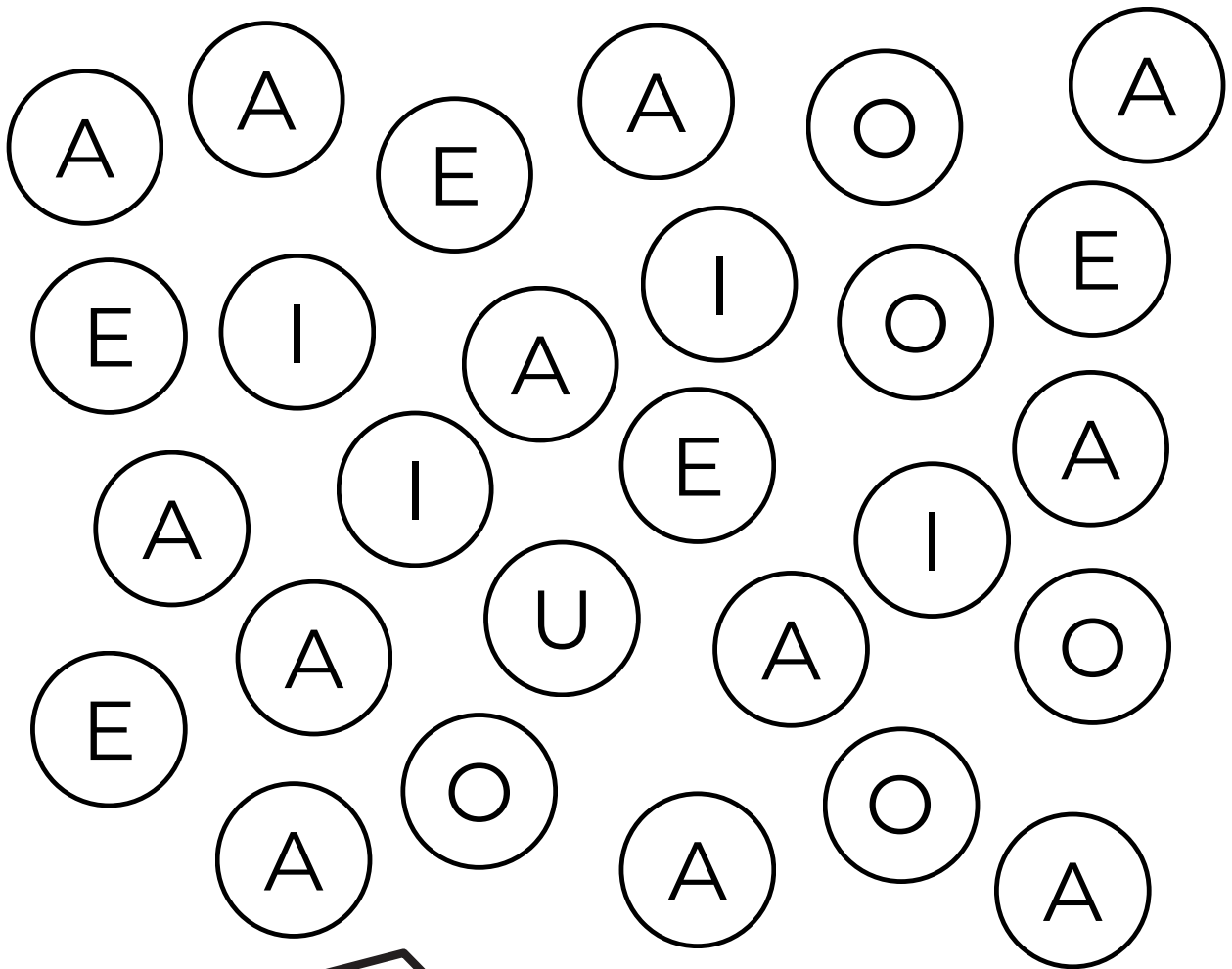

Nom _____

Date _____

Colorie la lettre a

o a e i a
e e a e a u
o u o o i a
o o a i a
o r a u
i a
a o
o i



ARAIGNEE / araignée

Nom _____

Date _____

Repasse sur la lettre B / b

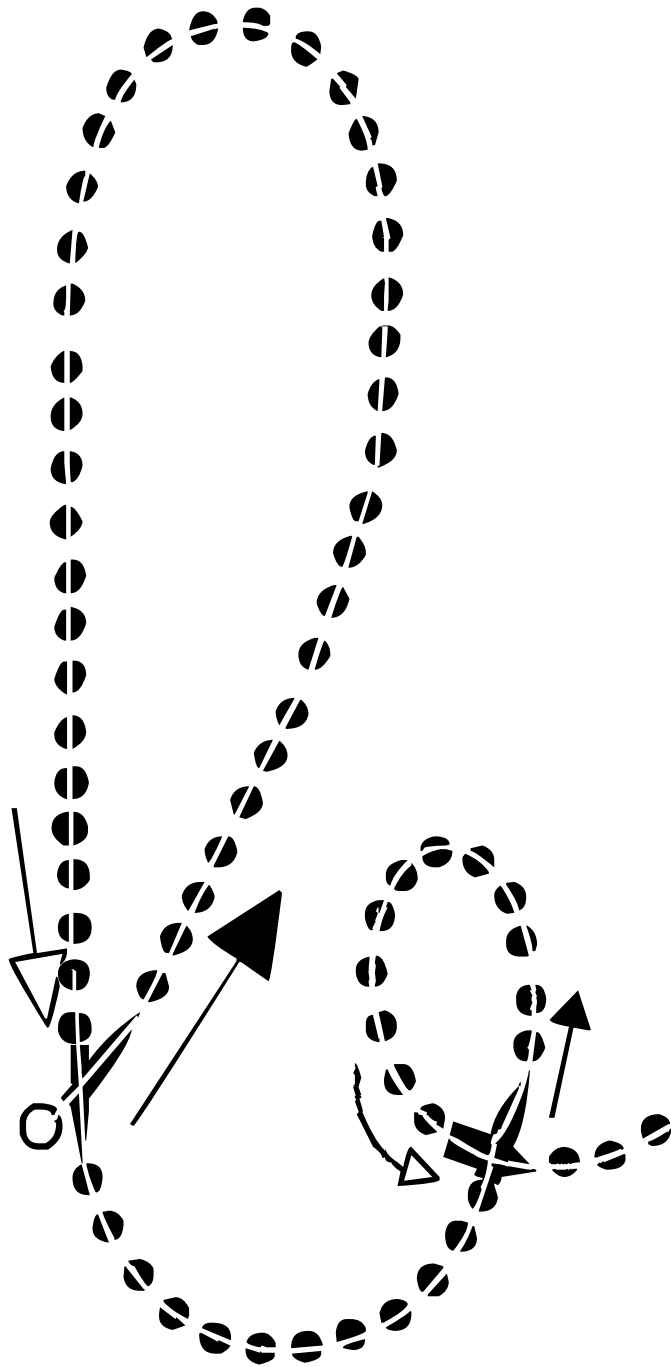

Nom _____

Date _____

Repasse sur la lettre B / b

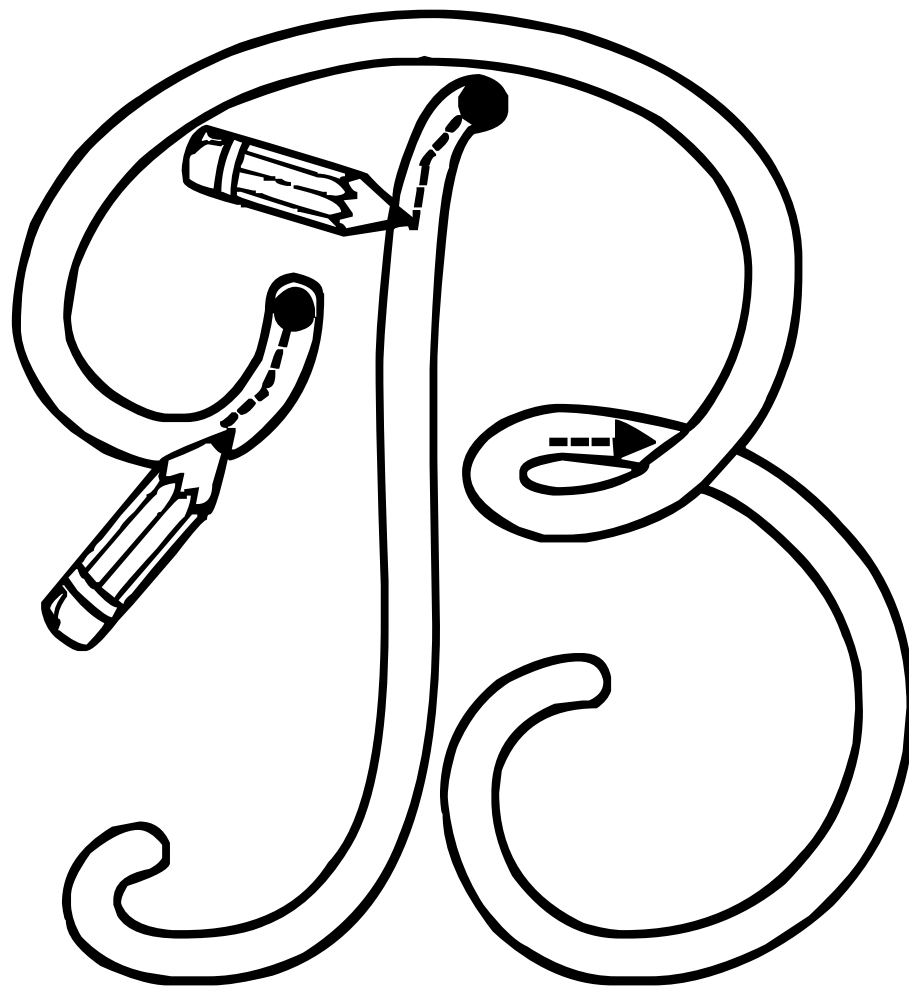

Nom _____

Date _____

Repasse sur la lettre B / b

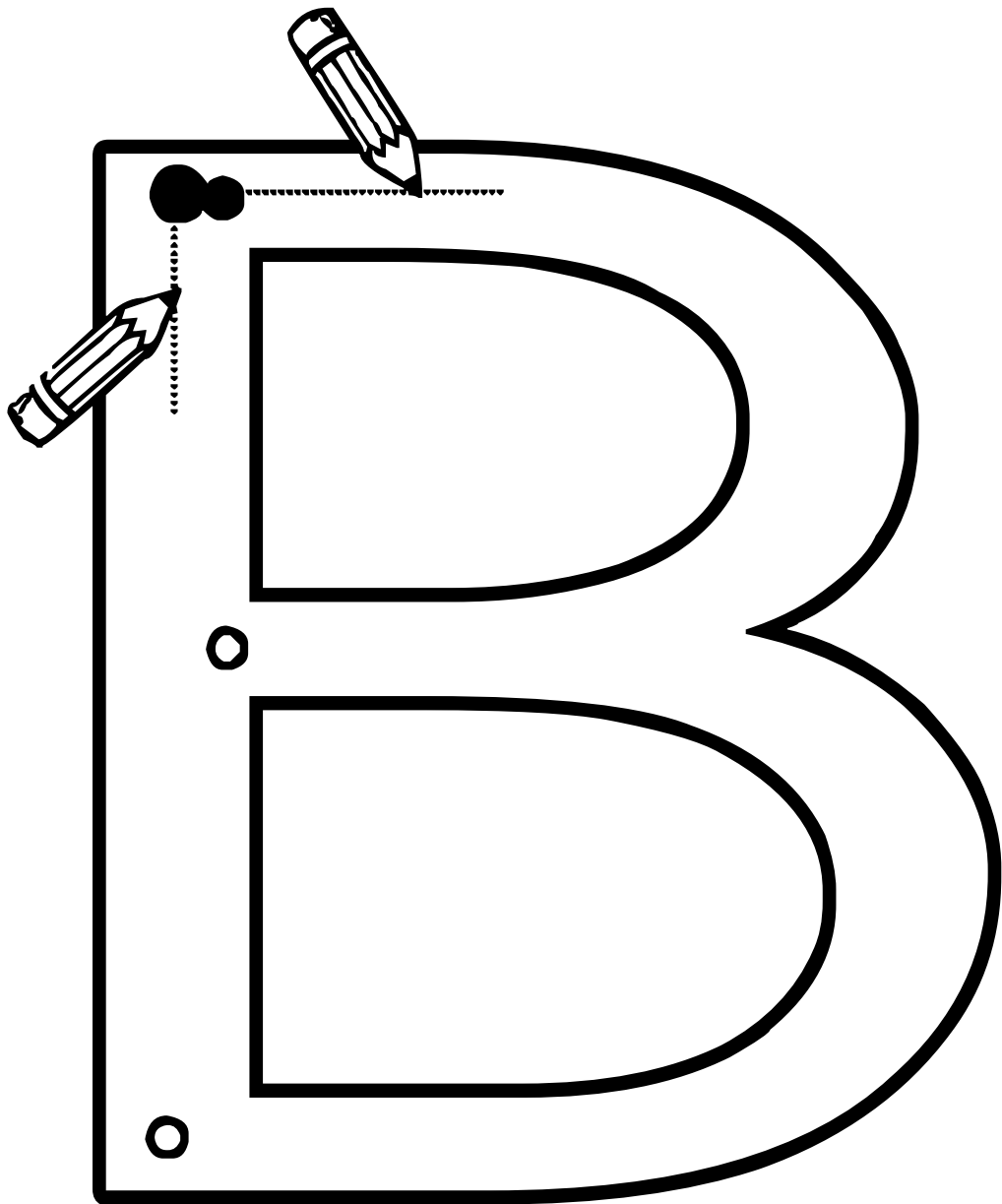

Nom _____

Date _____

Ecris la lettre B / b

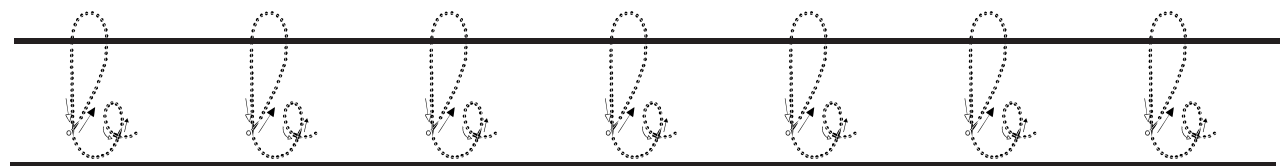
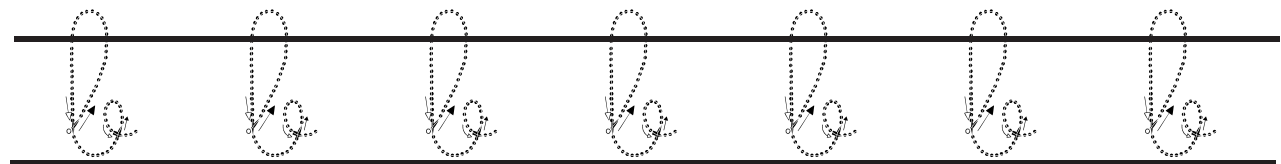
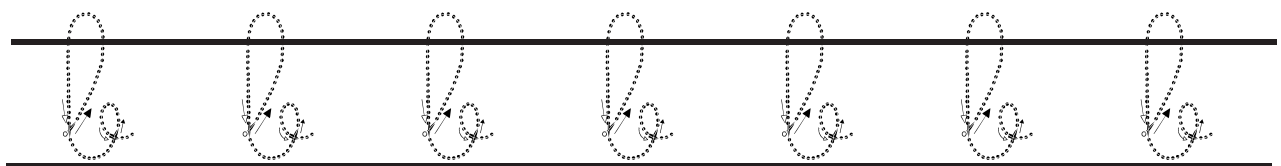
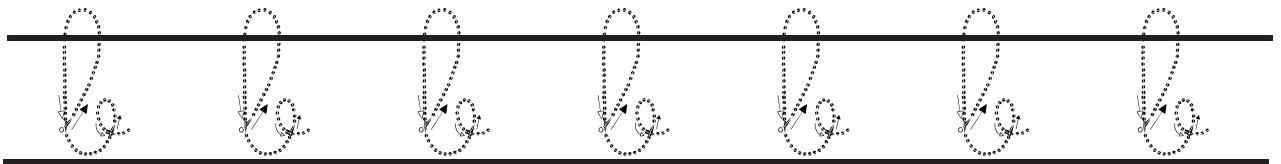
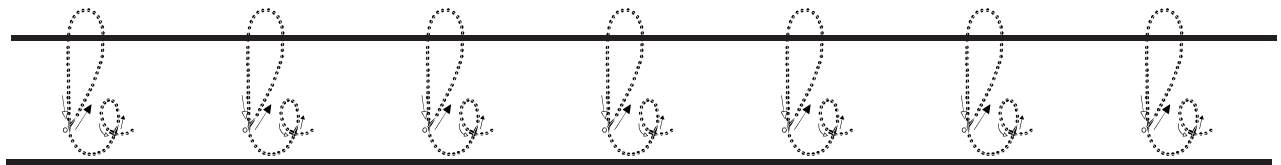
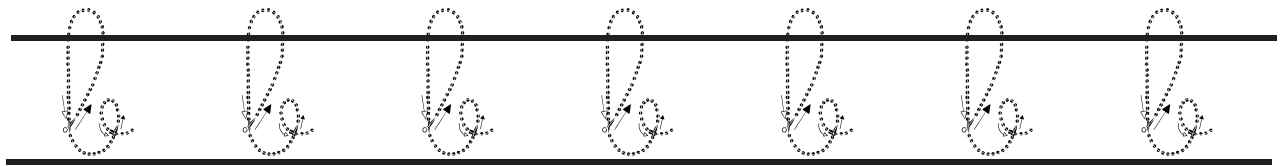
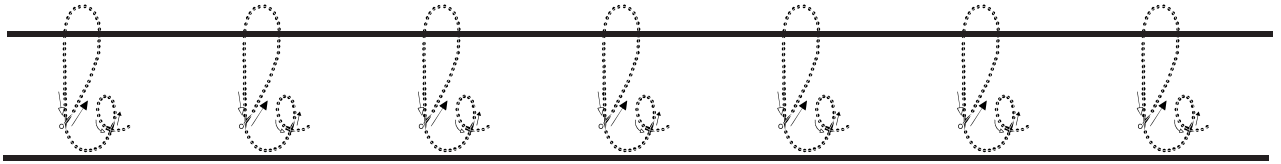

Nom _____

Date _____

Ecris la lettre B / b

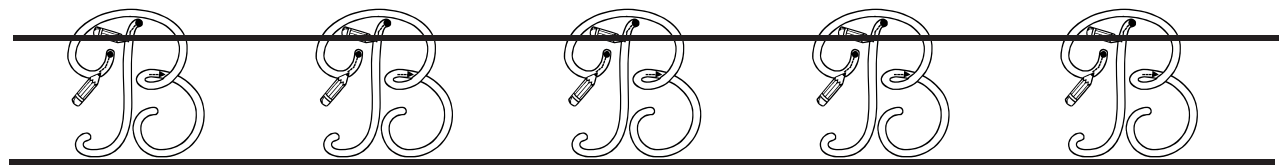
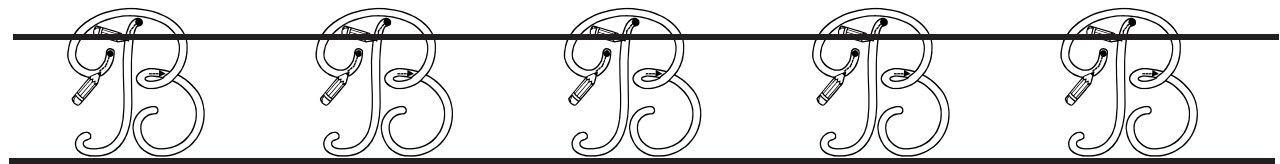
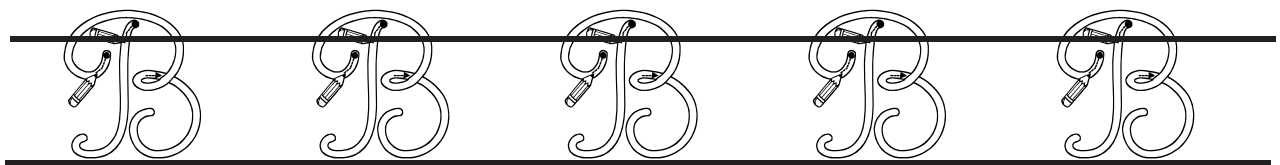
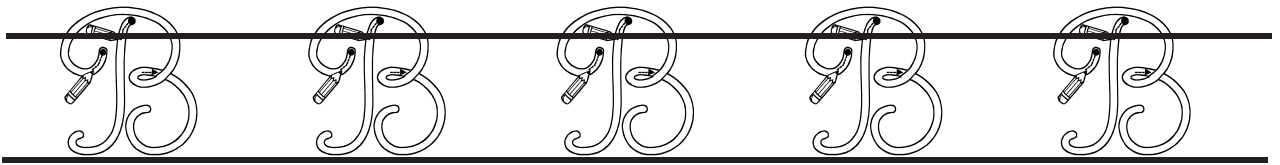
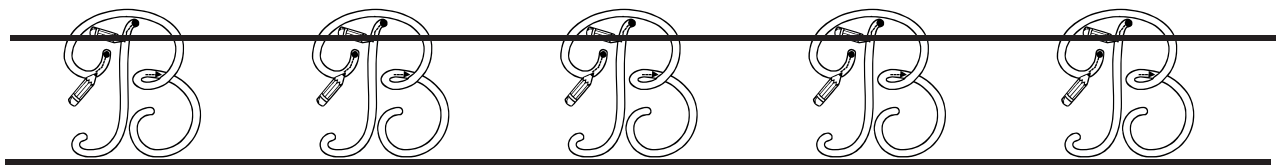
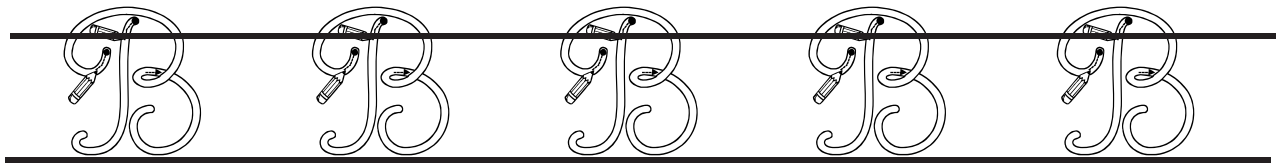
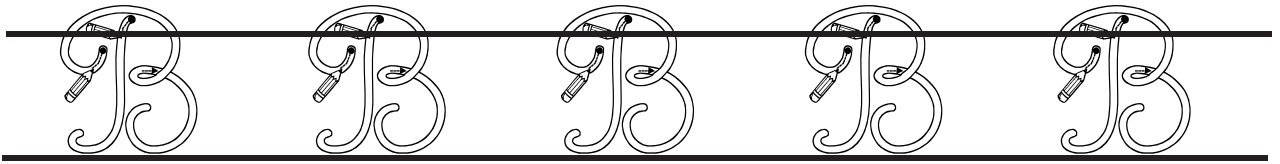

Nom _____

Date _____

Ecris la lettre B/b

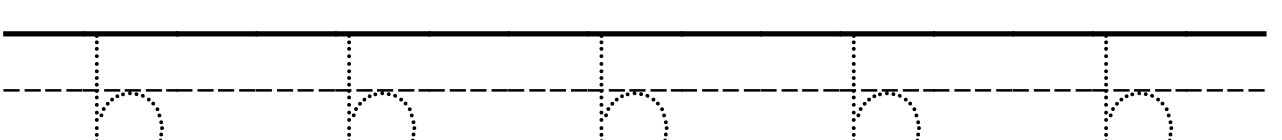
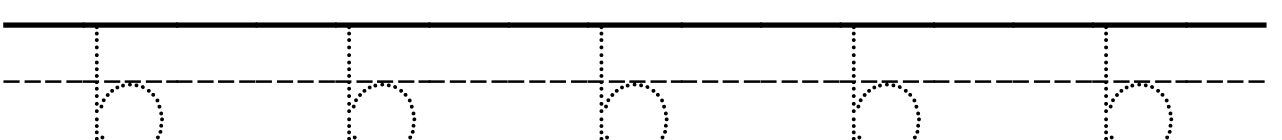
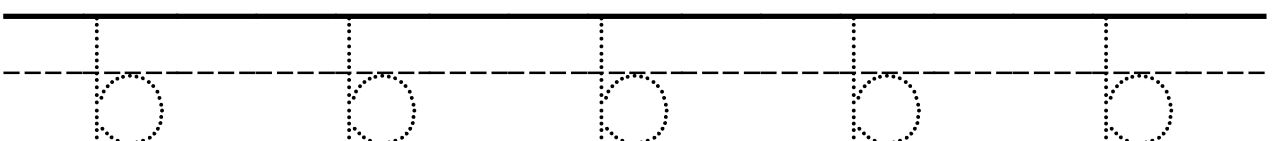
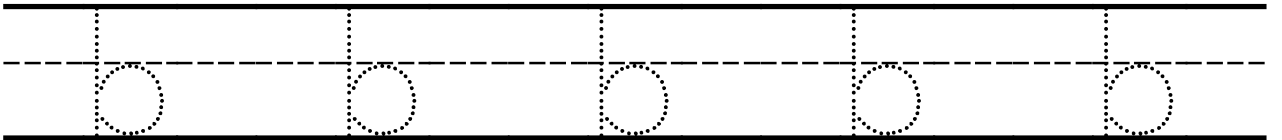
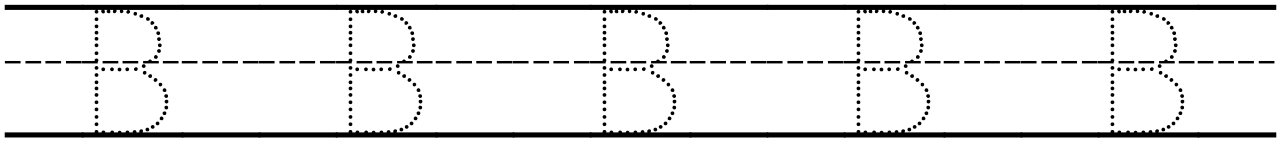
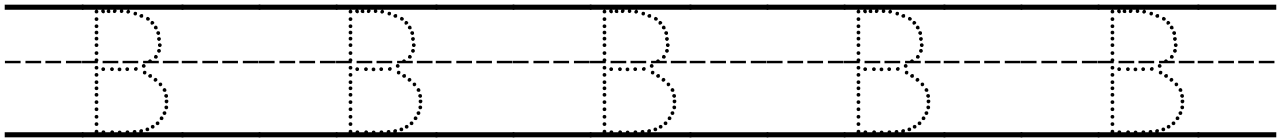
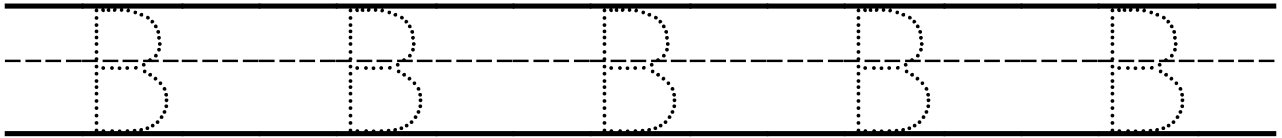
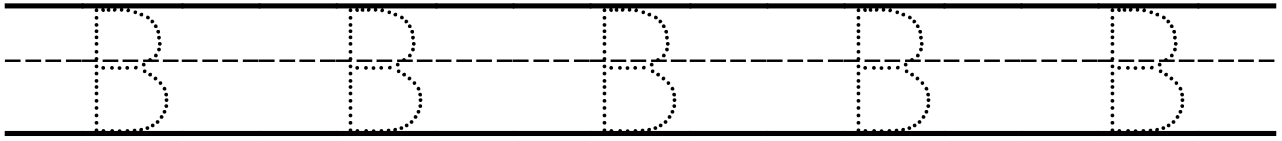

Nom _____ Date _____

Ecris la lettre B/b

B

B

B

B

B

Handwriting practice lines for uppercase letter B. The first set consists of a solid top line, a dashed middle line, and a solid bottom line. The second set consists of a solid top line, a dashed middle line, and a solid bottom line.

b

b

b

b

b

Handwriting practice lines for lowercase letter b. The first set consists of a solid top line, a dashed middle line, and a solid bottom line. The second set consists of a solid top line, a dashed middle line, and a solid bottom line.

Nom _____

Date _____

Colorie la lettre B

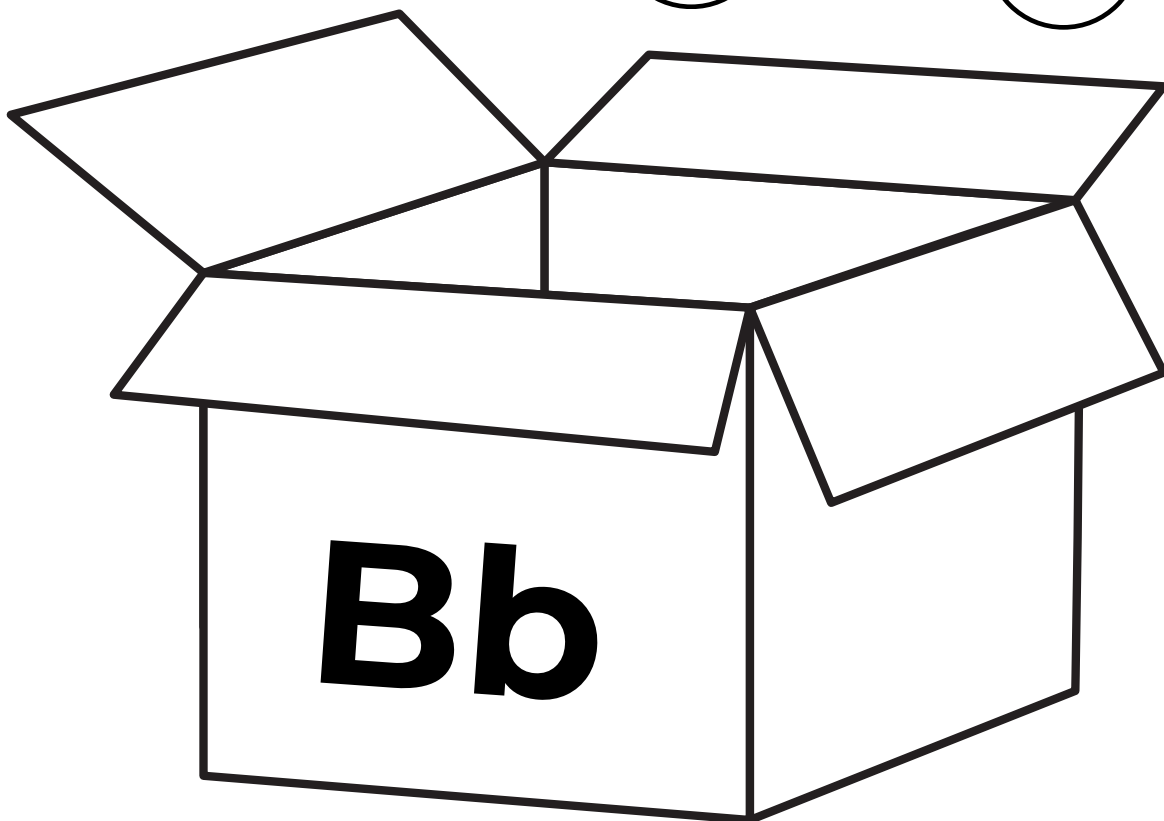
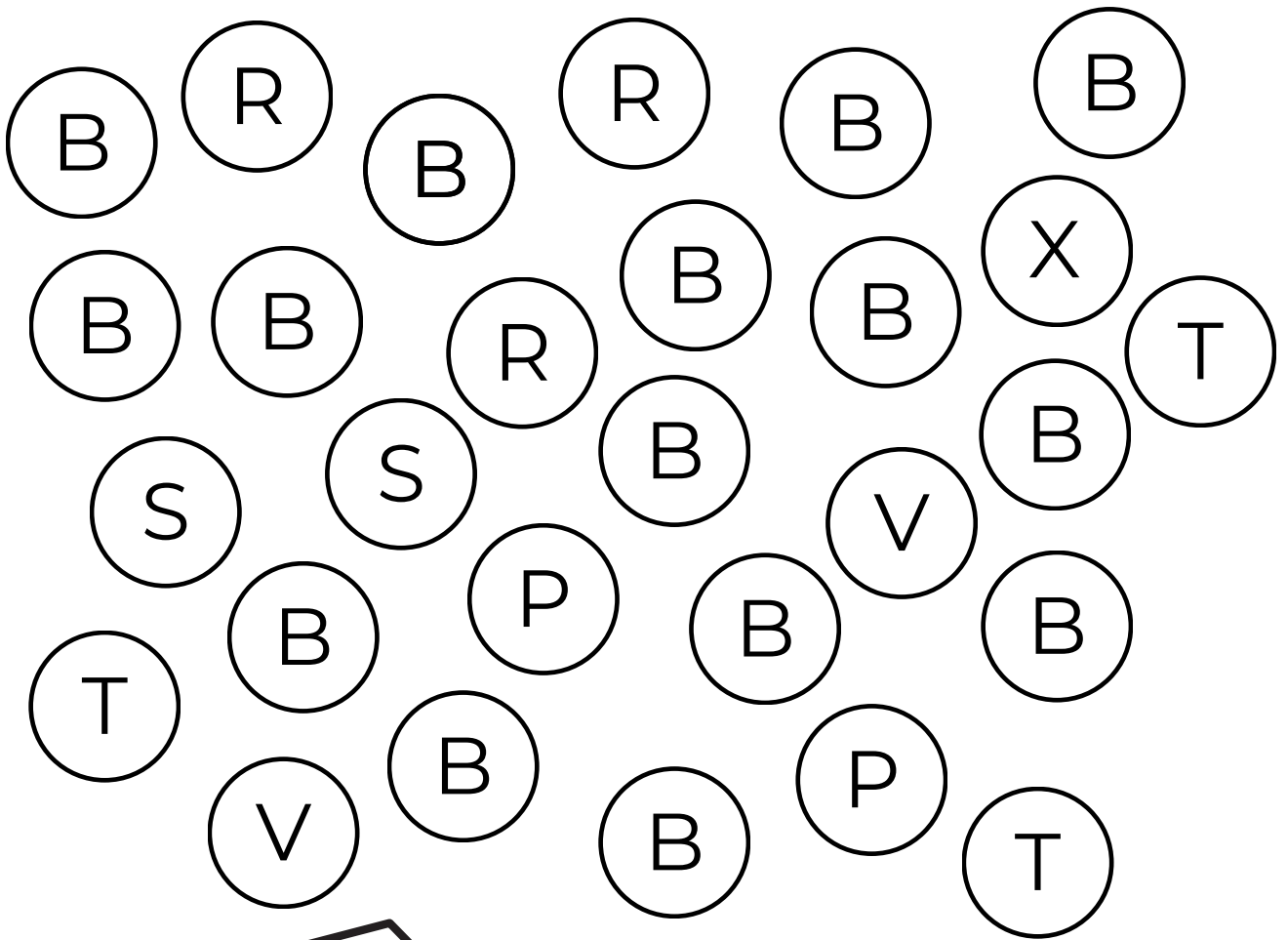

Nom _____

Date _____

Colorie la lettre b

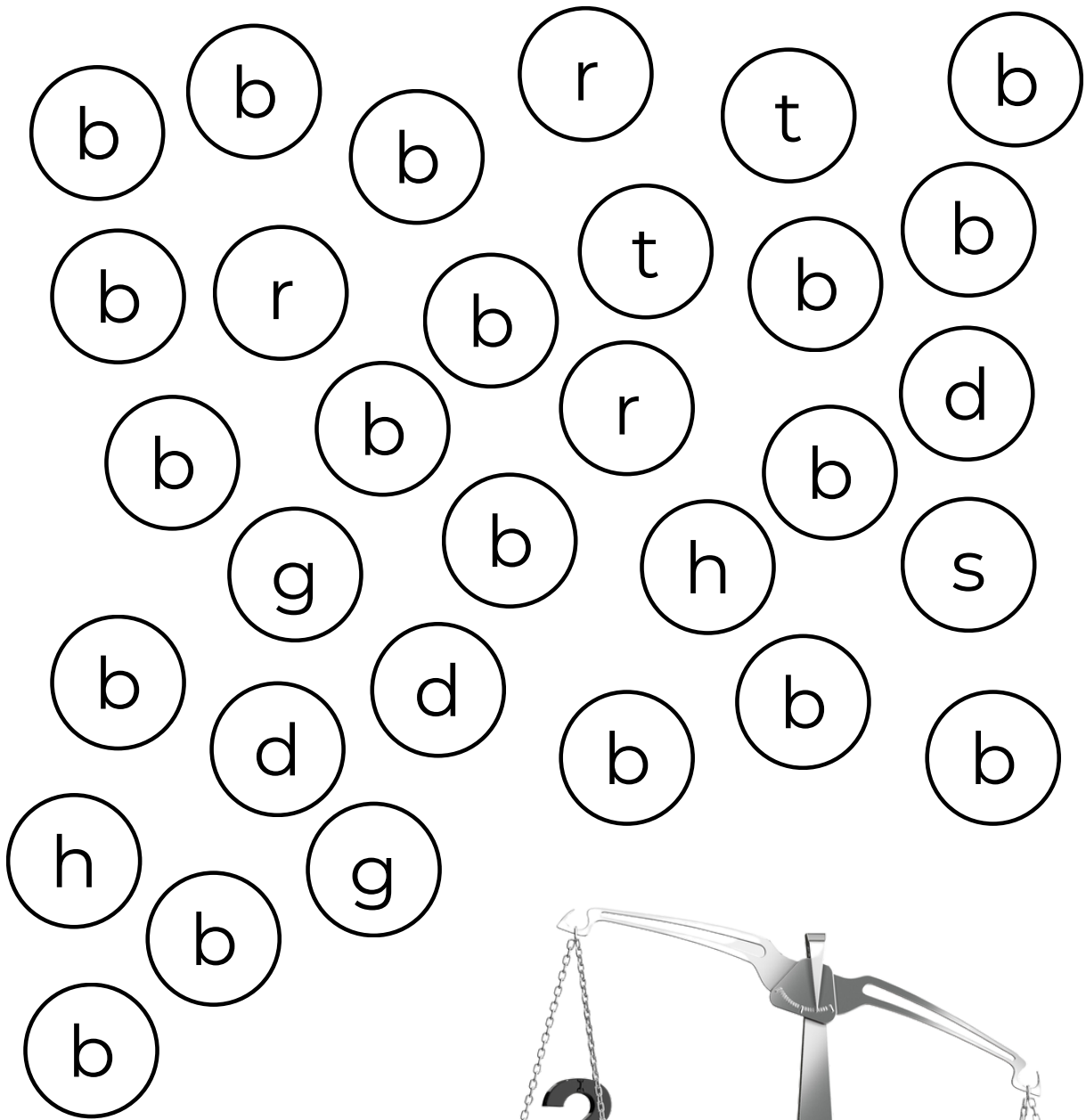

BALANCE / balance

Nom _____

Date _____

Repasse sur la lettre C / c

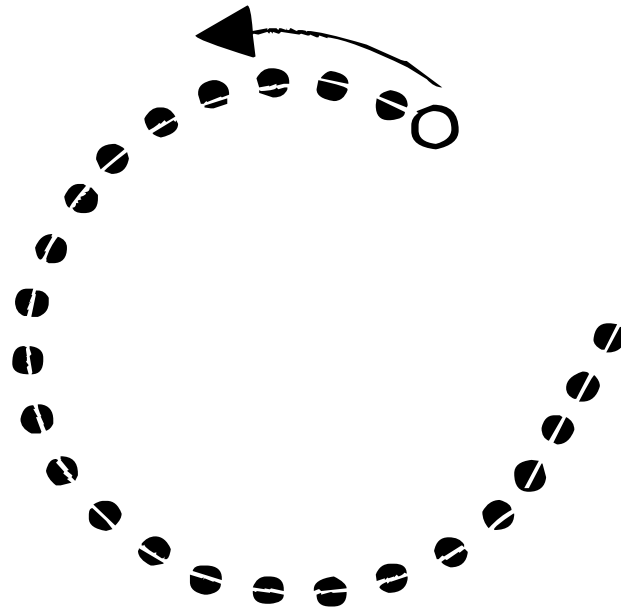

Nom _____

Date _____

Repasse sur la lettre C / c

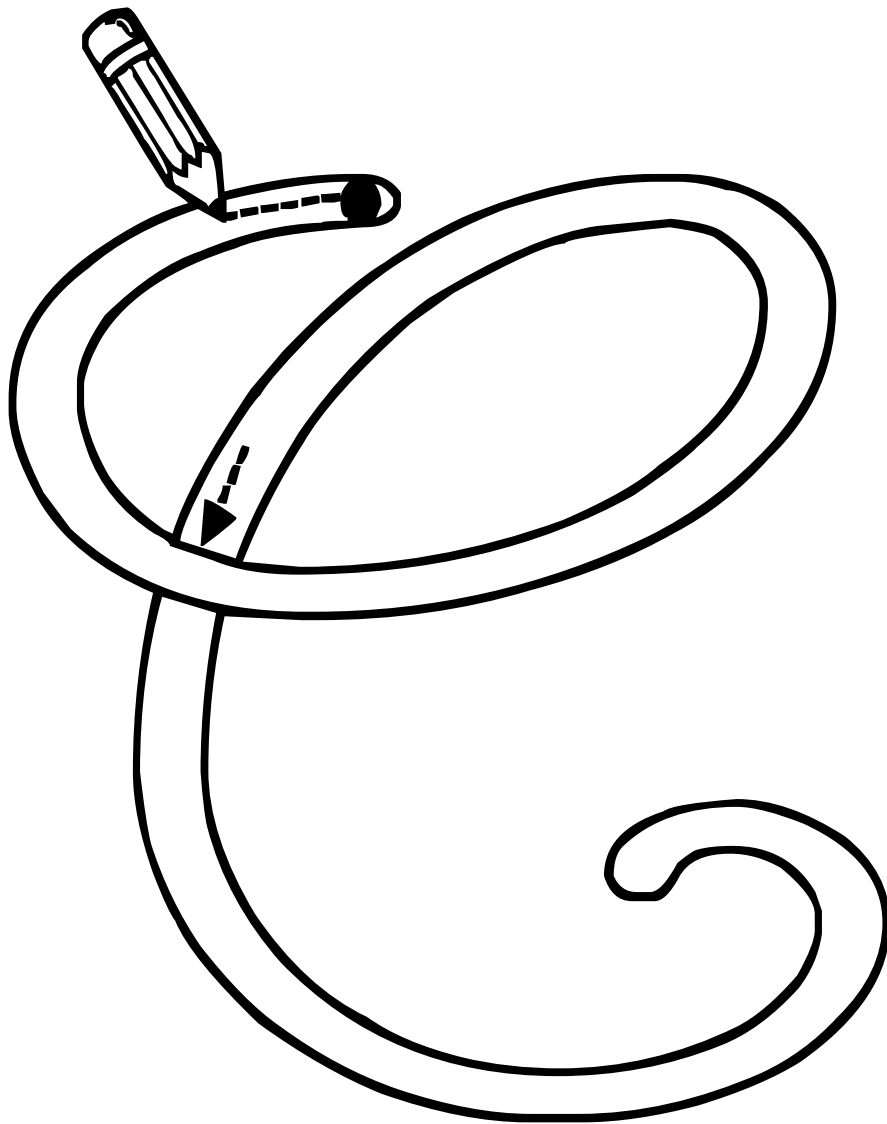

Nom _____

Date _____

Repasse sur la lettre C / c

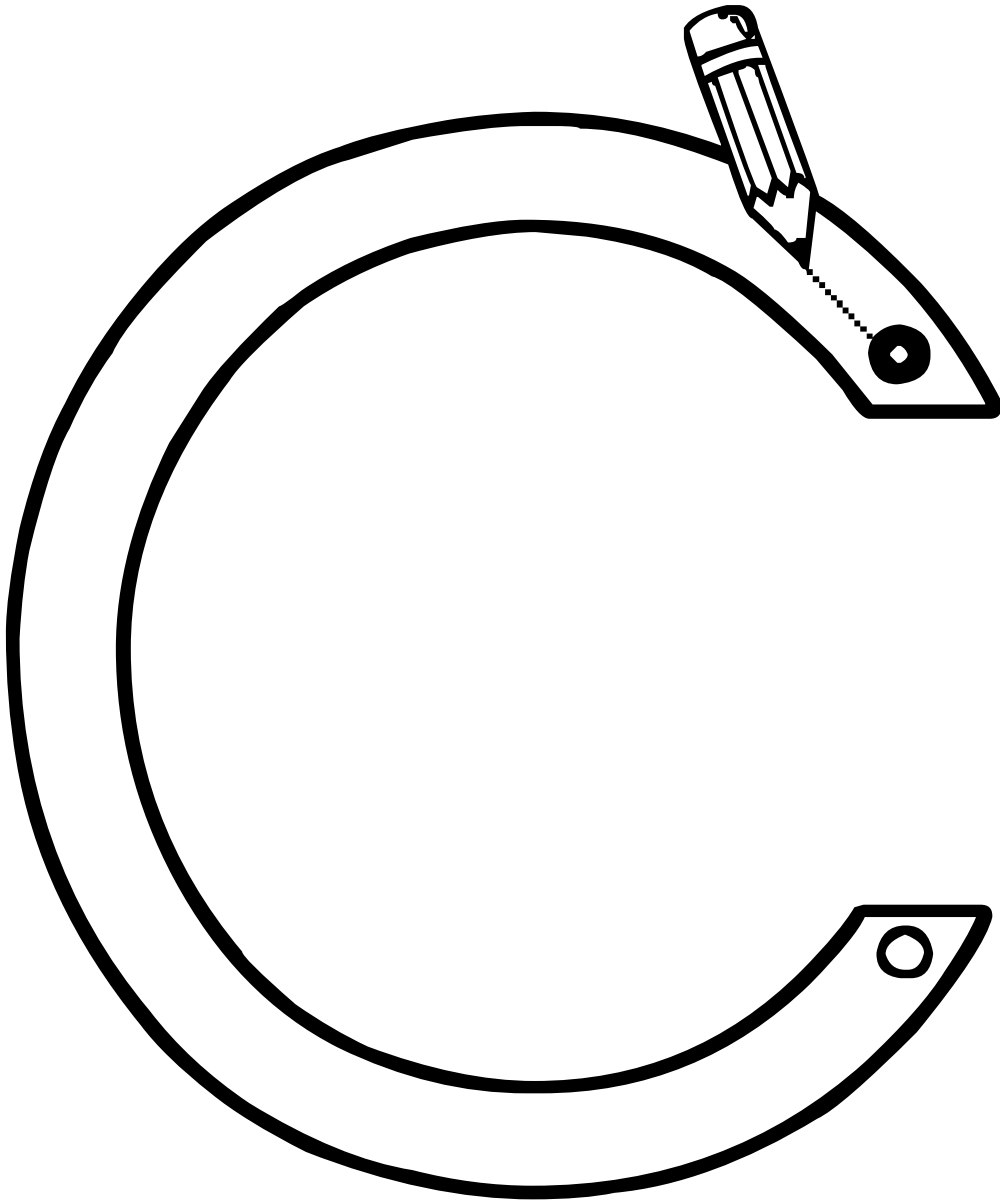

Nom _____ Date _____

Ecris la lettre C / c

C C C C C C C

C C C C C C C

C C C C C C C

C C C C C C C

C C C C C C C

C C C C C C C

C C C C C C C

Nom _____

Date _____

Ecris la lettre C / c

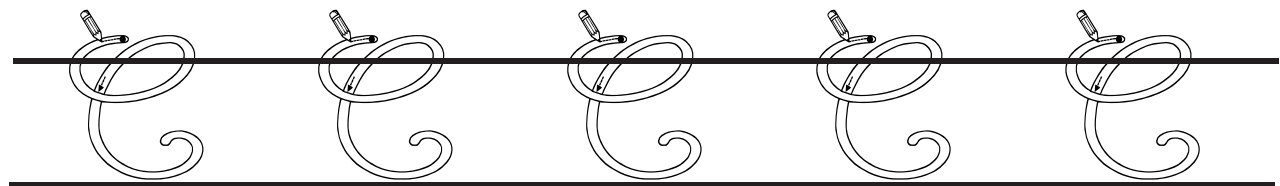
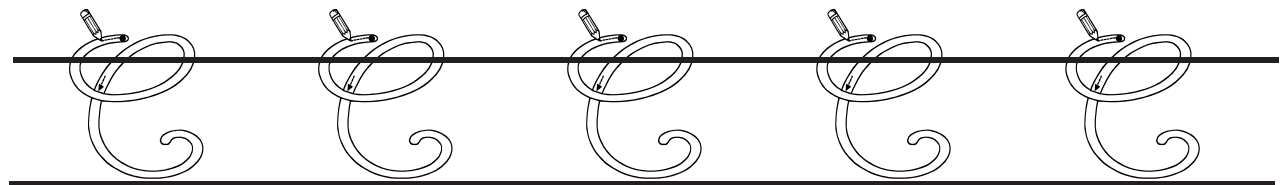
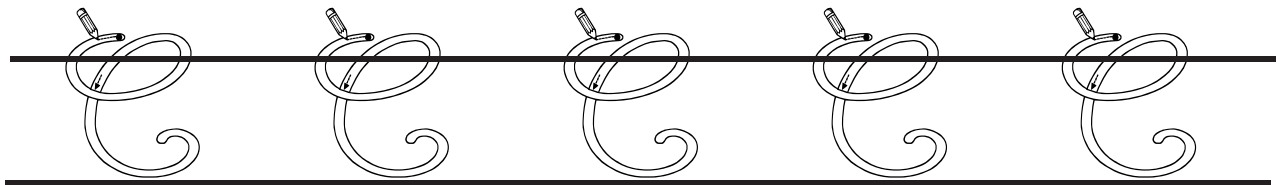
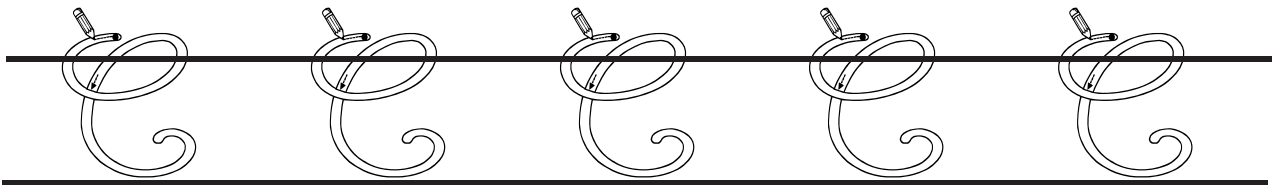
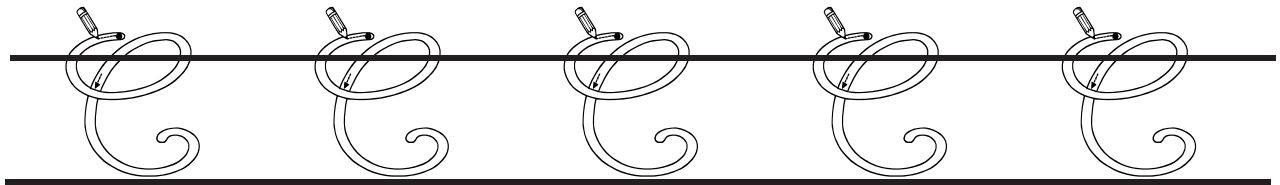
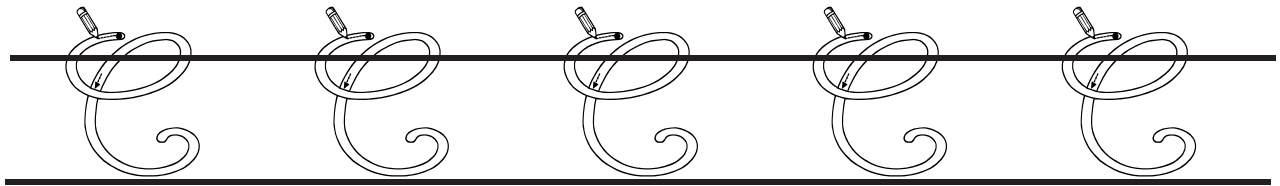
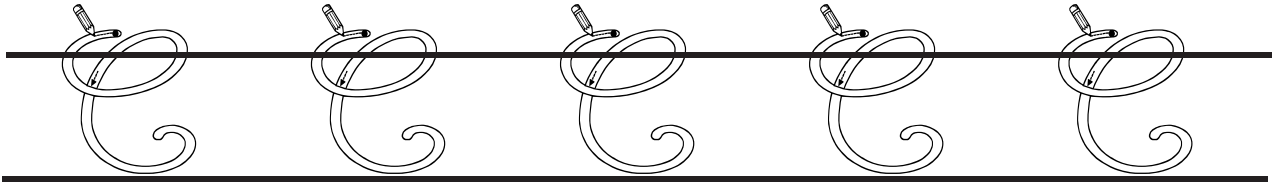

Nom _____ Date _____

Ecris la lettre C/c

C C C C C

C C C C C

C C C C C

C C C C C

c c c c c

c c c c c

c c c c c

c c c c c

Nom _____ Date _____

Ecris la lettre C/c

C C C C C

Handwriting practice lines for uppercase 'C'. Each set consists of a solid top line, a dashed middle line, and a solid bottom line. There are two such sets of lines provided for practice.

c c c c c

Handwriting practice lines for lowercase 'c'. Each set consists of a solid top line, a dashed middle line, and a solid bottom line. There are two such sets of lines provided for practice.

Nom _____

Date _____

Colorie la lettre C

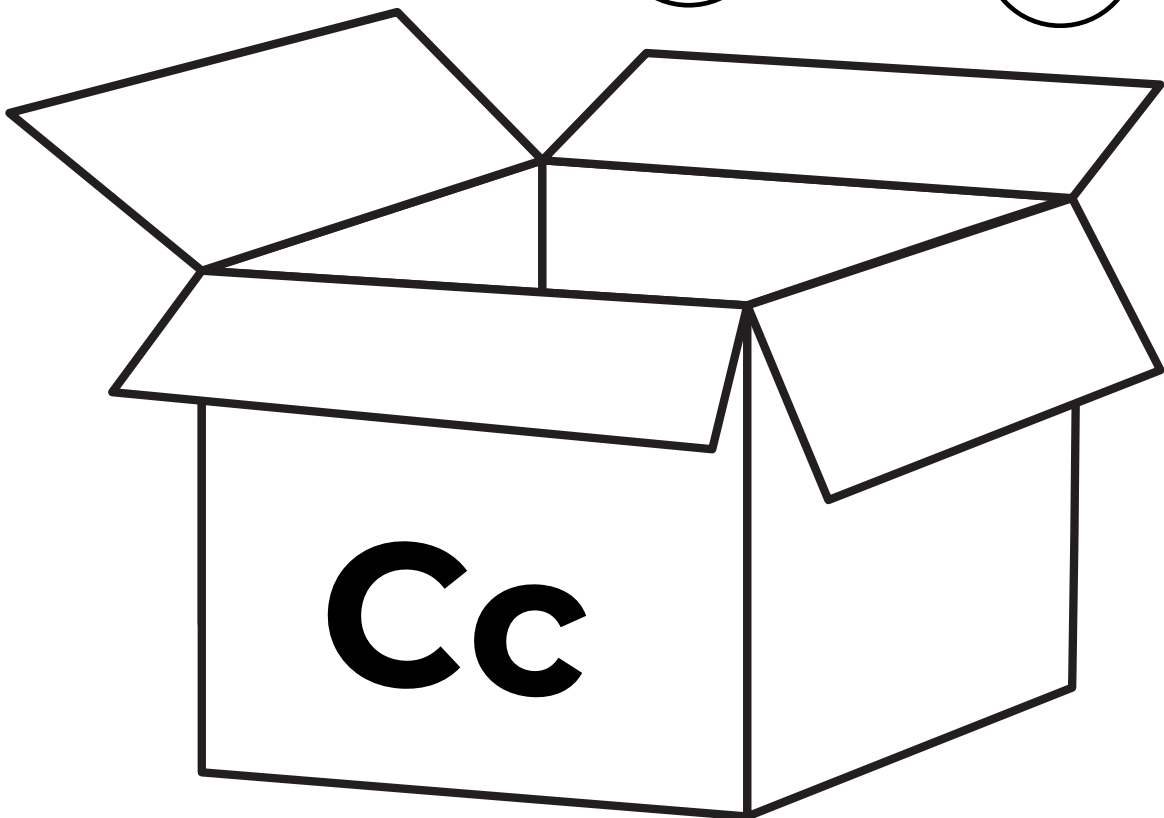
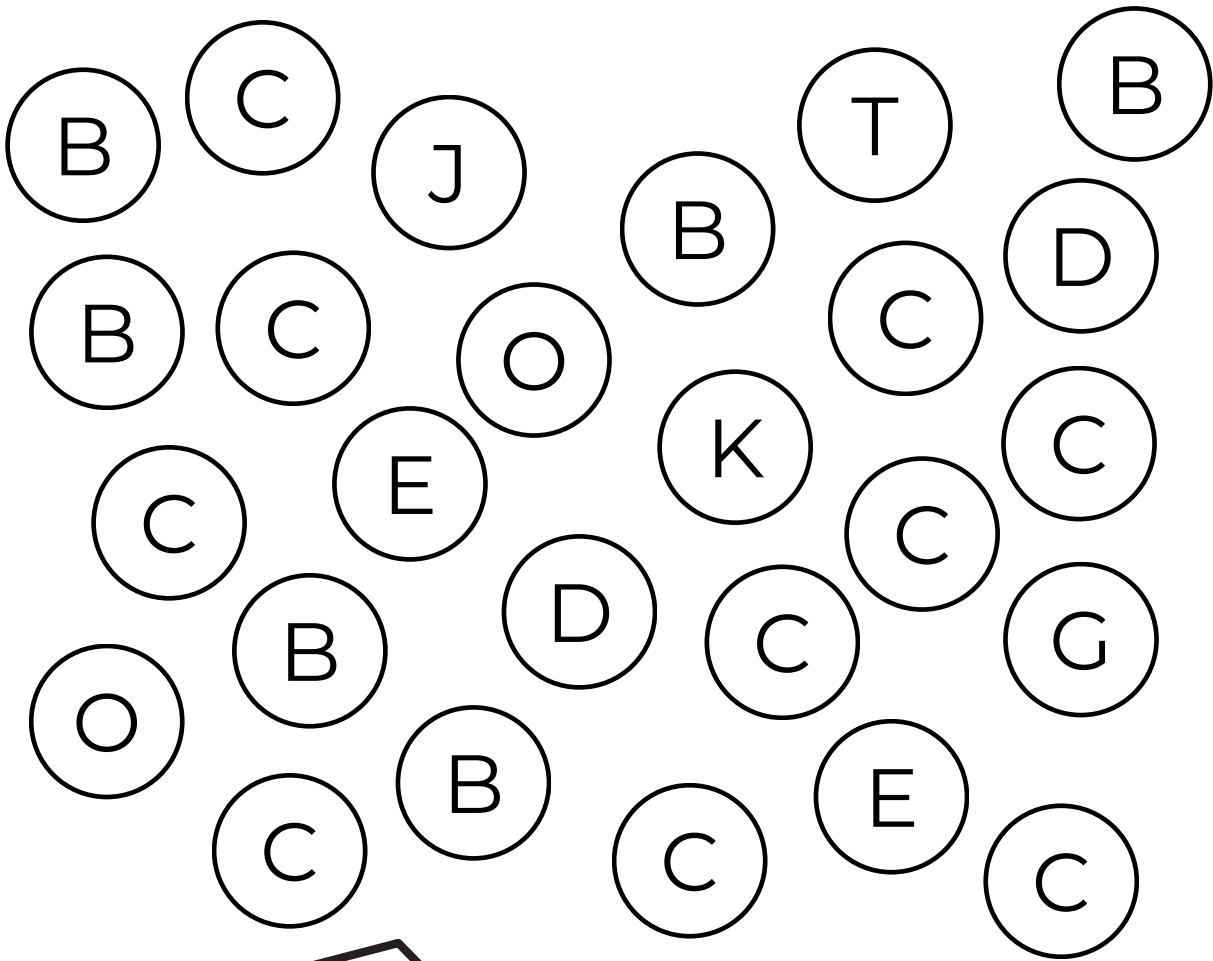

Nom _____

Date _____

Colorie la lettre c

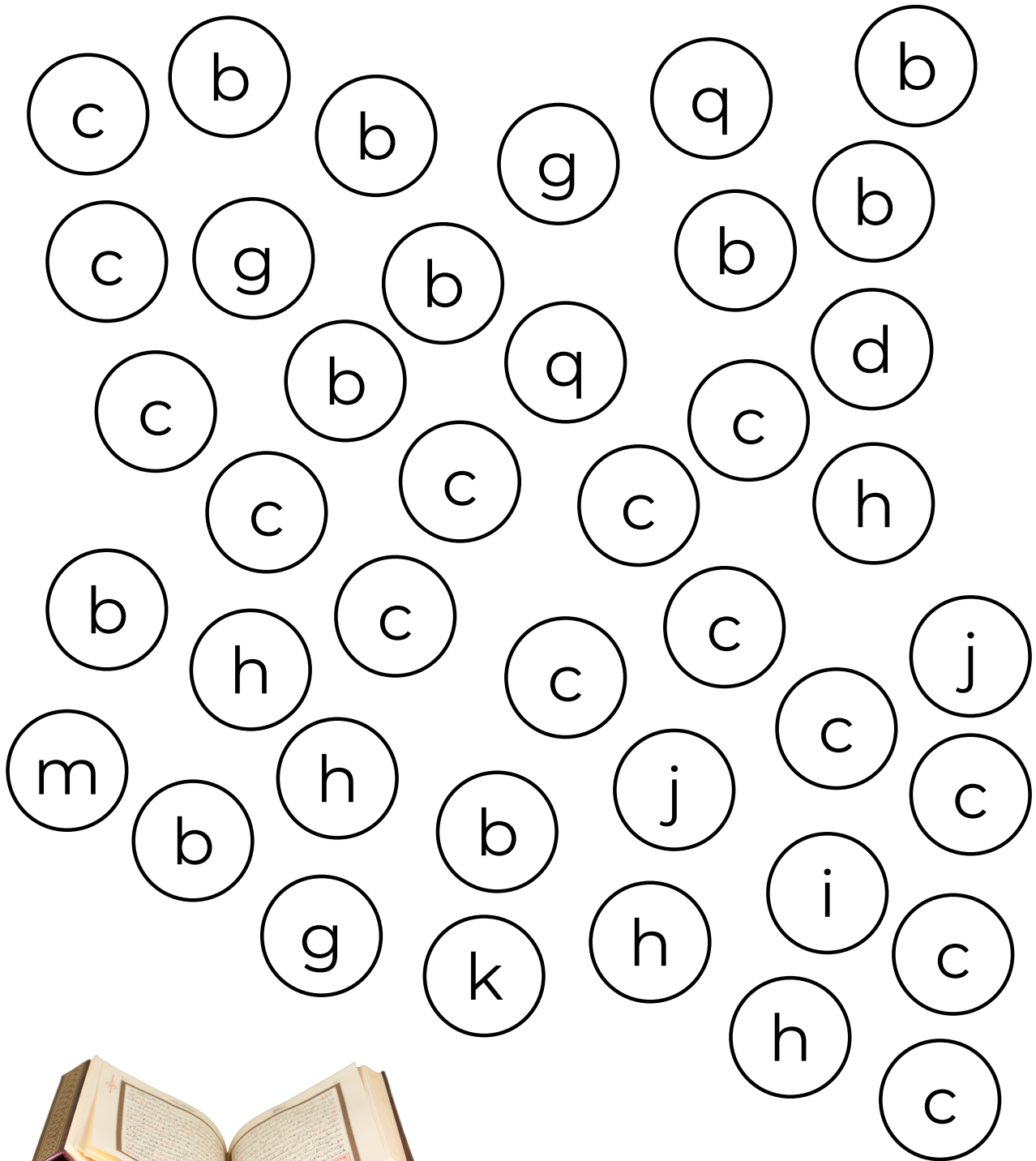

CORAN / coran

Nom _____

Date _____

Repasse sur la lettre D / d

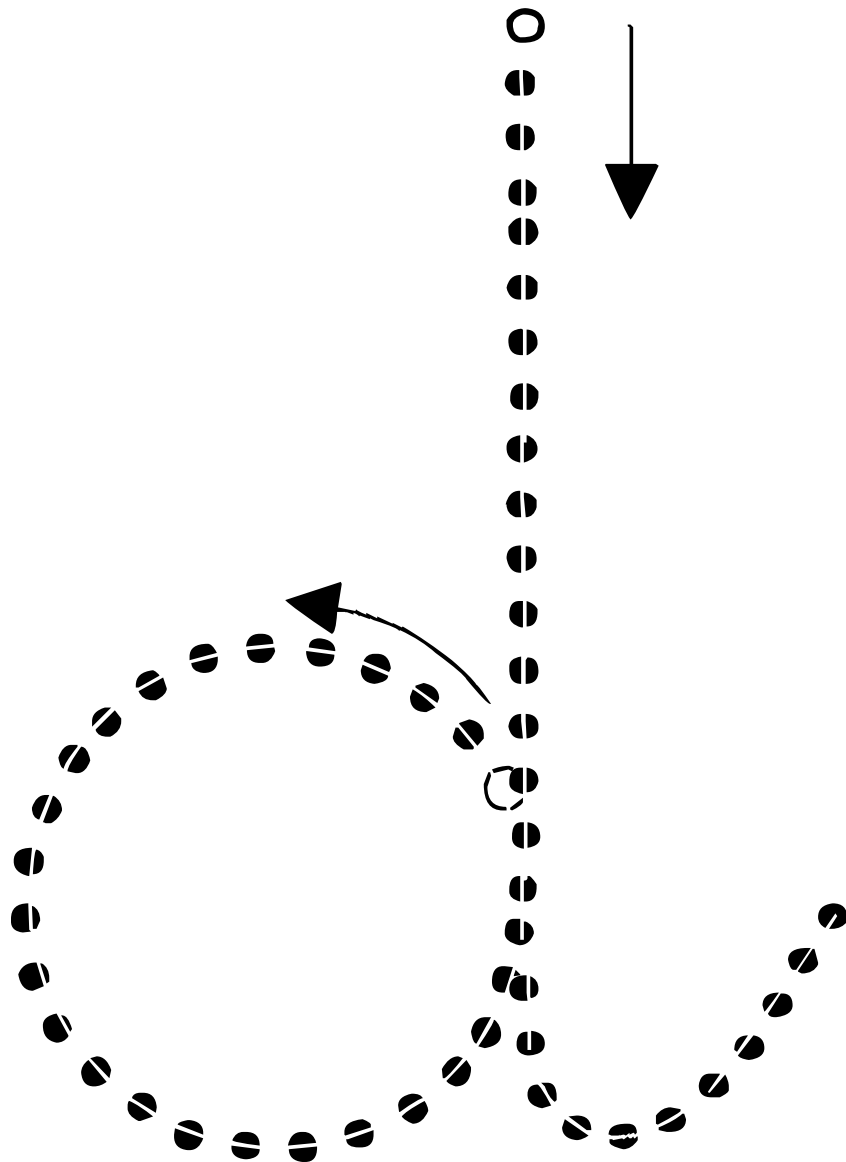

Nom _____

Date _____

Repasse sur la lettre D / d

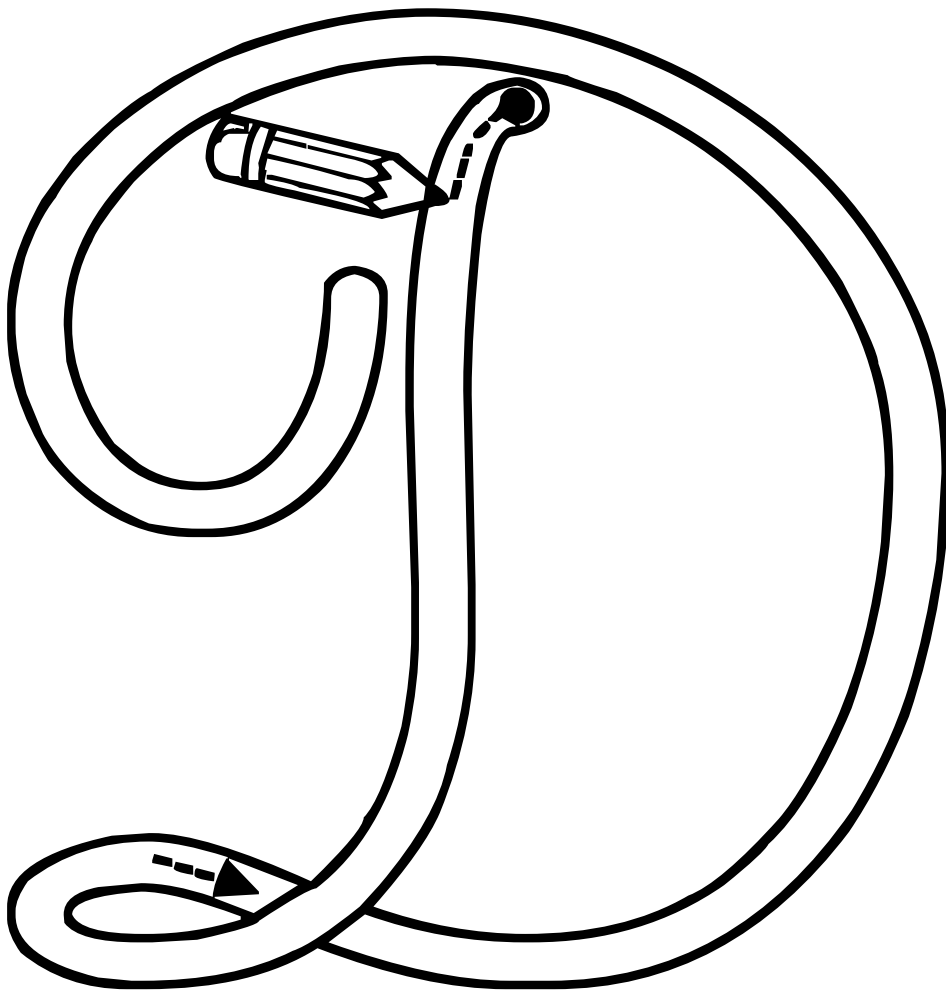

Nom _____

Date _____

Repasse sur la lettre D / d

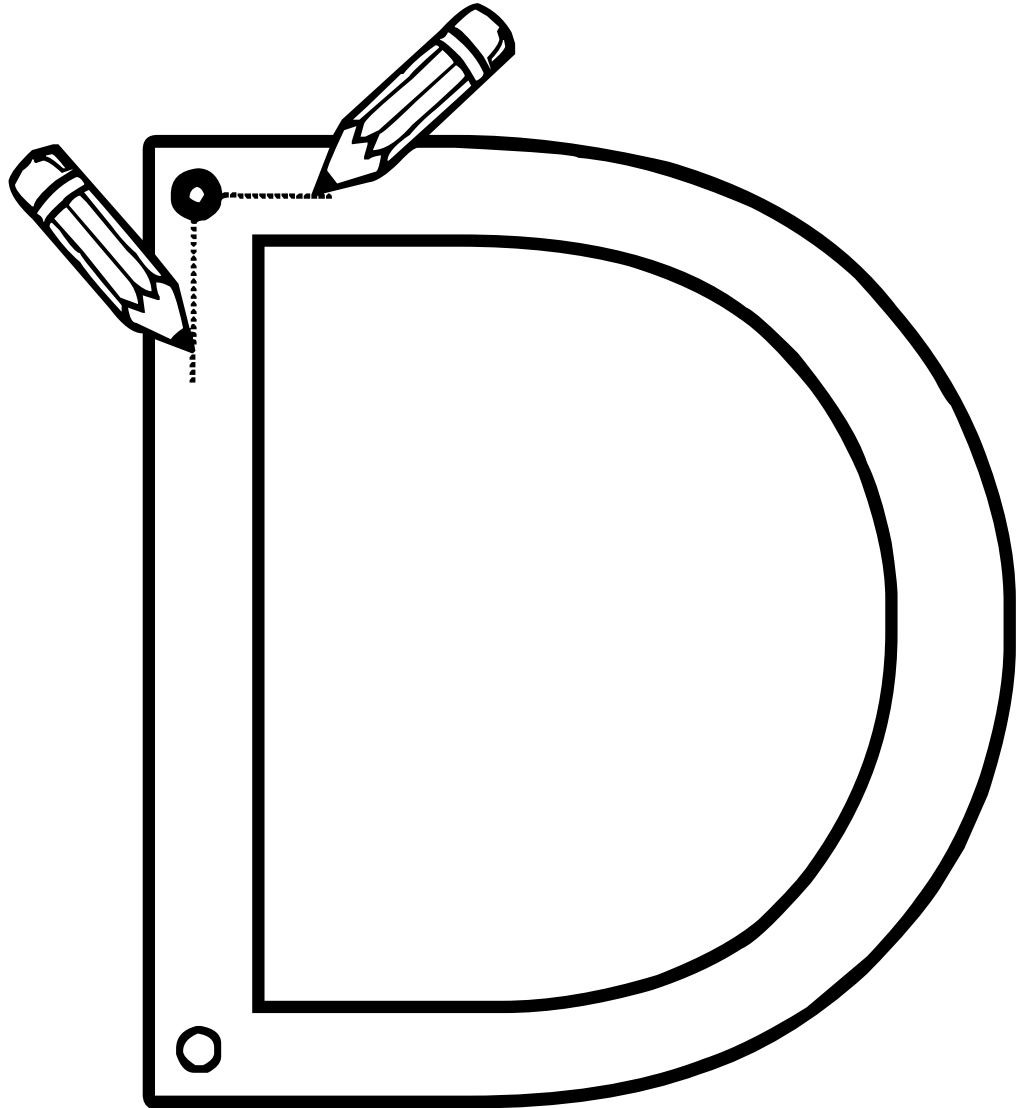

Nom _____

Date _____

Ecris la lettre D / d

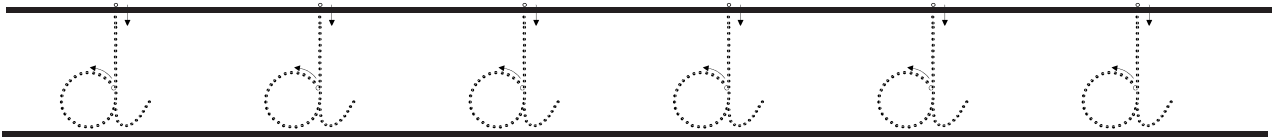

Nom _____

Date _____

Ecris la lettre D / d

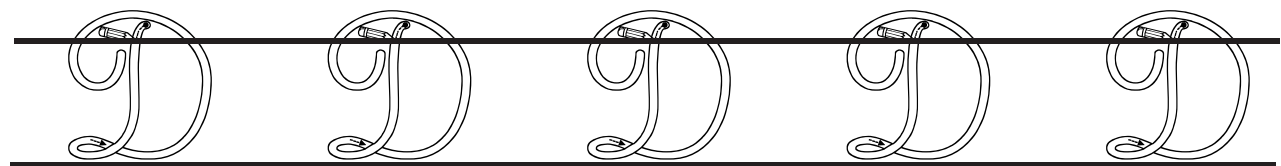
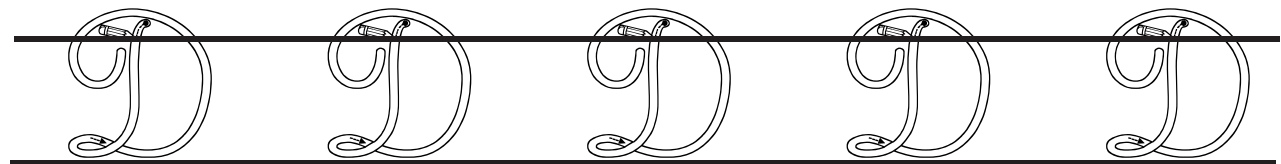
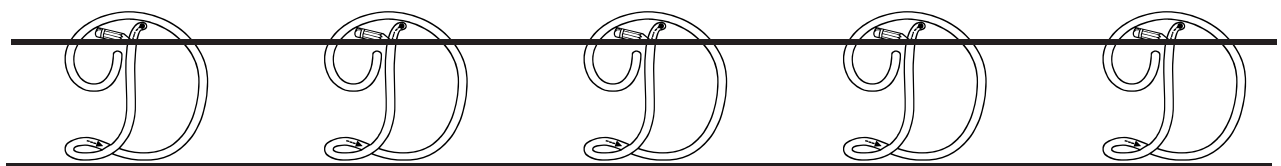
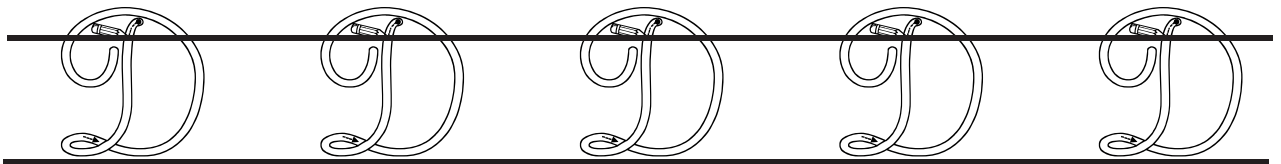
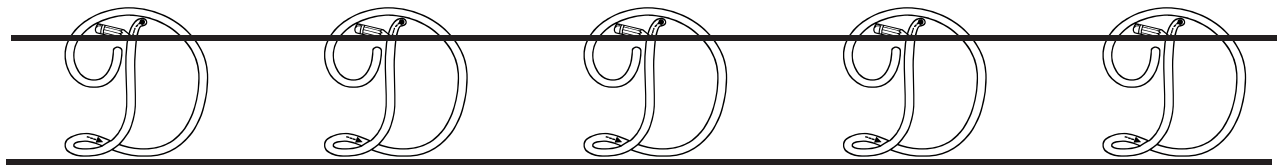
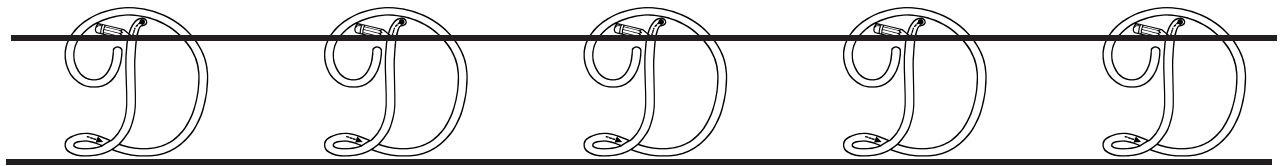
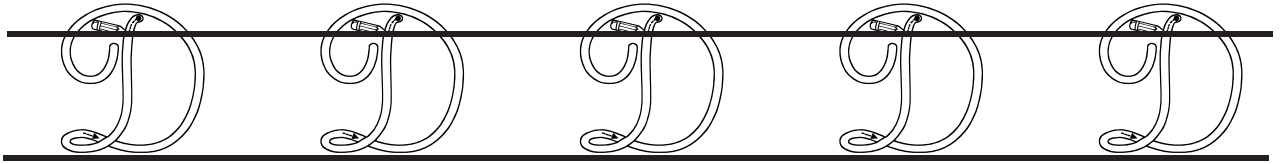

Nom _____ Date _____

Ecris la lettre D/d

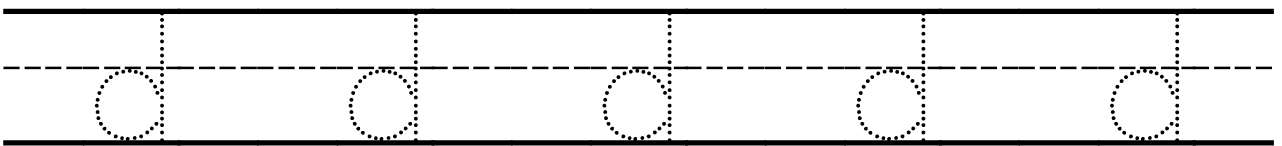
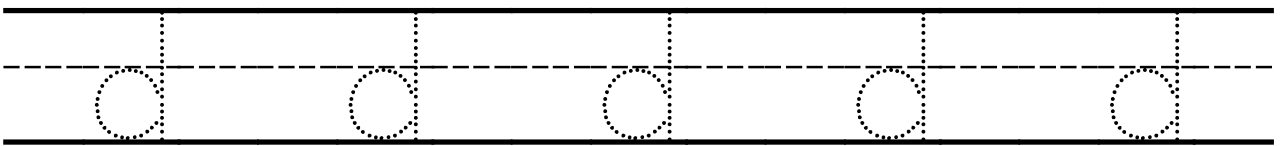
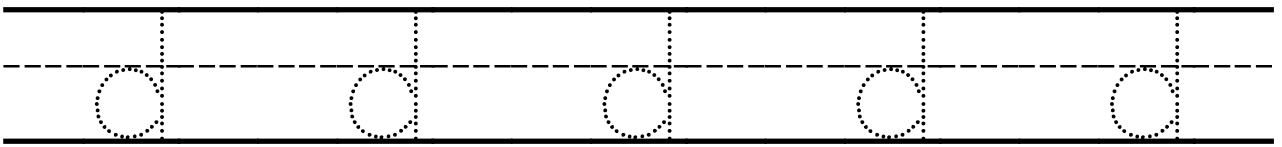
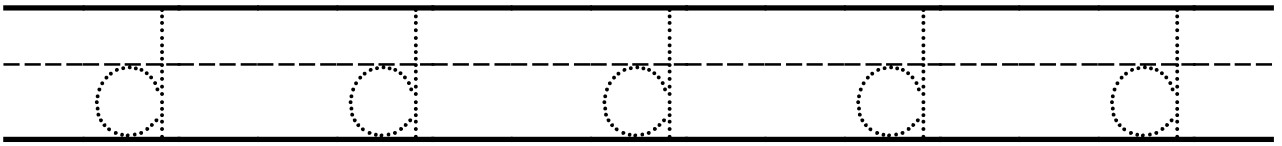
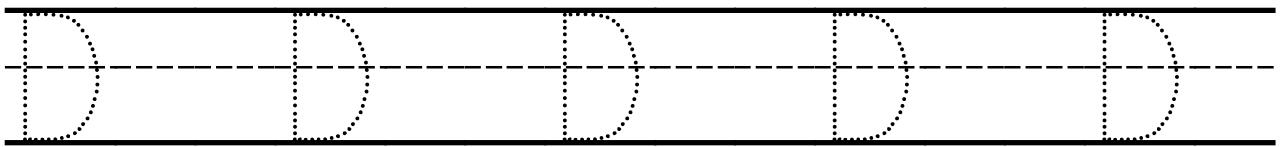
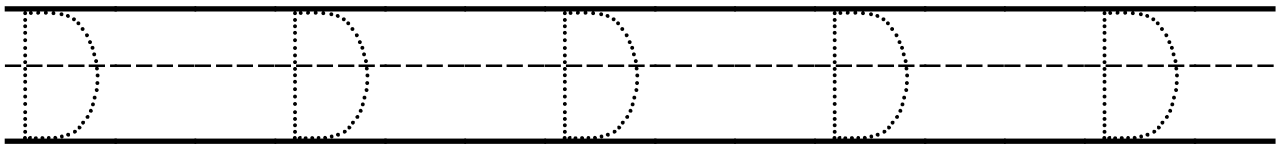
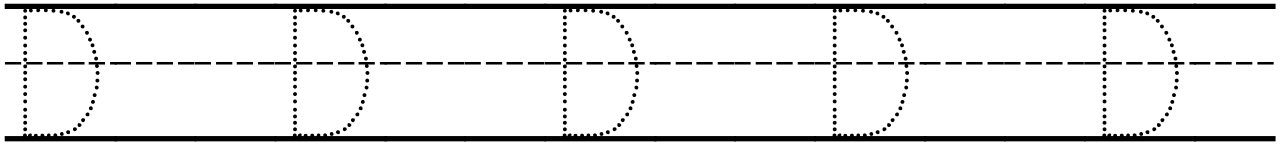
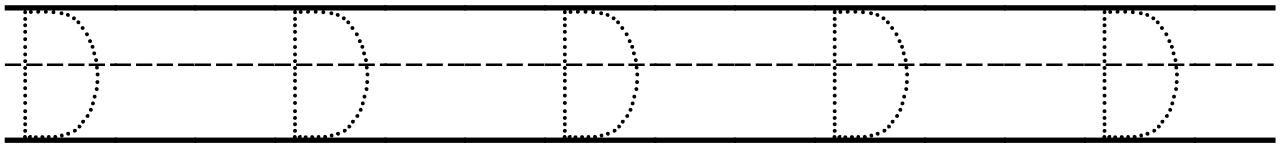

Nom _____ Date _____

Ecris la lettre D/d

D D D D D

Handwriting practice lines for uppercase letter D. The first set of lines is a solid top line, a dashed middle line, and a solid bottom line. The second set of lines is a solid top line, a dashed middle line, and a solid bottom line.

d d d d d

Handwriting practice lines for lowercase letter d. The first set of lines is a solid top line, a dashed middle line, and a solid bottom line. The second set of lines is a solid top line, a dashed middle line, and a solid bottom line.

Nom _____

Date _____

Colorie la lettre D

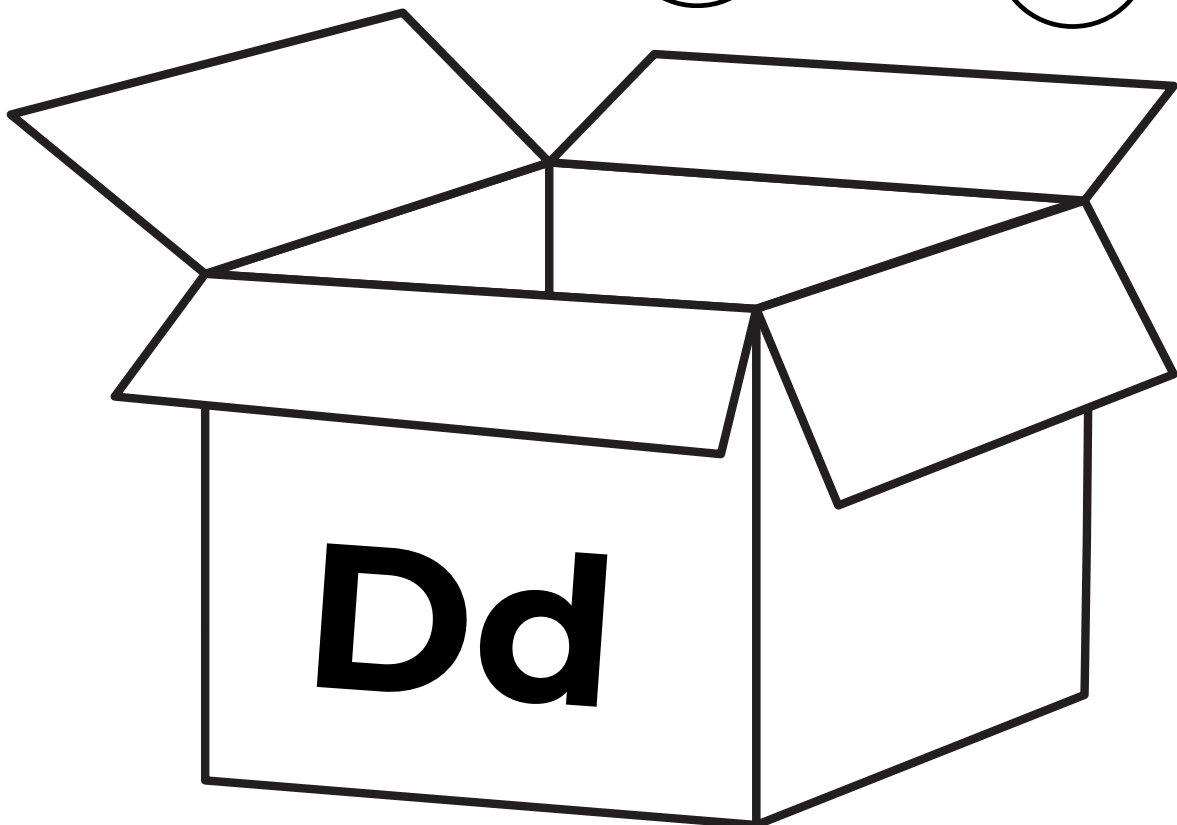
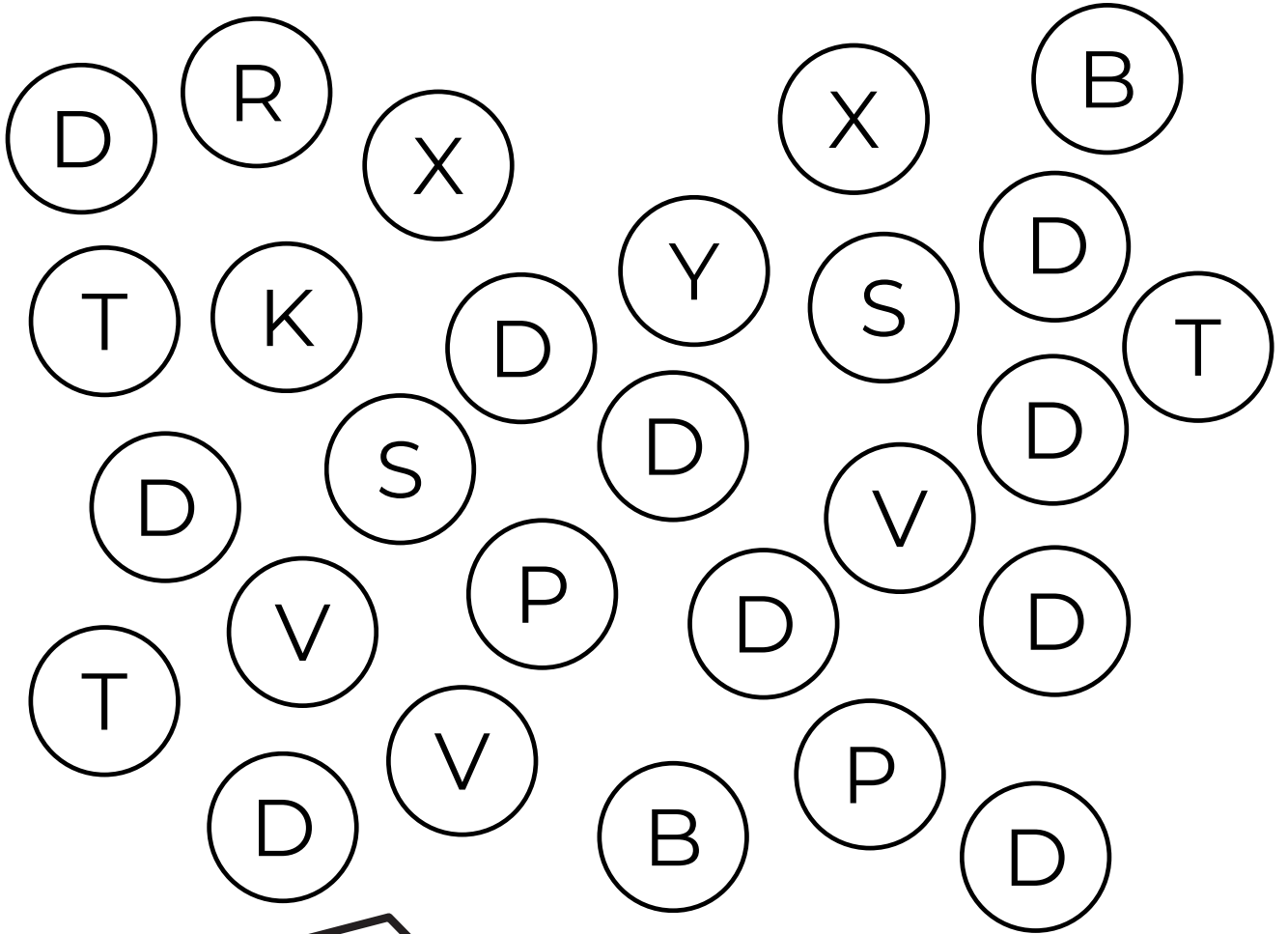

Nom _____

Date _____

Colorie la lettre d

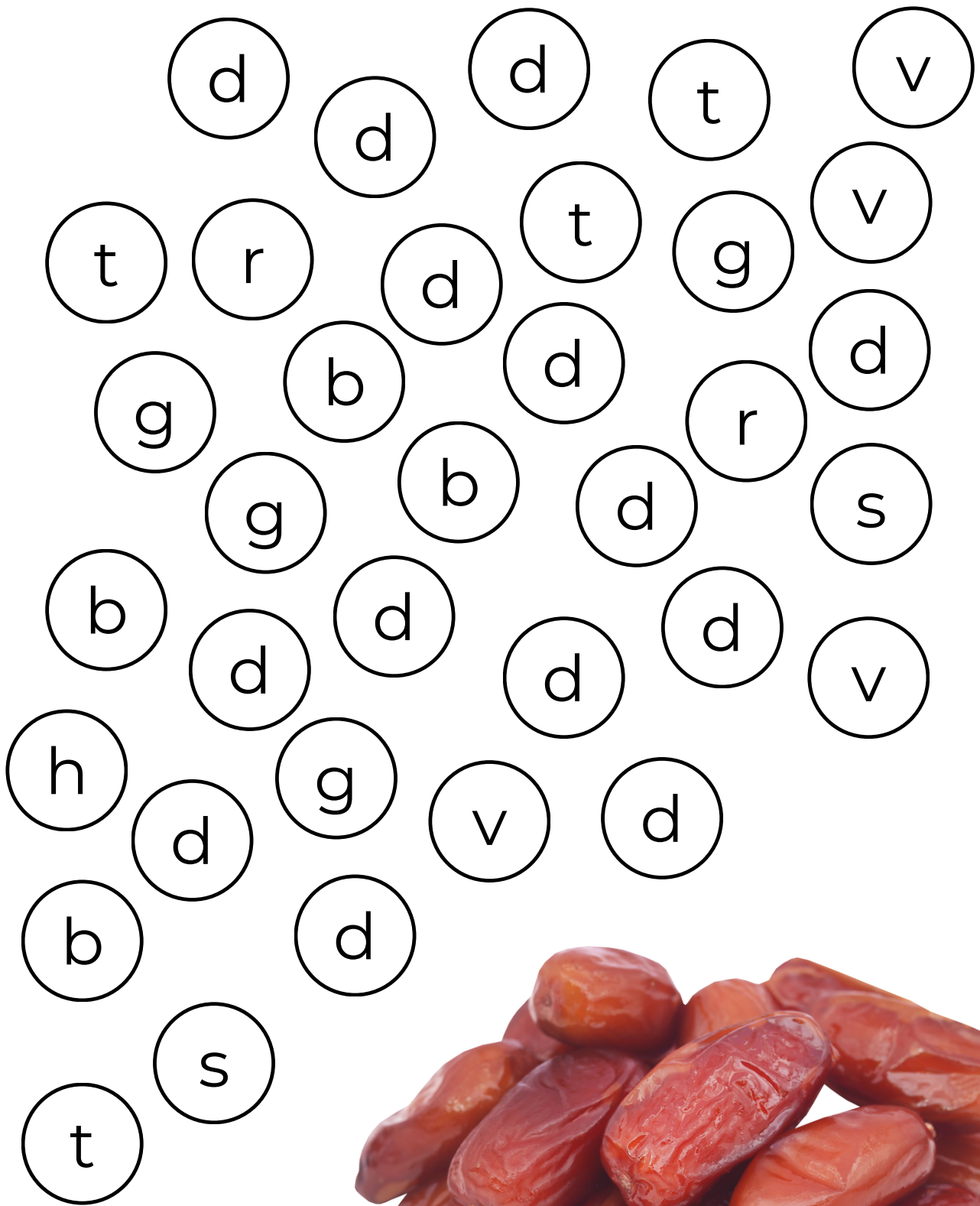

DATTES / dattes

Nom _____

Date _____

Repasse sur la lettre E / e

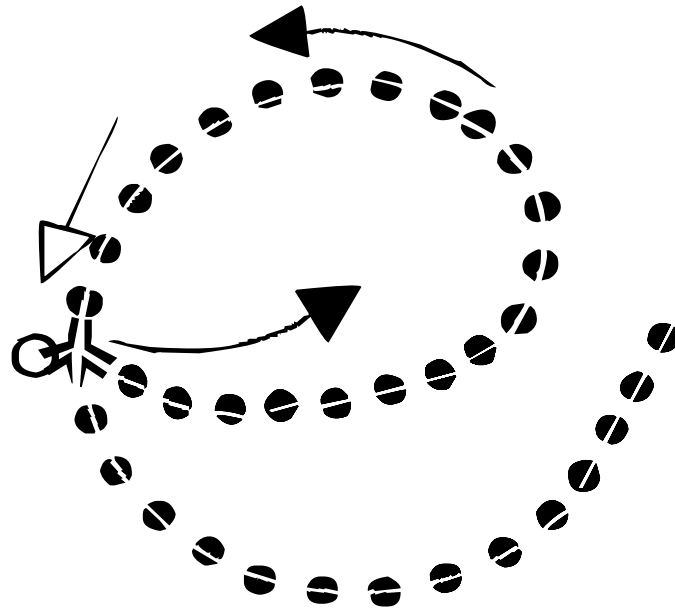

Nom _____

Date _____

Repasse sur la lettre E / e

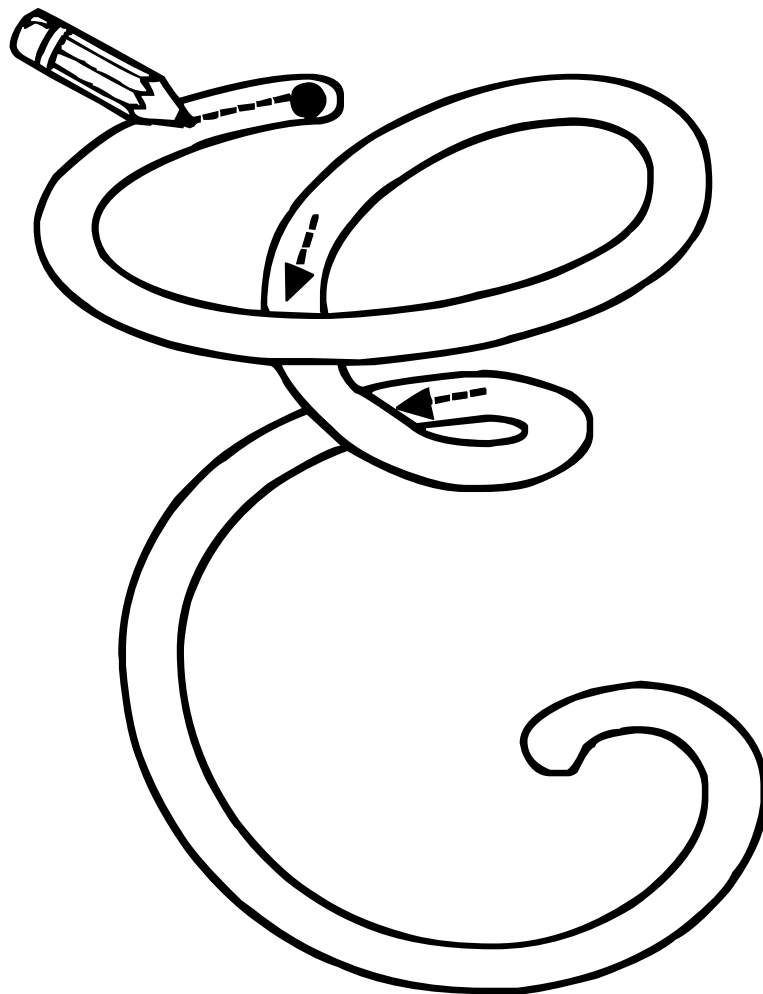

Nom _____

Date _____

Repasse sur la lettre E / e

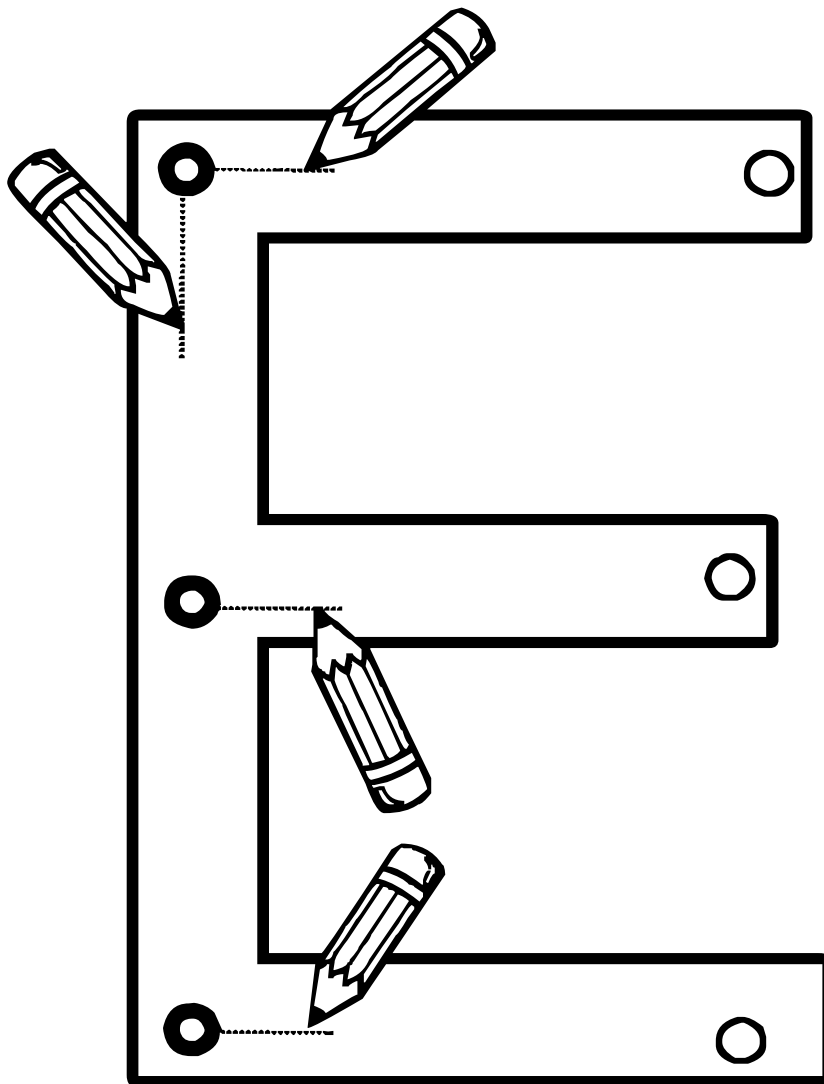

Nom _____

Date _____

Ecris la lettre E / e

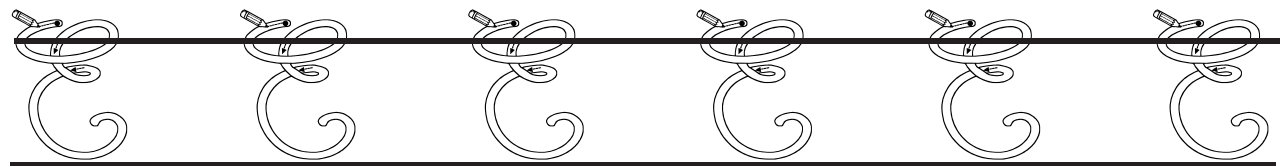
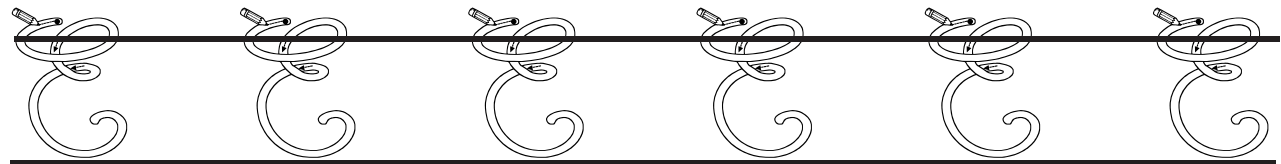
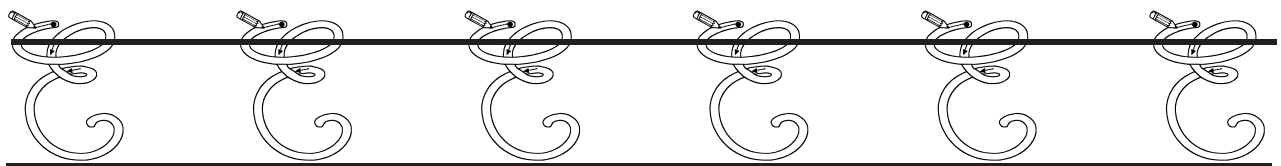
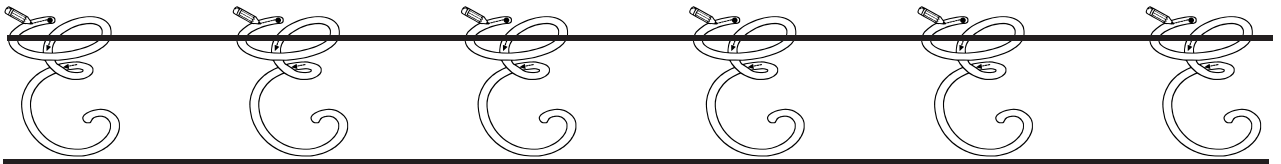
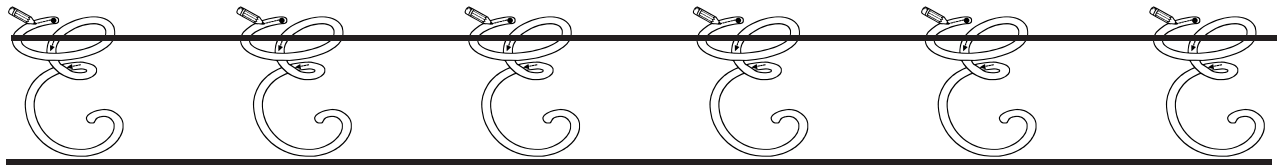
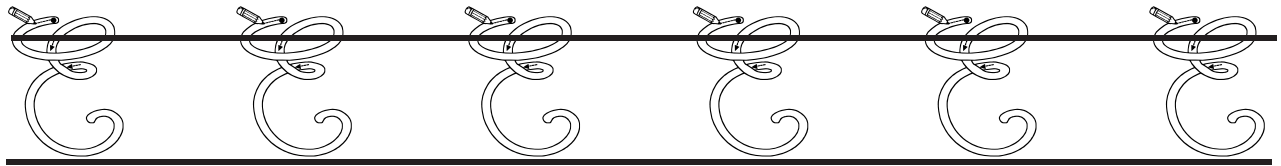
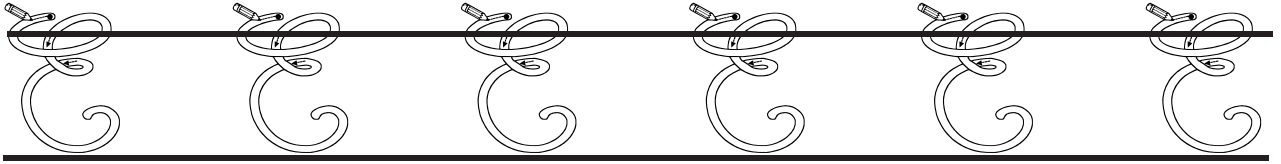

Nom _____ Date _____

Ecris la lettre E / e



Nom _____ Date _____

Ecris la lettre E/e

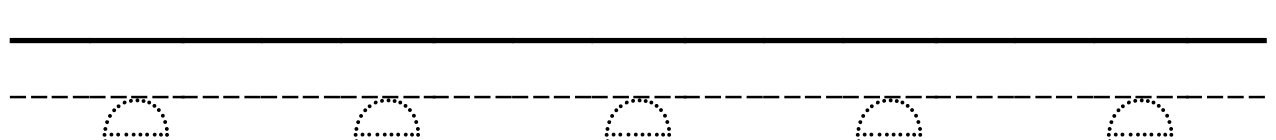
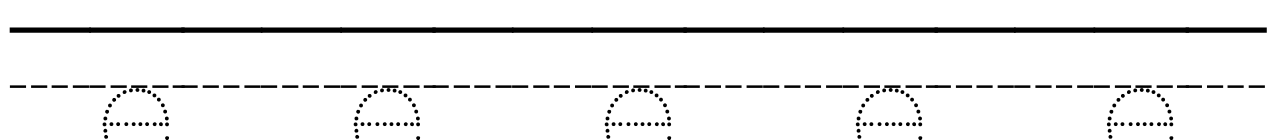
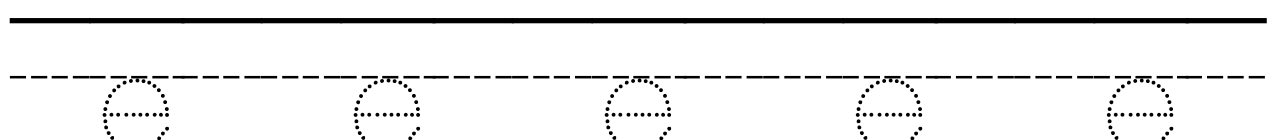
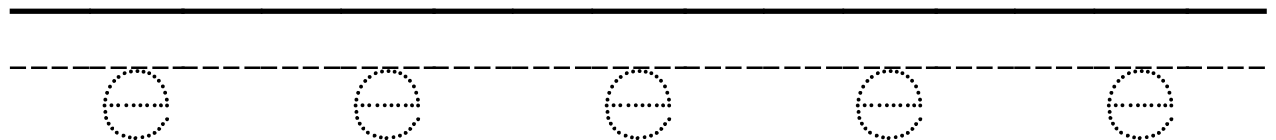
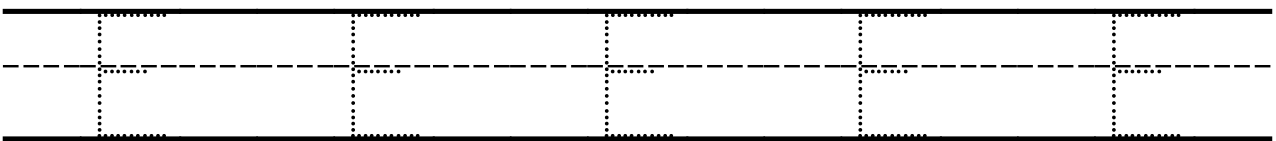
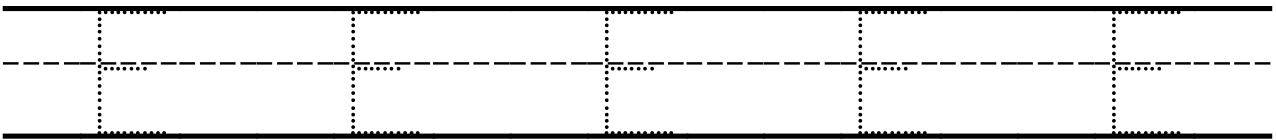
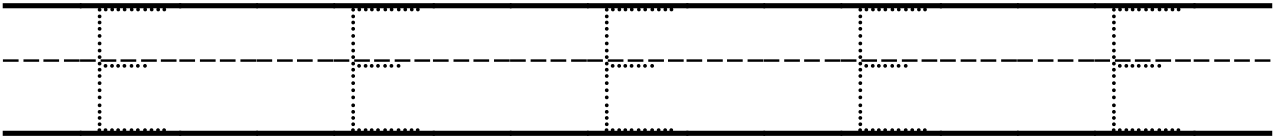
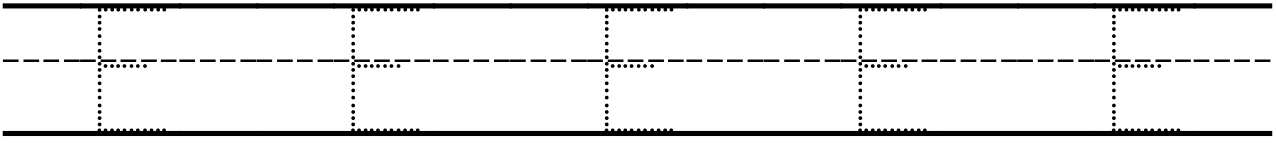

Nom _____ Date _____

Ecris la lettre E/e

E E E E E

Handwriting practice lines for uppercase 'E'. Each set consists of a solid top line, a dashed middle line, and a solid bottom line. There are two such sets provided for practice.

e e e e e

Handwriting practice lines for lowercase 'e'. Each set consists of a solid top line, a dashed middle line, and a solid bottom line. There are two such sets provided for practice.

Nom _____ Date _____

Colorie la lettre E

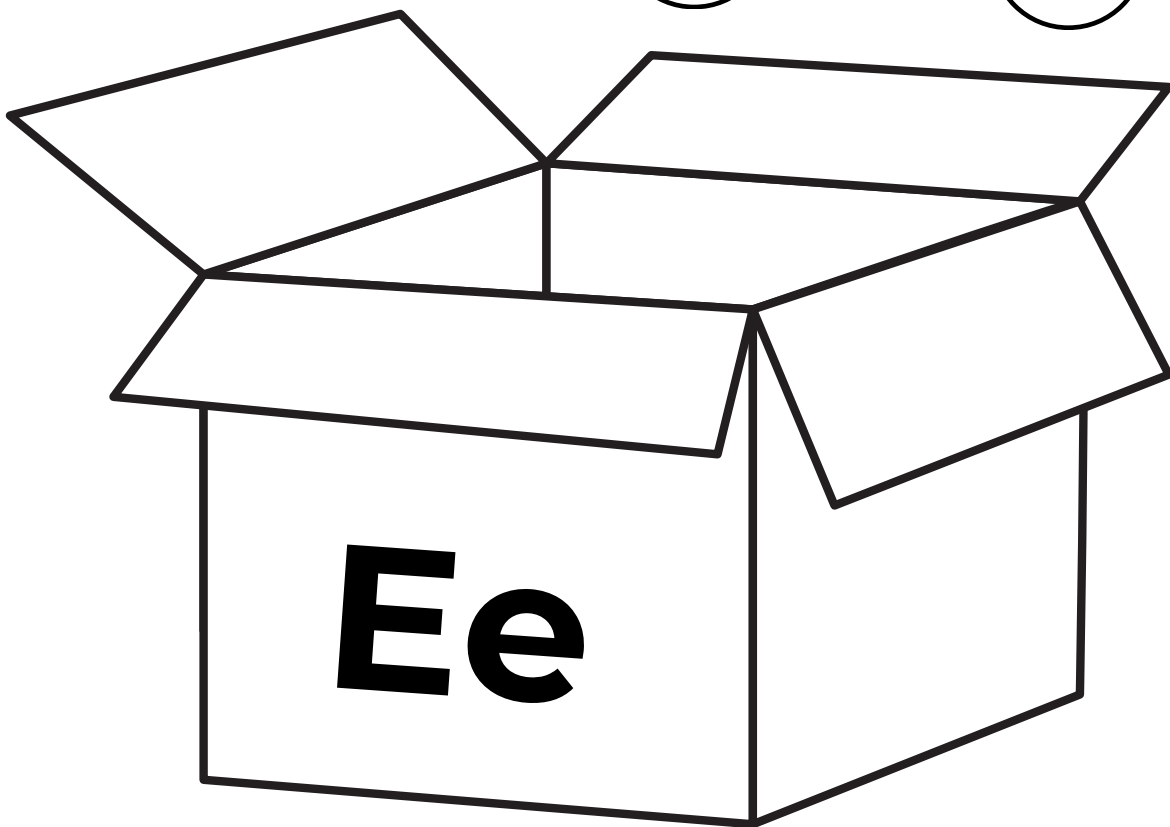
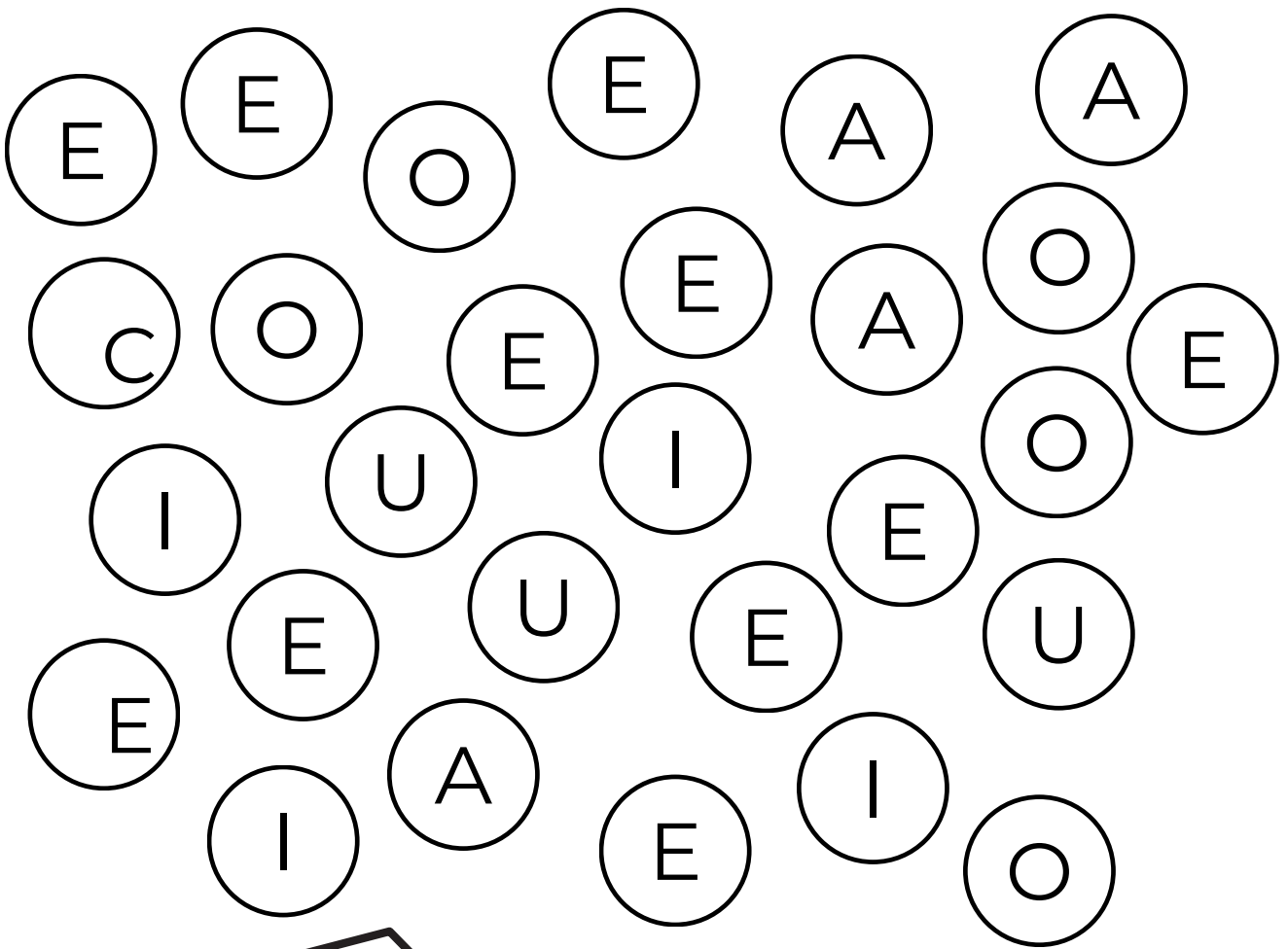

Nom _____

Date _____

Colorie la lettre e

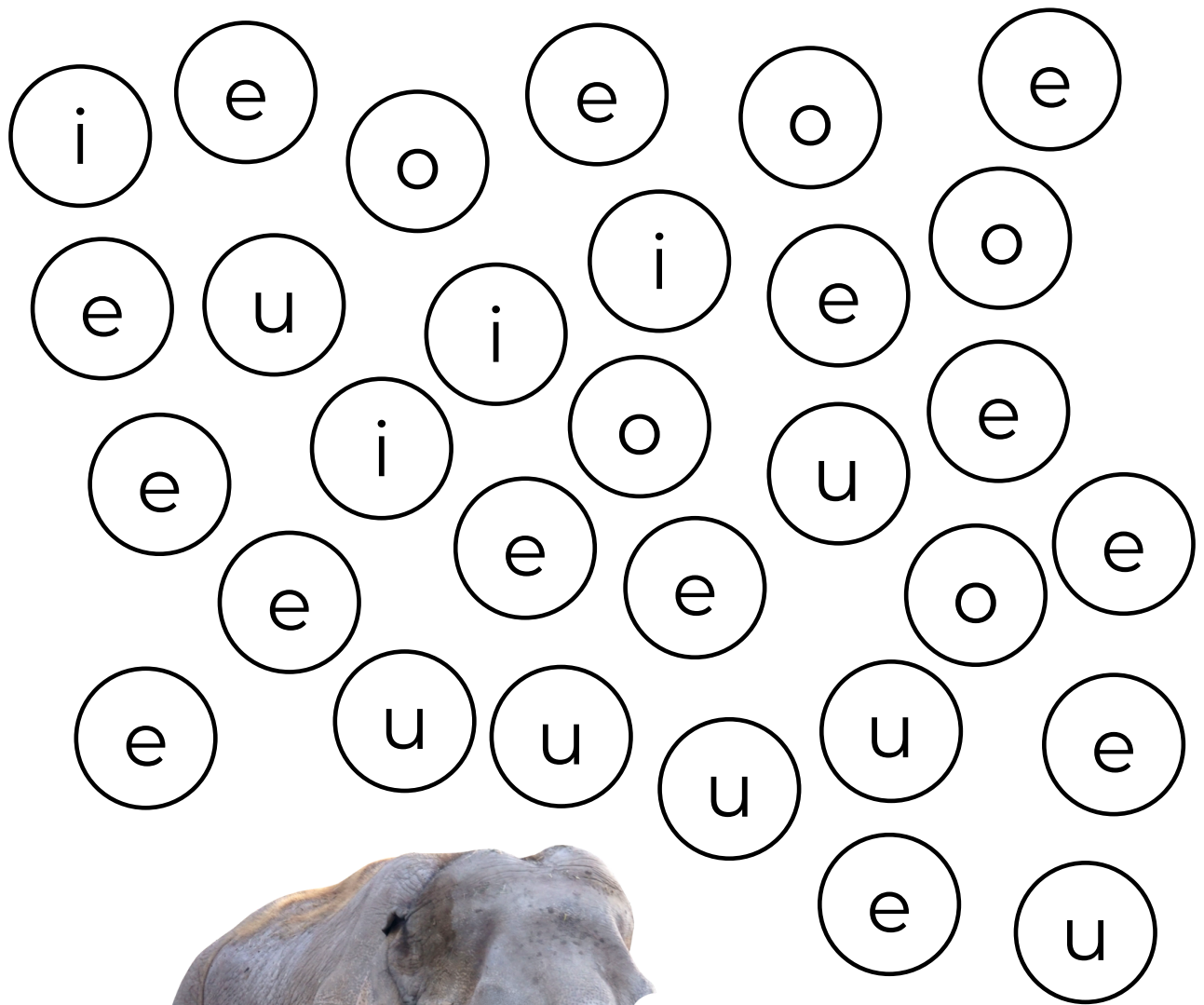

Eléphant / éléphant

Nom _____

Date _____

Repasse sur la lettre F / f

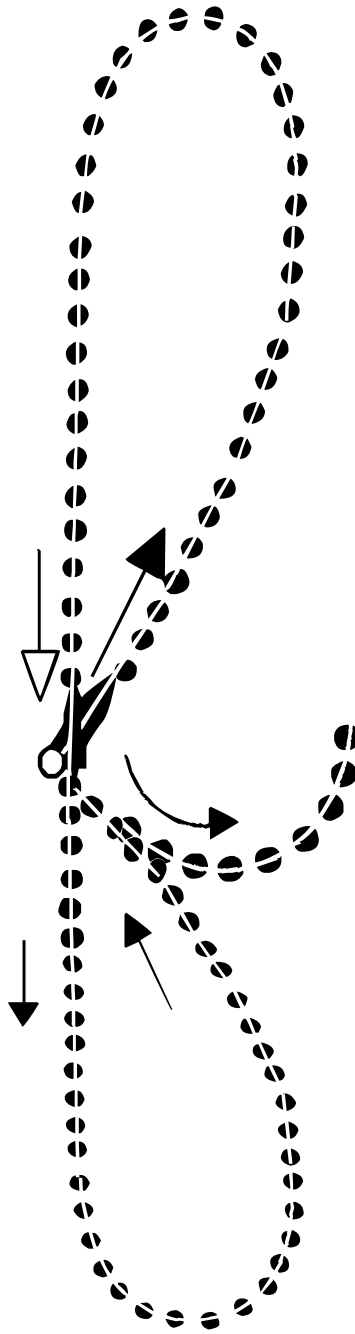

Nom _____

Date _____

Repasse sur la lettre F / f

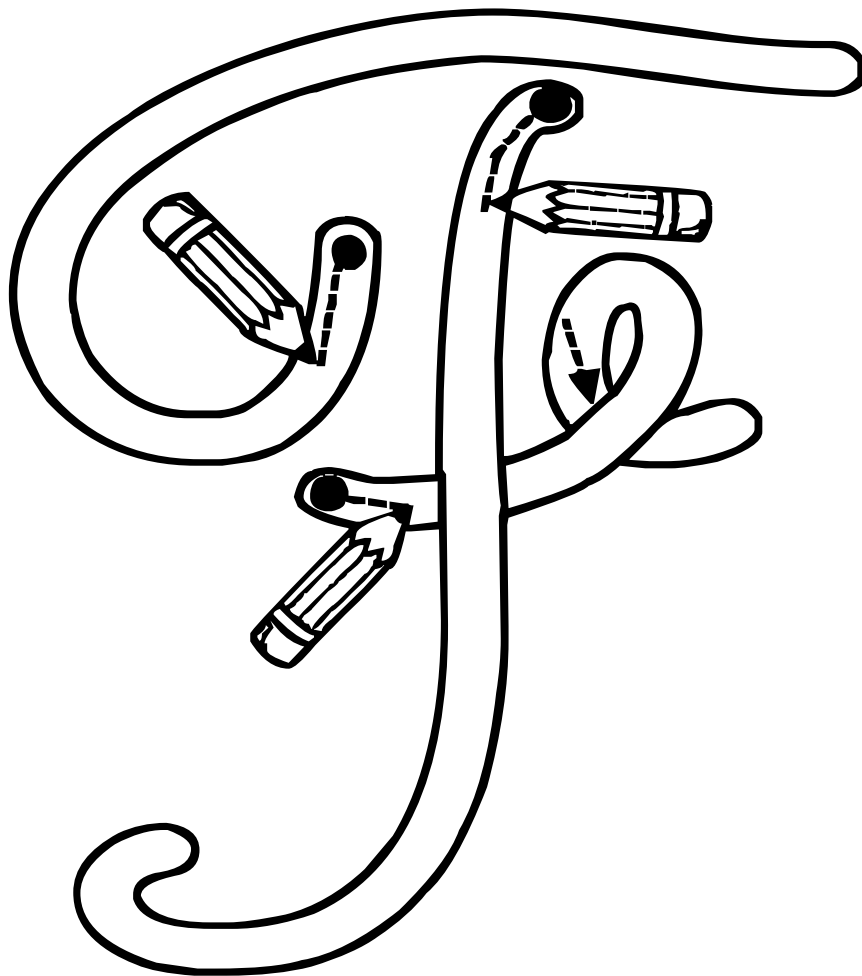

Nom _____

Date _____

Repasse sur la lettre F / f

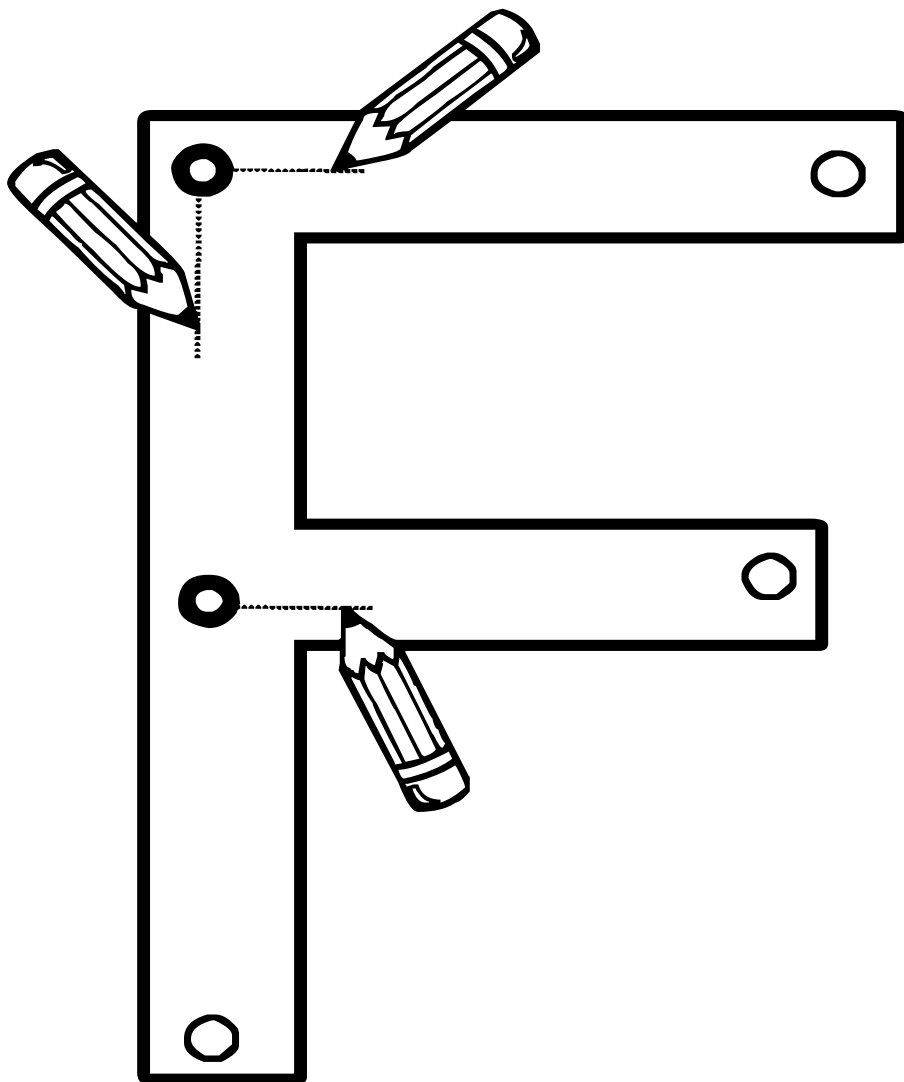

Nom _____

Date _____

Ecris la lettre F / f

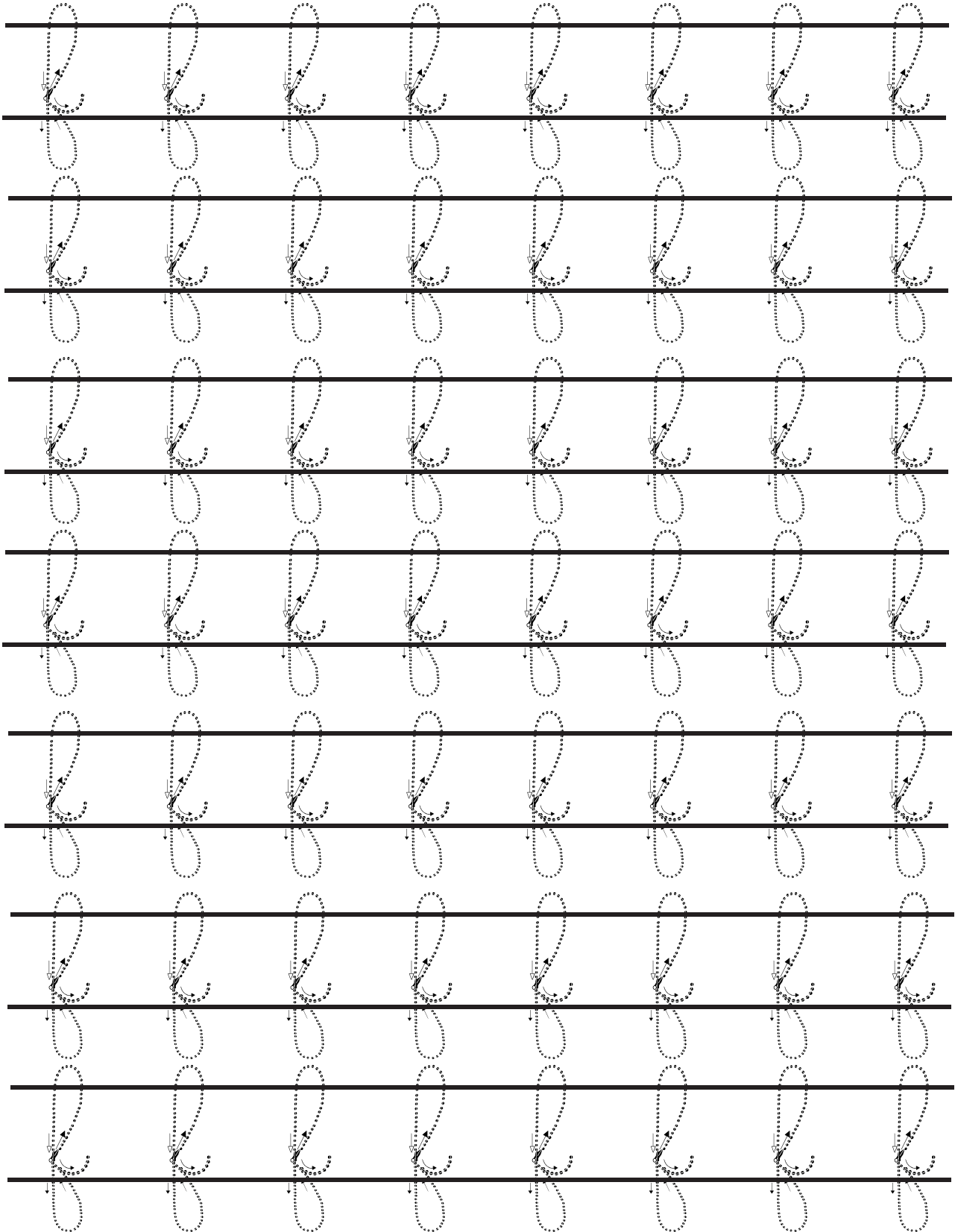

Nom _____

Date _____

Ecris la lettre F / f

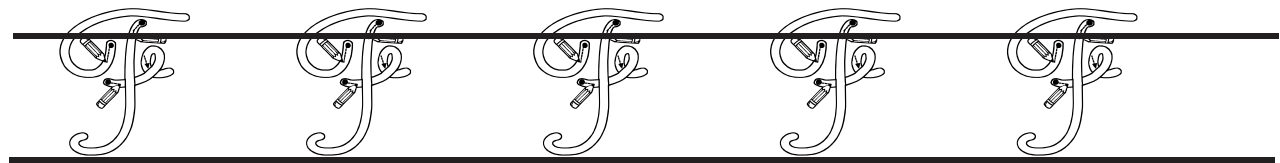
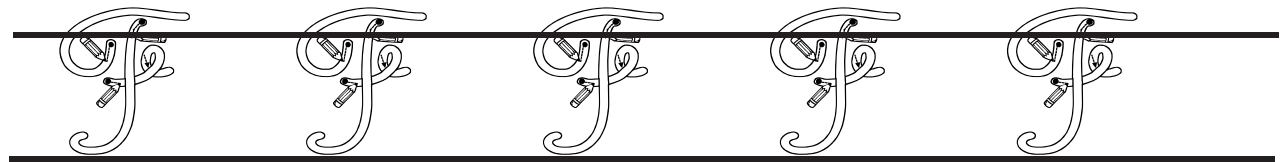
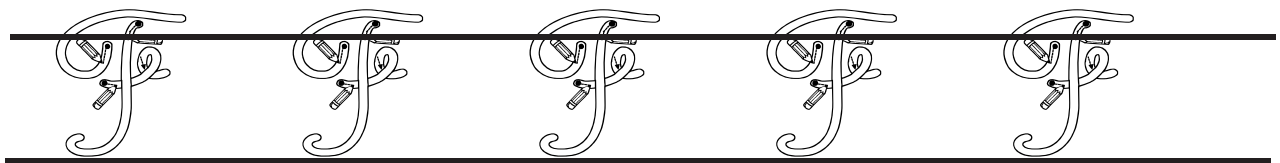
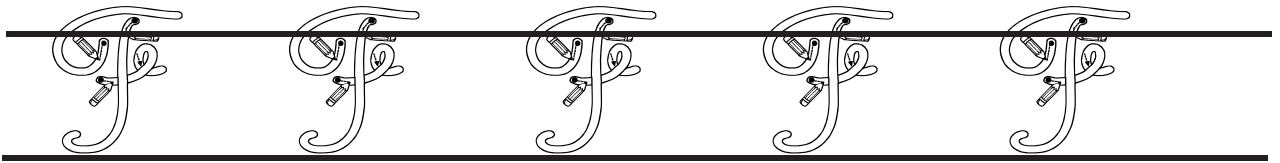
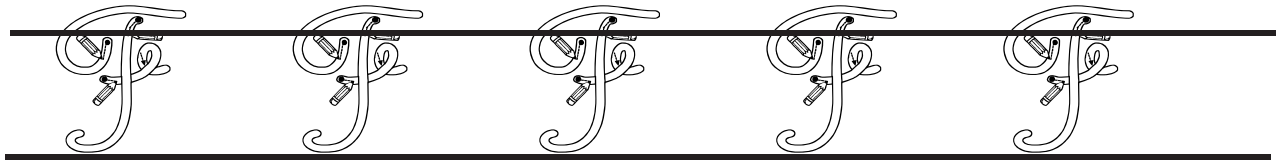
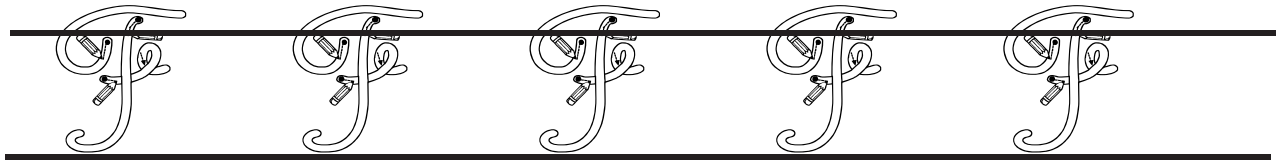
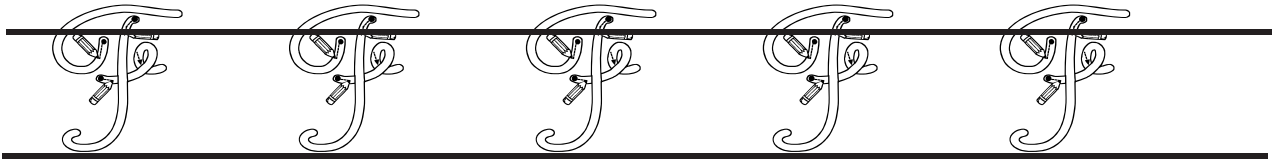

Nom _____

Date _____

Ecris la lettre F/f

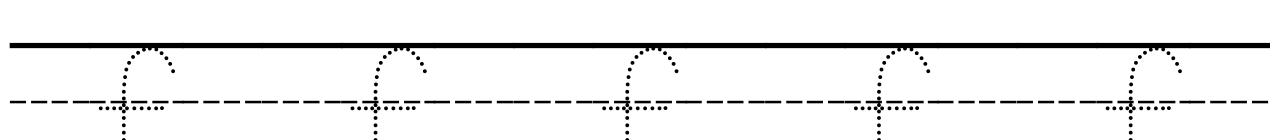
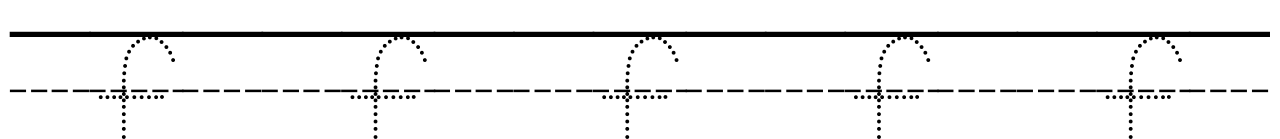
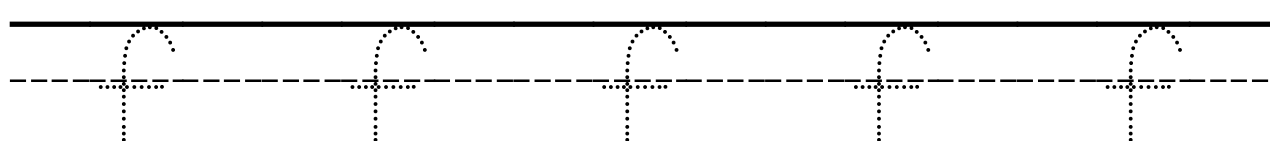
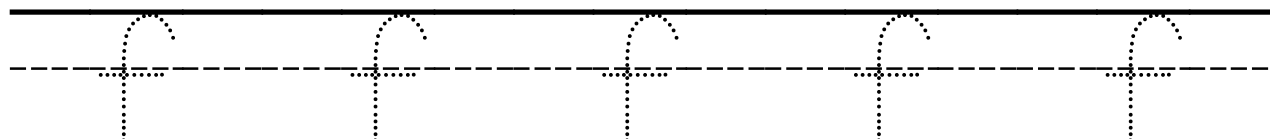
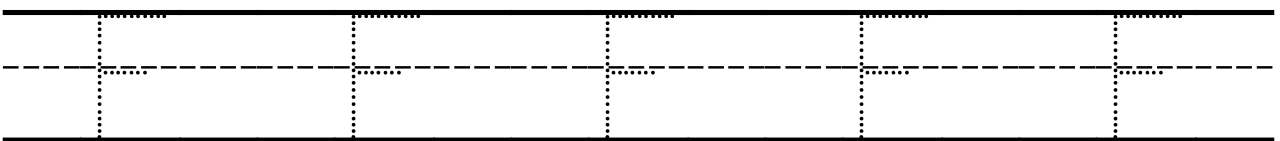
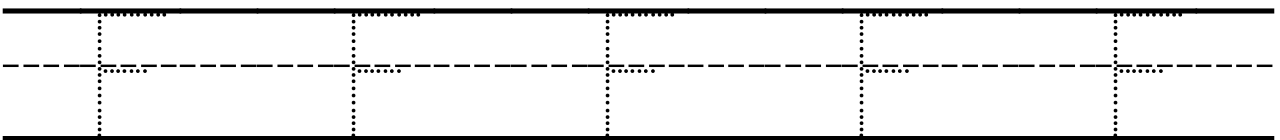
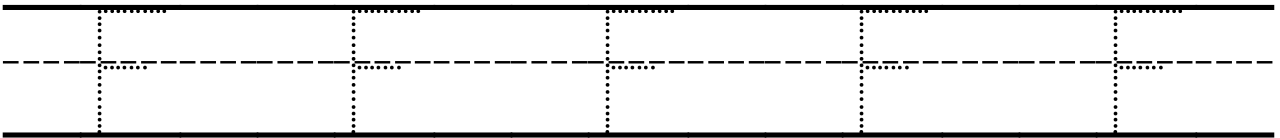
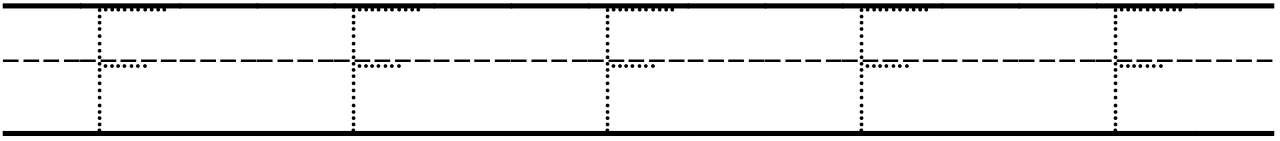

Nom _____ Date _____

Ecris la lettre F/f

F F F F F

Handwriting practice lines for uppercase 'F'. The first set consists of a solid top line, a dashed middle line, and a solid bottom line. The second set consists of a solid top line, a dashed middle line, and a solid bottom line.

f f f f f

Handwriting practice lines for lowercase 'f'. The first set consists of a solid top line, a dashed middle line, and a solid bottom line. The second set consists of a solid top line, a dashed middle line, and a solid bottom line.

Nom _____

Date _____

Colorie la lettre F

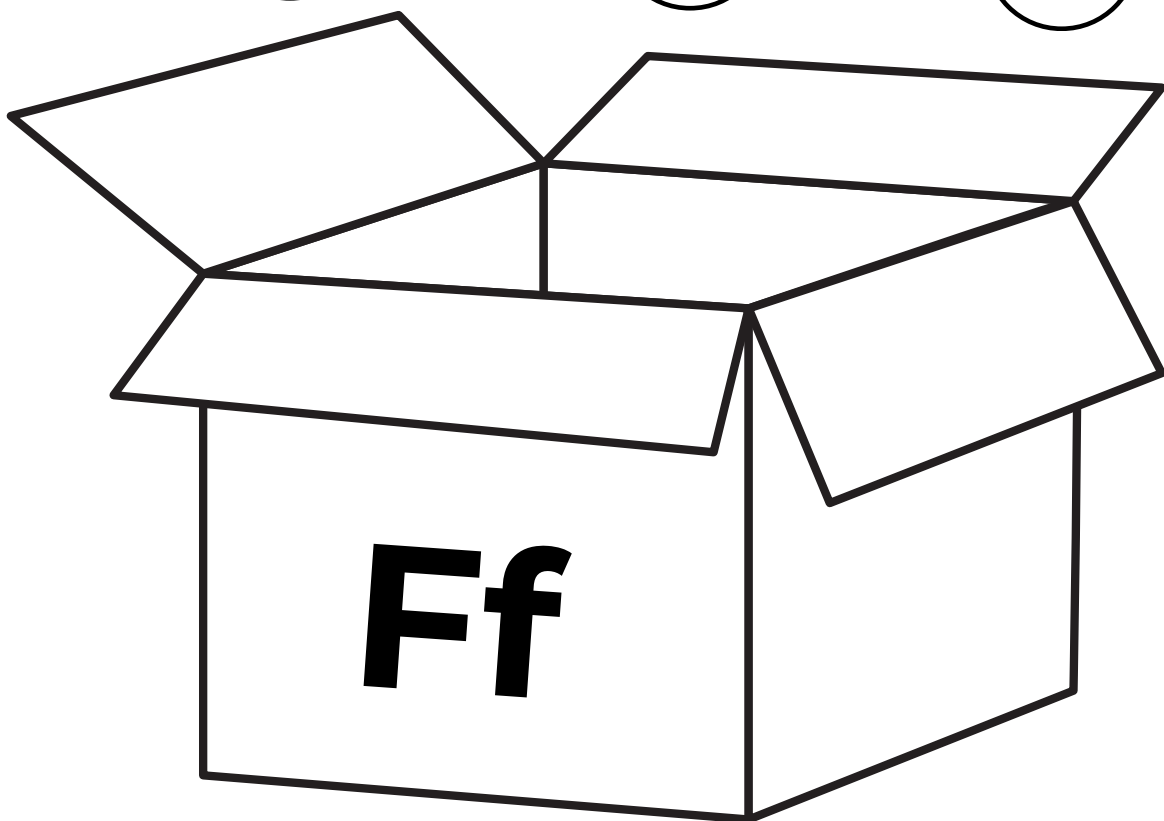
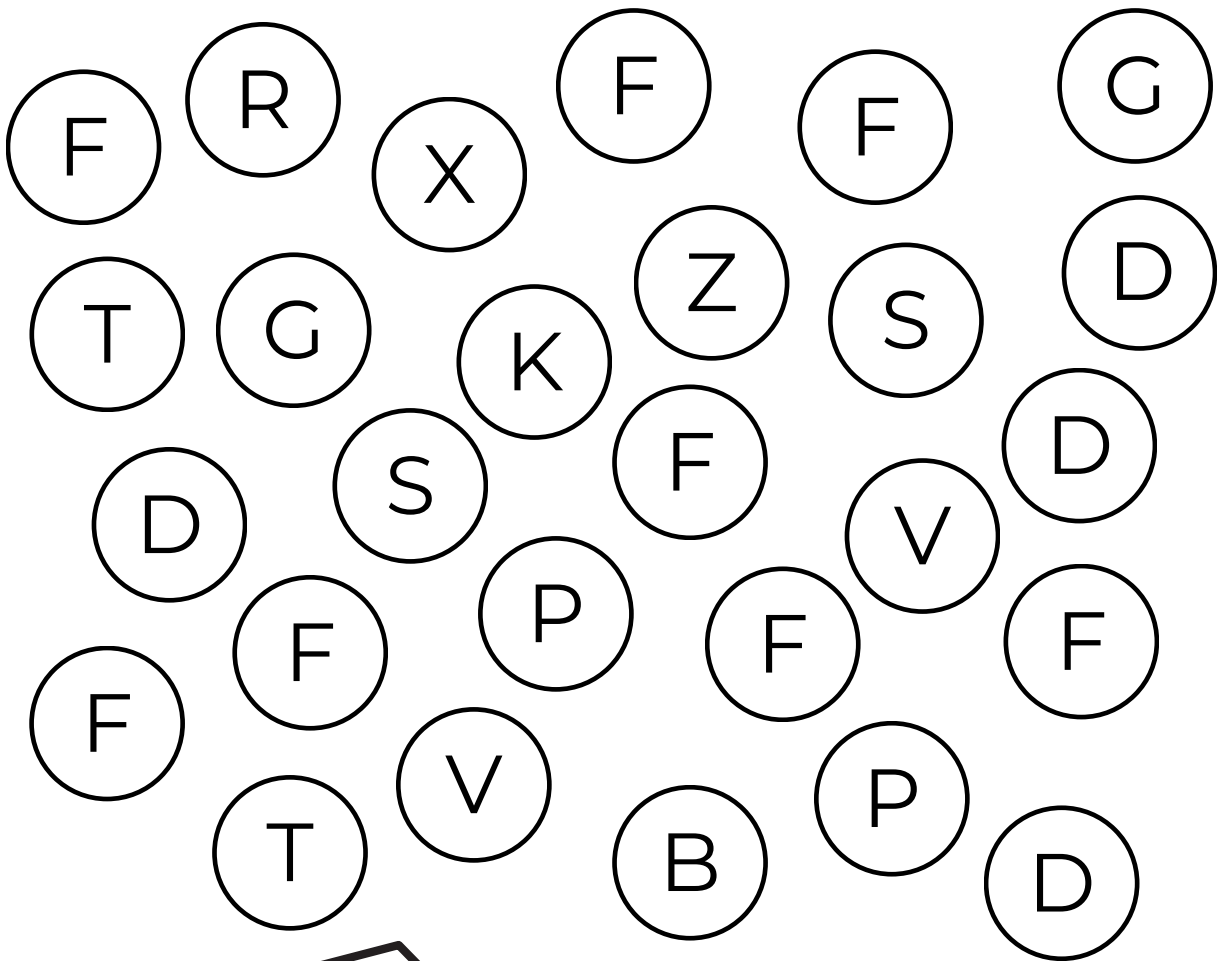

Nom _____

Date _____

Colorie la lettre f

A collection of letters in circles for coloring. The letters are: s, f, p, q, q, f, q, r, t, q, g, v, g, b, f, r, f, g, s, p, s, b, f, f, f, f, x, f, f, g, p, b, f, f, w, p, f, p.



FIGUE / figue

Nom _____

Date _____

Repasse sur la lettre G / g

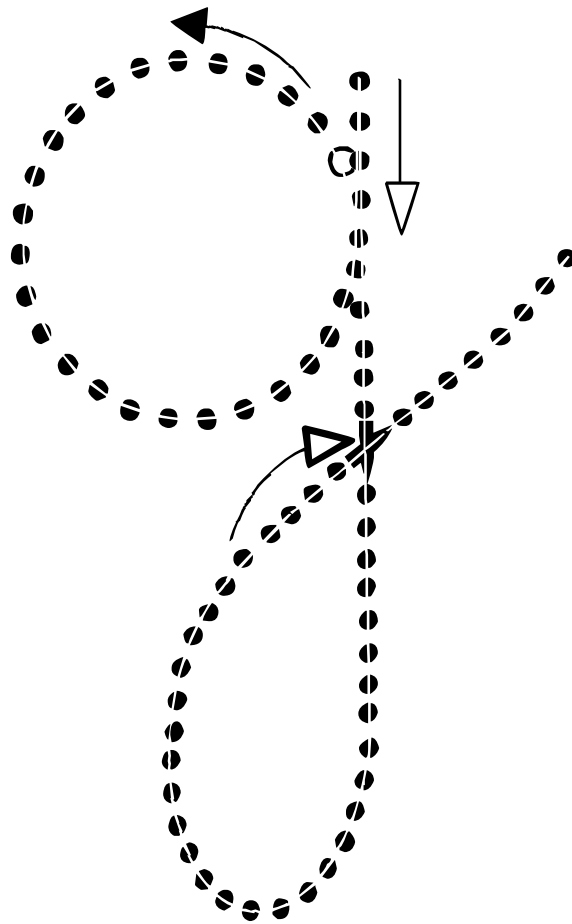

Nom _____

Date _____

Repasse sur la lettre G / g

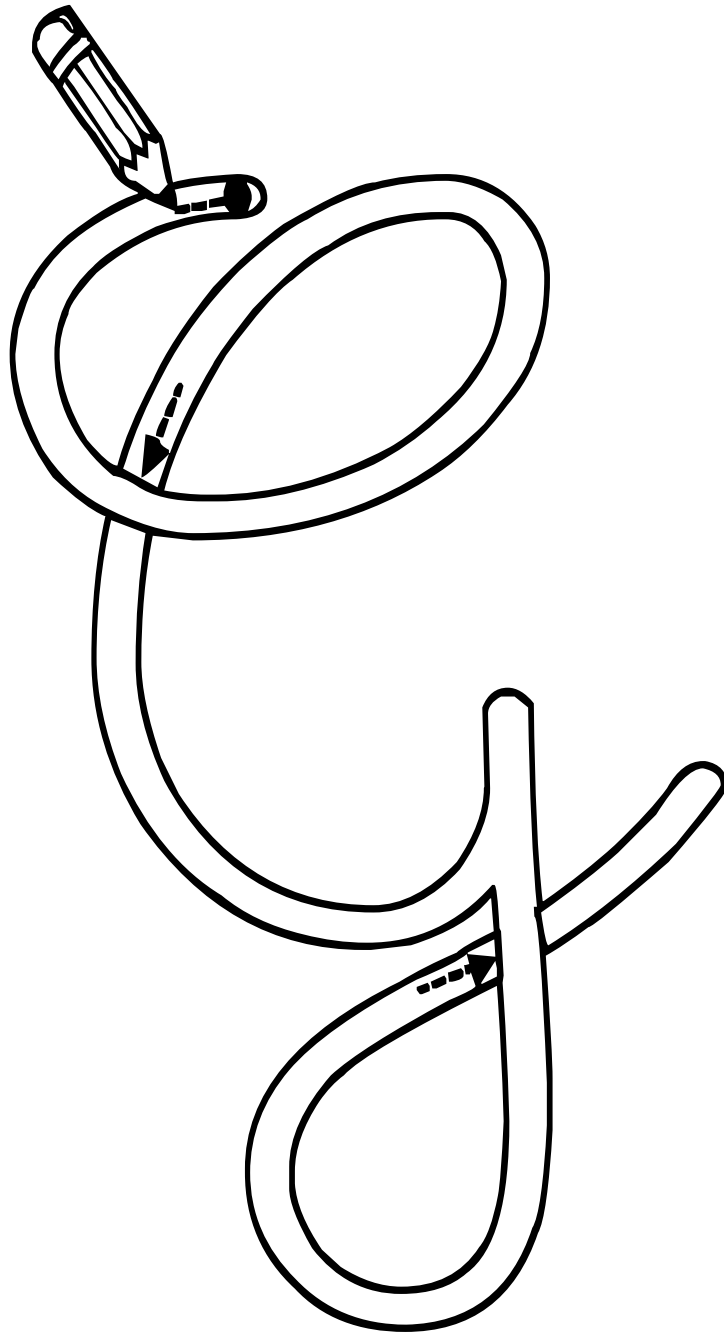

Nom _____

Date _____

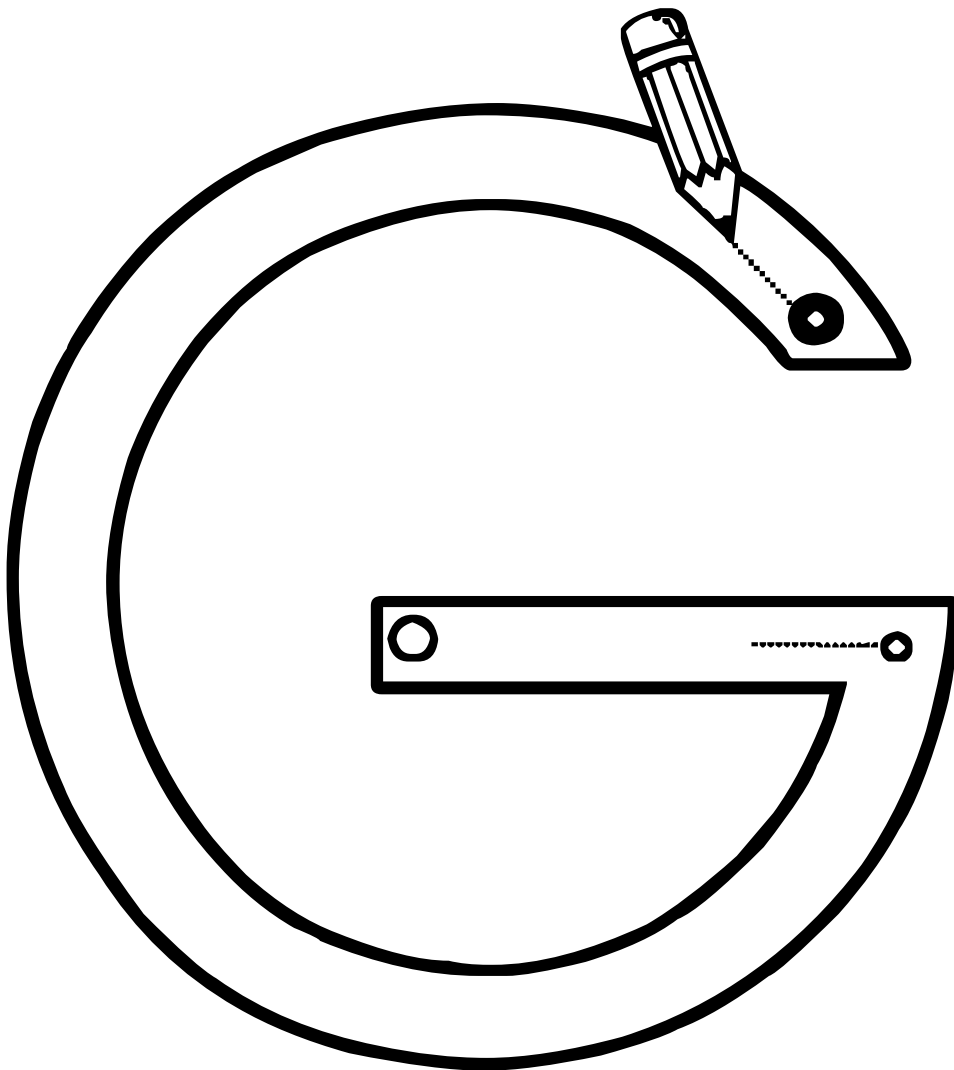

Repasse sur la lettre G / g



Nom _____

Date _____

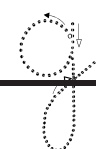
Ecris la lettre G / g

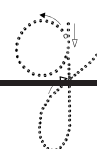
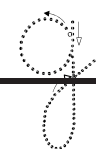
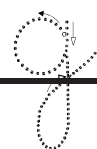
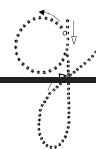
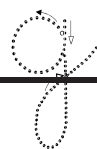
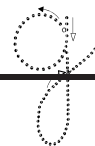
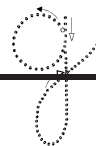
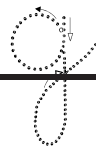
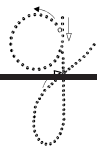
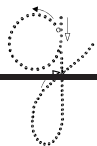
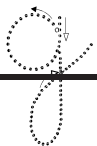
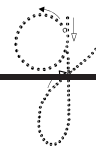
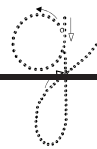
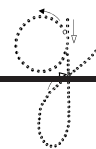
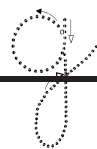
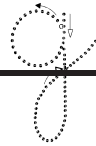
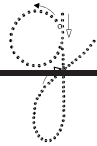
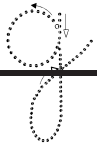

Nom _____

Date _____

Ecris la lettre G / g

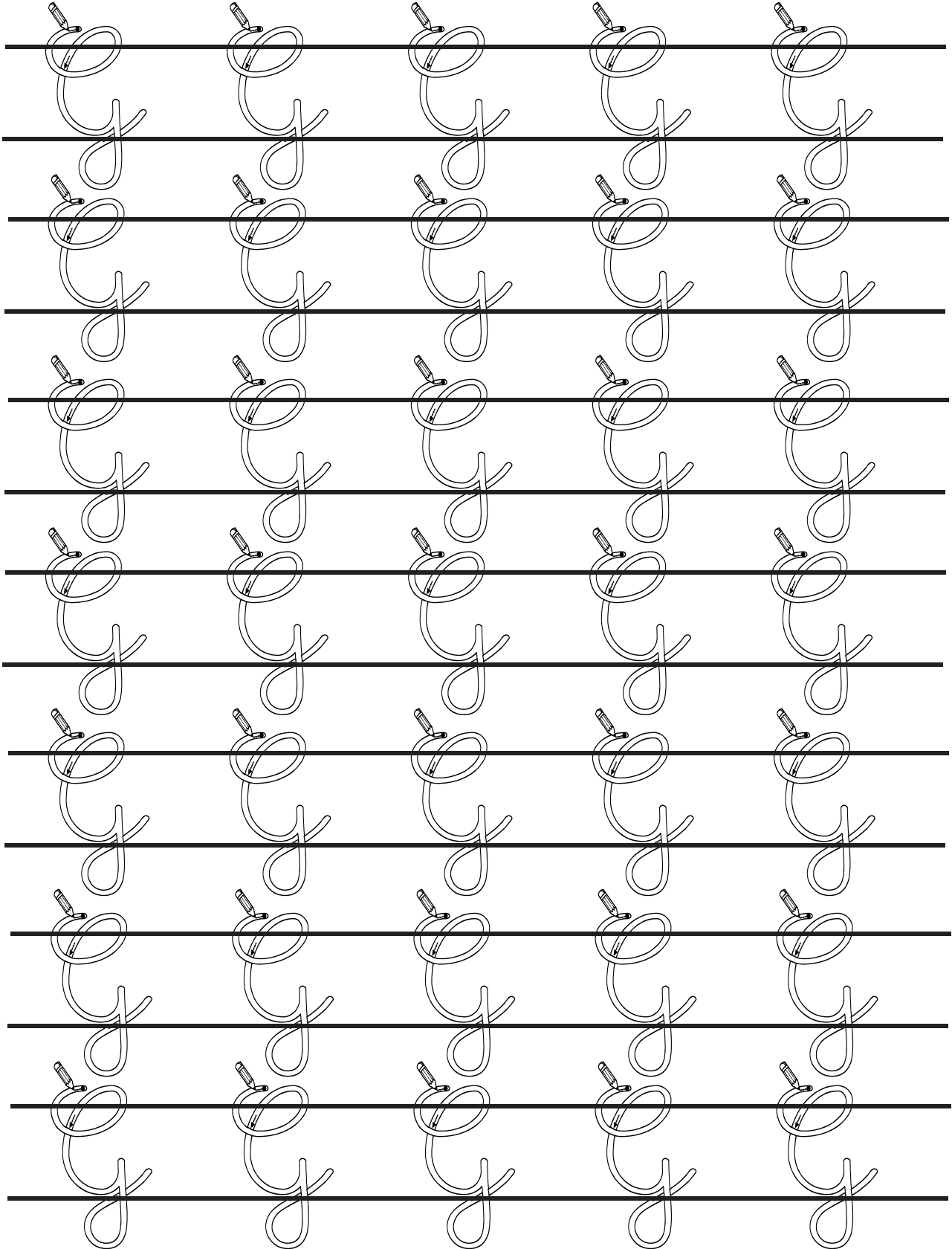

Nom _____

Date _____

Ecris la lettre G/g

G

G

G

G

G

G

G

G

G

G

G

G

G

G

G

G

G

G

G

G

g

g

g

g

g

g

g

g

g

g

g

g

g

g

g

g

g

g

g

g

Nom _____ Date _____

Ecris la lettre G/g

G G G G G

Handwriting practice lines for uppercase letter G. The first set of lines is a solid top line, a dashed middle line, and a solid bottom line. The second set of lines is a solid top line, a dashed middle line, and a solid bottom line.

g g g g g

Handwriting practice lines for lowercase letter g. The first set of lines is a solid top line, a dashed middle line, and a solid bottom line. The second set of lines is a solid top line, a dashed middle line, and a solid bottom line.

Nom _____

Date _____

Colorie la lettre G

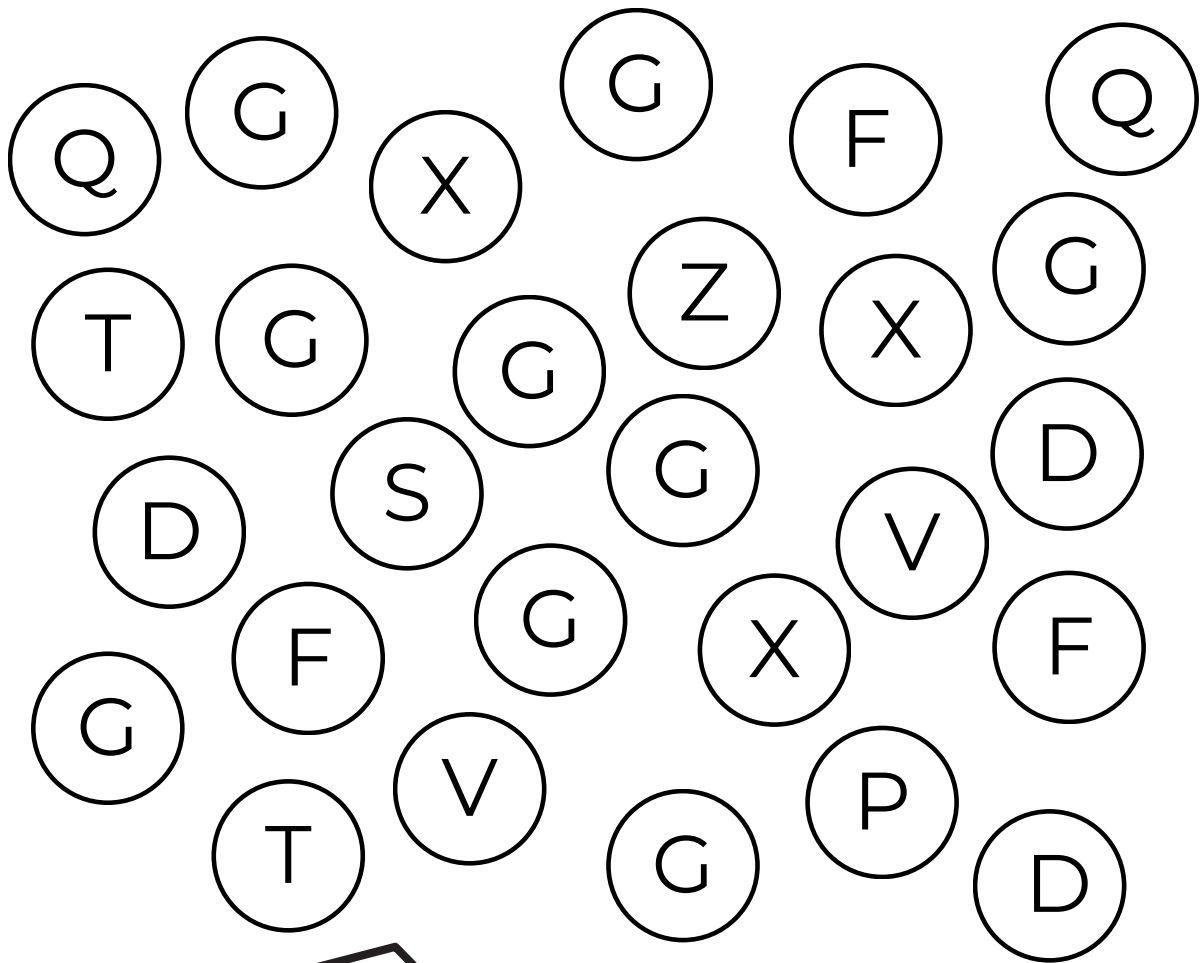

Nom _____

Date _____

Colorie la lettre g

A collection of 35 lowercase letters 'g' scattered across the page, each enclosed in a circle. The letters are arranged in a roughly triangular pattern, with the top row having 6 letters and the bottom row having 2 letters. The letters are: Row 1: s, g, g, g, q, f; Row 2: q, r, s, q, g, s; Row 3: g, b, g, r, f; Row 4: h, s, p, s; Row 5: b, f, g, f, g, x, g; Row 6: f, y, g; Row 7: y, g; Row 8: w, g, p; Row 9: c, g.



GRENADE / grenade

Nom _____

Date _____

Repasse sur la lettre H / h

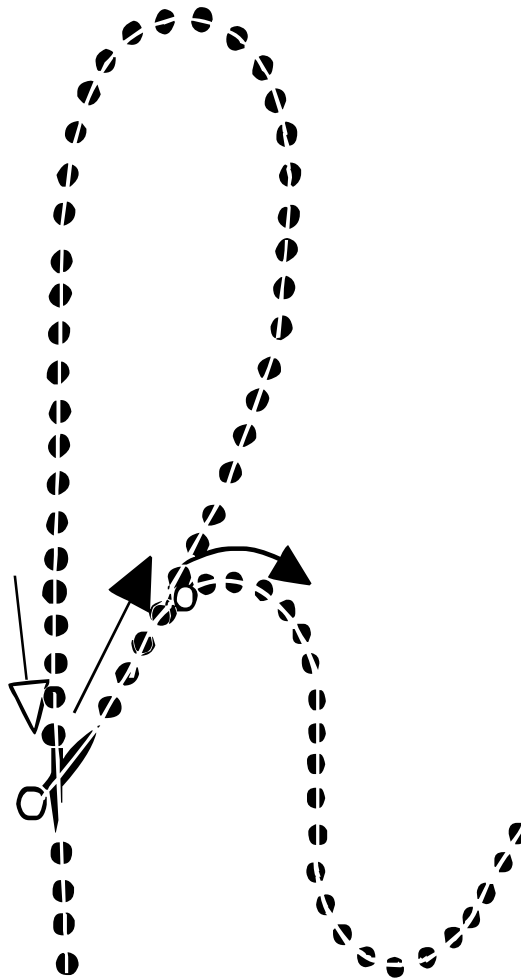

Nom _____

Date _____

Repasse sur la lettre H / h

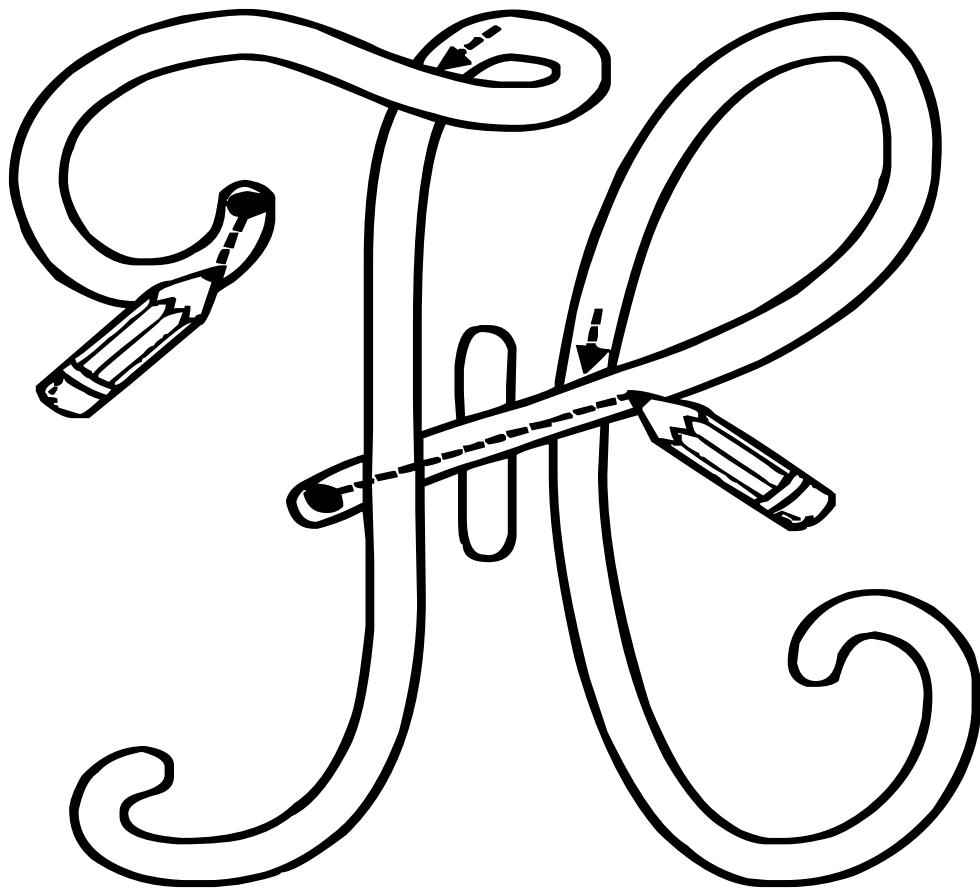

Nom _____

Date _____

Repasse sur la lettre H / h

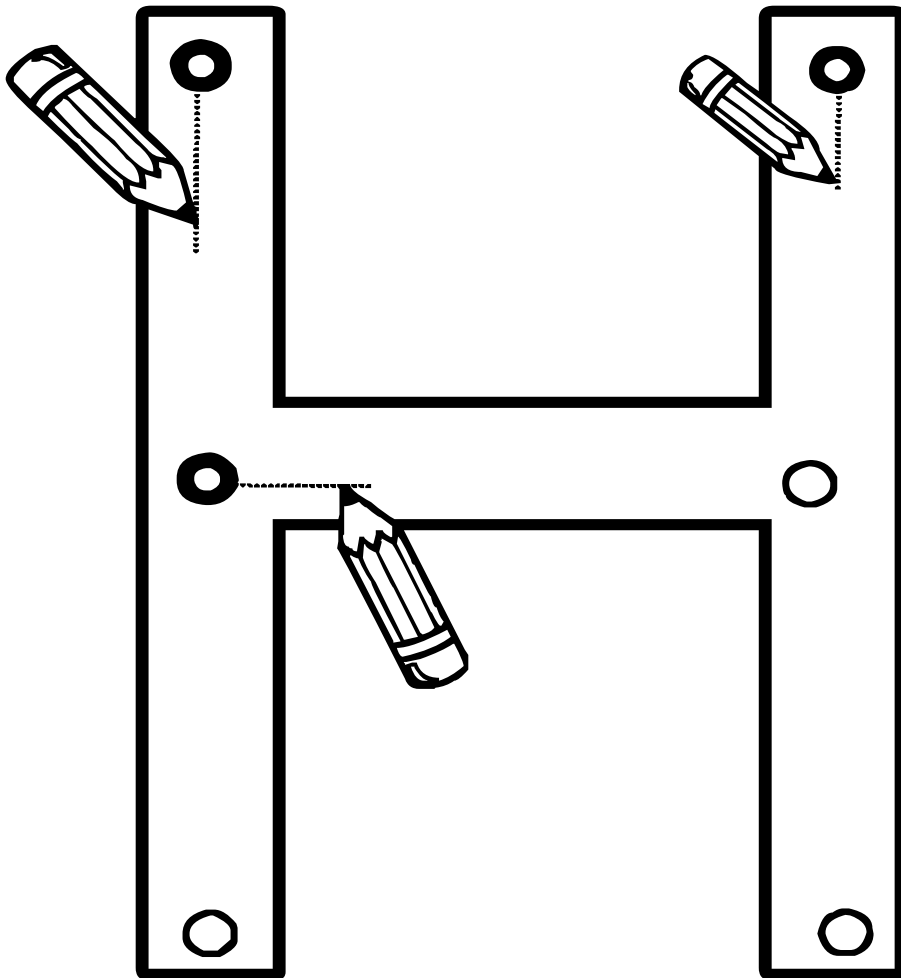

Nom _____

Date _____

Ecris la lettre H / h

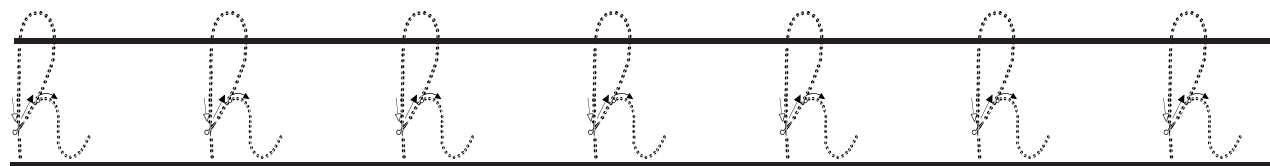
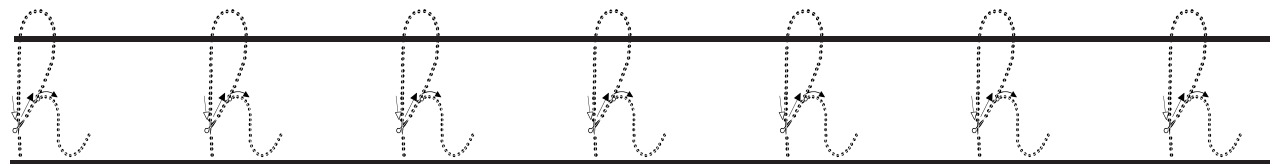
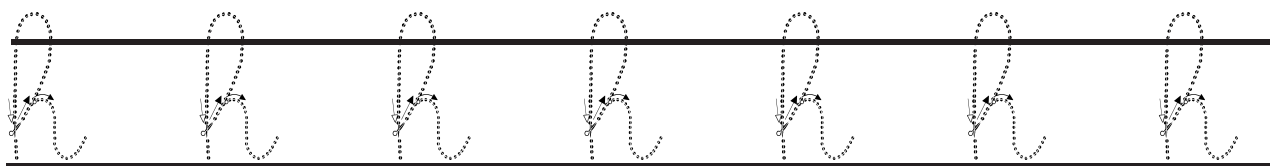
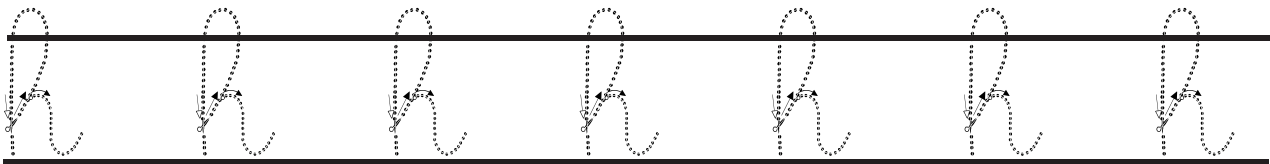
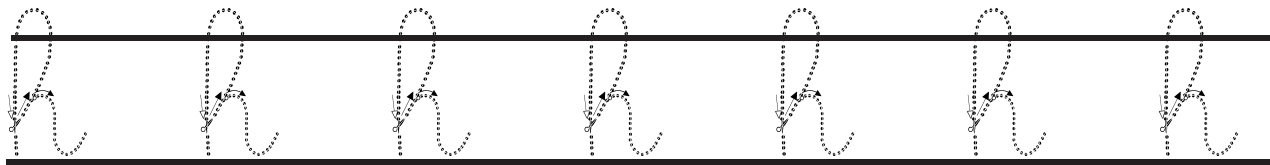
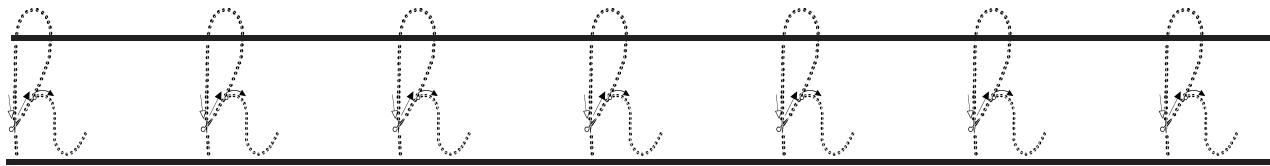
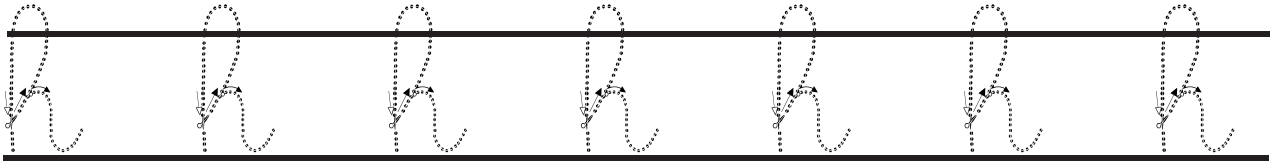

Nom _____

Date _____

Ecris la lettre H/h

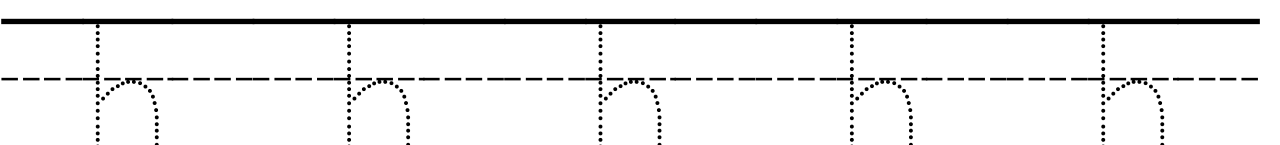
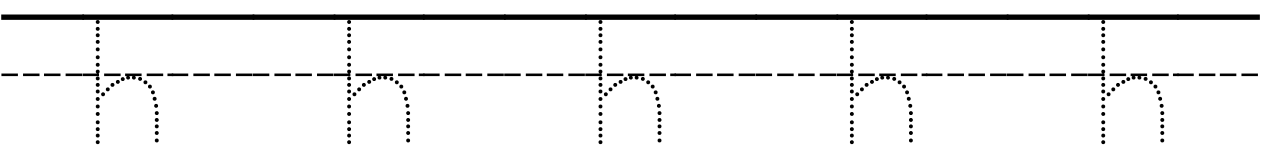
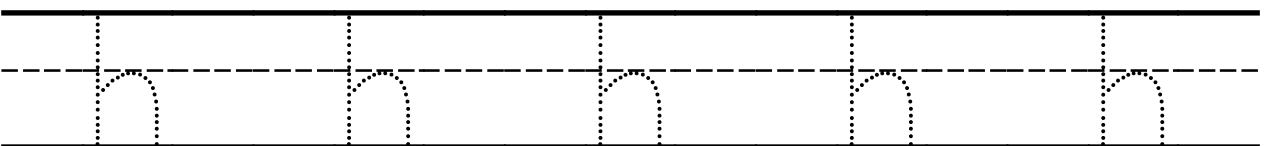
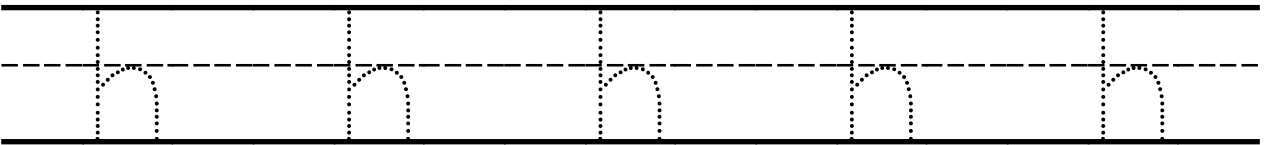
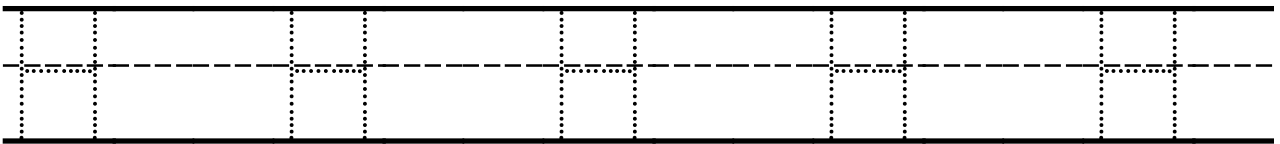
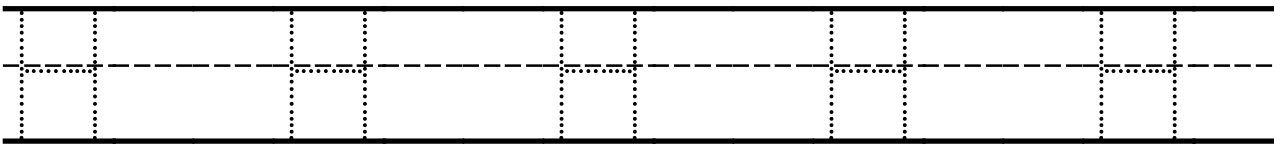
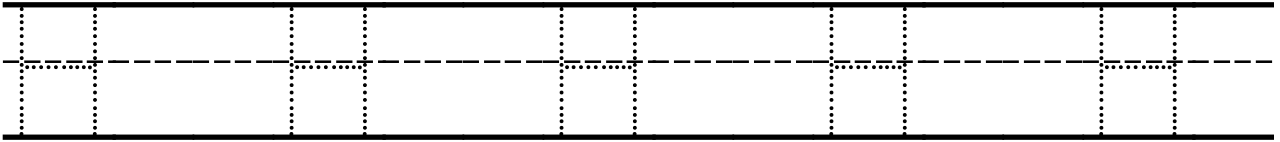
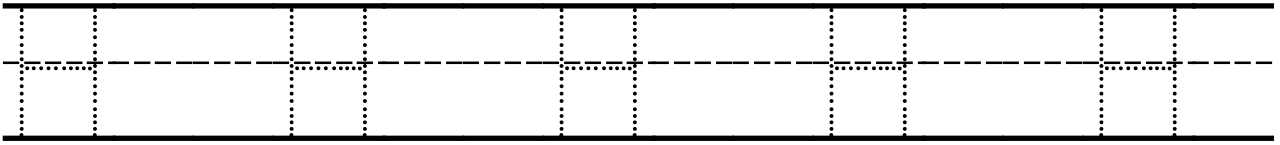

Nom _____ Date _____

Ecris la lettre H/h

H H H H H

Handwriting practice lines for uppercase letter H. The first row is a solid line. The second row is a dashed line. The third row is a solid line. The fourth row is a solid line. The fifth row is a dashed line. The sixth row is a solid line.

h h h h h

Handwriting practice lines for lowercase letter h. The first row is a solid line. The second row is a dashed line. The third row is a solid line. The fourth row is a solid line. The fifth row is a dashed line. The sixth row is a solid line.

Nom _____

Date _____

Colorie la lettre H

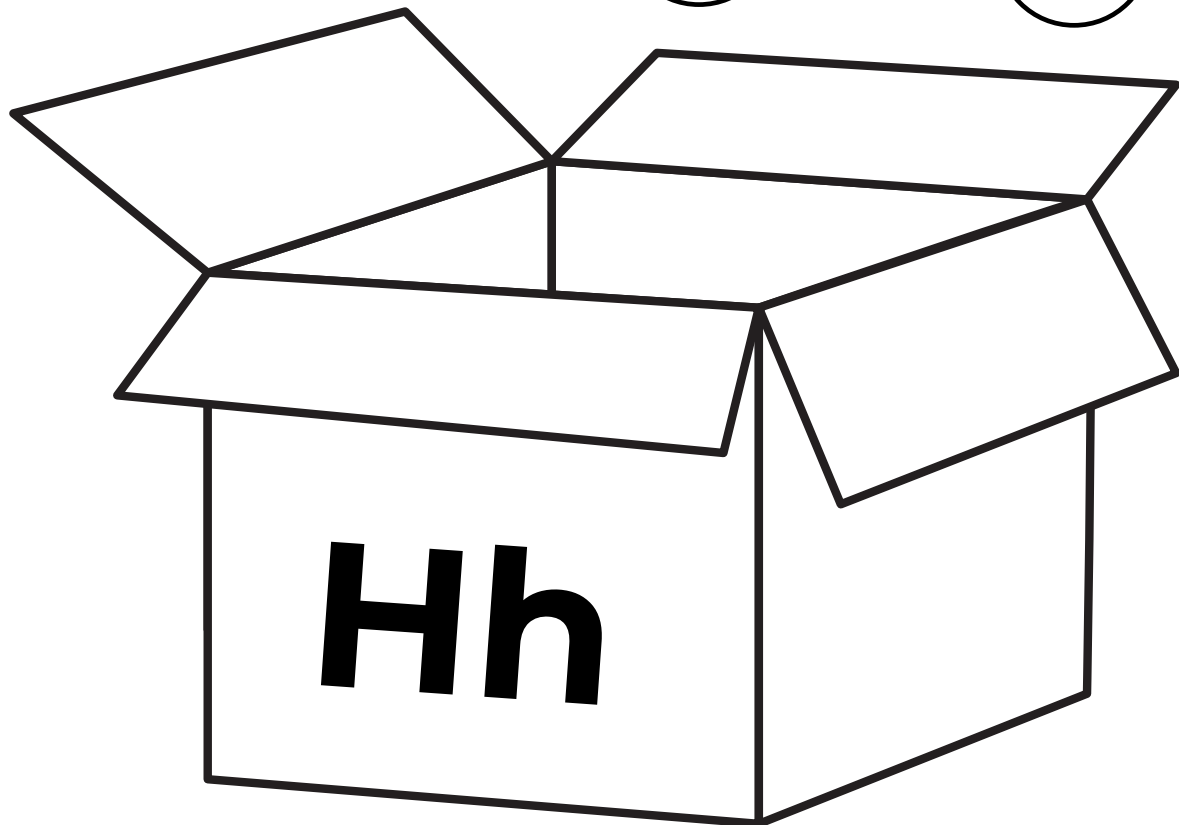
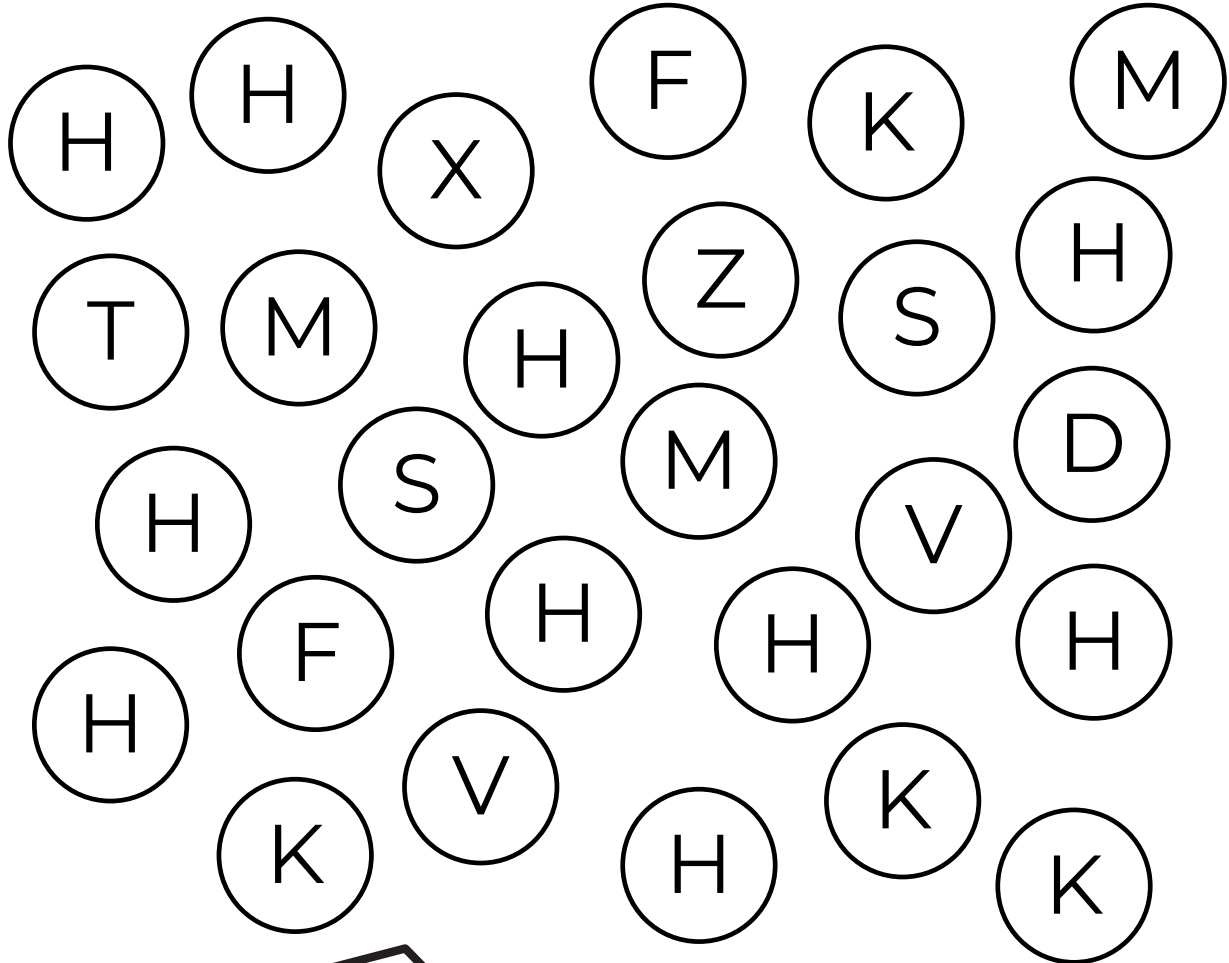

Nom _____

Date _____

Colorie la lettre h

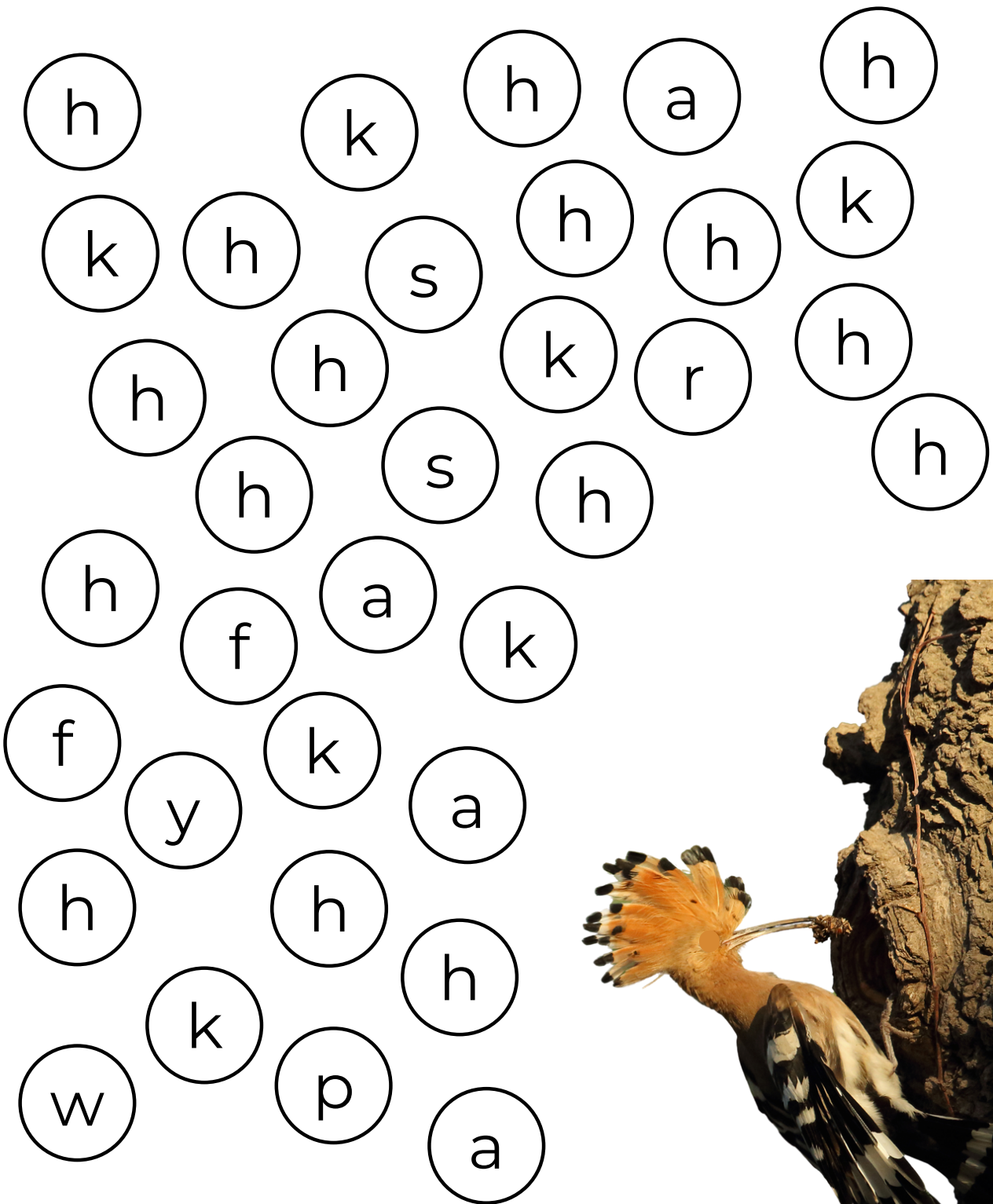

HUPPE / huppe

Nom _____

Date _____

Repasse sur la lettre l / i

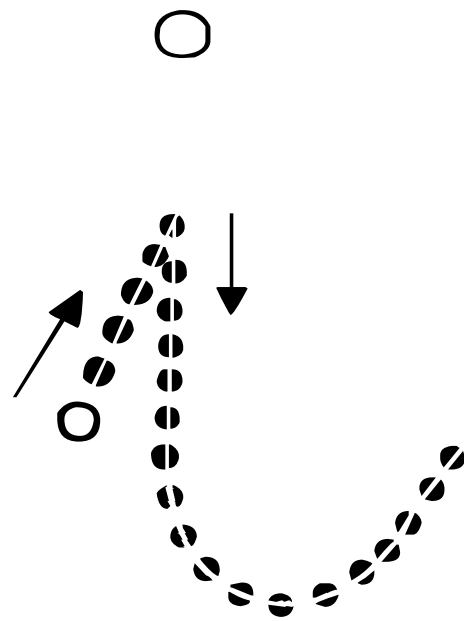

Nom _____

Date _____

Repasse sur la lettre I / i

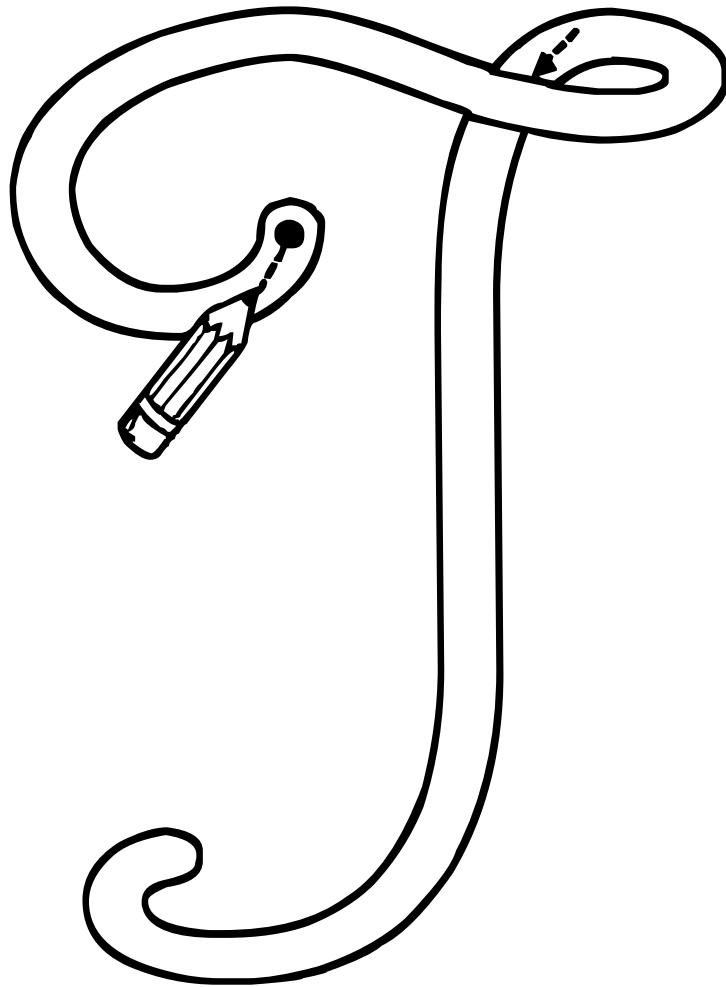

Nom _____

Date _____

Repasse sur la lettre l / i

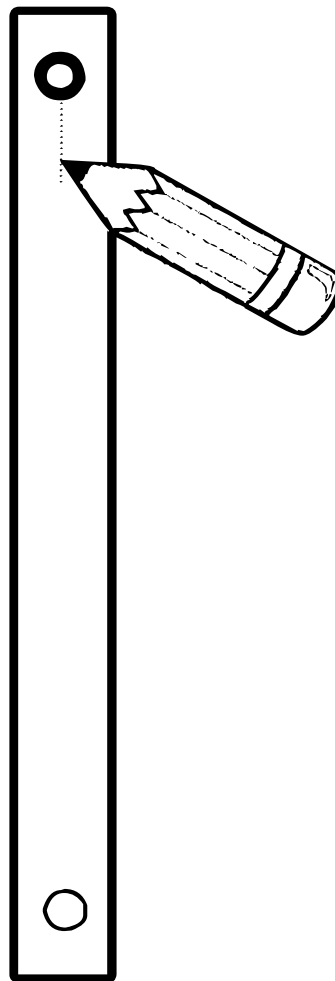

Nom _____

Date _____

Ecris la lettre l / i

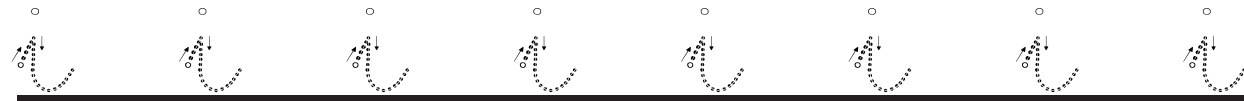

Nom _____

Date _____

Ecris la lettre l / i

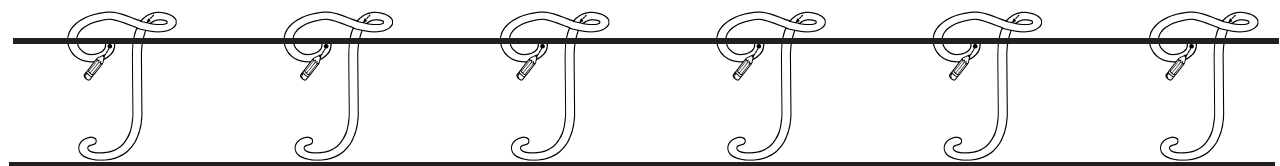
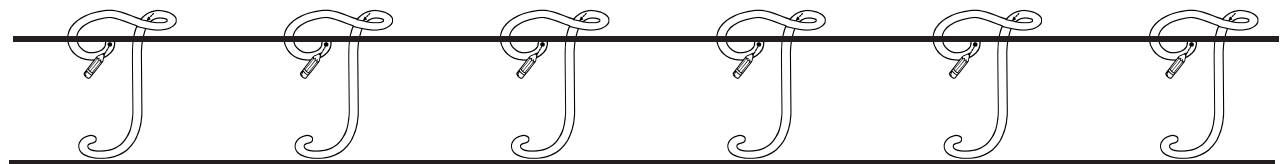
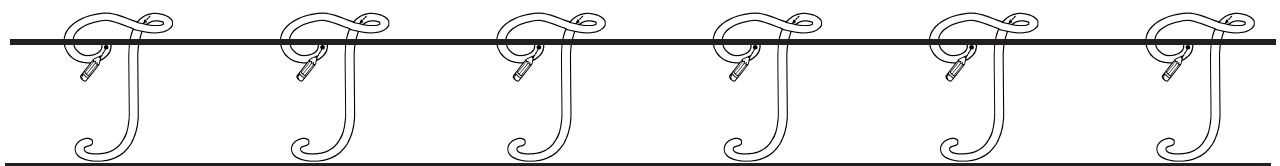
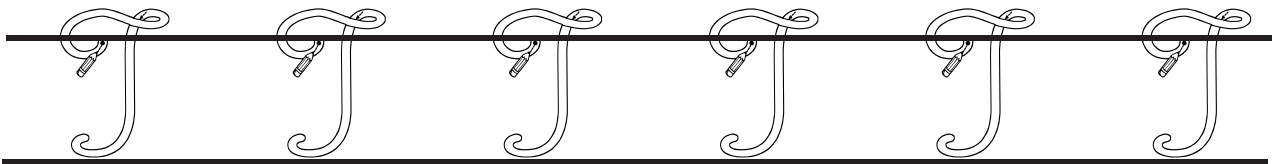
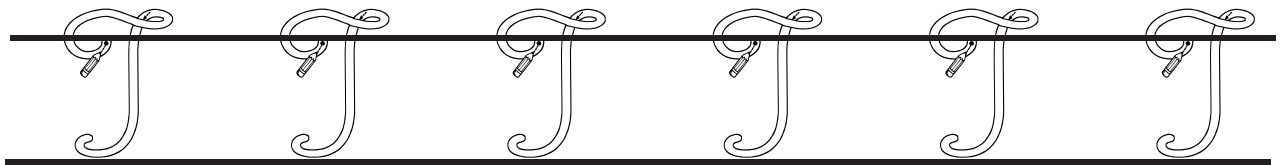
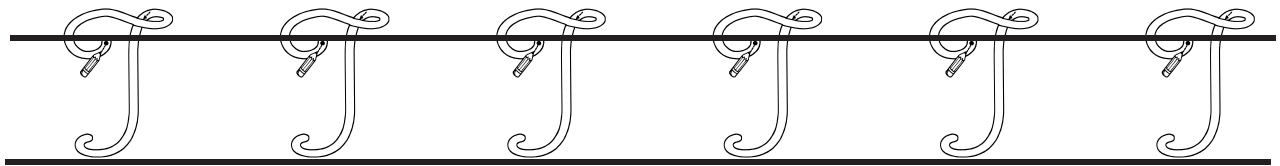
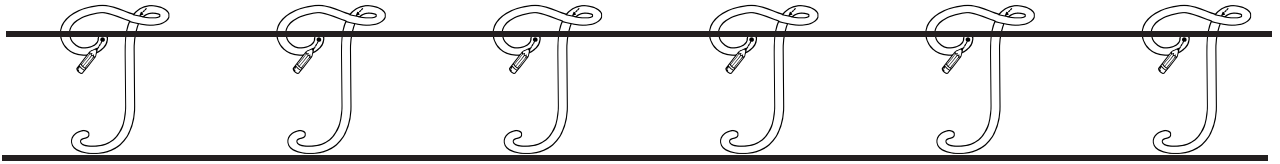

Nom _____ Date _____

Ecris la lettre l/i

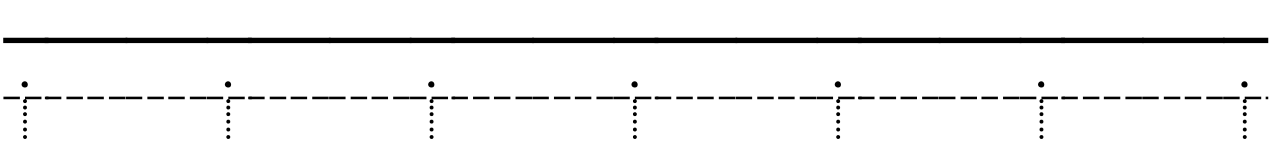
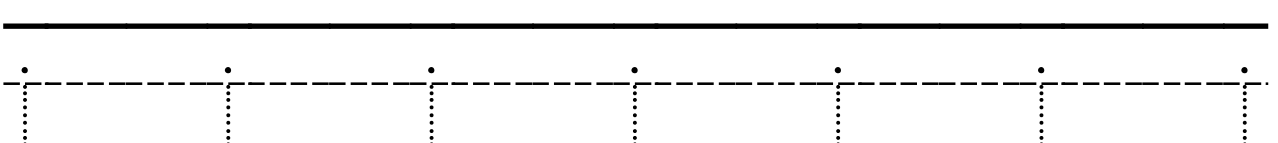
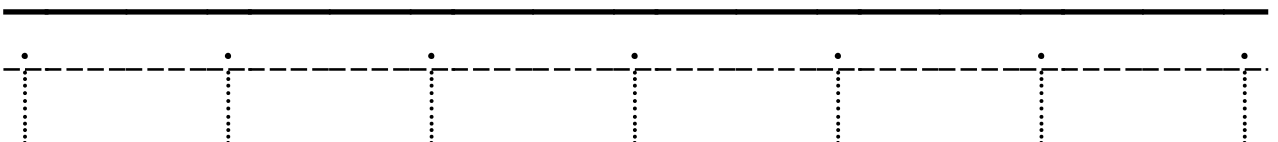
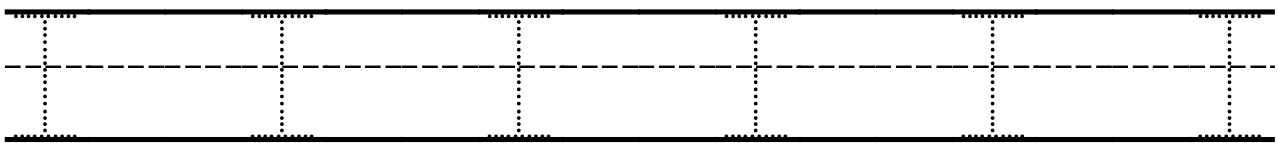
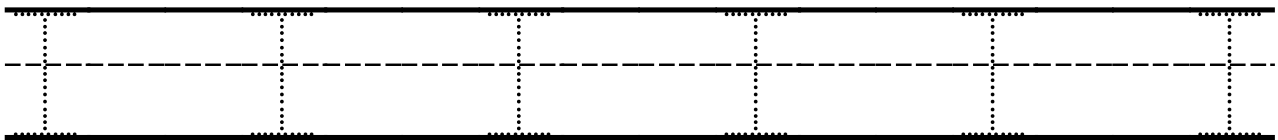
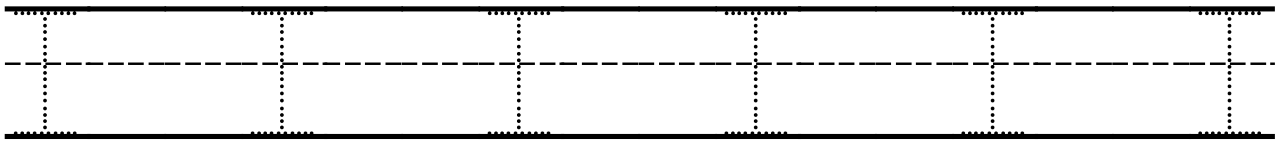

Nom _____ Date _____

Ecris la lettre l/i

l l l l l

i i i i i

Nom _____

Date _____

Colorie la lettre I

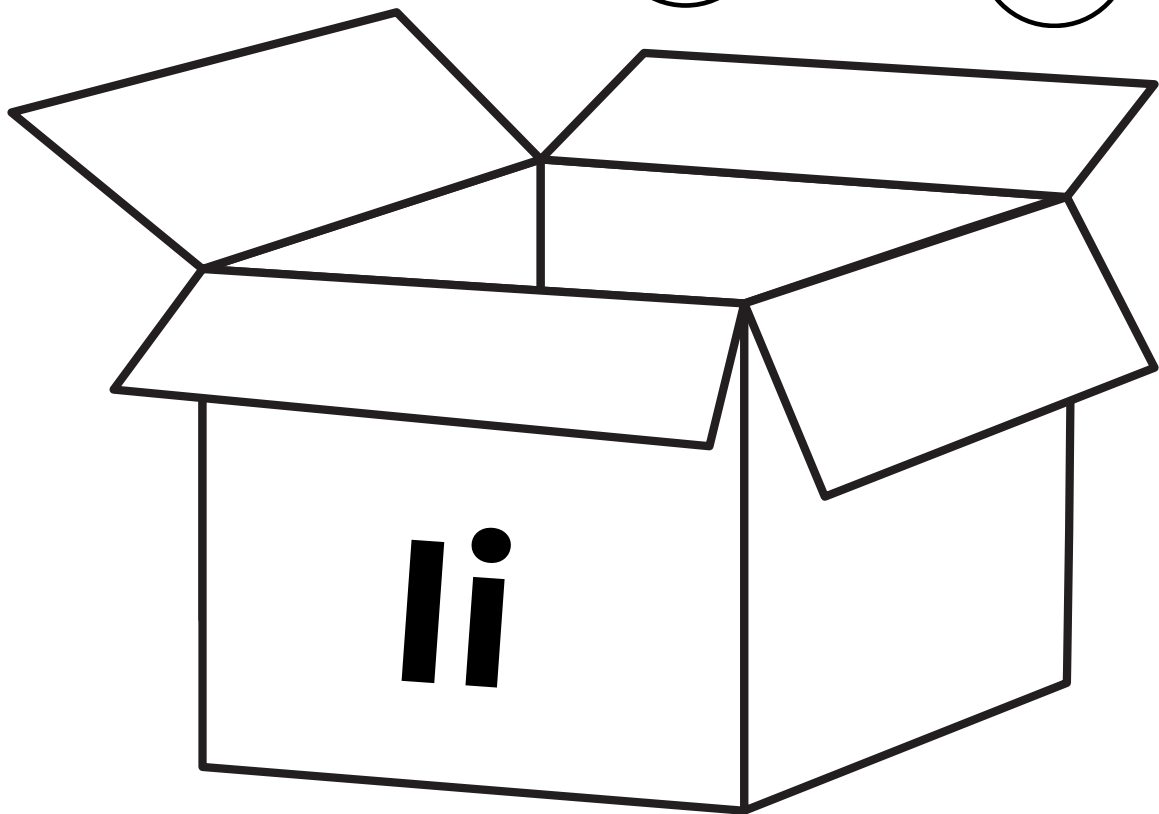
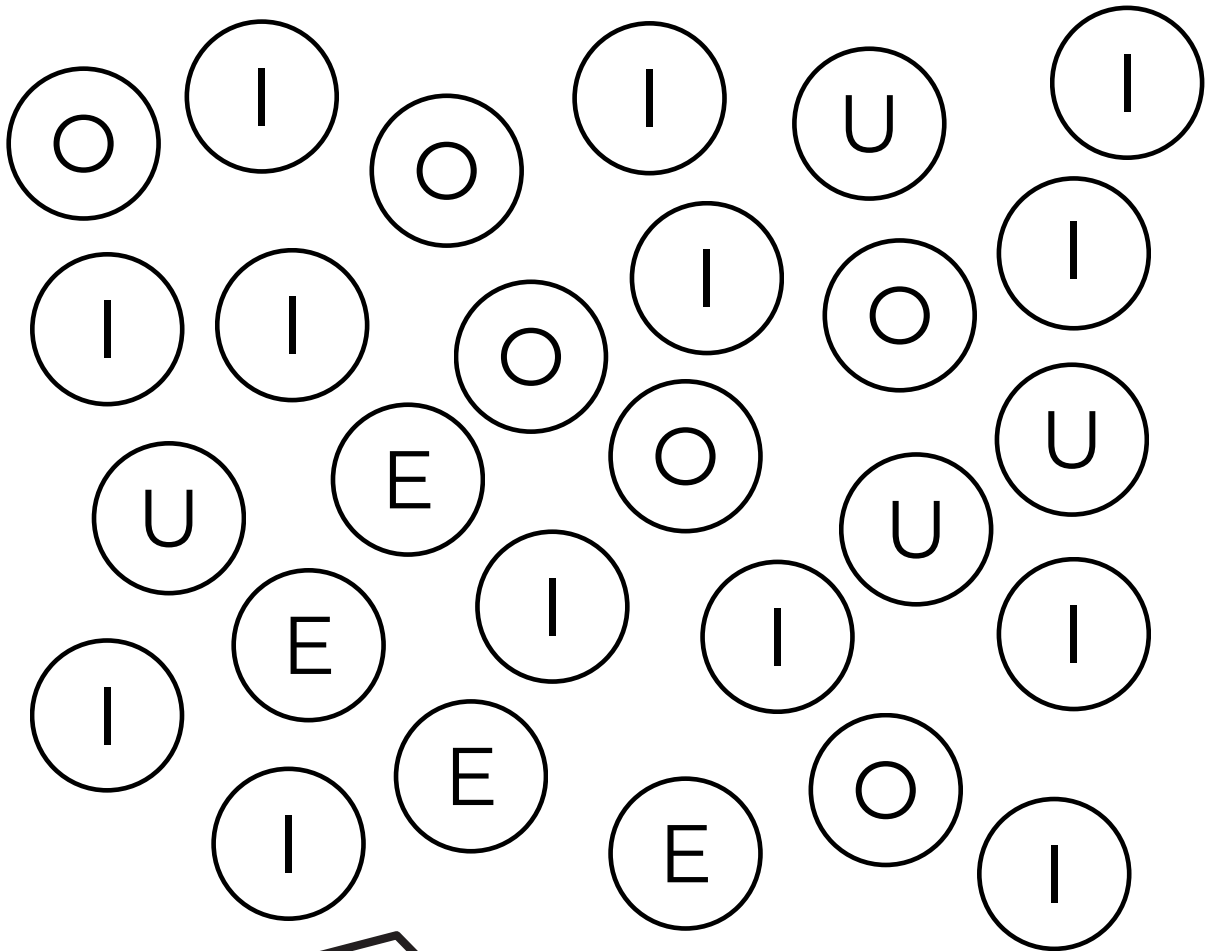

Nom _____

Date _____

Colorie la lettre i

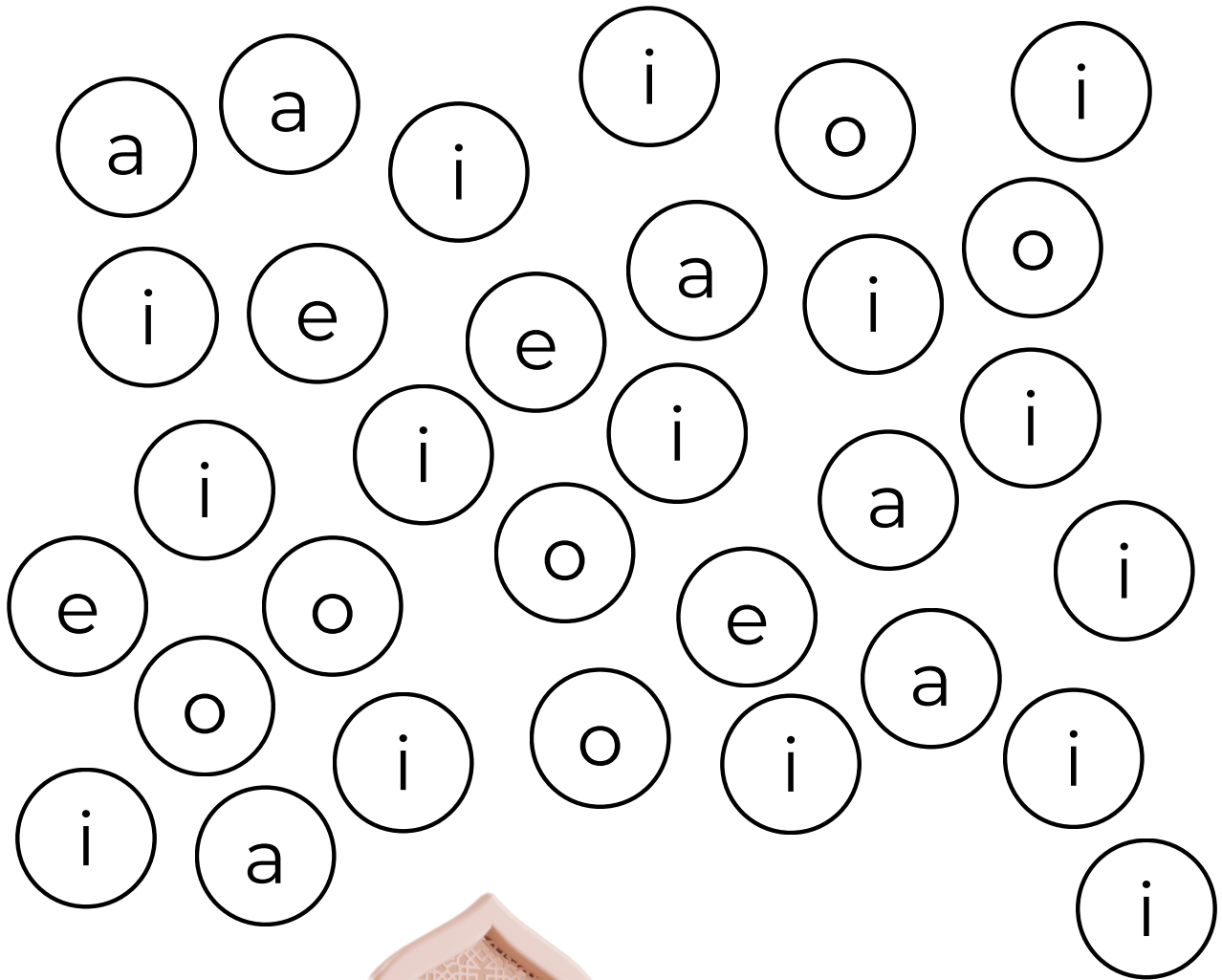

ISLAM / islam

Nom _____

Date _____

Repasse sur la lettre J / j

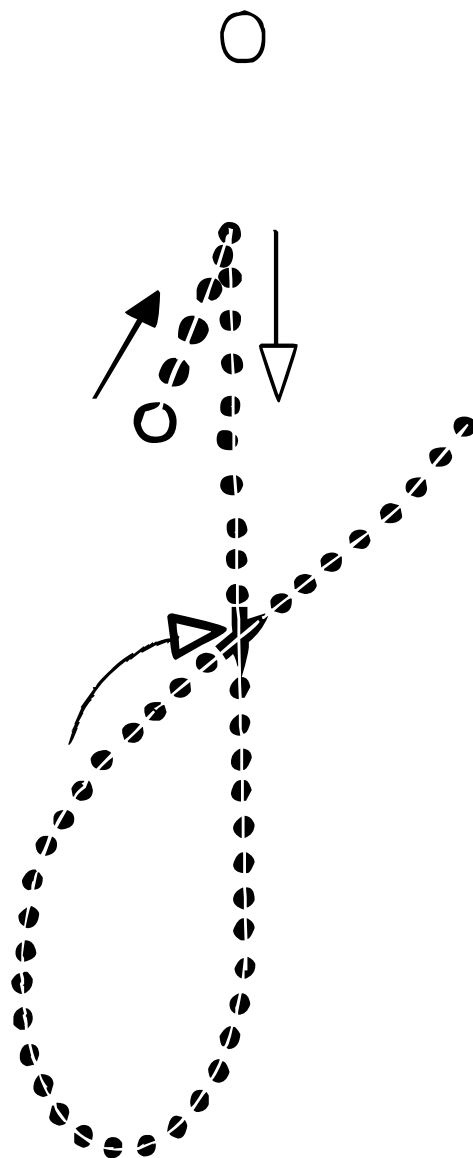

Nom _____

Date _____

Repasse sur la lettre J / j

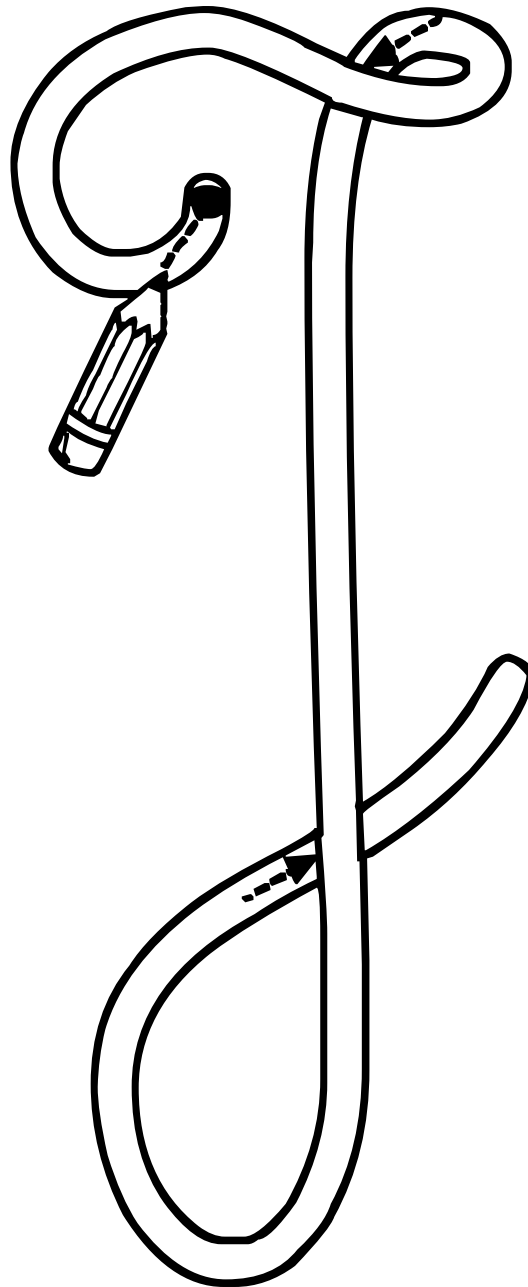

Nom _____

Date _____

Repasse sur la lettre J / j

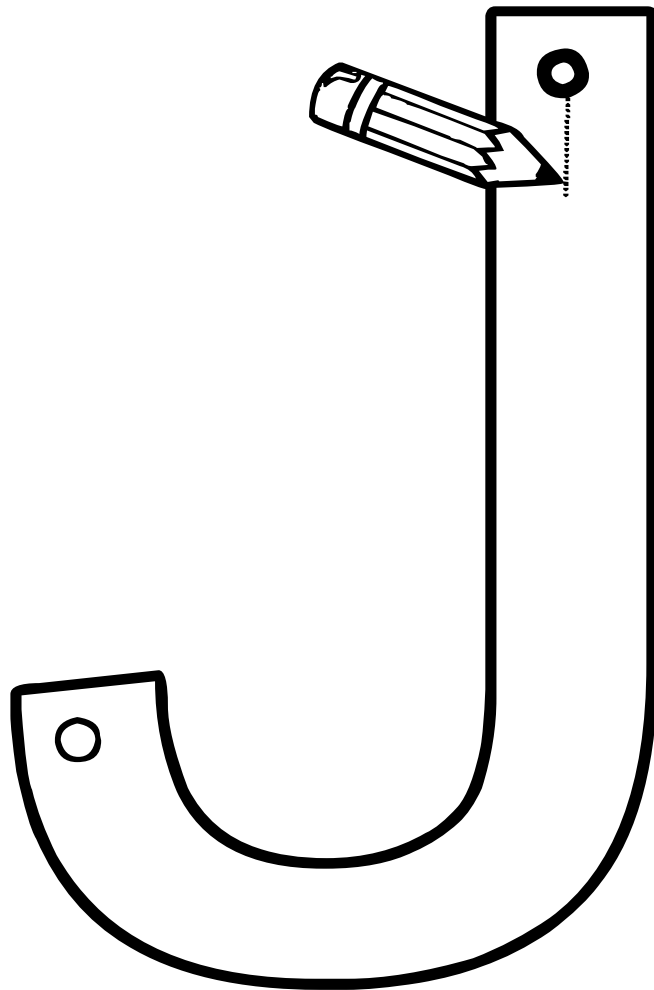

Nom _____

Date _____

Ecris la lettre J / j

Handwriting practice sheet for the letter 'J / j'. The page contains eight rows of handwriting lines. Each row consists of a top line, a middle line, and a bottom line. In each row, there are eight dotted uppercase 'J' characters. Each 'J' has a small circle above it and a dashed arrow indicating the starting point and direction of the stroke. The first row is followed by a blank line, and the second row is followed by a blank line, creating a total of ten rows for practice.

Nom _____

Date _____

Ecris la lettre J / j

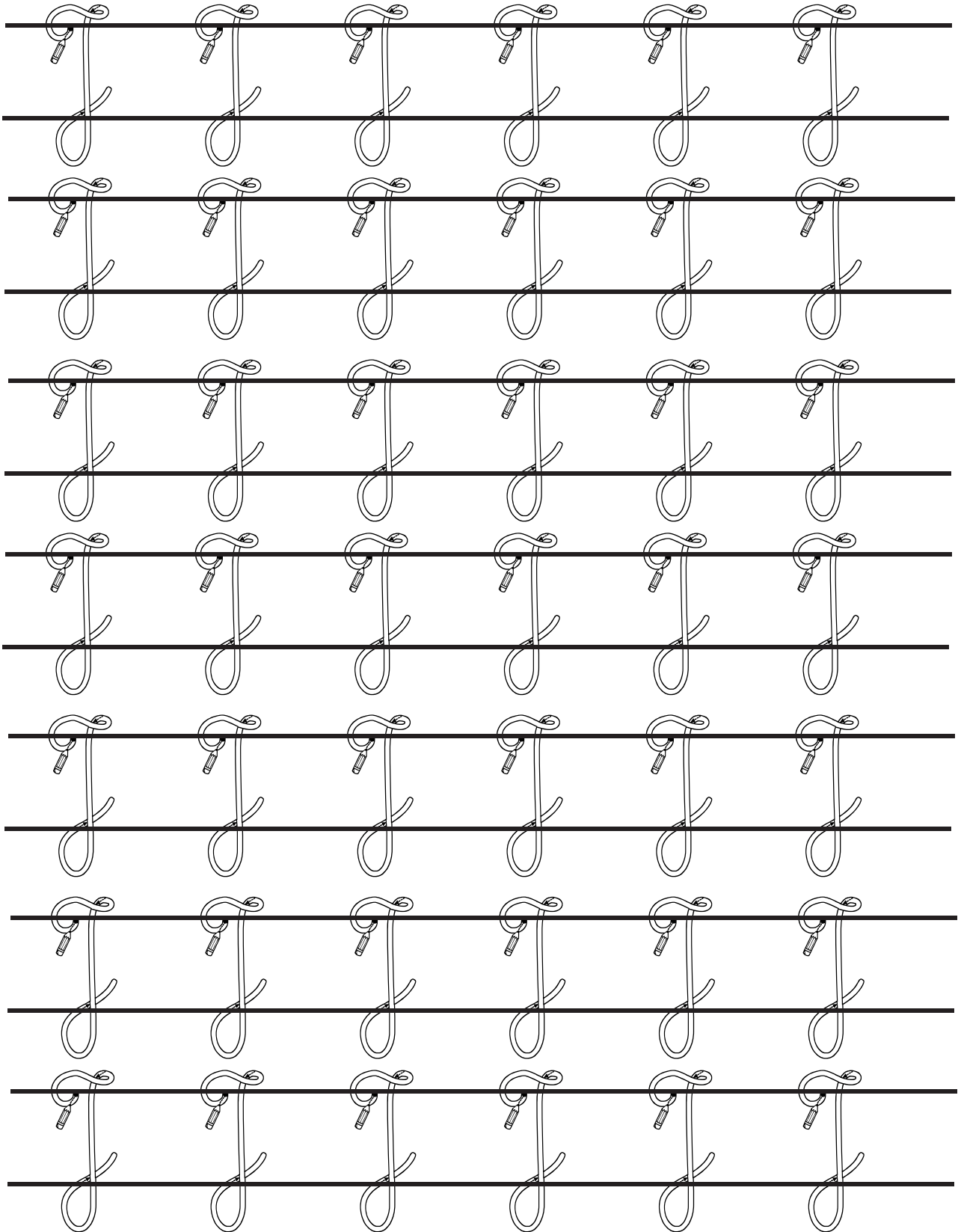

Nom _____

Date _____

Ecris la lettre J/j

J J J J J

J J J J J

J J J J J

J J J J J

j j j j j j j

j j j j j j j

j j j j j j j

j j j j j j j

Nom _____ Date _____

Ecris la lettre J/j

J J J J J

Handwriting practice lines for uppercase letter J. The first line is a solid top line. The second line is a dashed midline. The third line is a solid bottom line. Below this set, there is another identical set of three lines (solid top, dashed midline, solid bottom) for further practice.

j j j j j

Handwriting practice lines for lowercase letter j. The first line is a solid top line. The second line is a dashed midline. The third line is a solid bottom line. Below this set, there is another identical set of three lines (solid top, dashed midline, solid bottom) for further practice.

Nom _____ Date _____

Colorie la lettre J

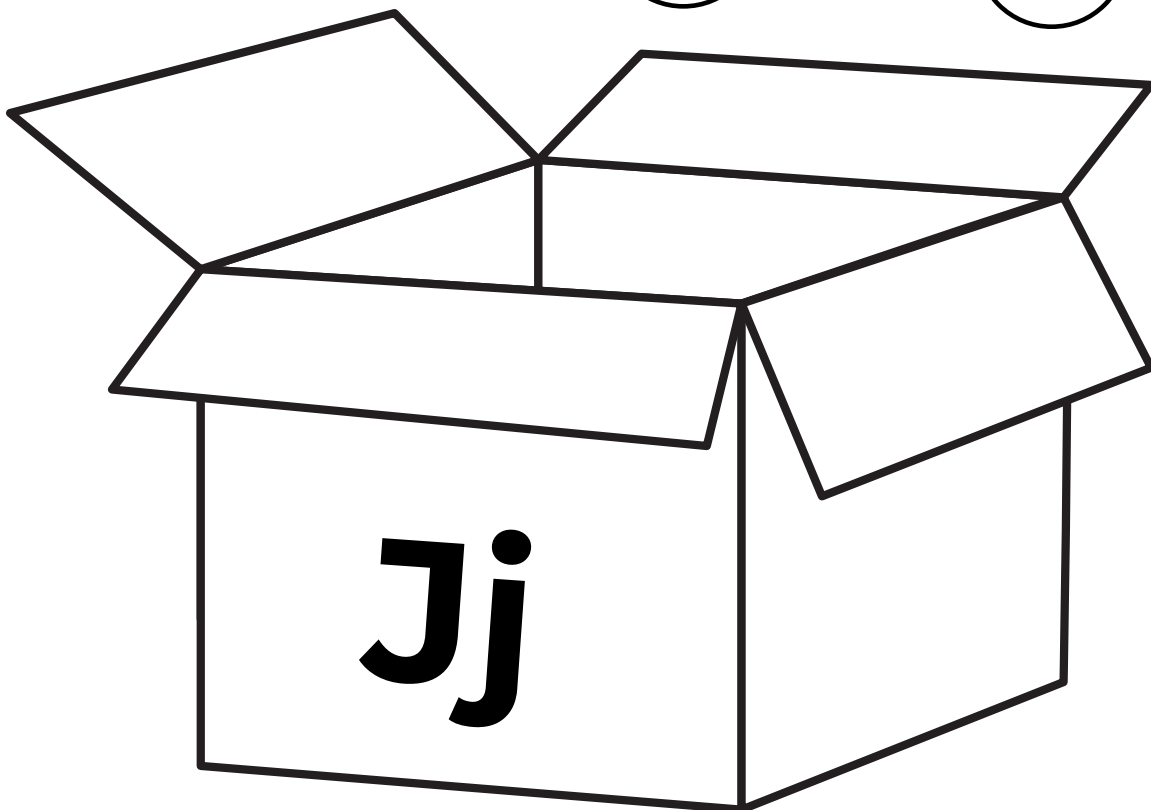
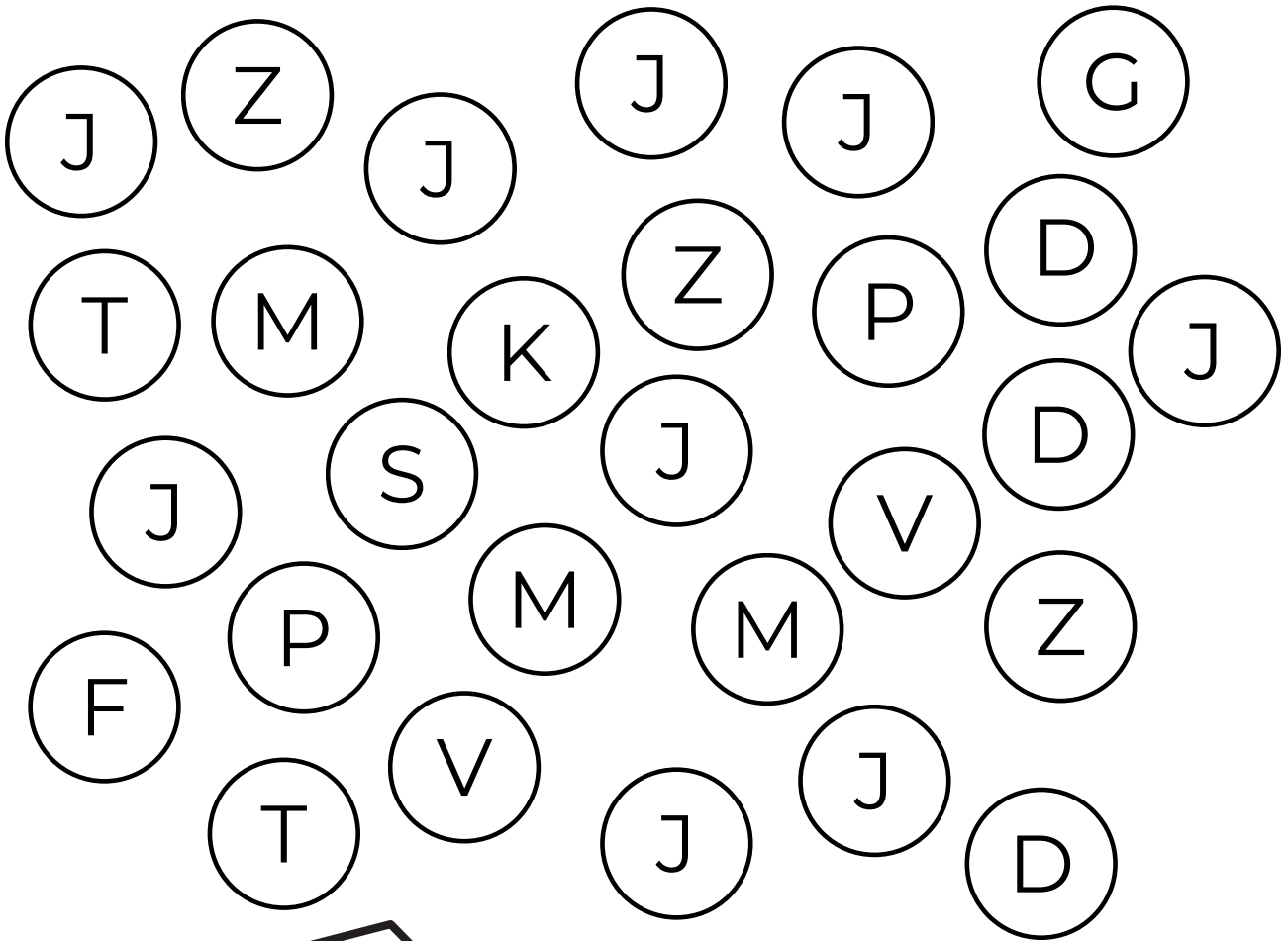

Nom _____

Date _____

Colorie la lettre j

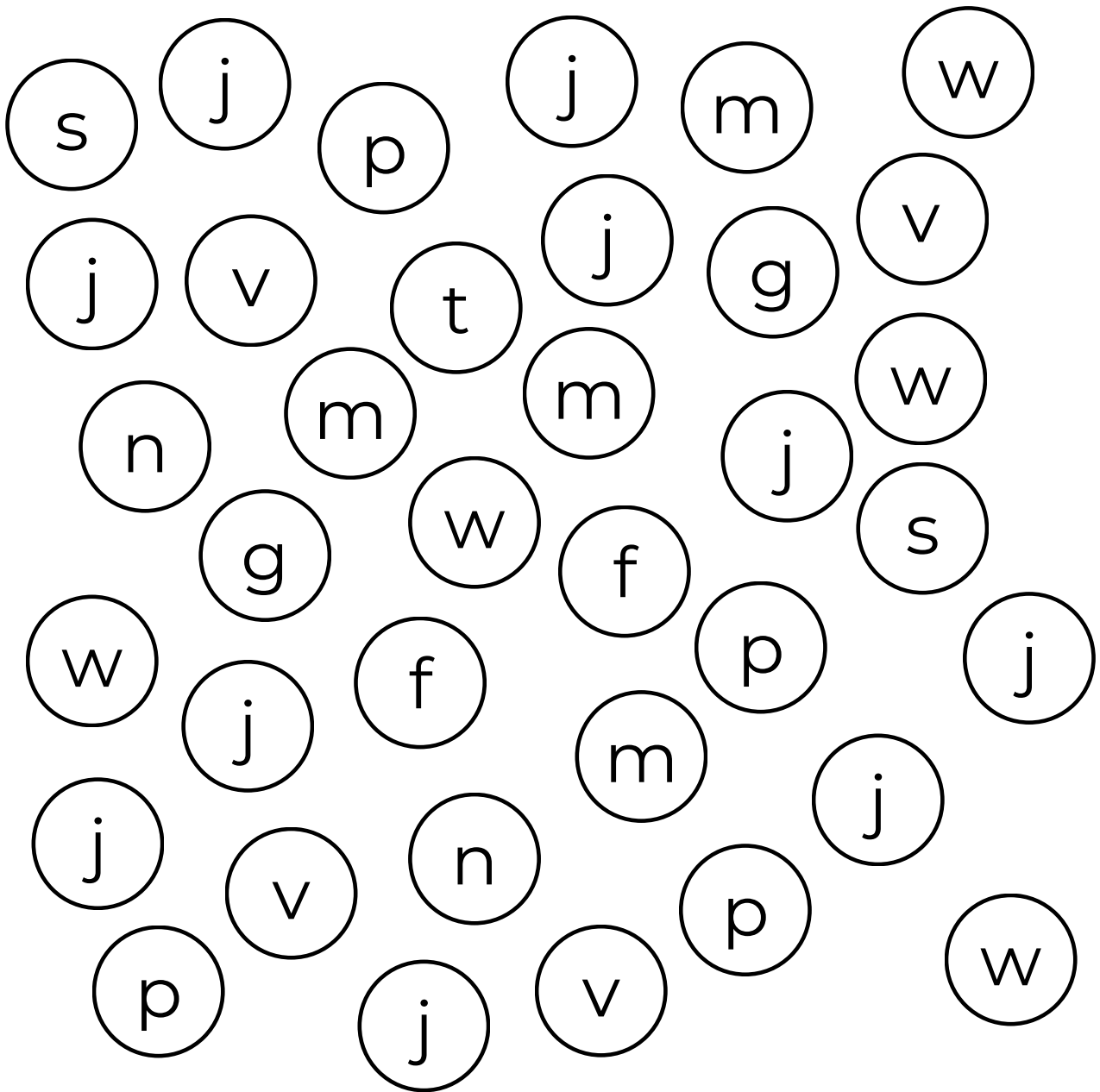

JARDIN / jardin



Nom _____

Date _____

Repasse sur la lettre K / k

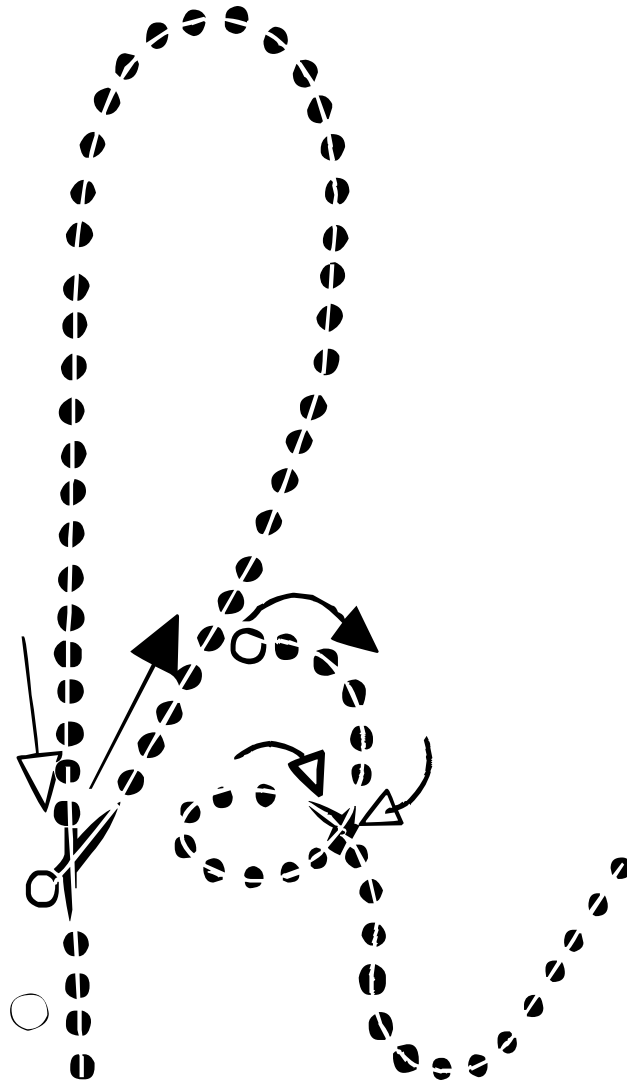

Nom _____

Date _____

Repasse sur la lettre K / k

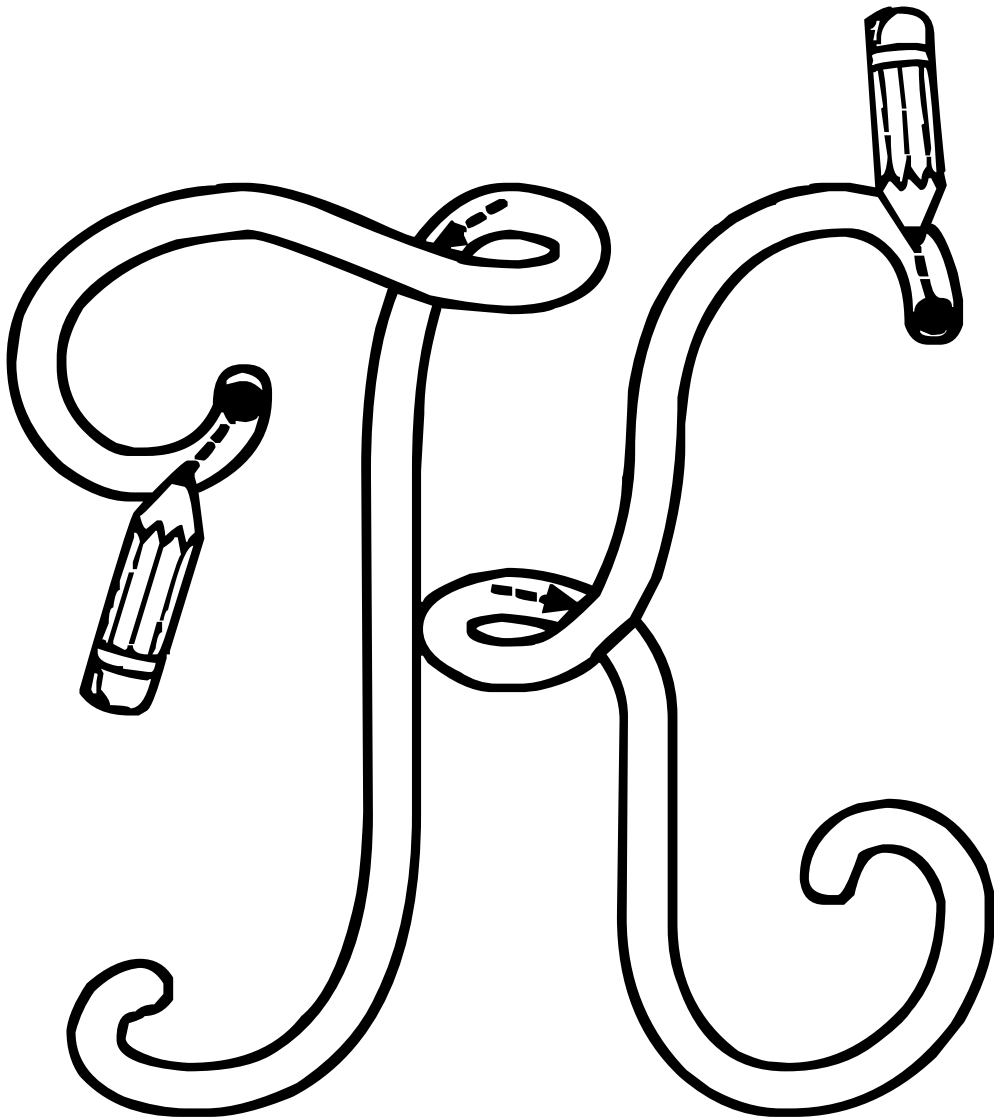

Nom _____

Date _____

Repasse sur la lettre K / k

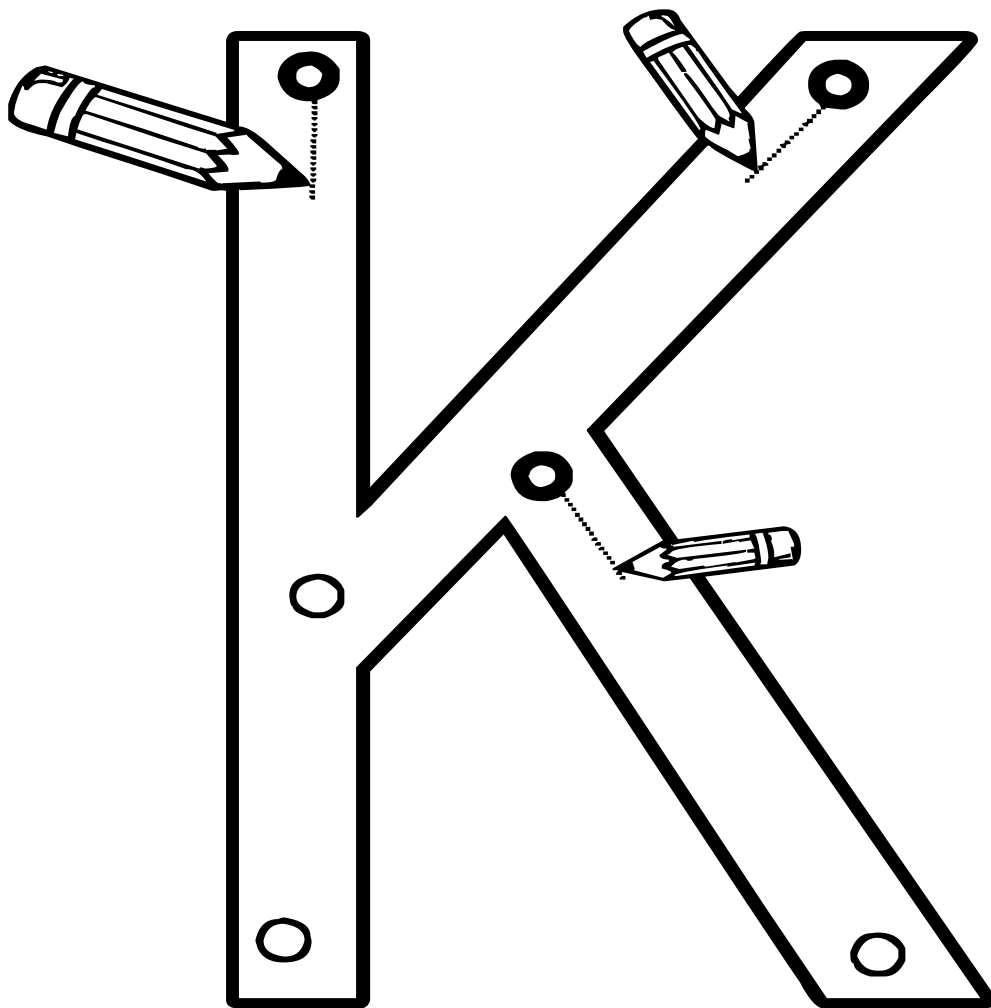

Nom _____

Date _____

Ecris la lettre K / k

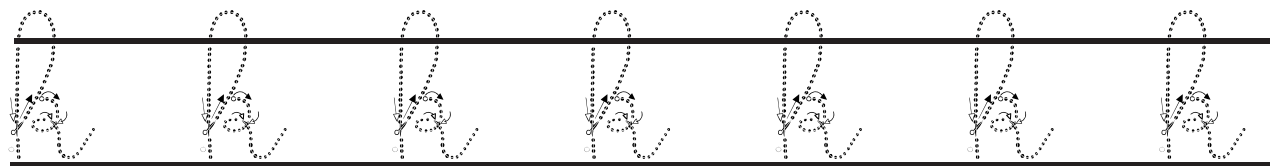
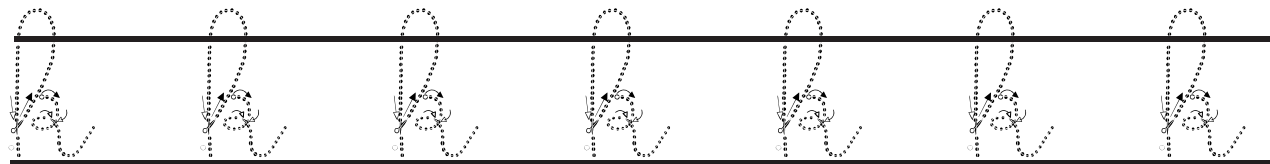
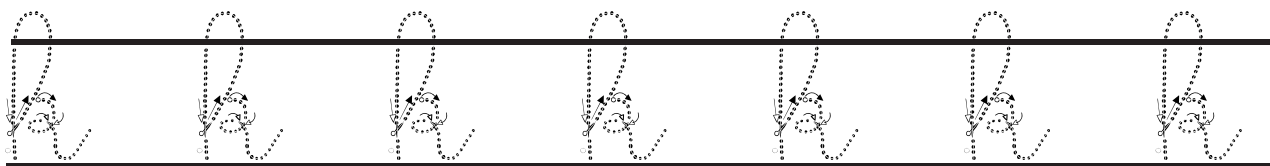
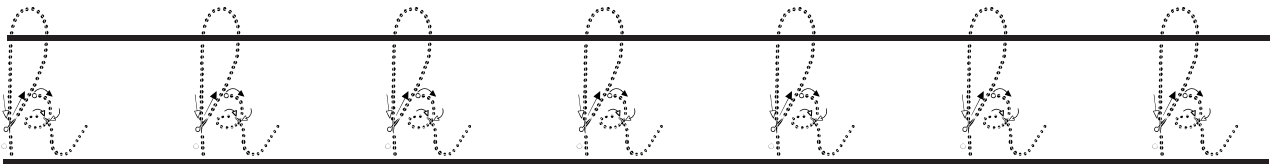
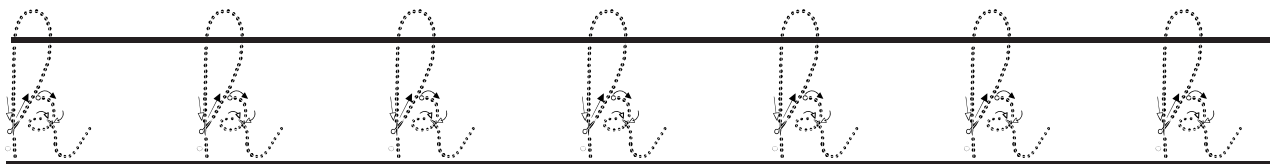
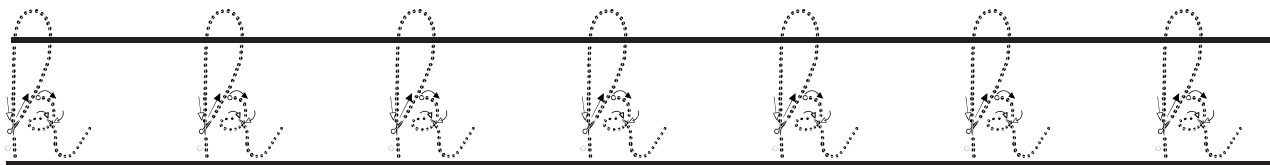
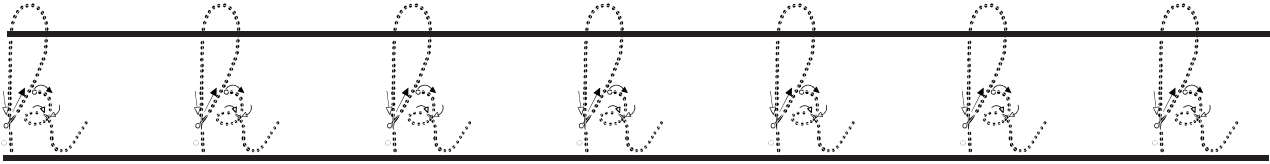

Nom _____

Date _____

Ecris la lettre K / k

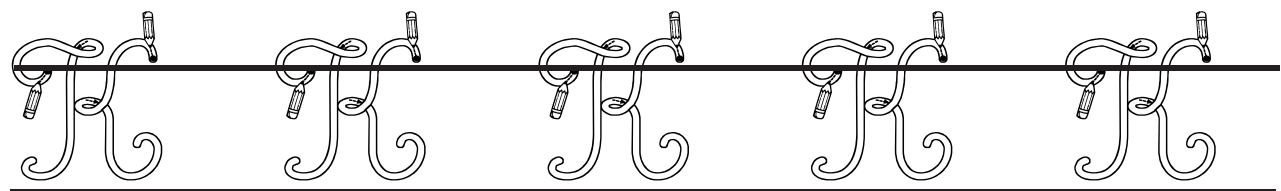
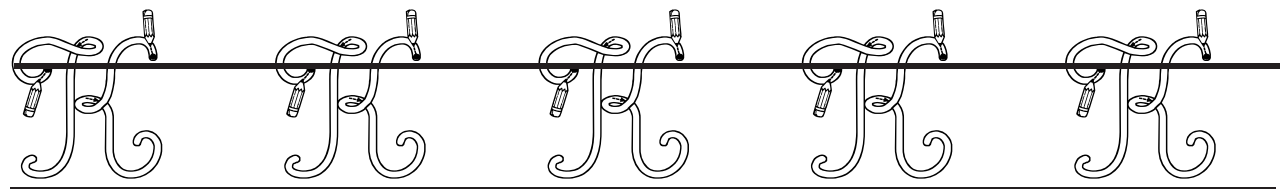
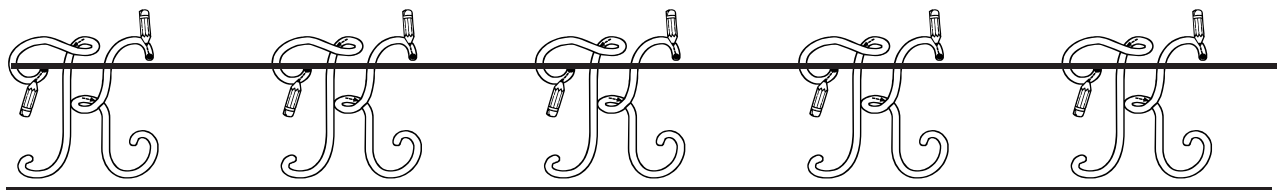
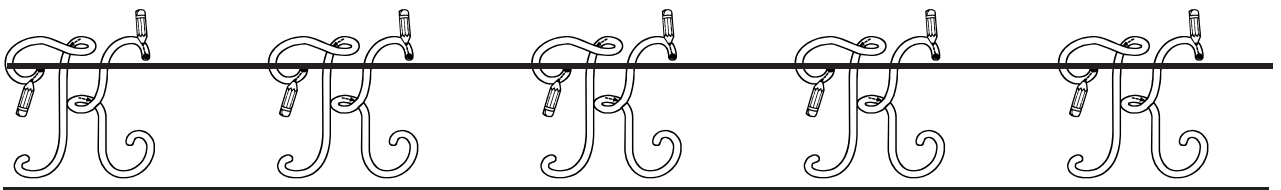
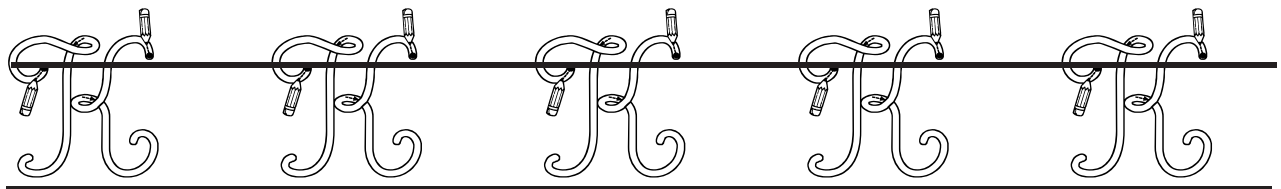
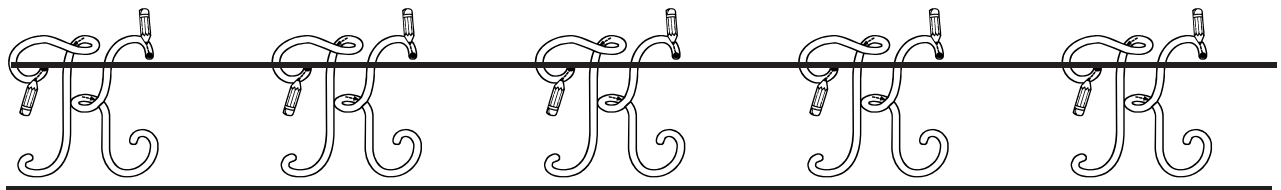
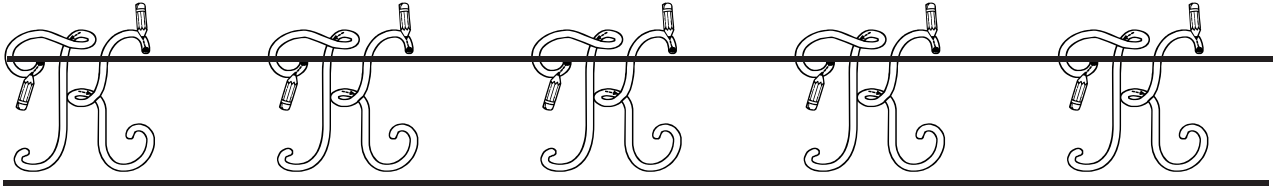

Nom _____

Date _____

Ecris la lettre K/k

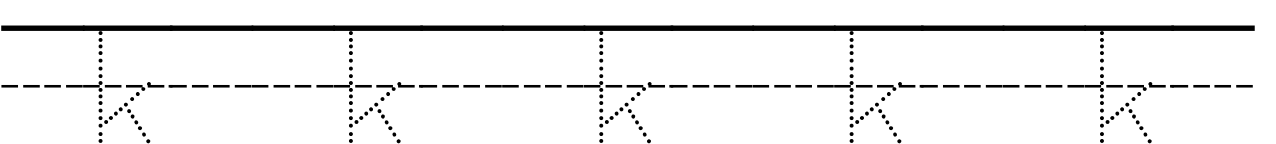
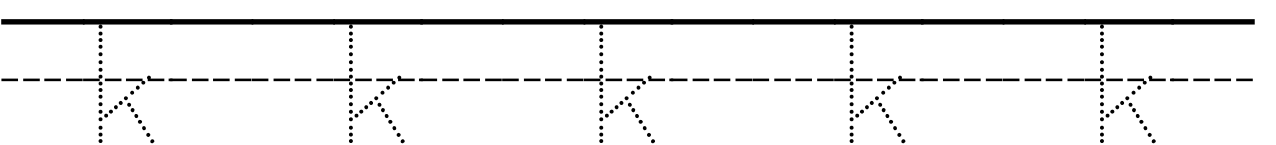
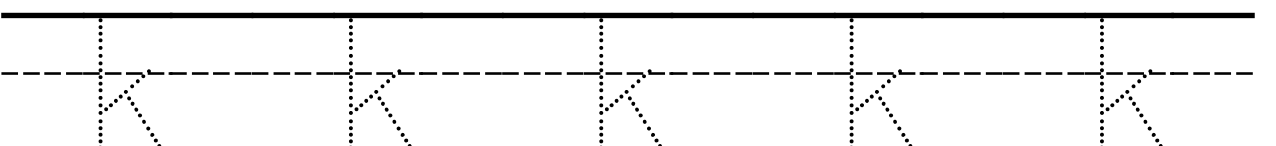
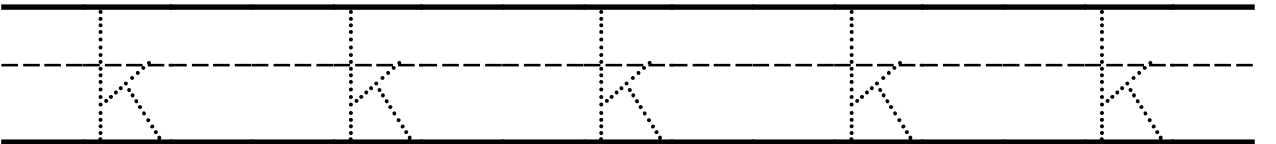
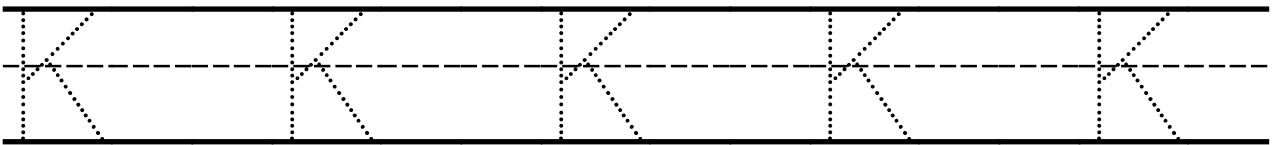
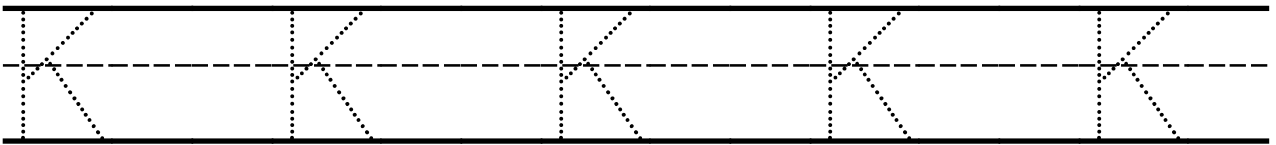
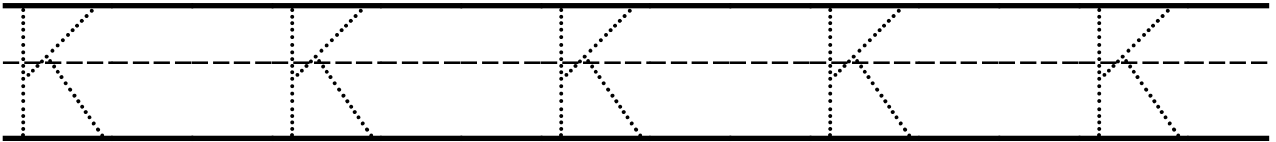
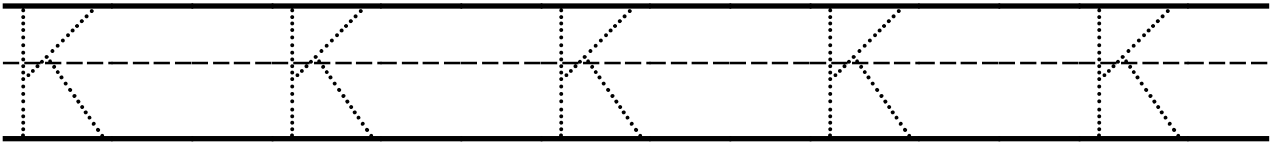

Nom _____ Date _____

Ecris la lettre K/k

K K K K K

Handwriting practice lines for uppercase letter K. Each set consists of a solid top line, a dashed middle line, and a solid bottom line. There are two such sets of lines provided for practice.

k k k k k

Handwriting practice lines for lowercase letter k. Each set consists of a solid top line, a dashed middle line, and a solid bottom line. There are two such sets of lines provided for practice.

Nom _____

Date _____

Colorie la lettre K

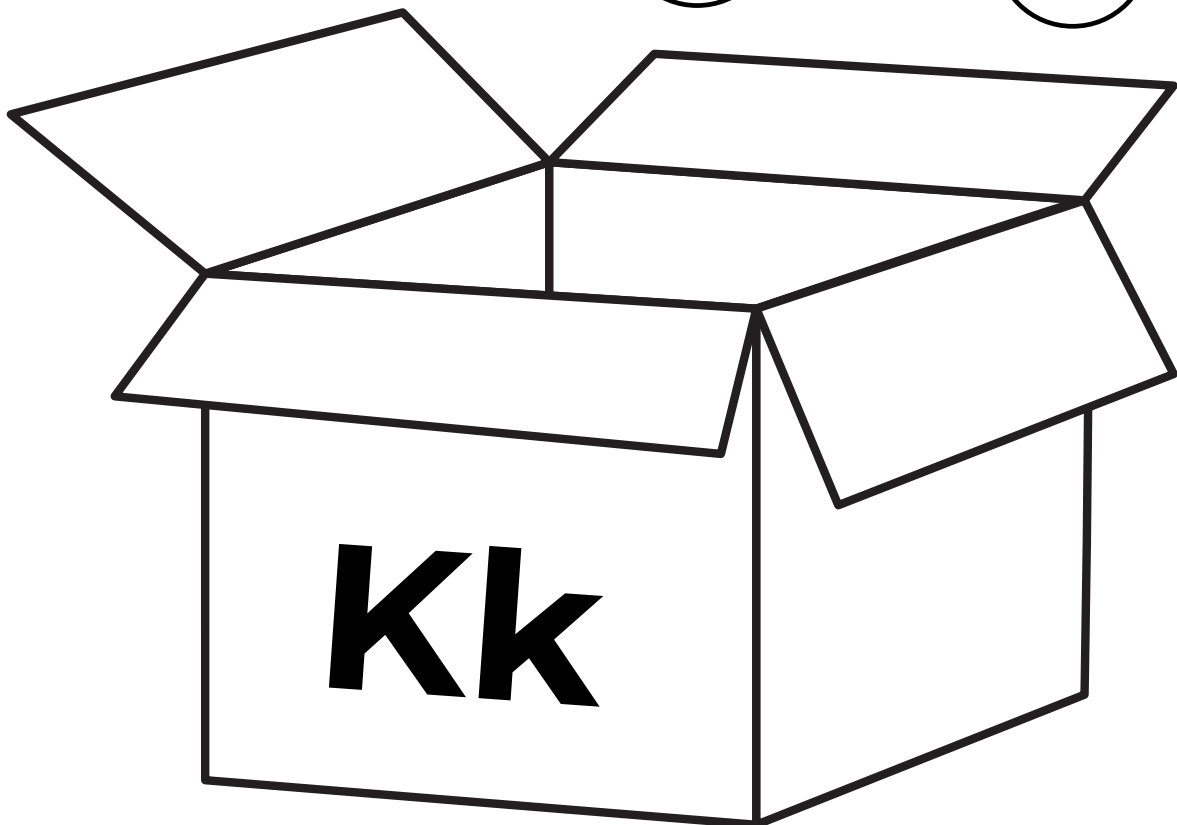
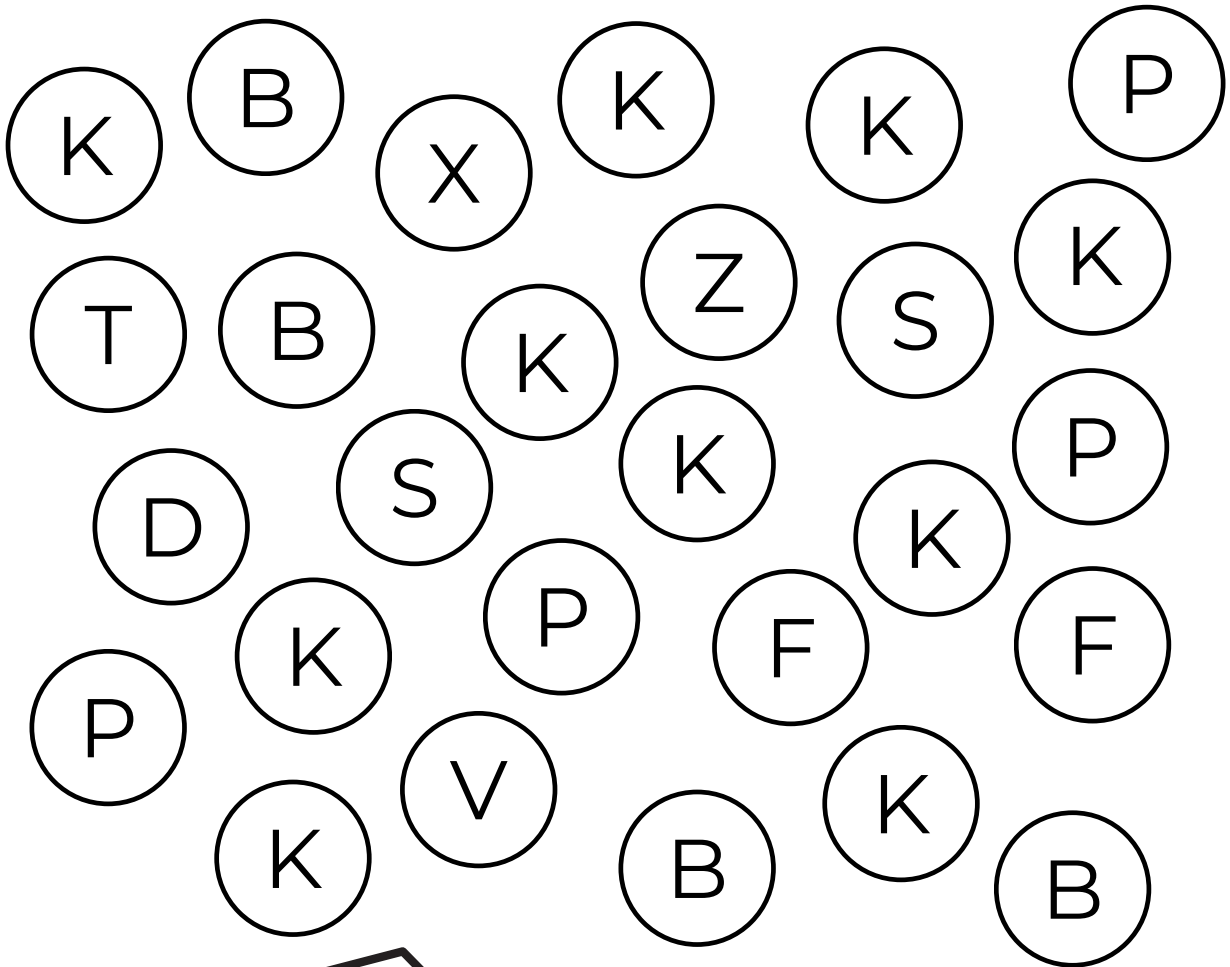

Nom _____

Date _____

Colorie la lettre k

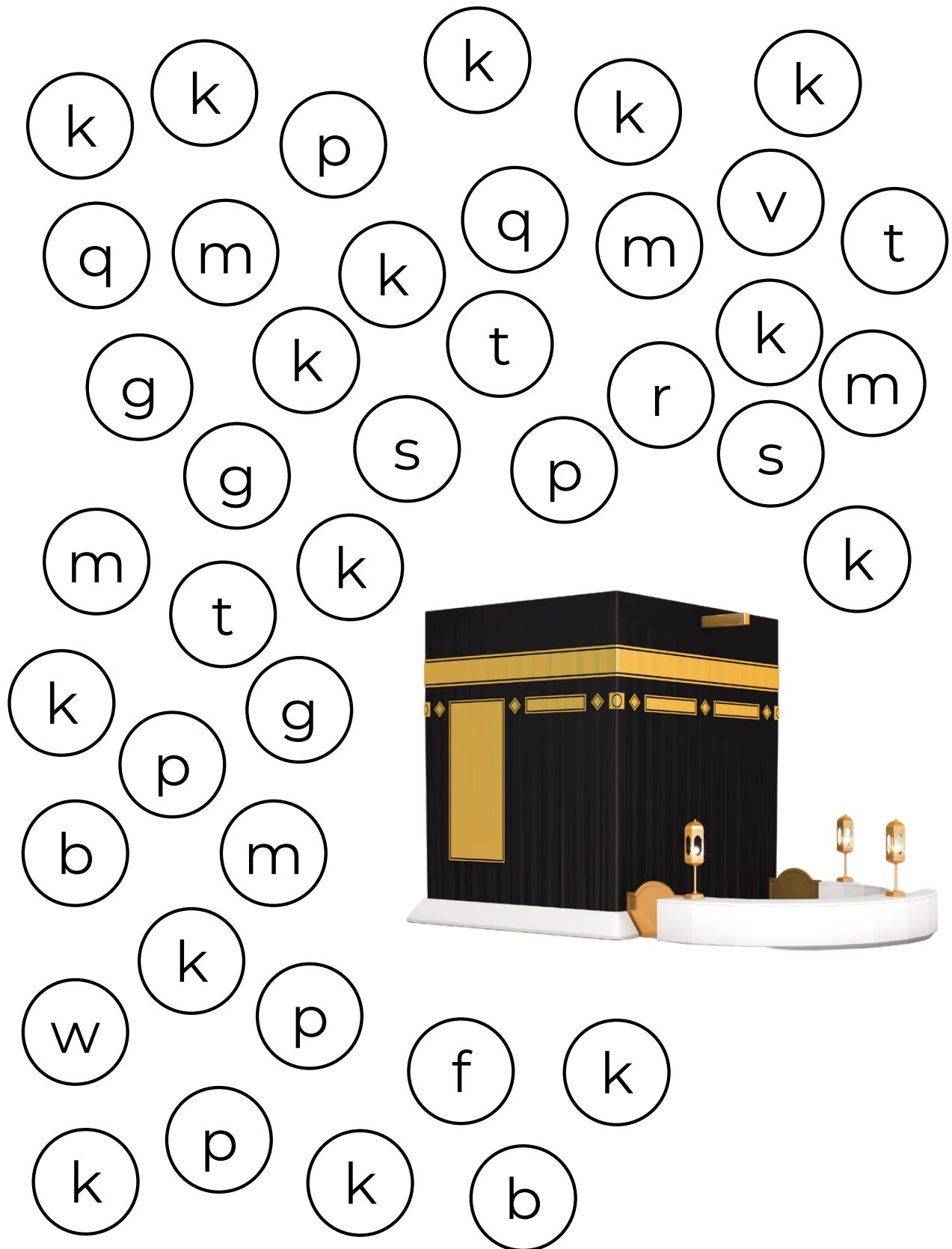

KAABA / kaaba

Nom _____

Date _____

Repasse sur la lettre L / l

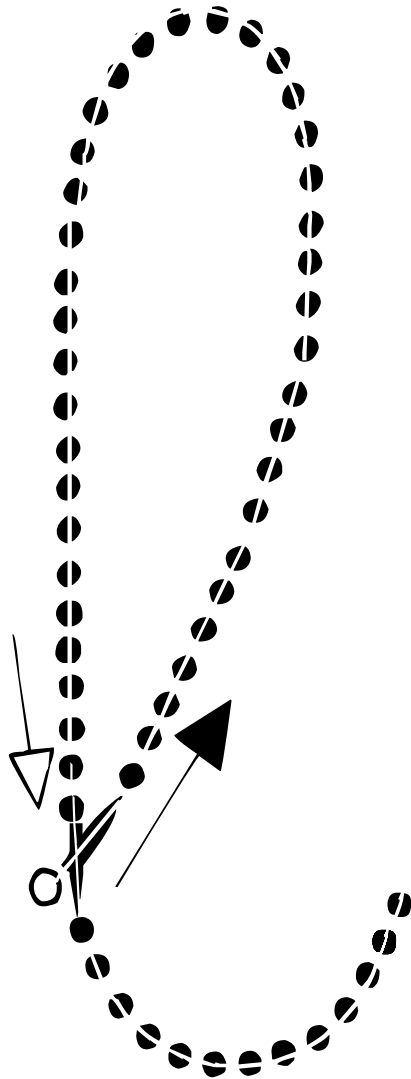

Nom _____

Date _____

Repasse sur la lettre L / l

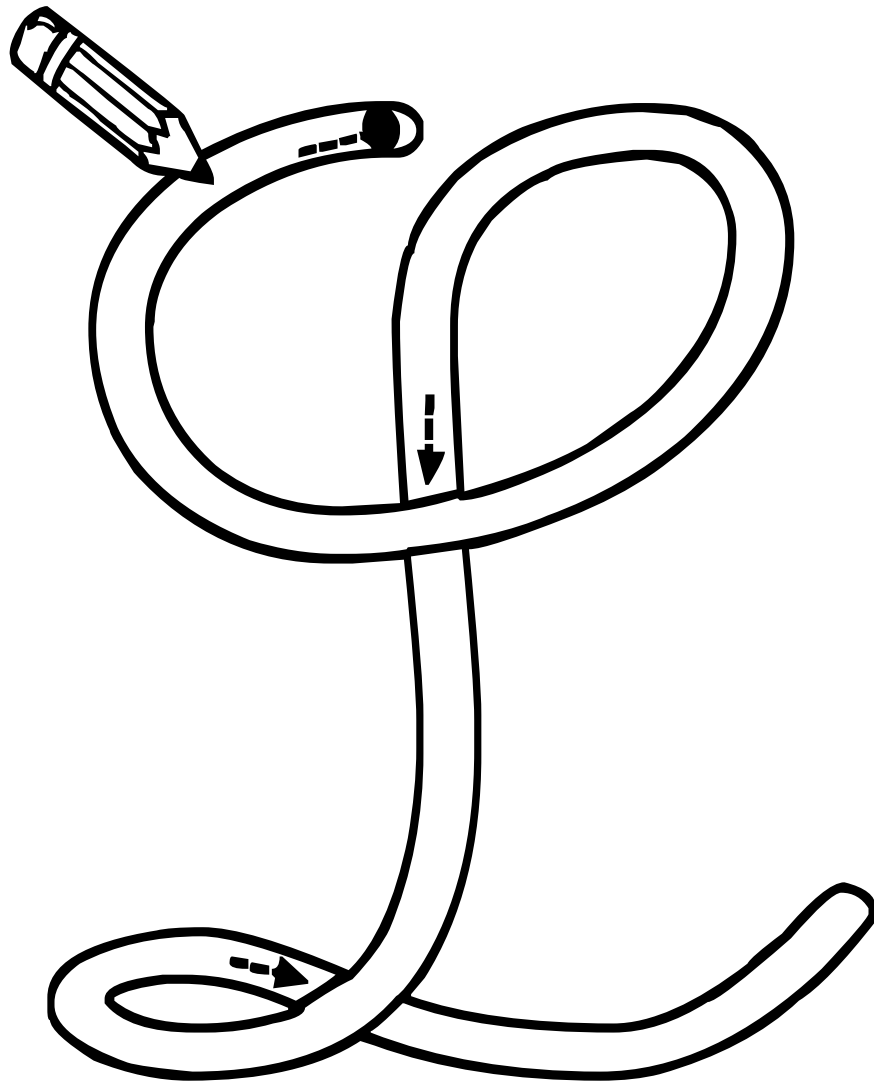

Nom _____

Date _____

Repasse sur la lettre L / l

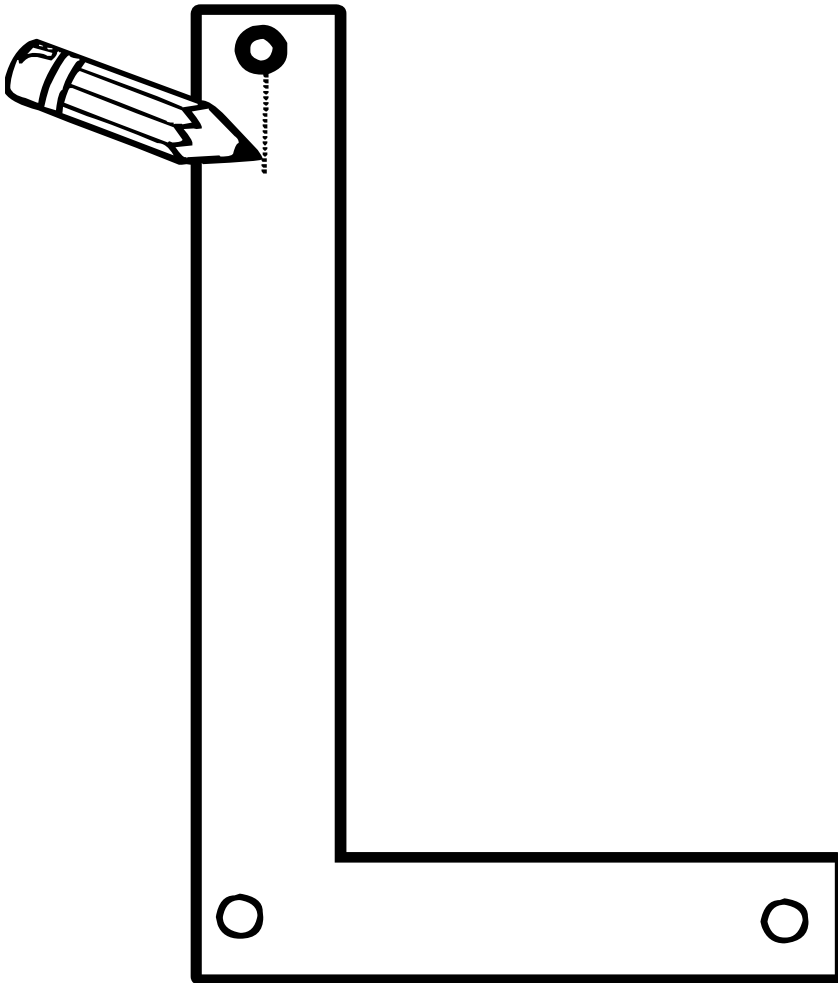

Nom _____

Date _____

Ecris la lettre L / l

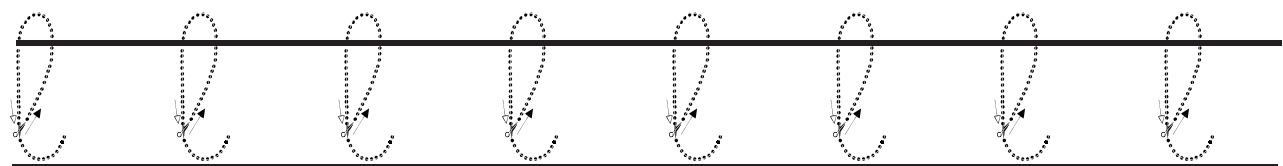
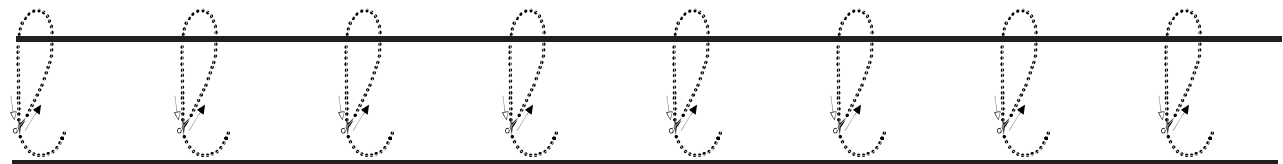
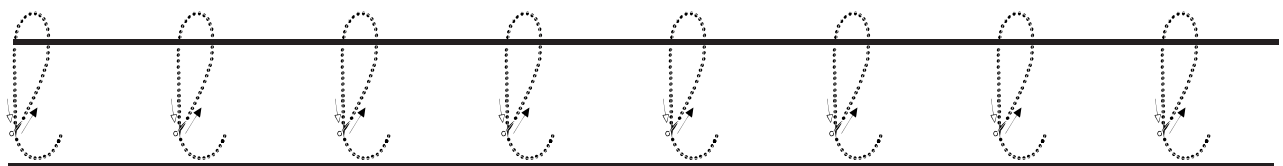
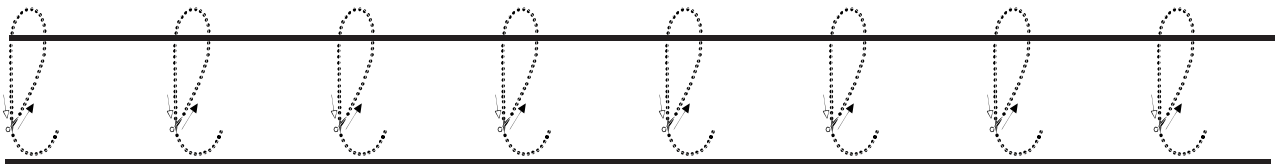
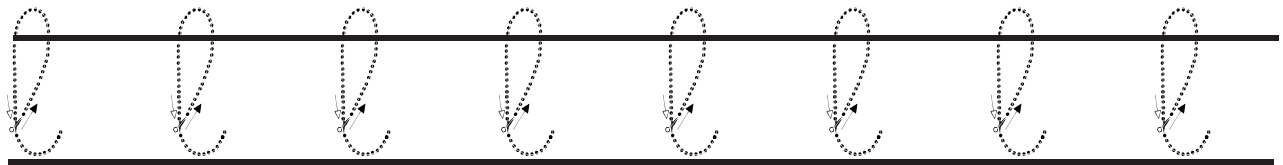
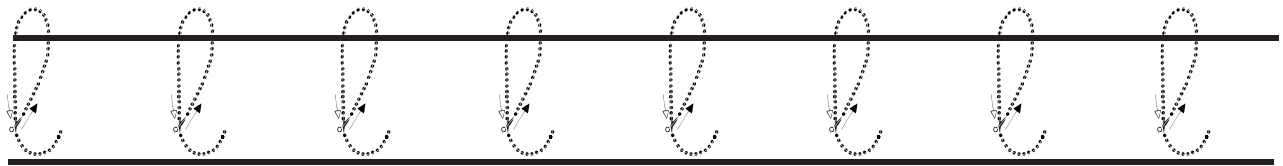
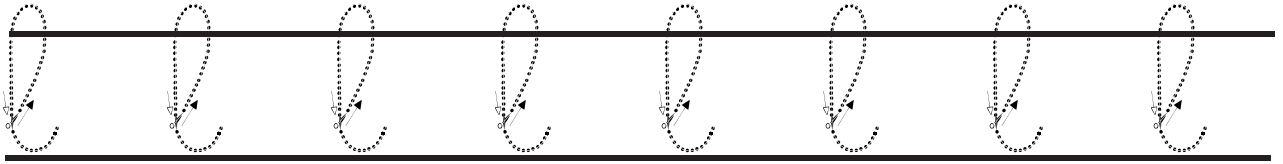

Nom _____

Date _____

Ecris la lettre L / l

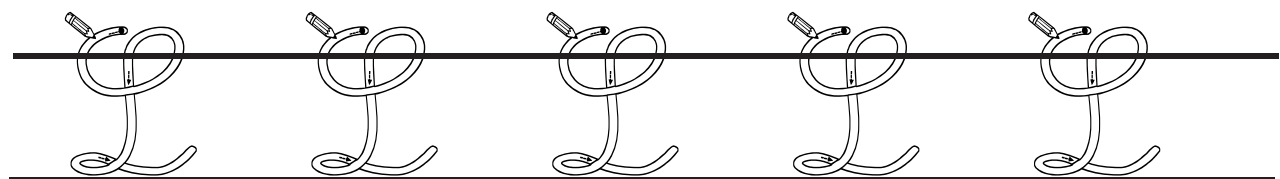
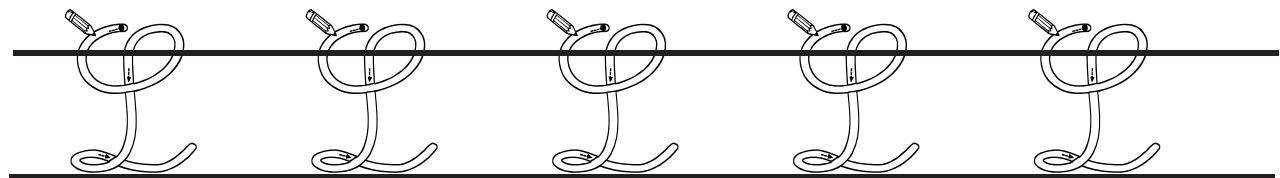
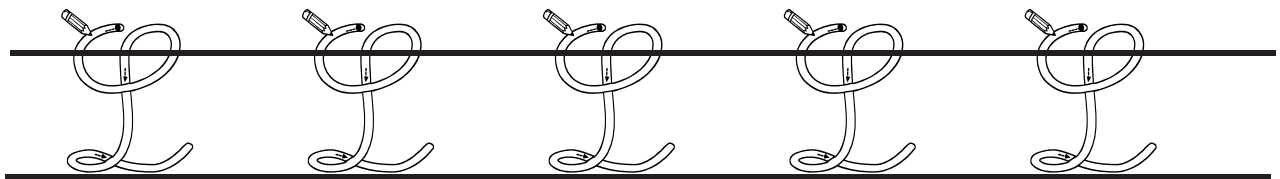
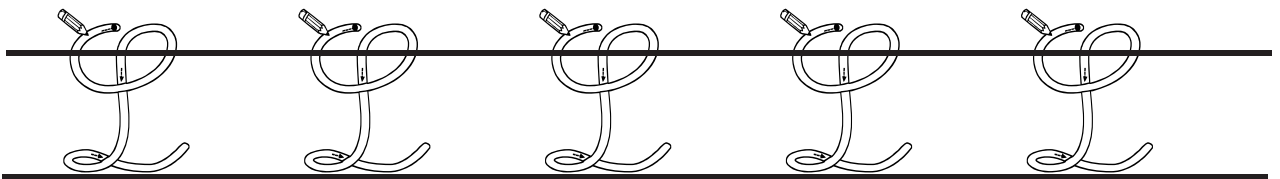
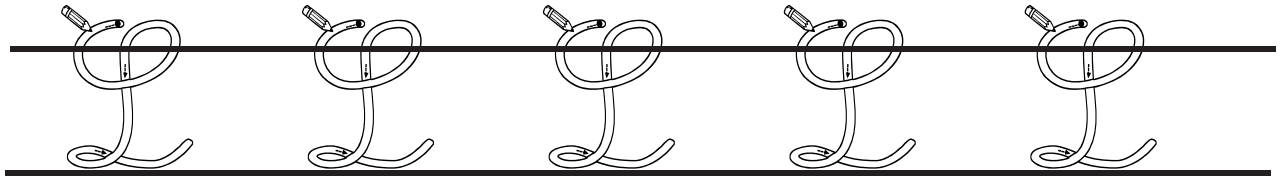
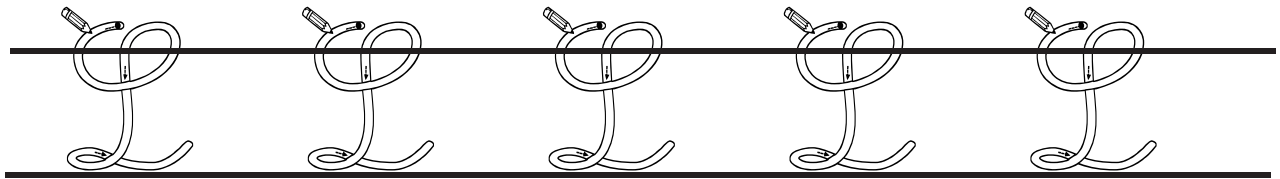
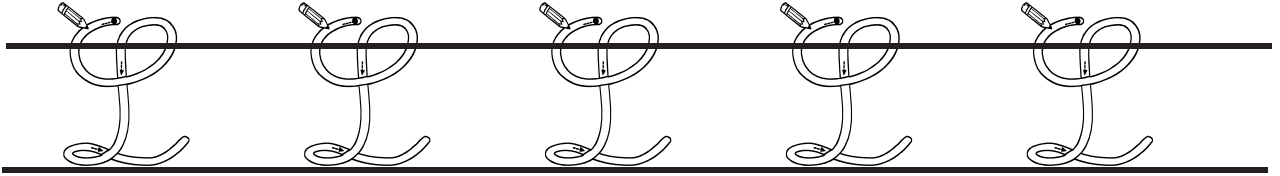

Nom _____ Date _____

Ecris la lettre L/l

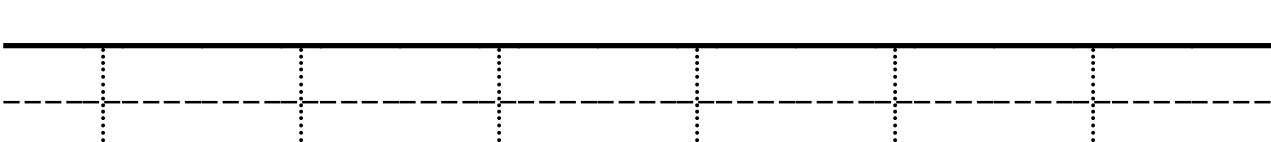
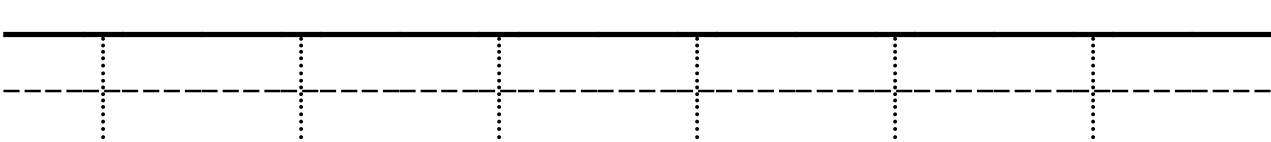
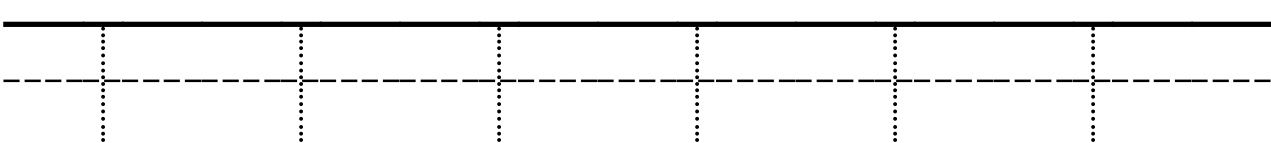
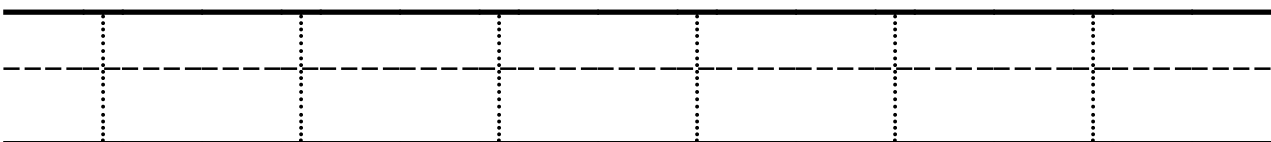
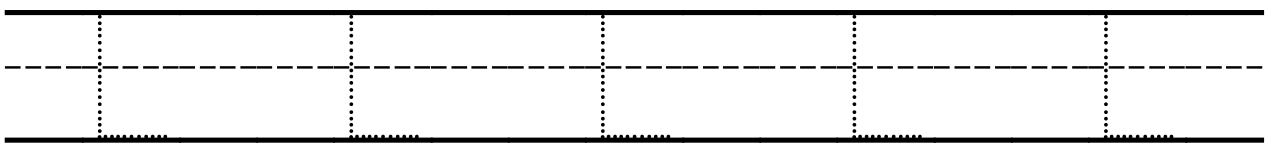
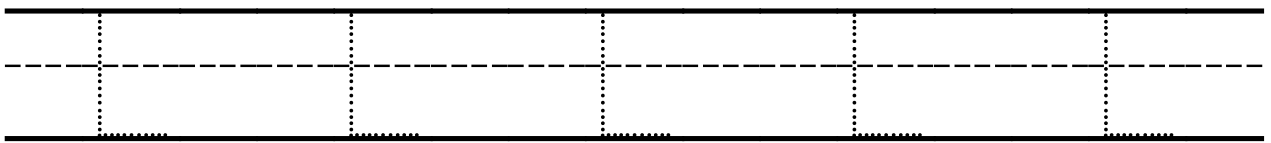
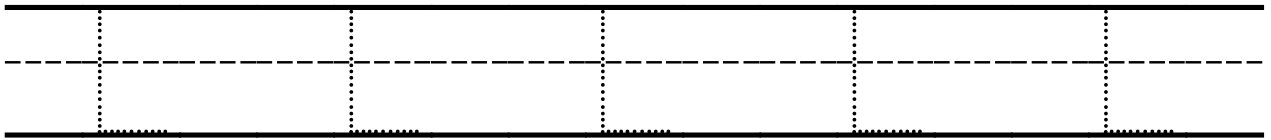
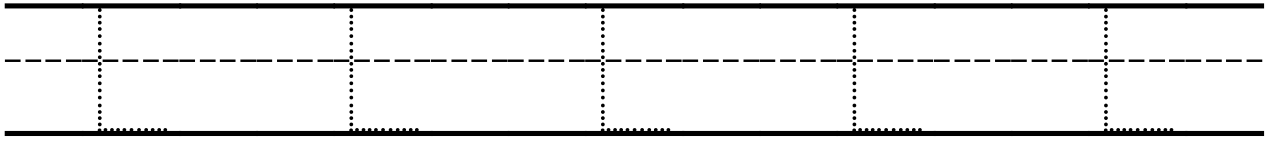

Nom _____ Date _____

Ecris la lettre L/l

L L L L L

Handwriting practice lines for uppercase letter L. The first row contains five large uppercase 'L' characters. Below this are two sets of handwriting lines, each consisting of a solid top line, a dashed middle line, and a solid bottom line.

l l l l l

Handwriting practice lines for lowercase letter l. The first row contains five large lowercase 'l' characters. Below this are two sets of handwriting lines, each consisting of a solid top line, a dashed middle line, and a solid bottom line.

Nom _____

Date _____

Colorie la lettre L

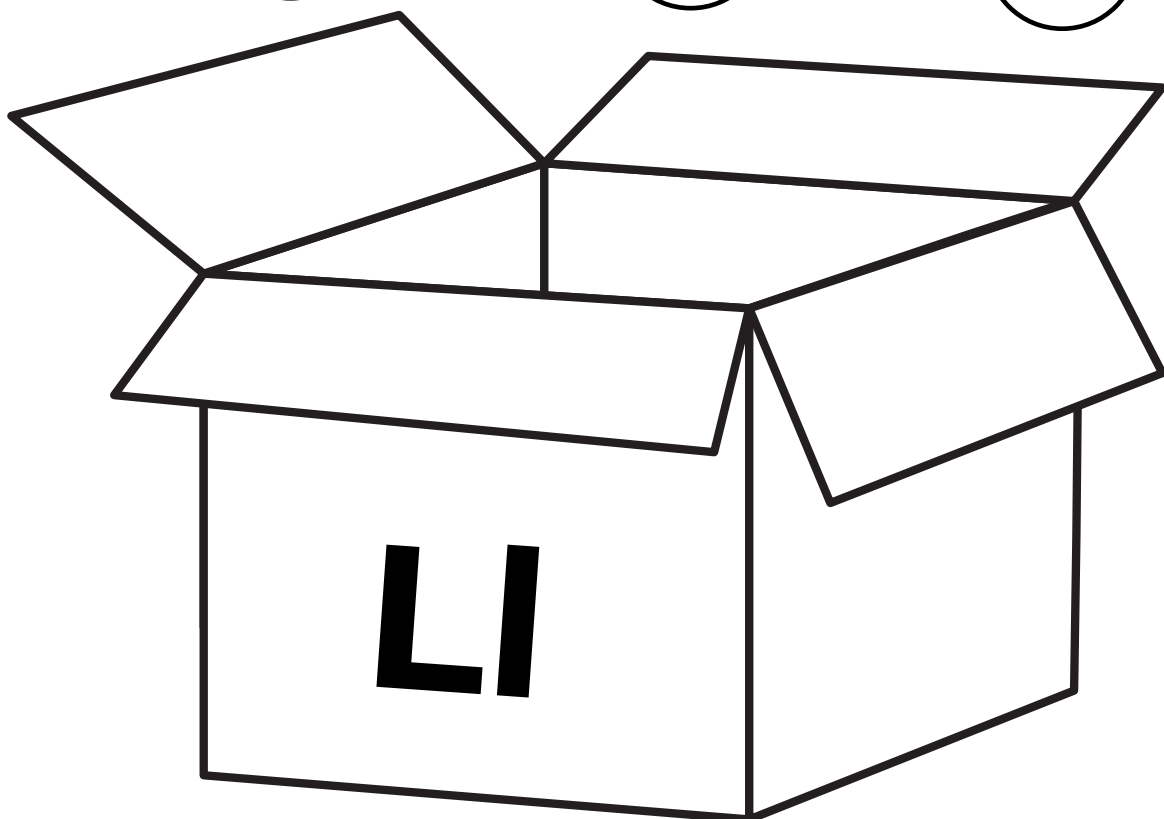
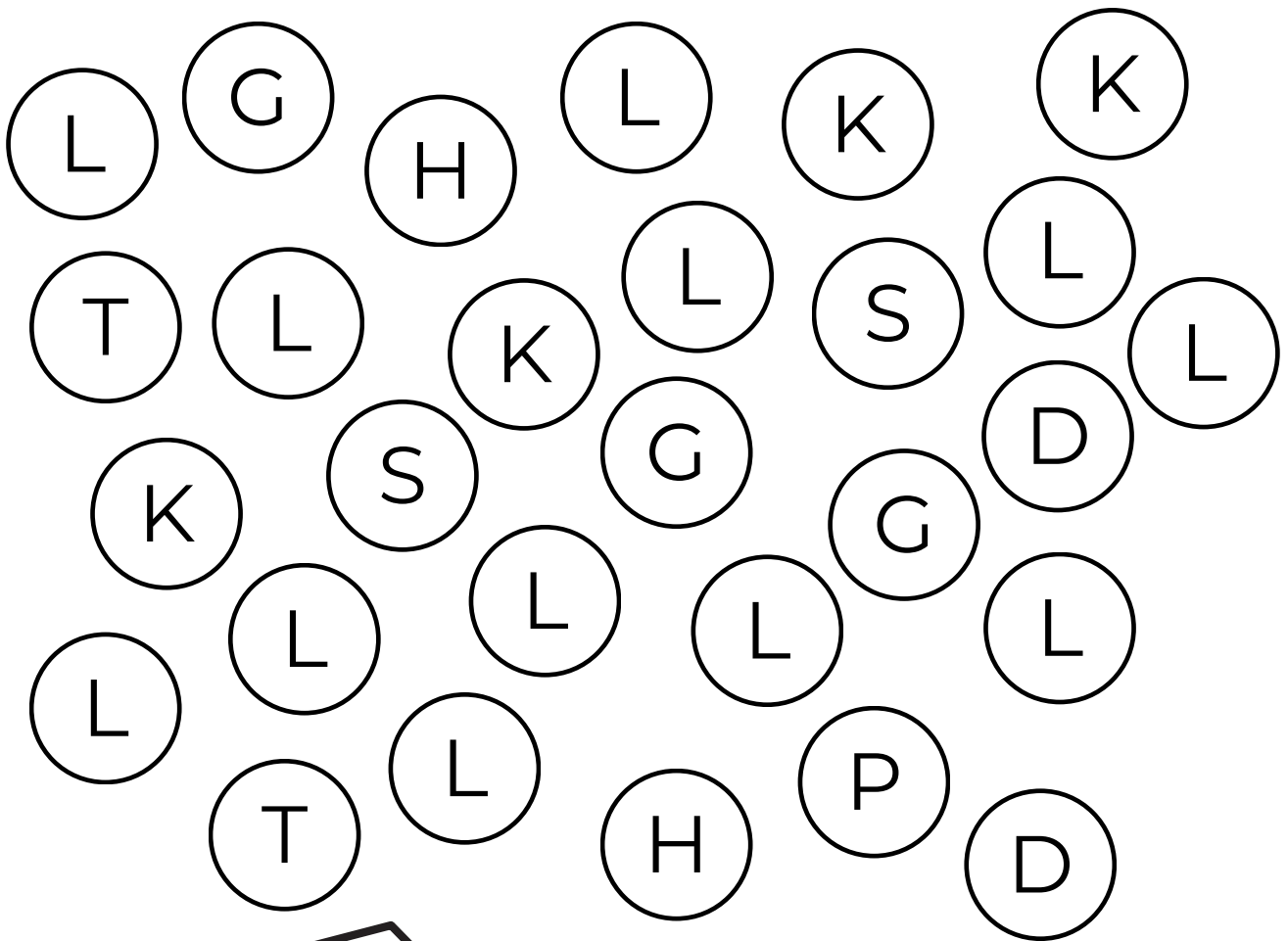

Nom _____

Date _____

Colorie la lettre l

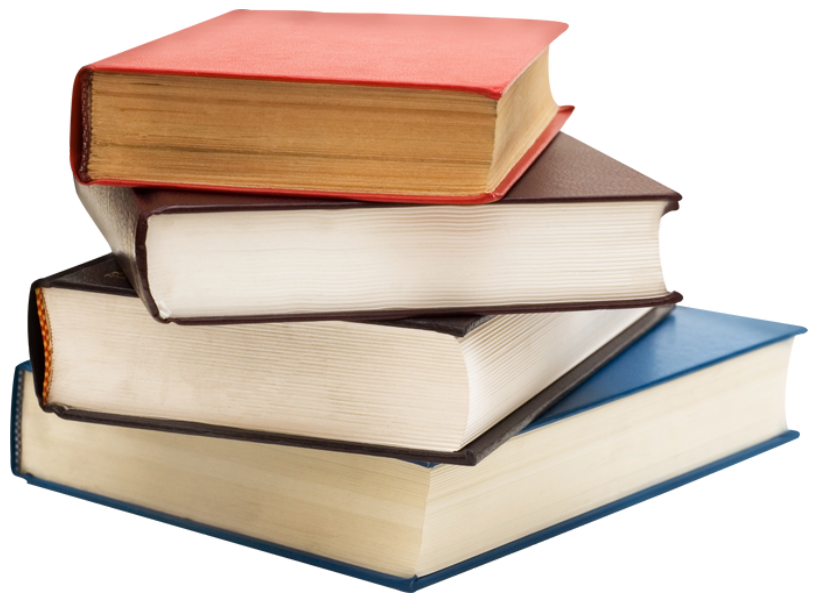
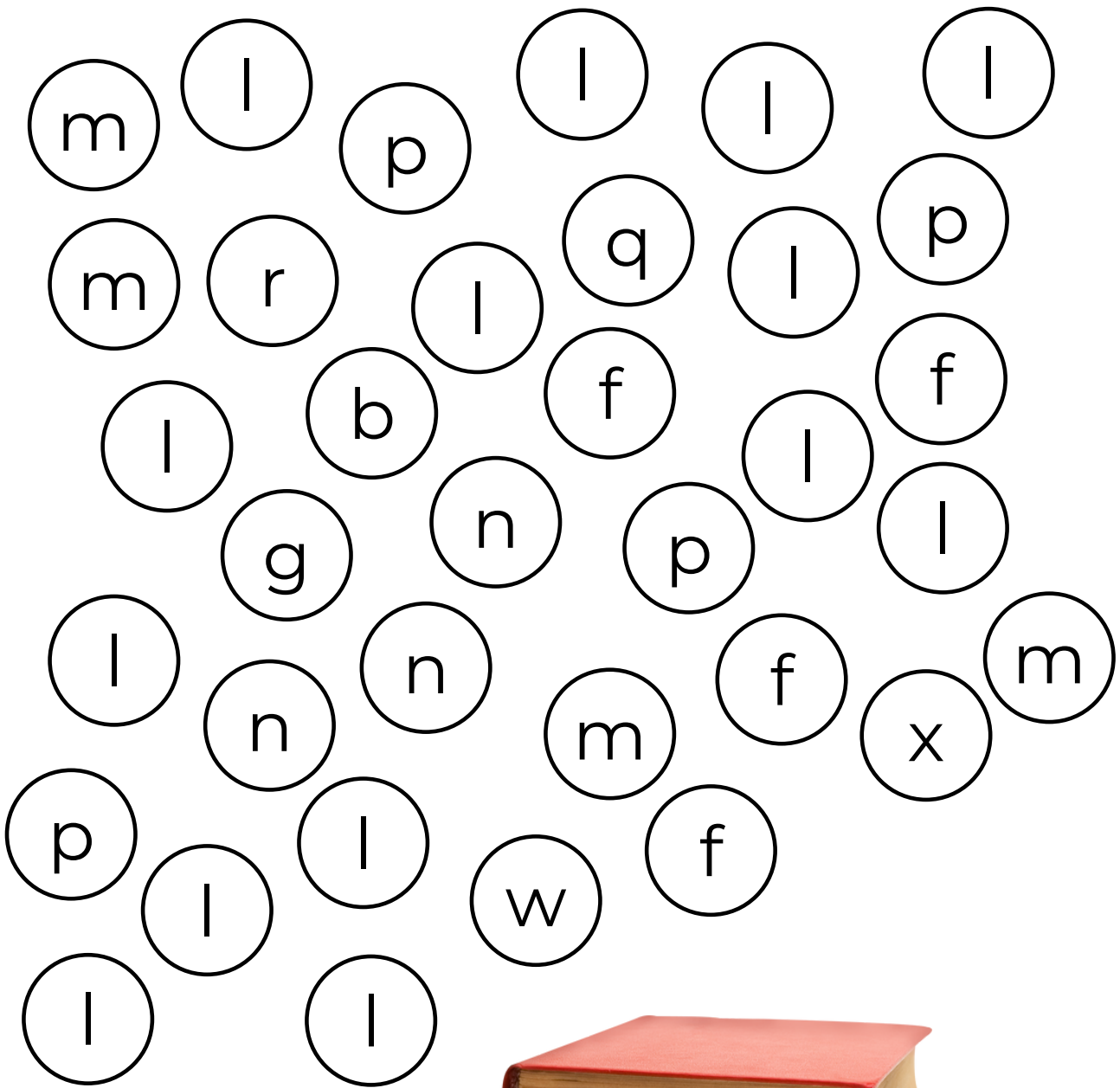

LIVRE / livre

Nom _____

Date _____

Repasse sur la lettre M / m

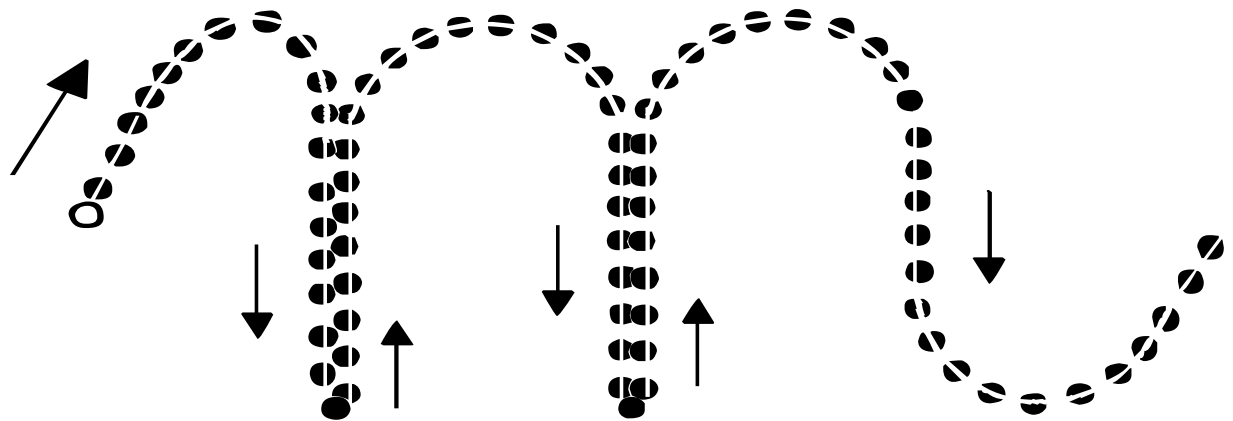

Nom _____

Date _____

Repasse sur la lettre M / m

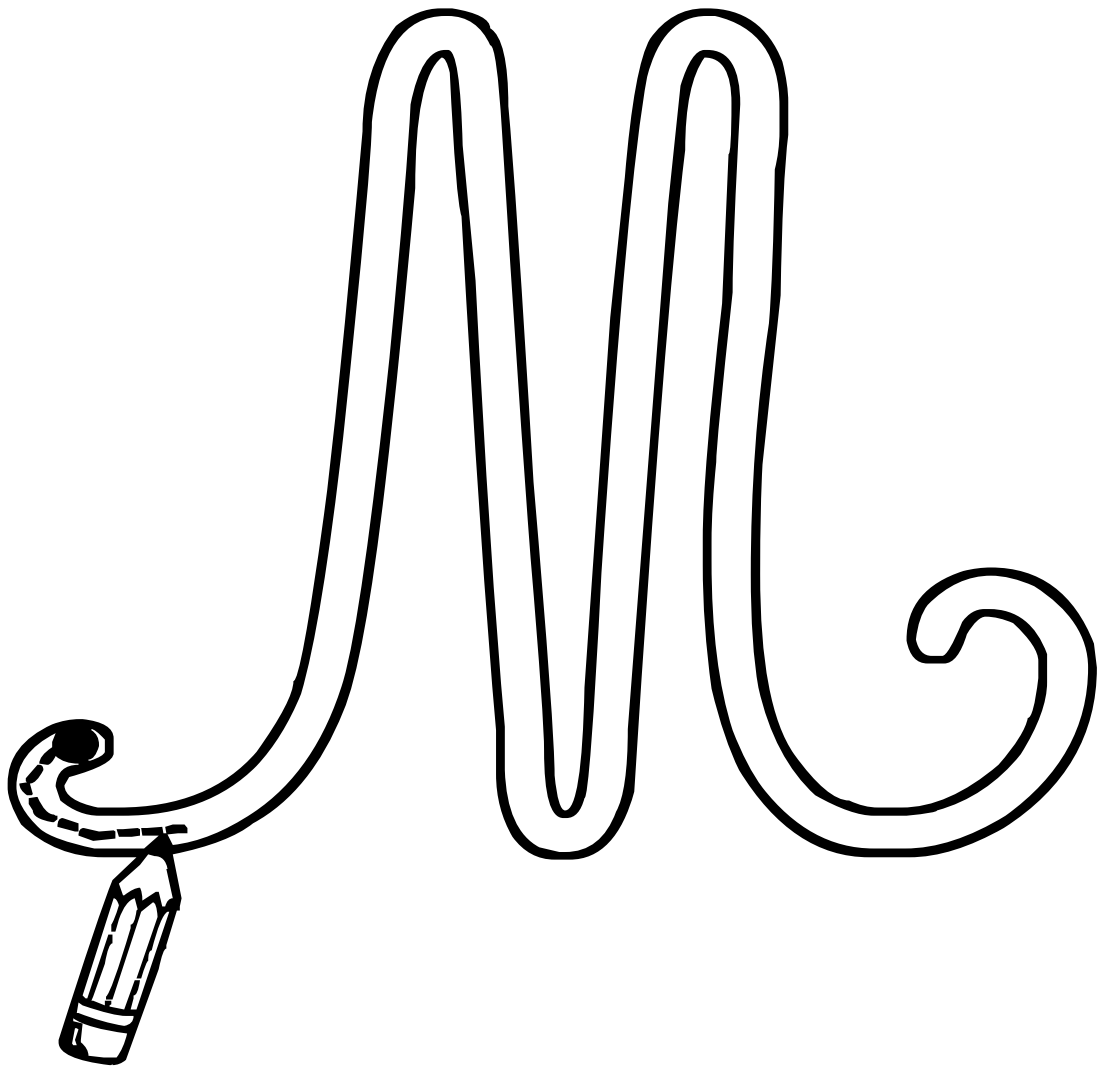

Nom _____

Date _____

Repasse sur la lettre M / m

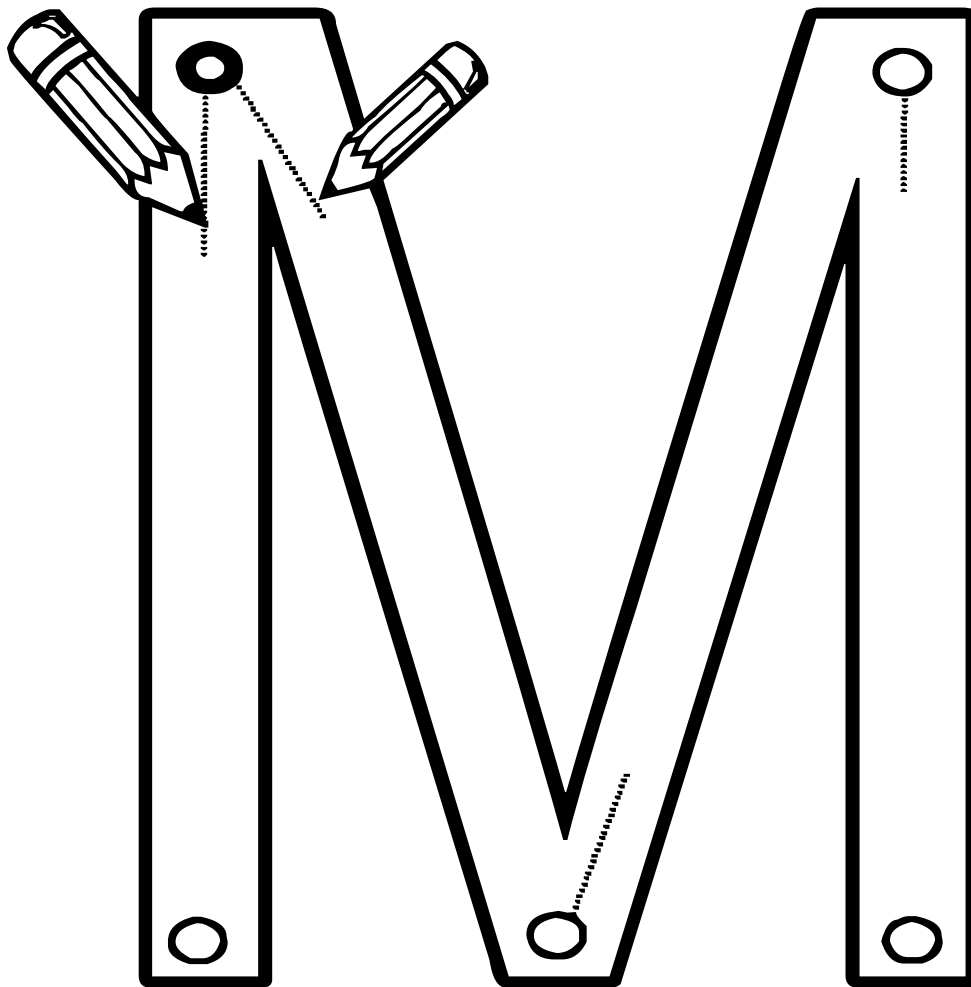

Nom _____

Date _____

Ecris la lettre M / m

m m m m m

m m m m m

m m m m m

m m m m m

m m m m m

m m m m m

m m m m m

Nom _____

Date _____

Ecris la lettre M / m

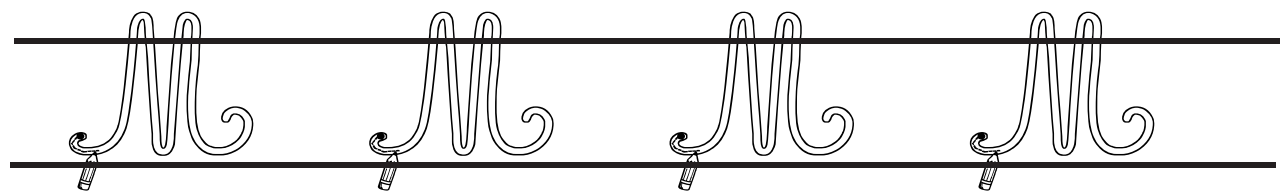
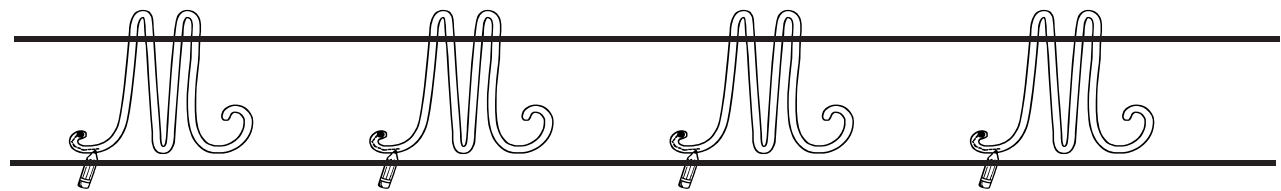
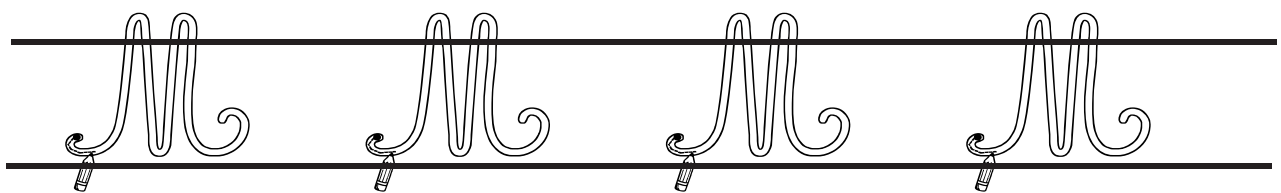
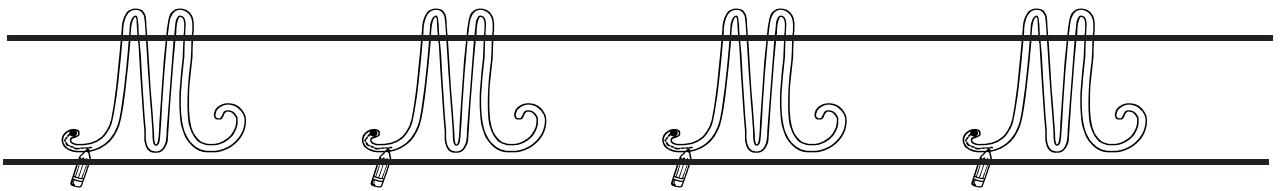
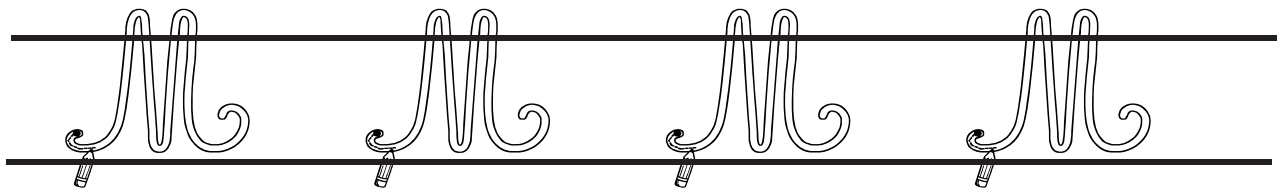
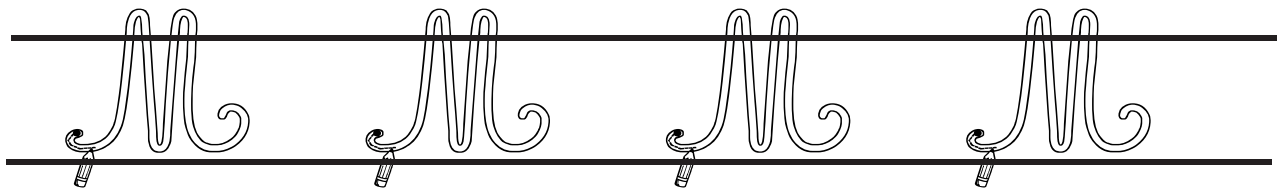
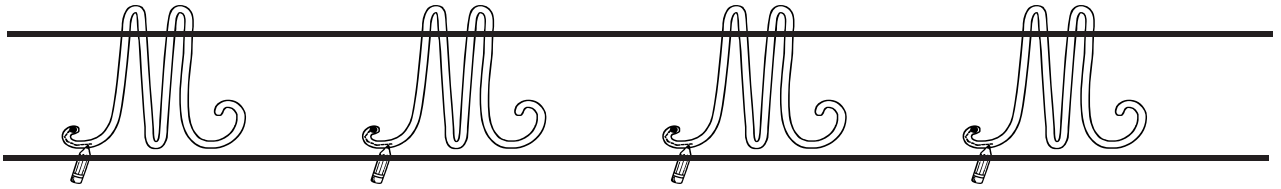

Nom _____ Date _____

Ecris la lettre M/m

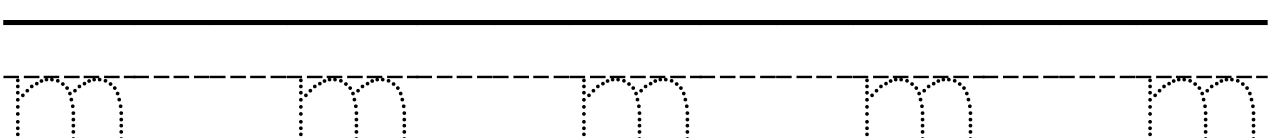
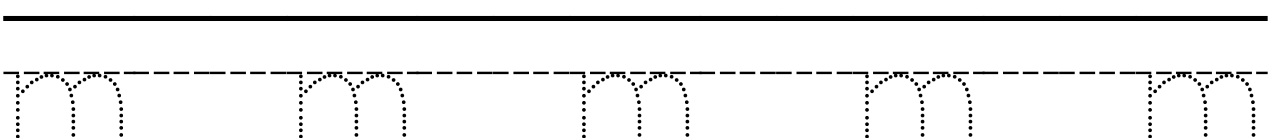
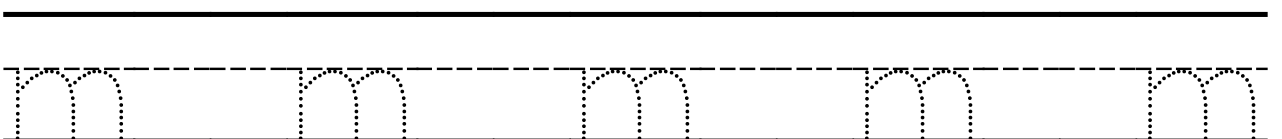
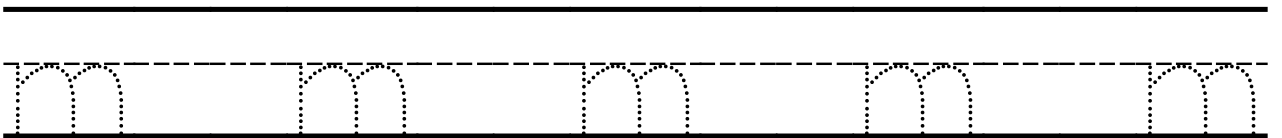
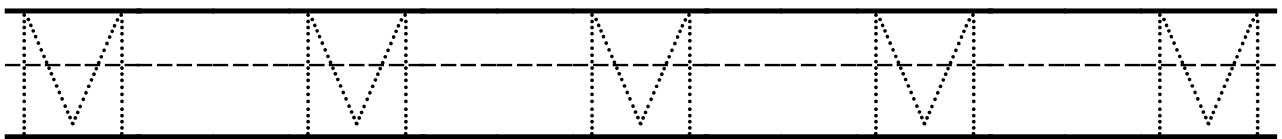
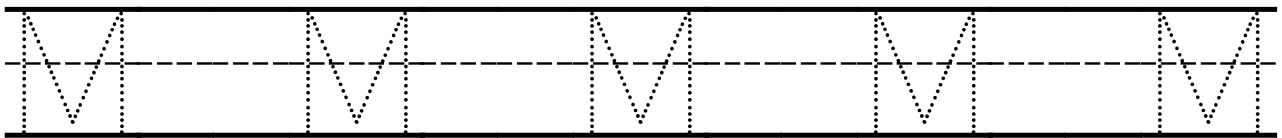
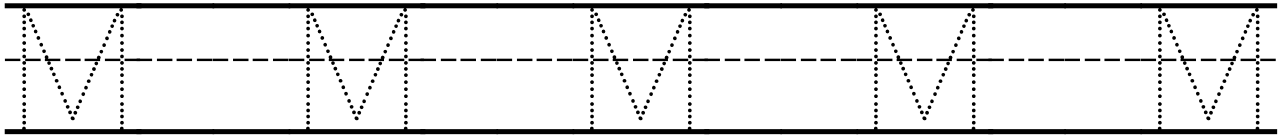
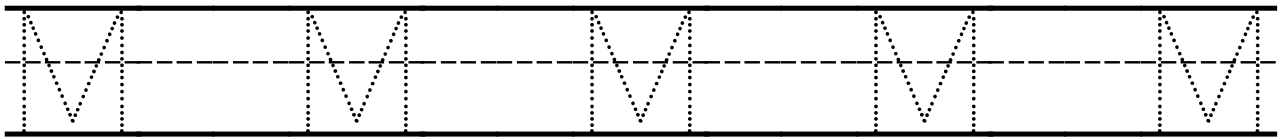

Nom _____ Date _____

Ecris la lettre M/m

M M M M M

Handwriting practice lines for uppercase letter M. The first row shows five examples of the letter M. Below are two sets of blank handwriting lines, each consisting of a solid top line, a dashed middle line, and a solid bottom line.

m m m m m

Handwriting practice lines for lowercase letter m. The first row shows five examples of the letter m. Below are two sets of blank handwriting lines, each consisting of a solid top line, a dashed middle line, and a solid bottom line.

Nom _____ Date _____

Colorie la lettre M

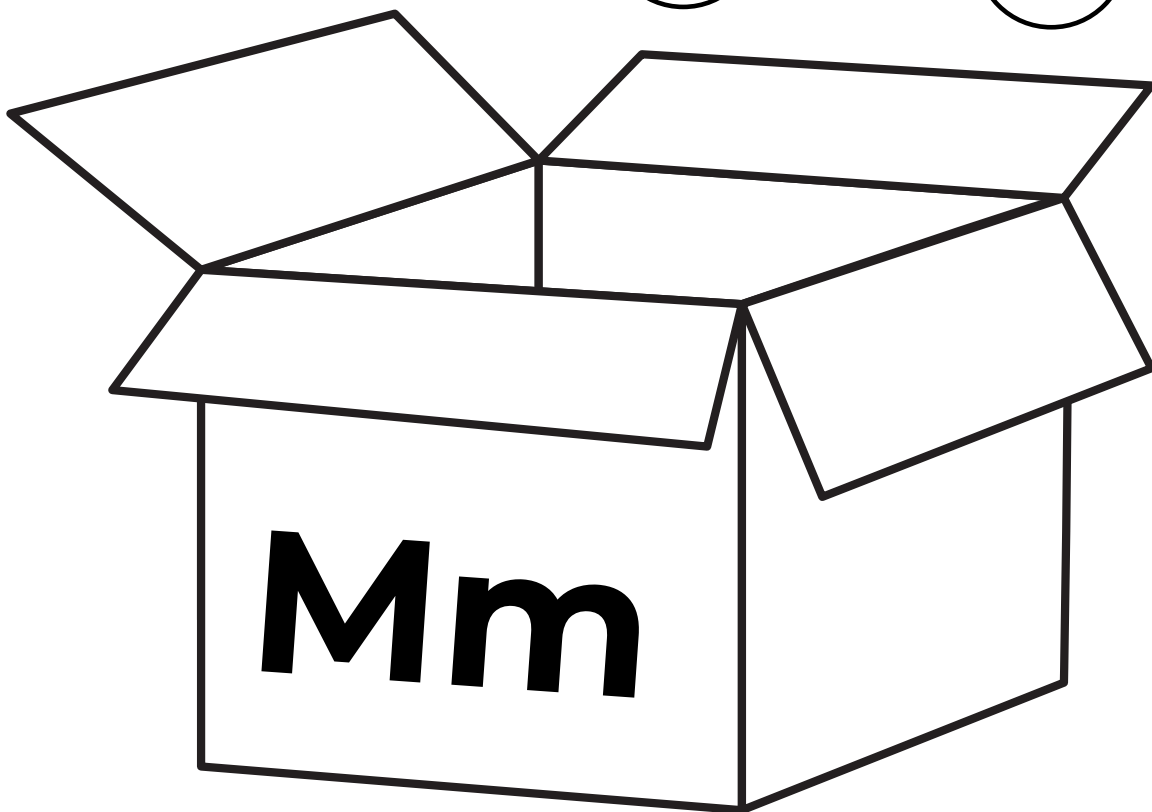
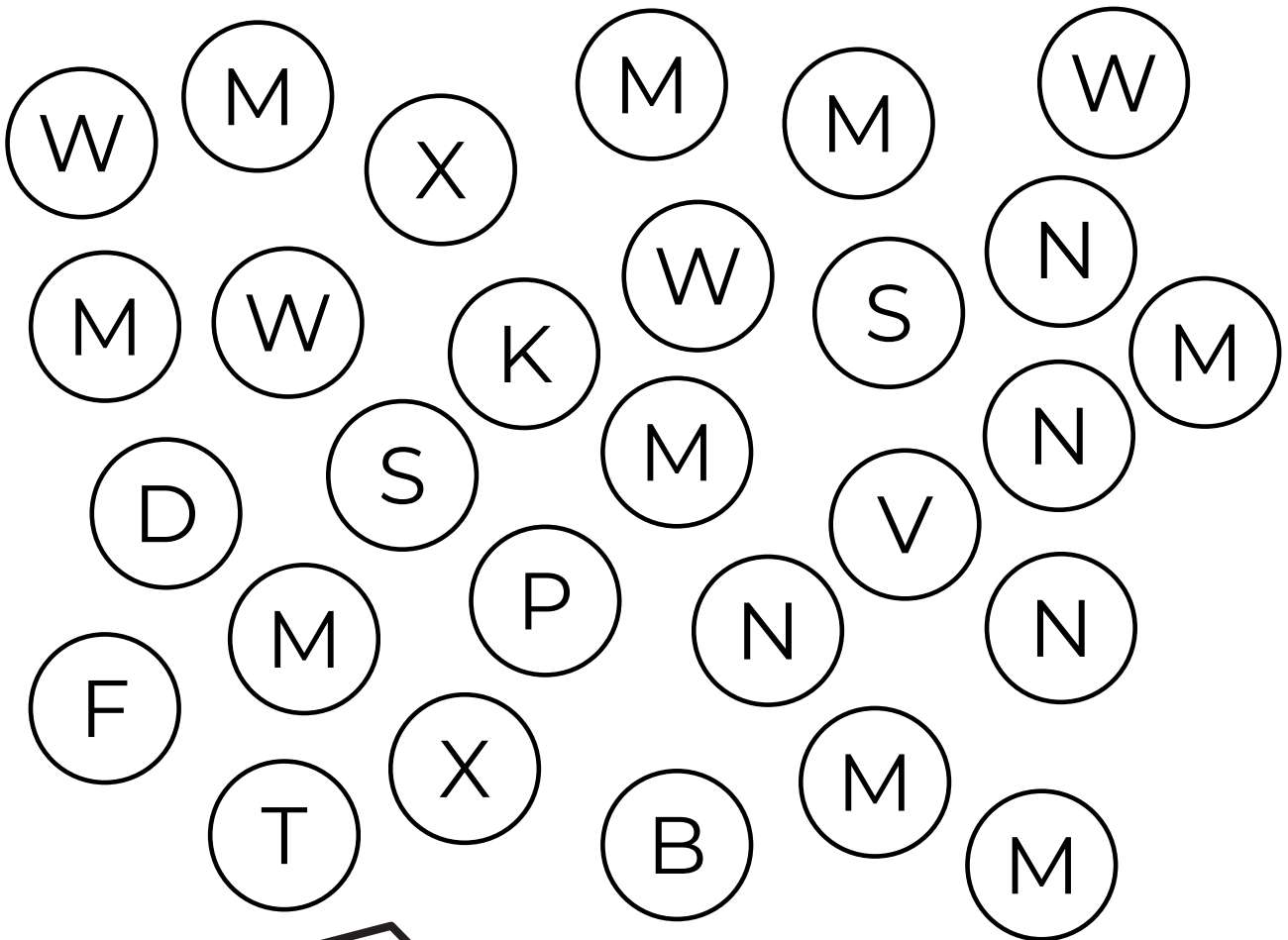

Nom _____

Date _____

Colorie la lettre m

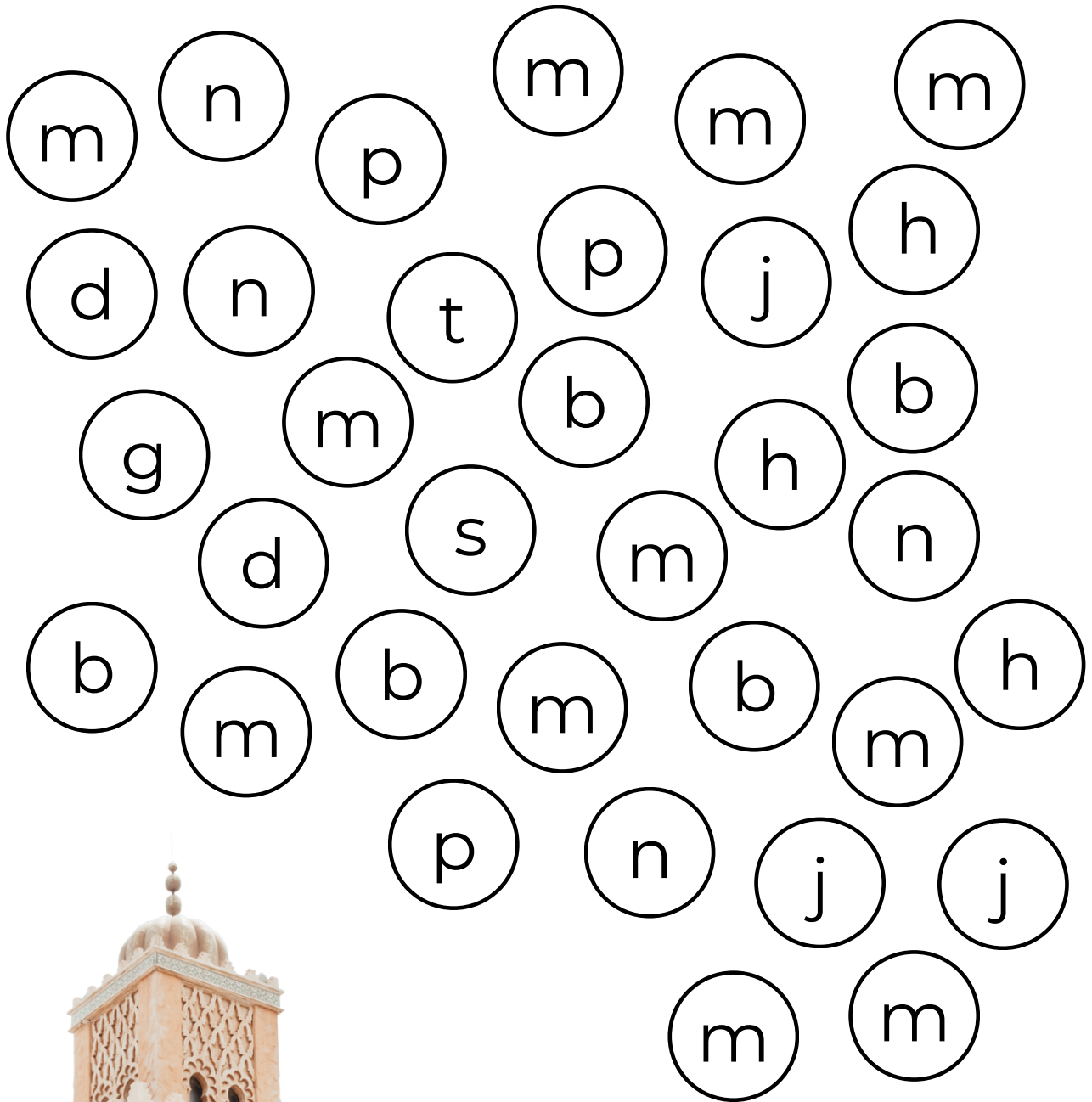

MOSQUEE / mosquée

Nom _____

Date _____

Repasse sur la lettre N / n

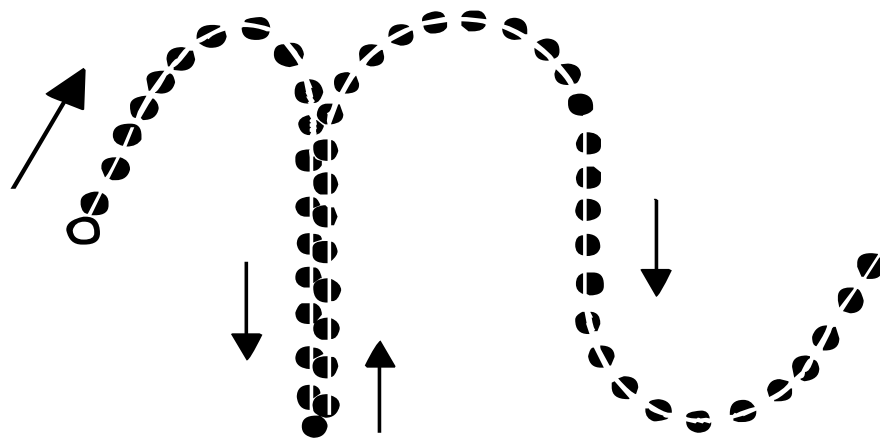

Nom _____

Date _____

Repasse sur la lettre N / n

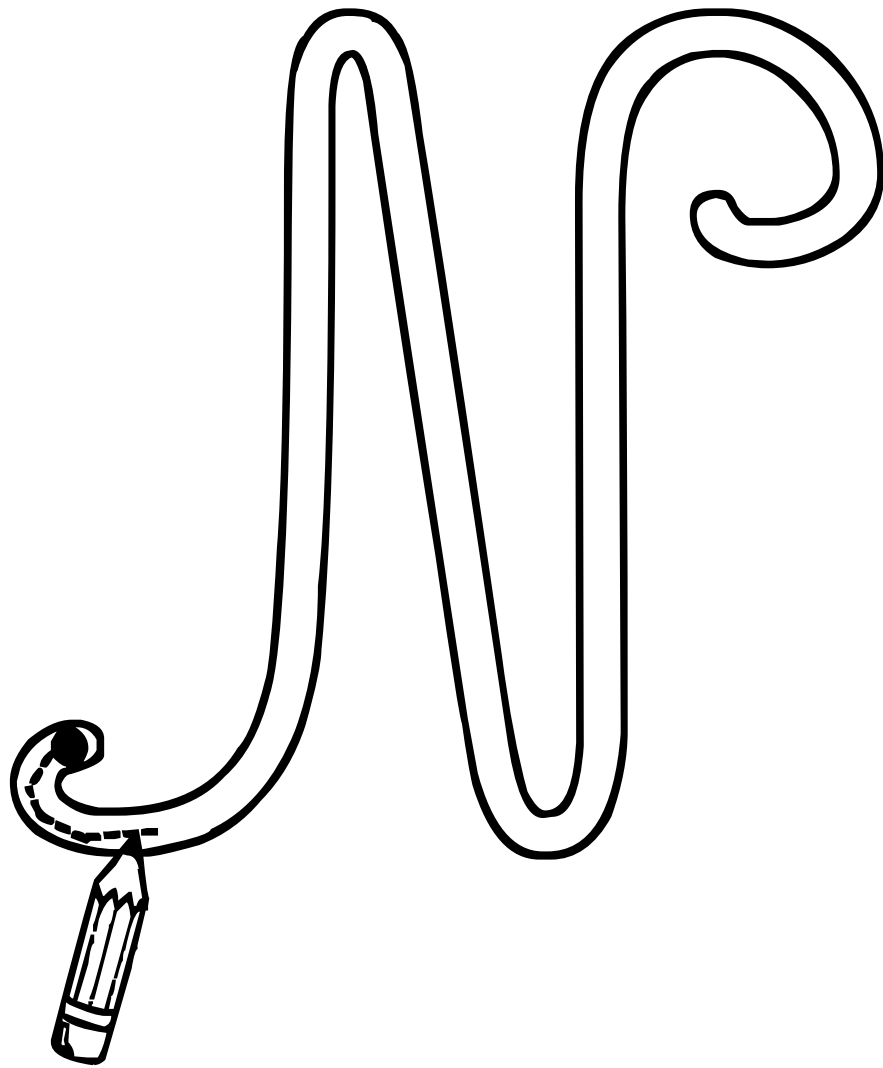

Nom _____

Date _____

Repasse sur la lettre N / n

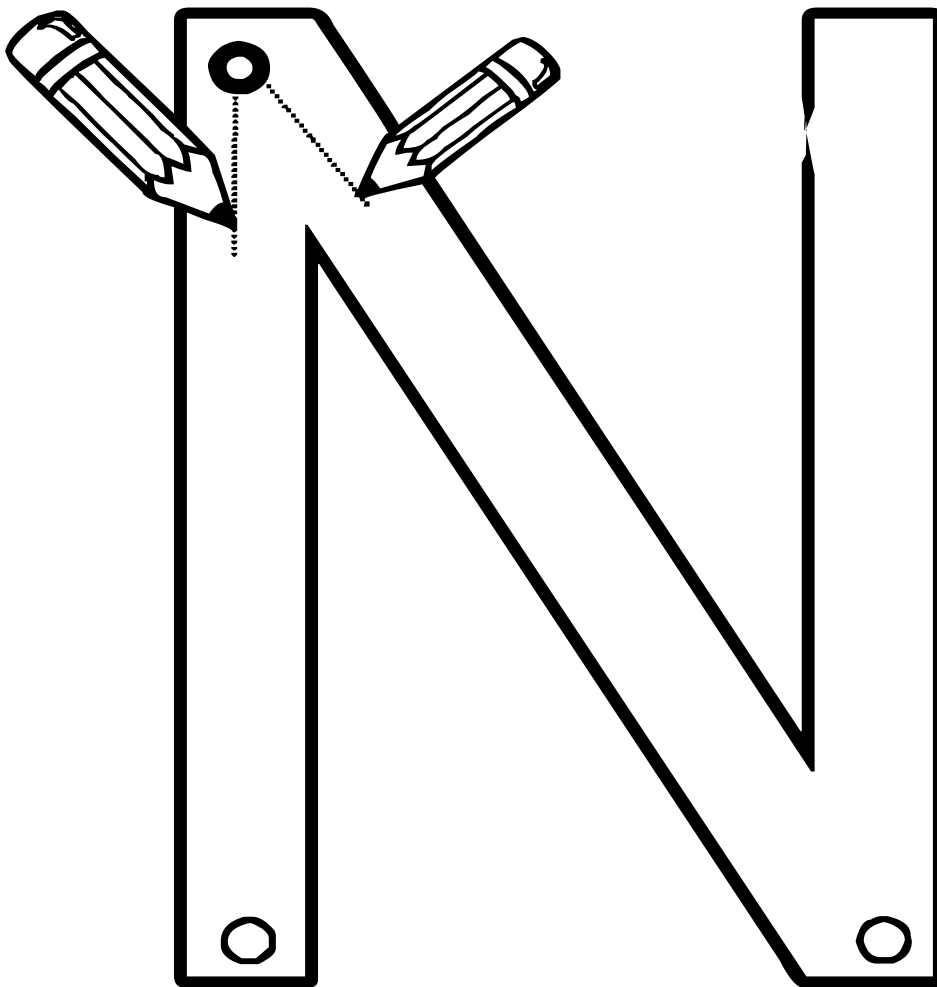

Nom _____

Date _____

Ecris la lettre N / n

n n n n n n

n n n n n n

n n n n n n

n n n n n n

n n n n n n

n n n n n n

n n n n n n

Nom _____

Date _____

Ecris la lettre N / n

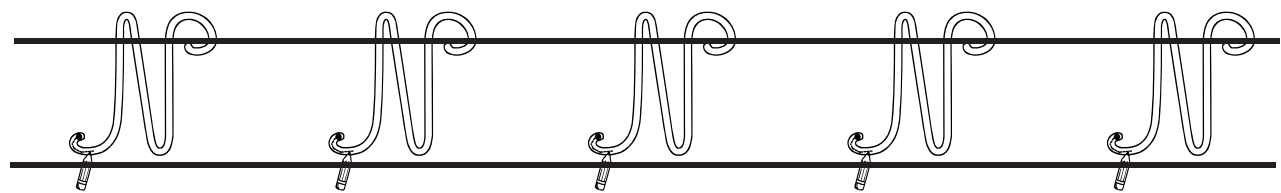
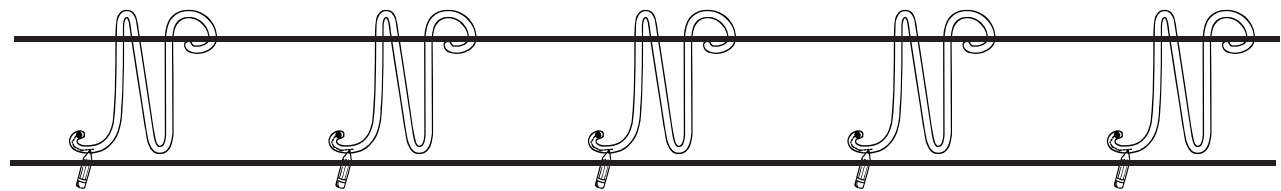
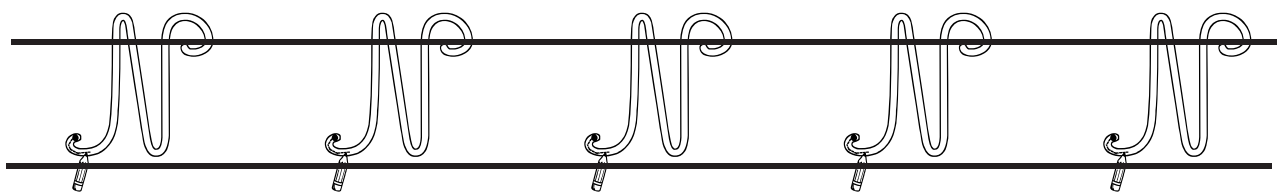
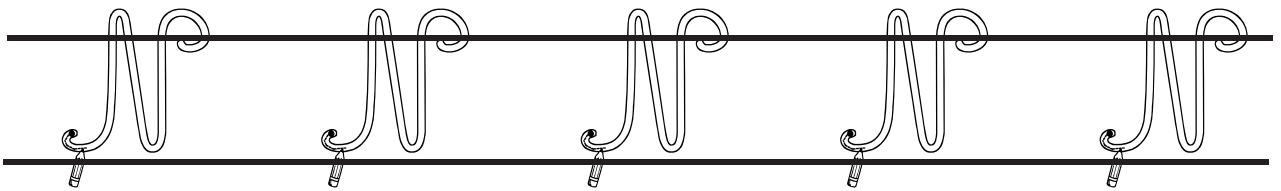
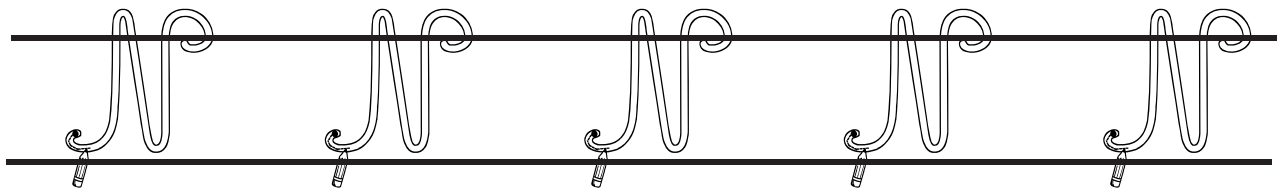
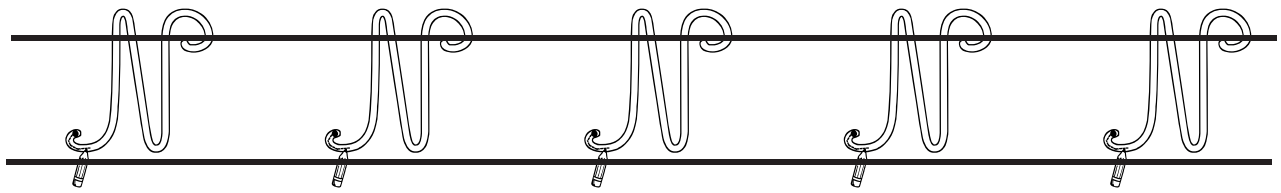
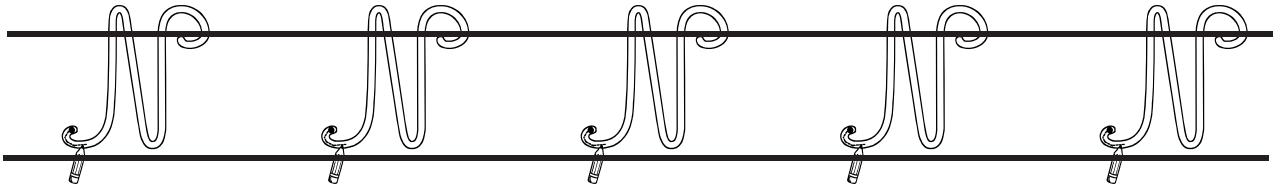

Nom _____

Date _____

Ecris la lettre N/n

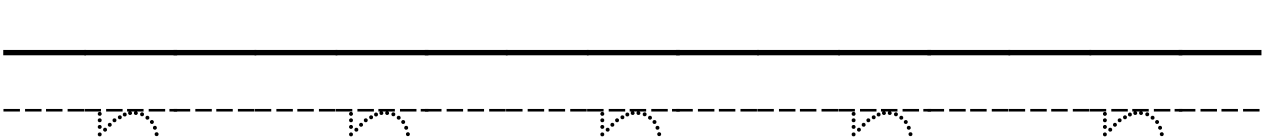
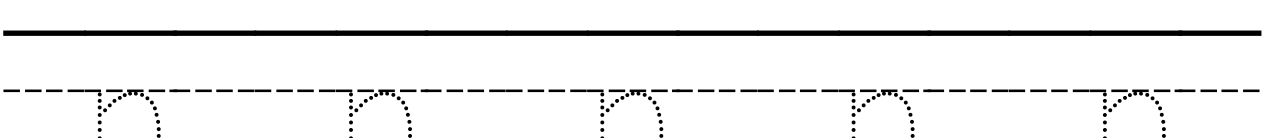
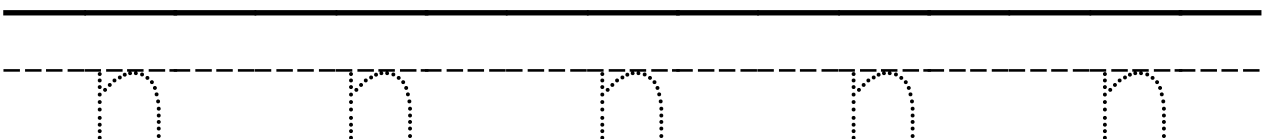
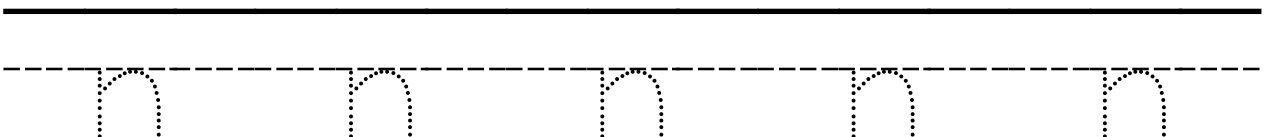
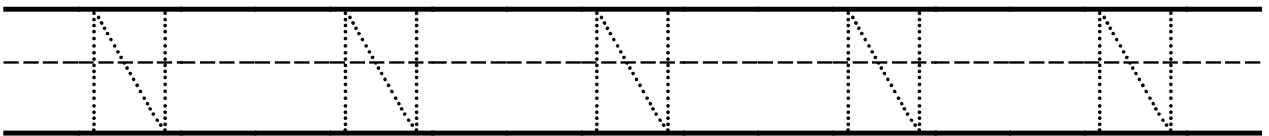
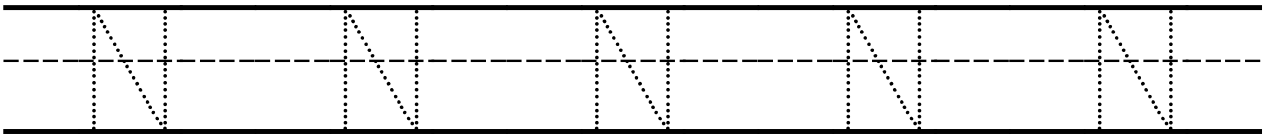
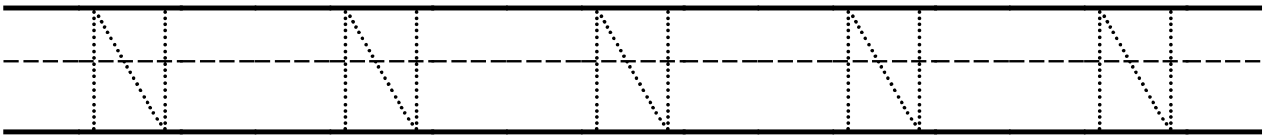
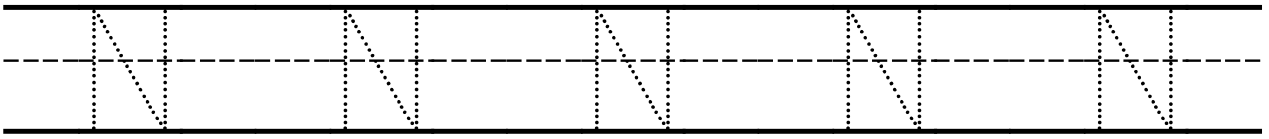

Nom _____ Date _____

Ecris la lettre N/n

N N N N N

Handwriting practice lines for uppercase 'N'. The first set consists of a solid top line, a dashed middle line, and a solid bottom line. The second set consists of a solid top line, a dashed middle line, and a solid bottom line.

n n n n n

Handwriting practice lines for lowercase 'n'. The first set consists of a solid top line, a dashed middle line, and a solid bottom line. The second set consists of a solid top line, a dashed middle line, and a solid bottom line.

Nom _____

Date _____

Colorie la lettre N

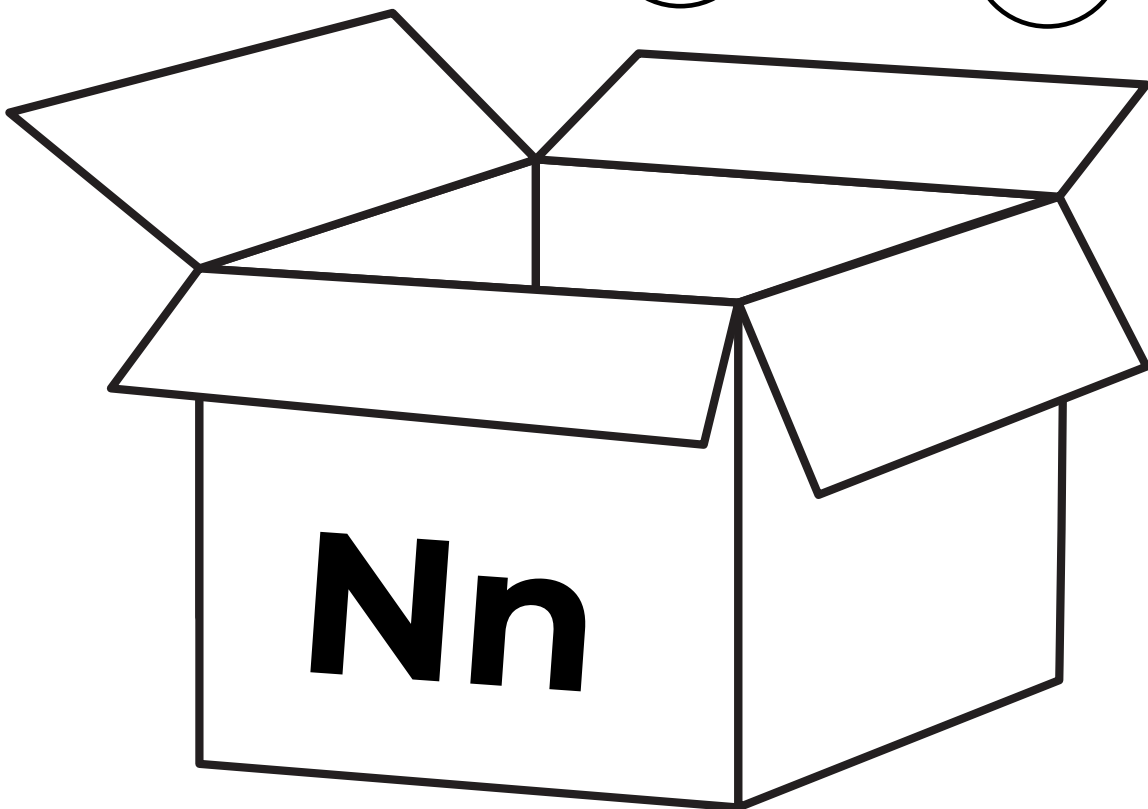
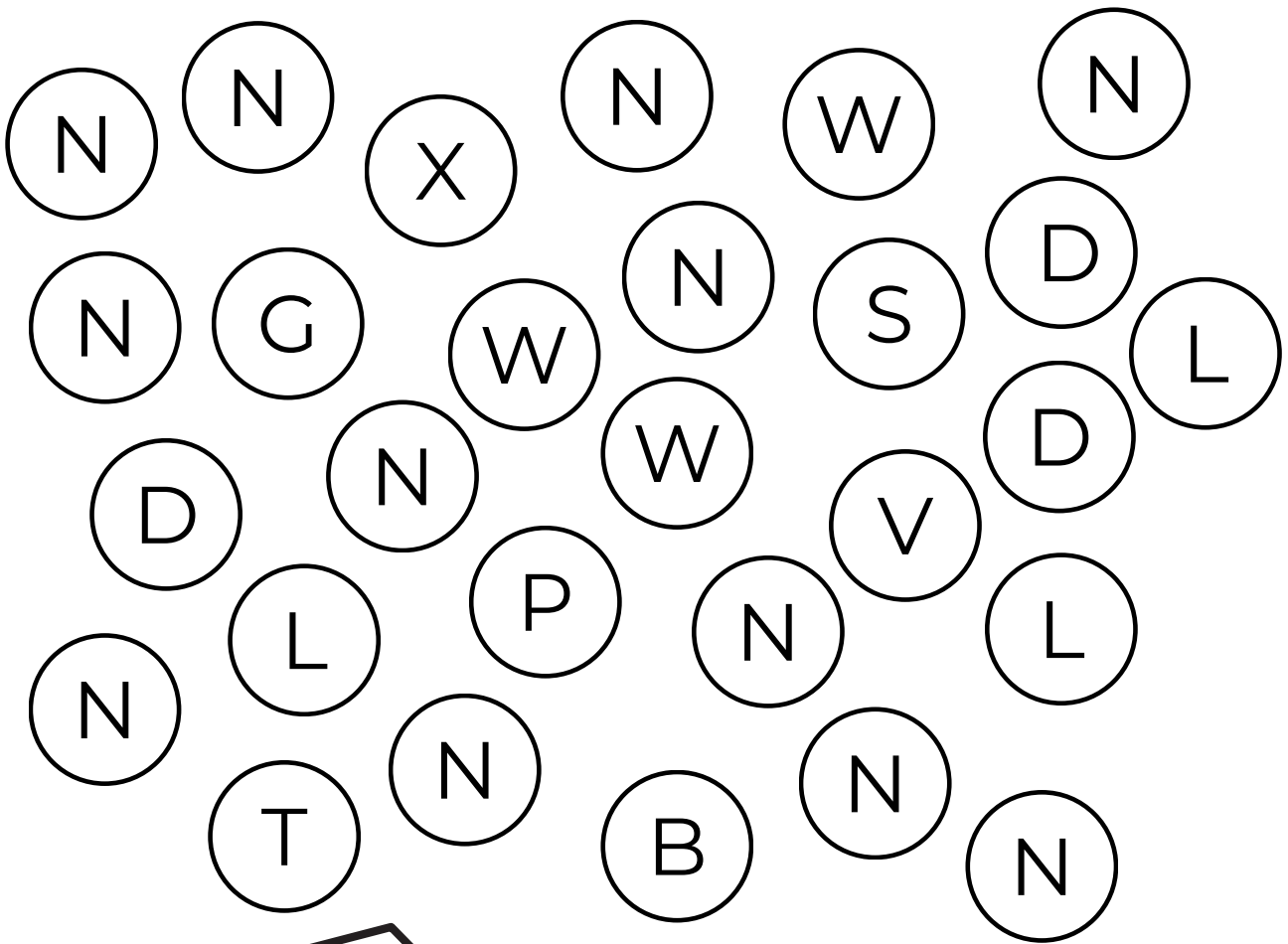

Nom _____

Date _____

Colorie la lettre n

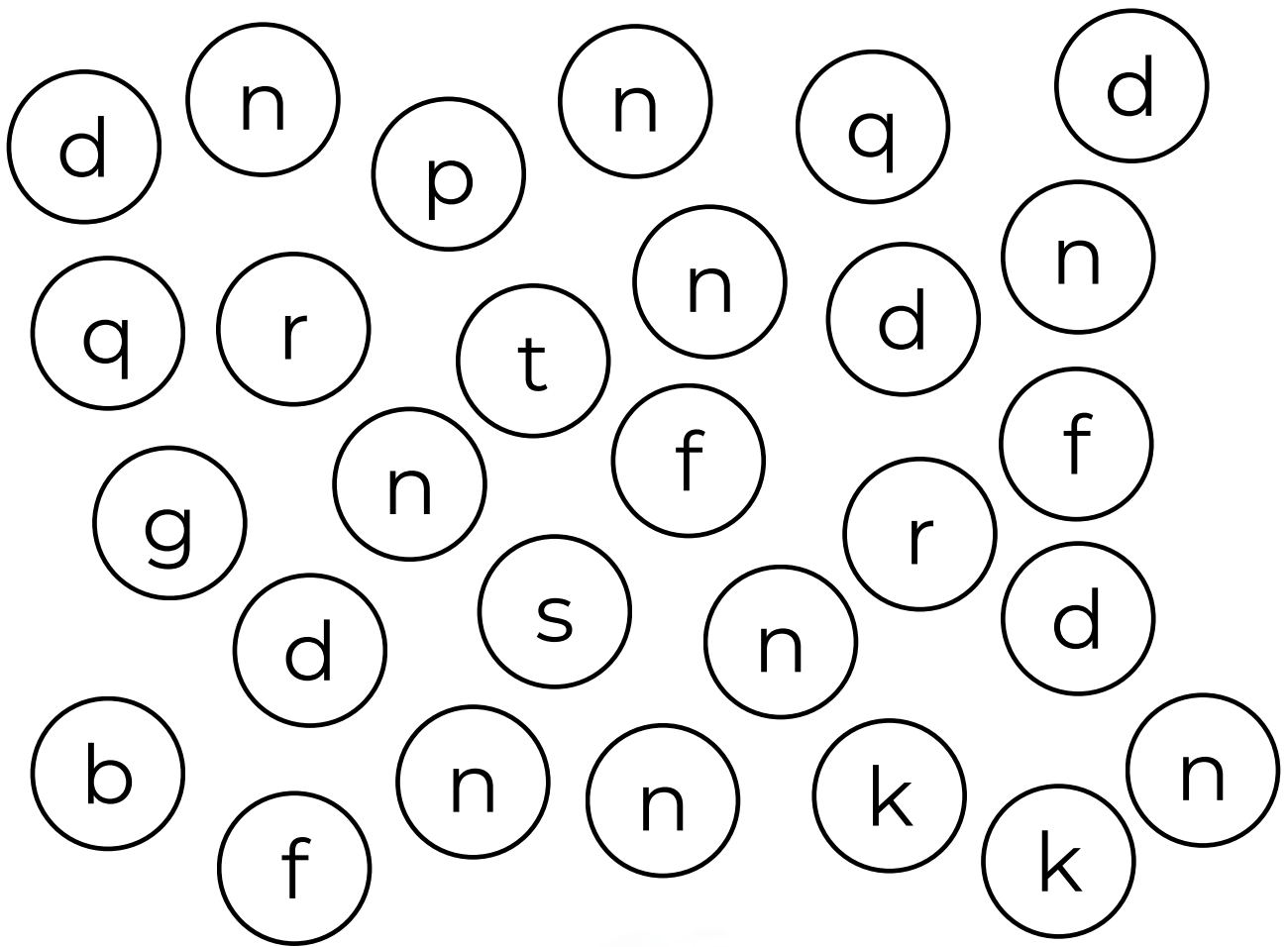

NUAGE / nuage

Nom _____

Date _____

Repasse sur la lettre O / o

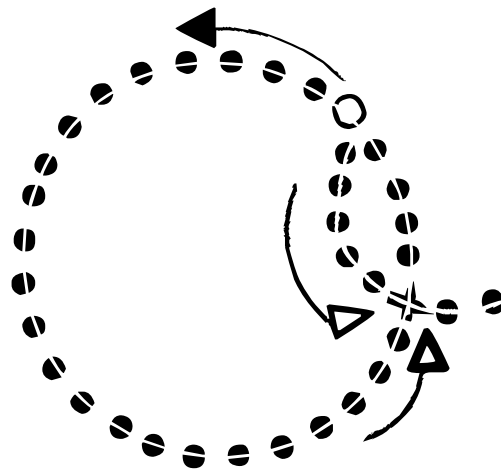

Nom _____

Date _____

Repasse sur la lettre O / o

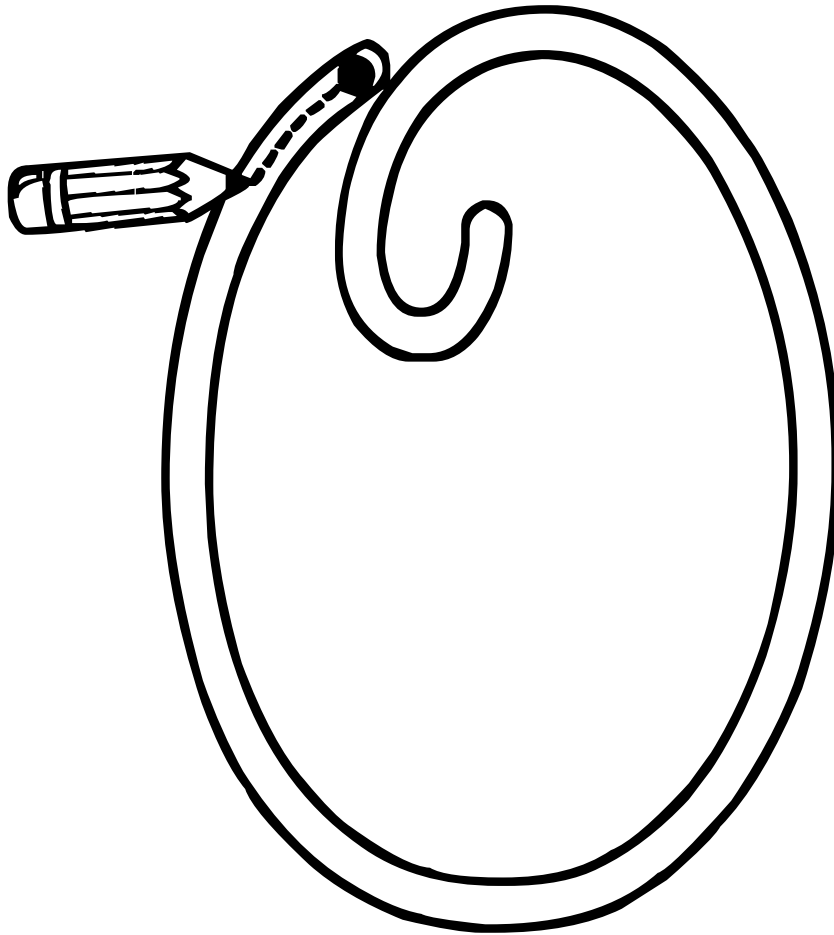

Nom _____

Date _____

Repasse sur la lettre O / o

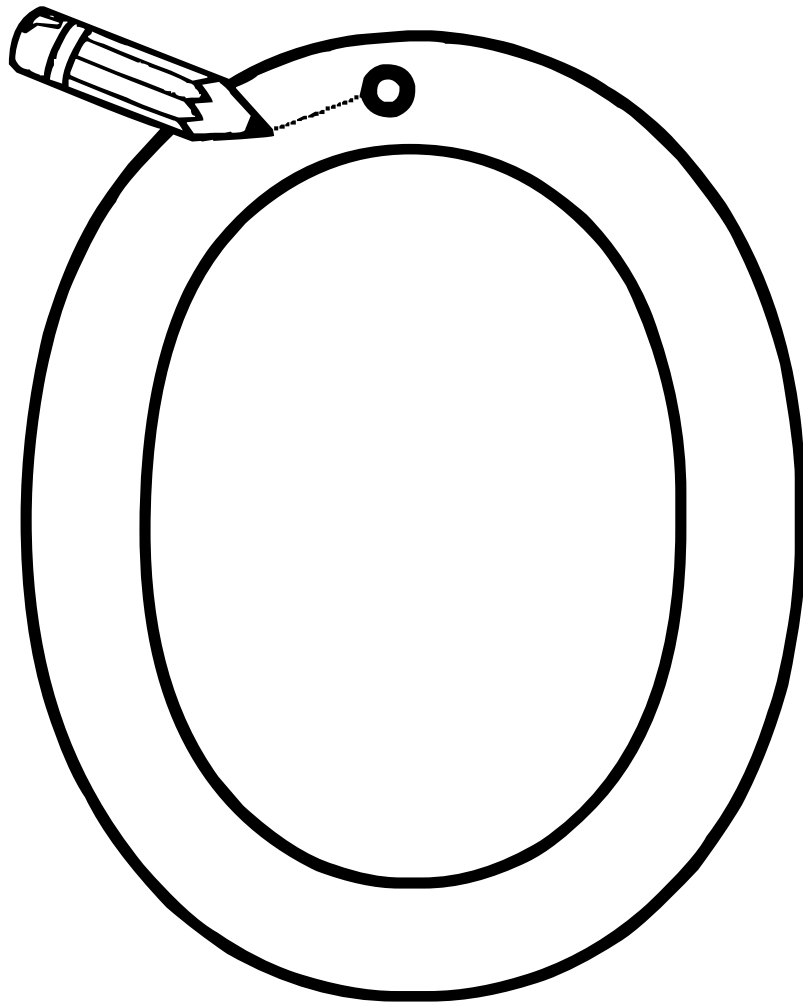

Nom _____ Date _____

Ecris la lettre O / o



Nom _____

Date _____

Ecris la lettre O / o

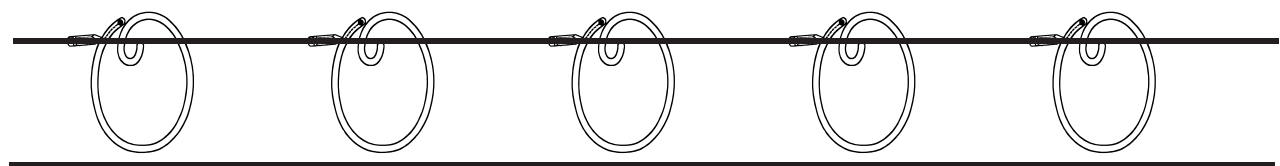
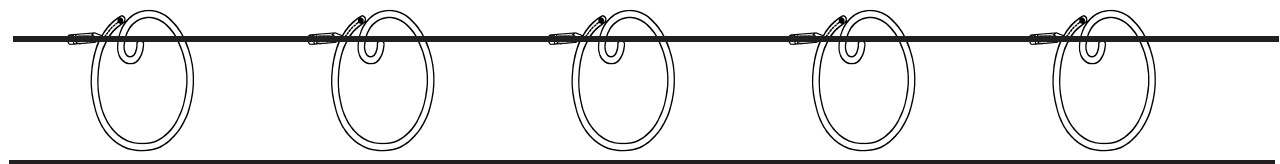
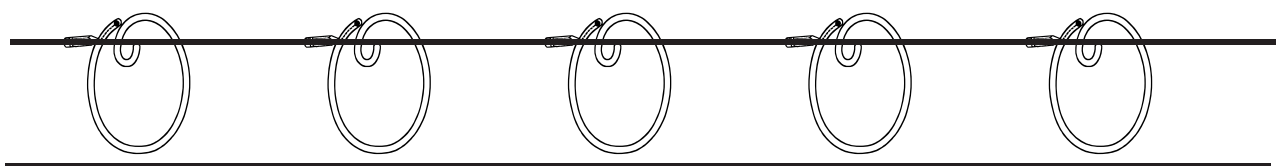
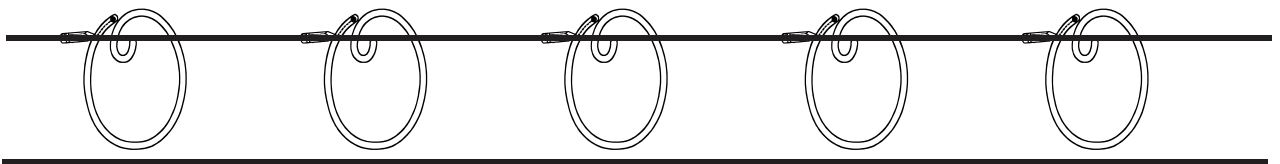
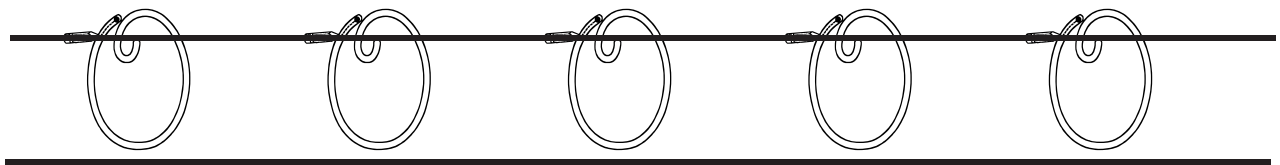
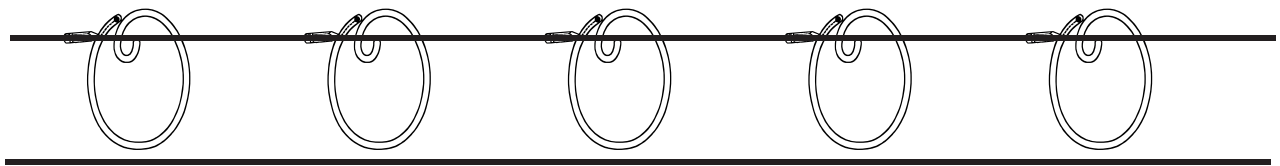
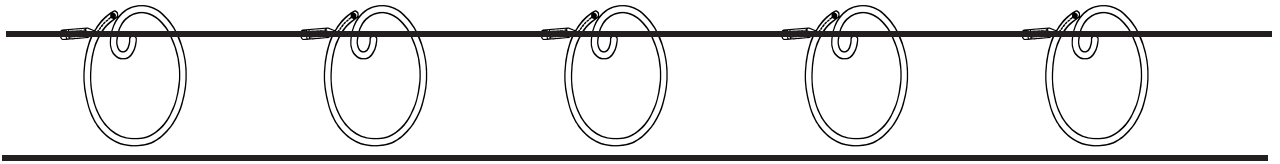

Nom _____ Date _____

Ecris la lettre O/o

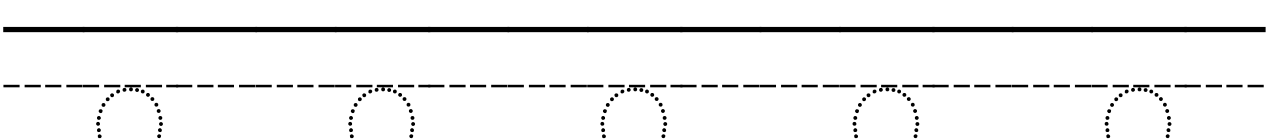
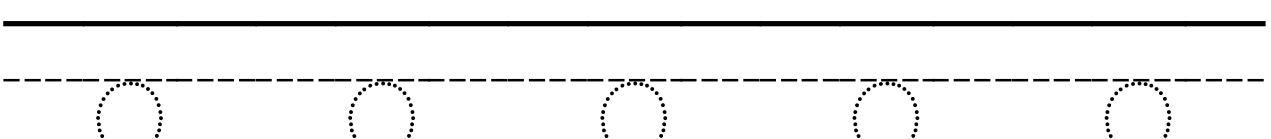
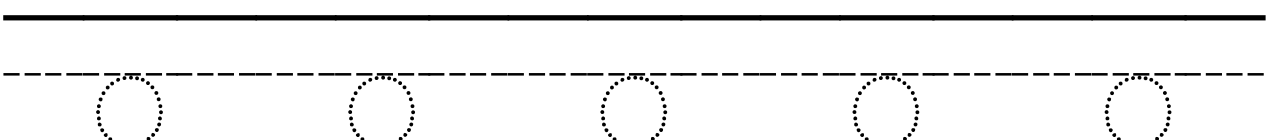
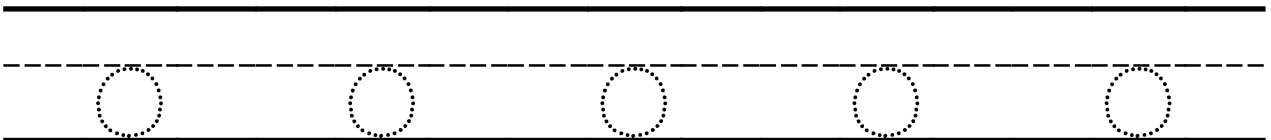
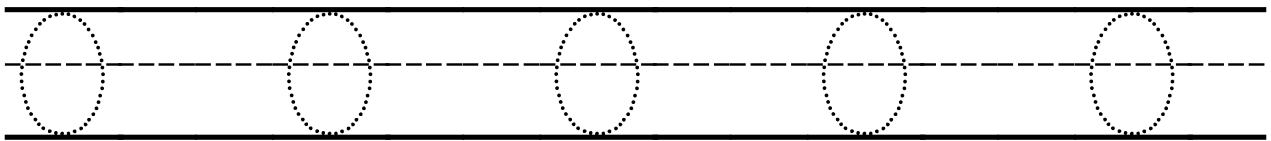
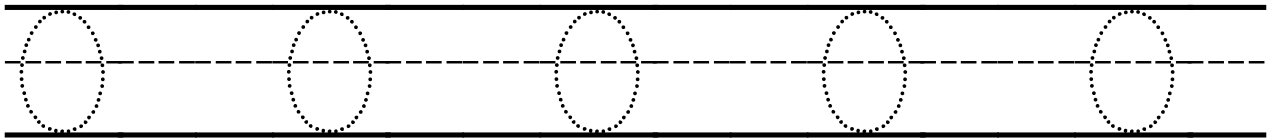
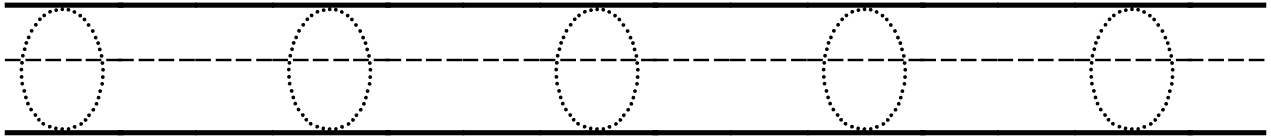
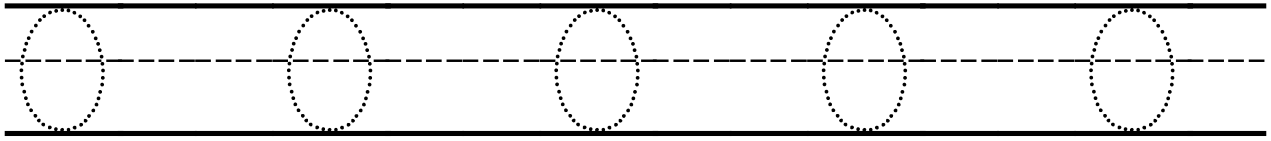

Nom _____ Date _____

Ecris la lettre O/o

O O O O O

Handwriting practice lines for uppercase 'O'. Each set consists of a solid top line, a dashed middle line, and a solid bottom line. There are two such sets of lines provided for practice.

o o o o o

Handwriting practice lines for lowercase 'o'. Each set consists of a solid top line, a dashed middle line, and a solid bottom line. There are two such sets of lines provided for practice.

Nom _____

Date _____

Colorie la lettre O

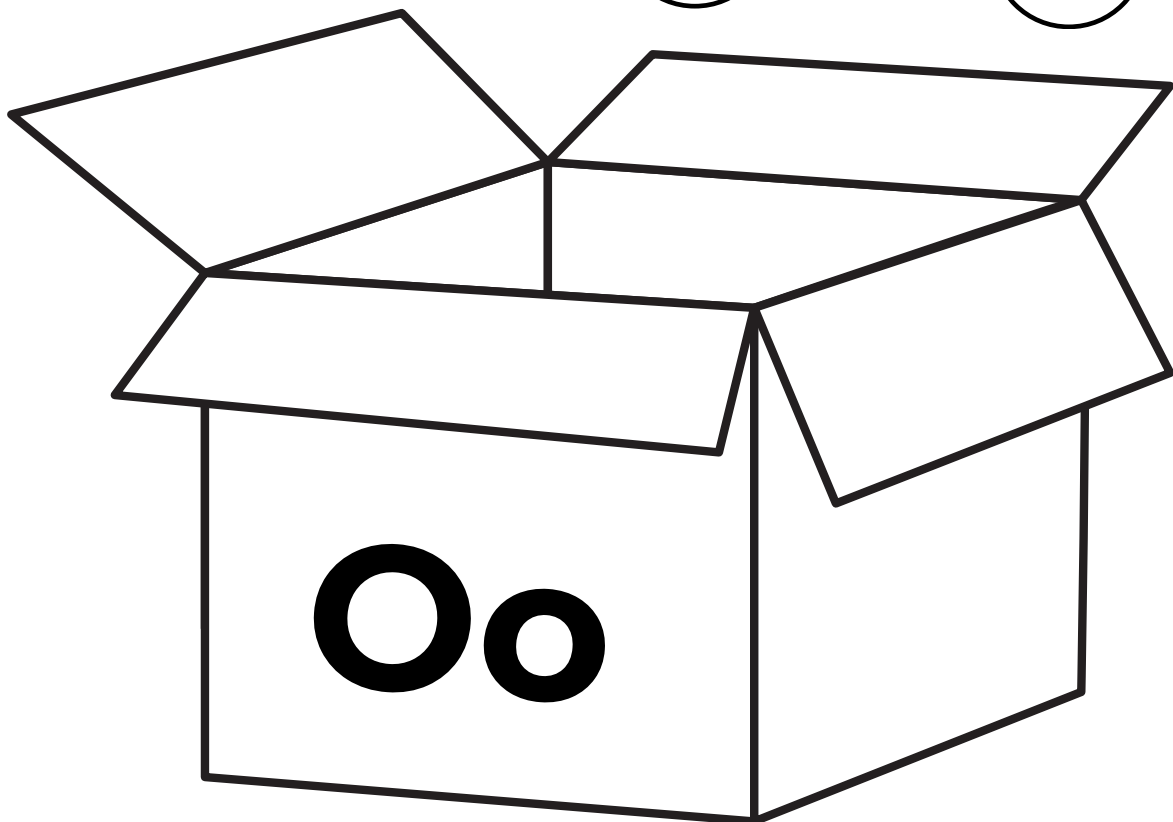
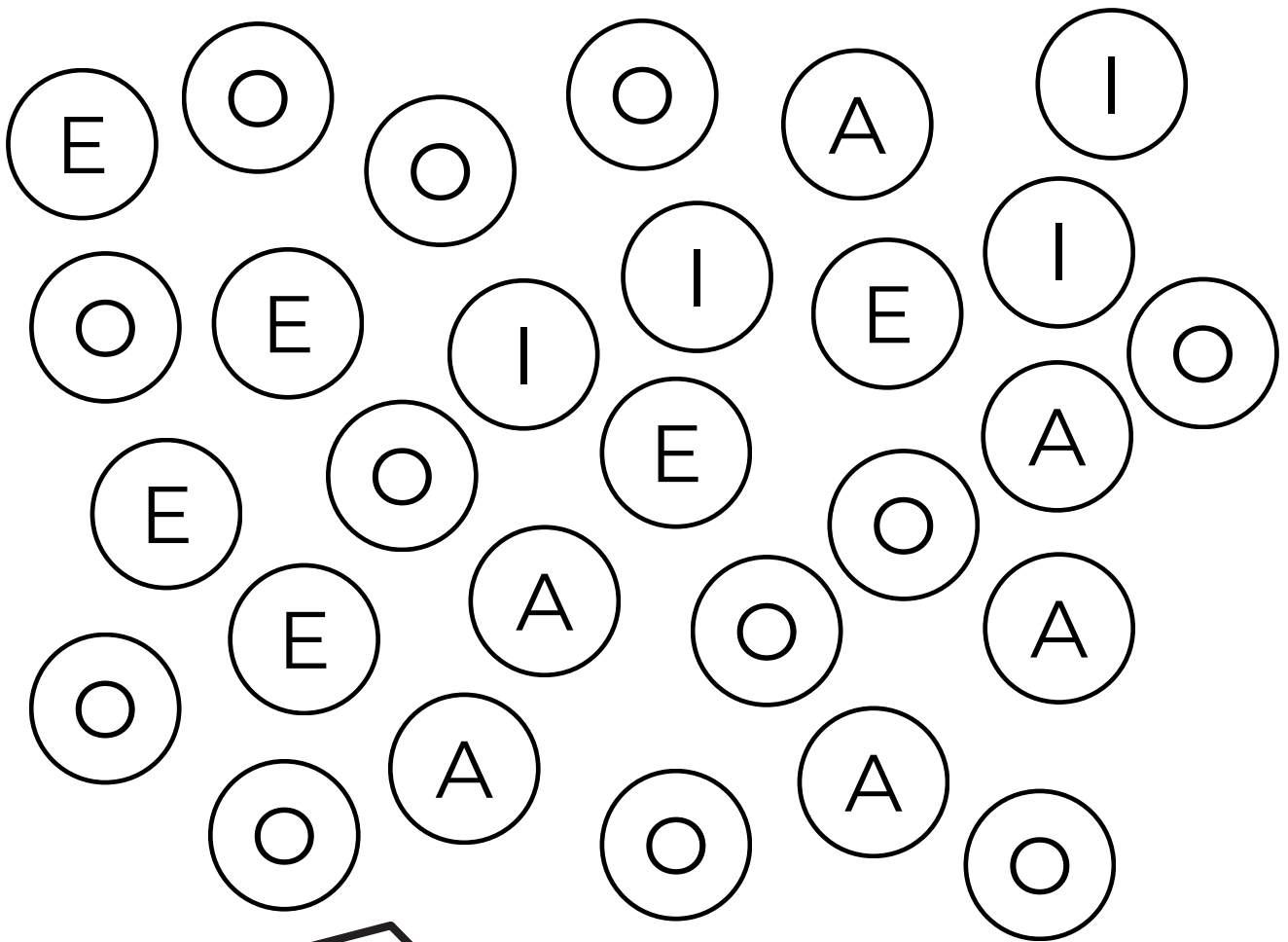

Nom _____

Date _____

Colorie la lettre o

A collection of 35 circles containing the letters 'a', 'e', 'u', and 'o' for coloring. The letters are arranged in a scattered pattern across the page.



OLIVE / olive

Nom _____

Date _____

Repasse sur la lettre P / p

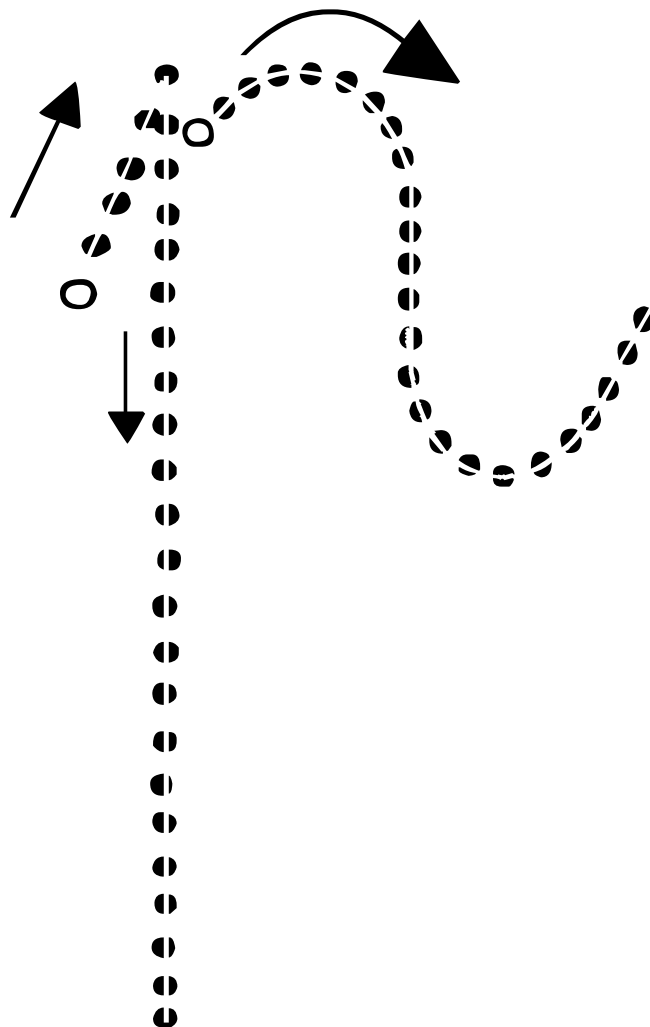

Nom _____

Date _____

Repasse sur la lettre P / p

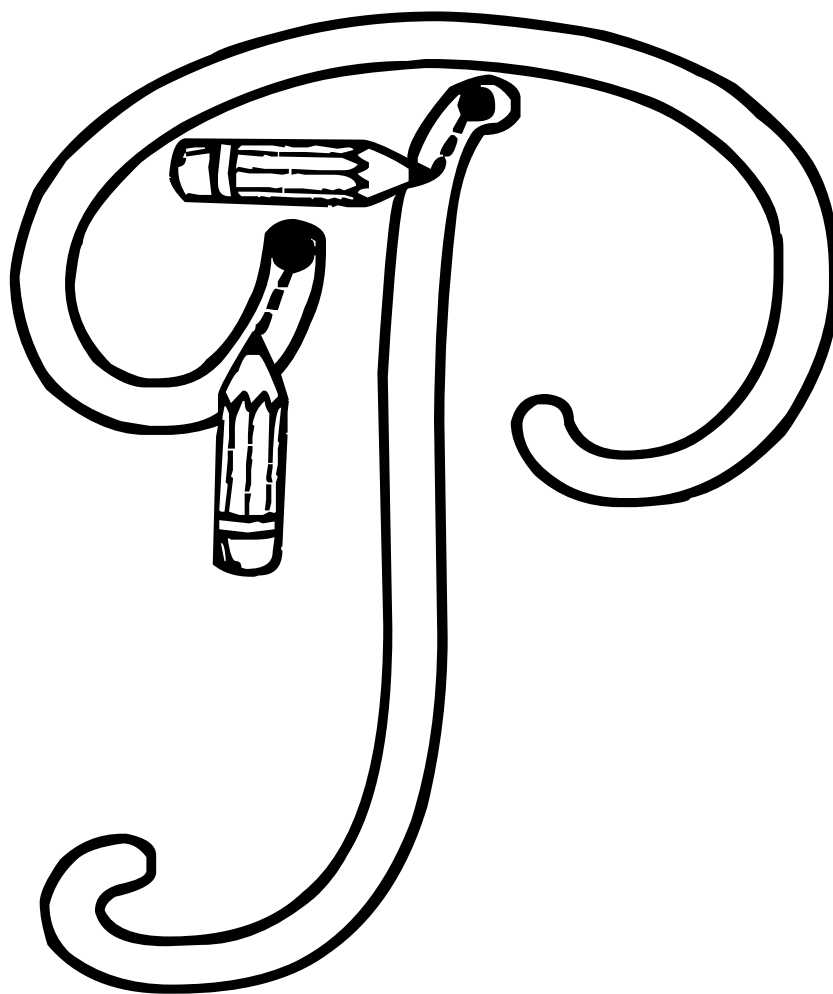

Nom _____

Date _____

Repasse sur la lettre P / p

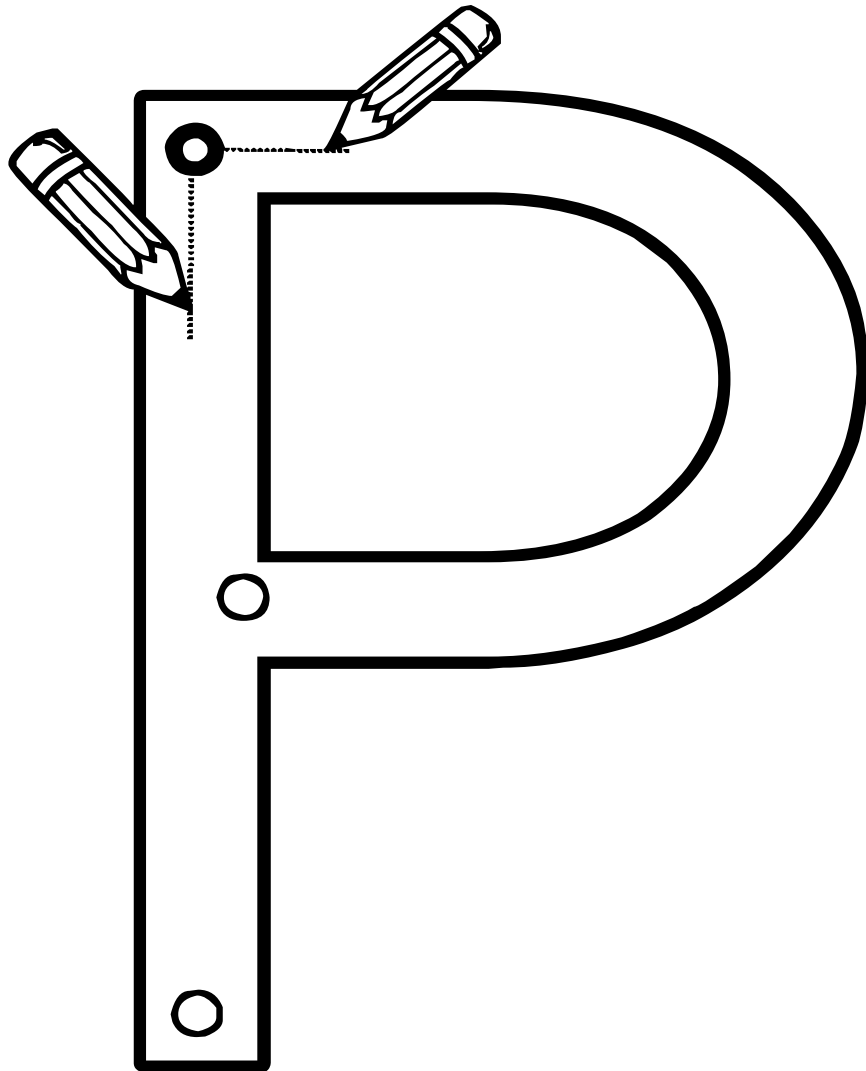

Nom _____

Date _____

Ecris la lettre P / p

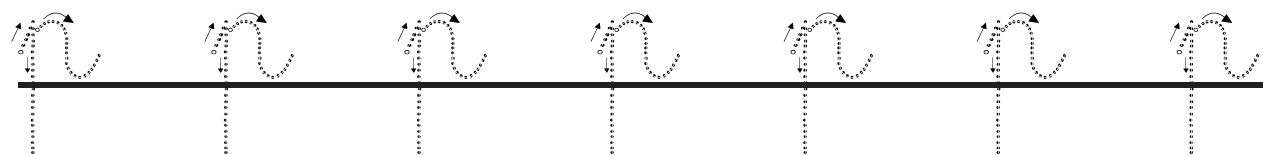
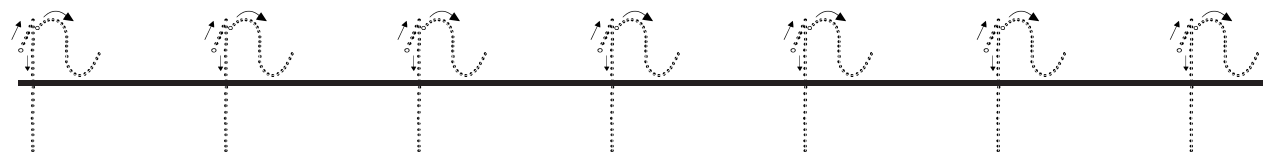
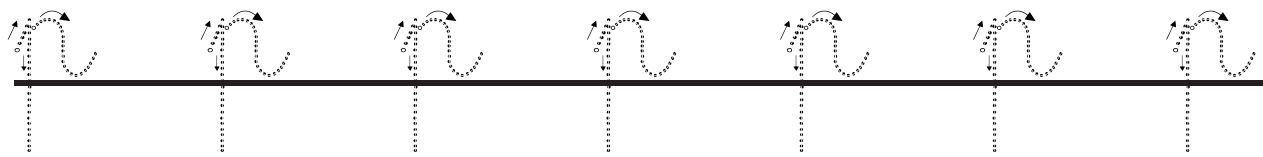
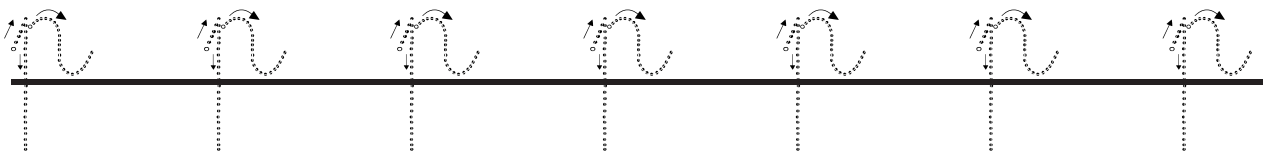
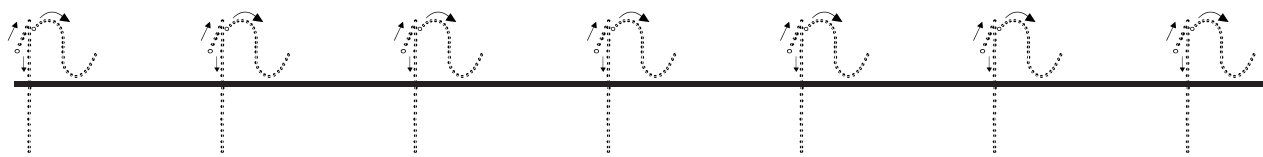
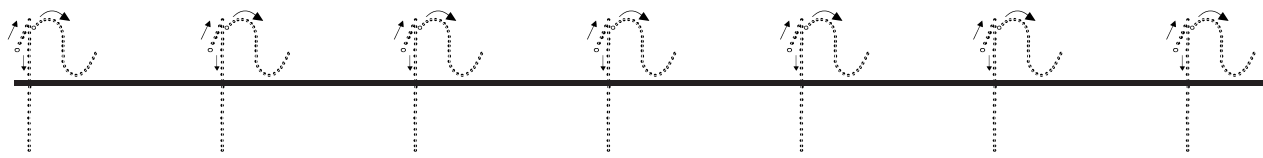
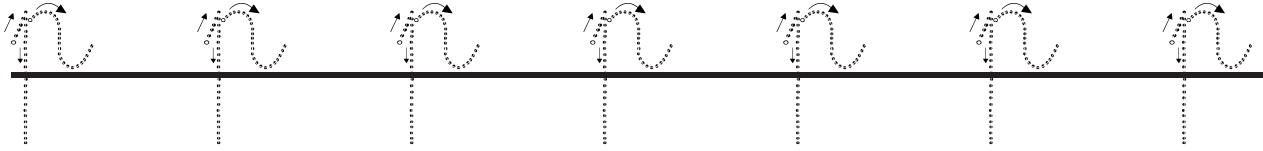

Nom _____

Date _____

Ecris la lettre P / p

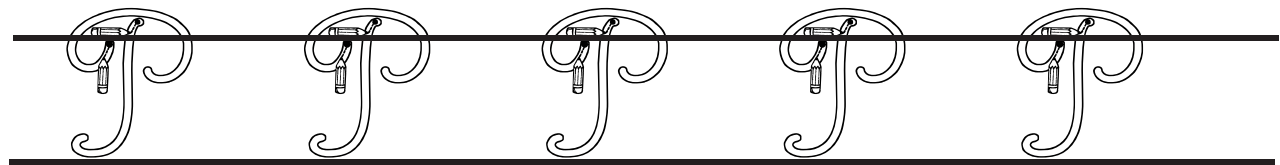
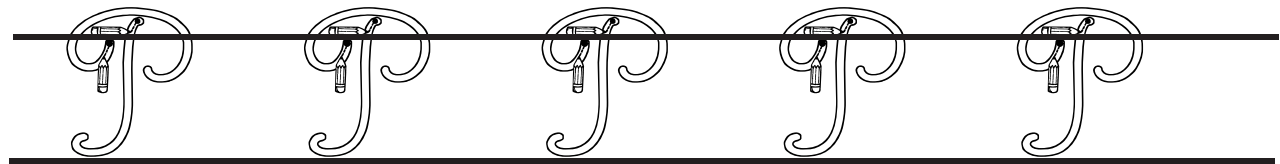
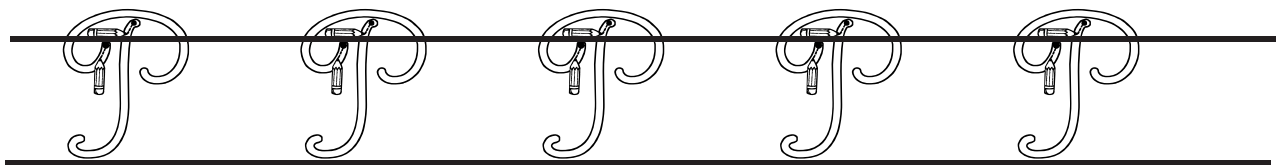
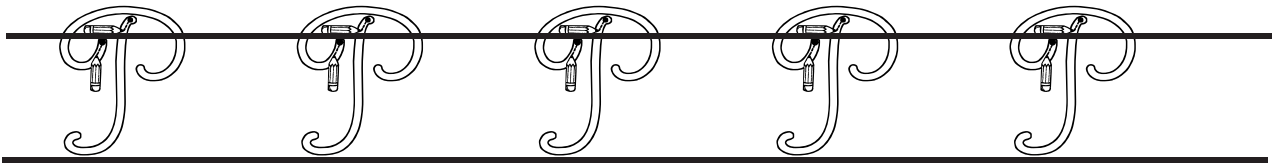
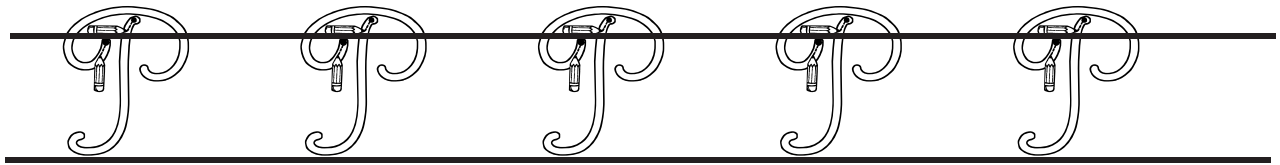
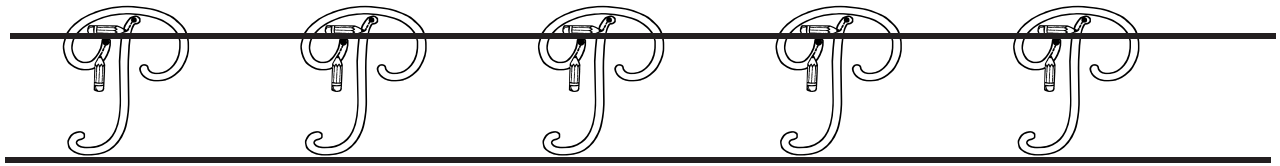
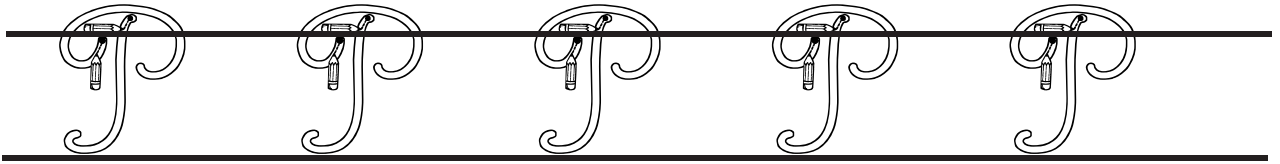

Nom _____

Date _____

Ecris la lettre P/p

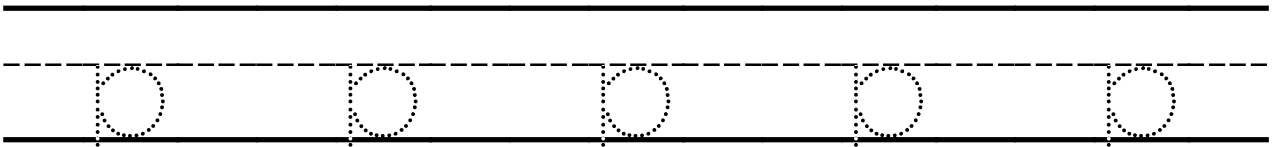
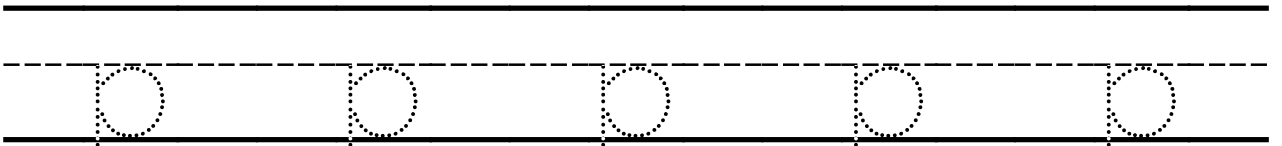
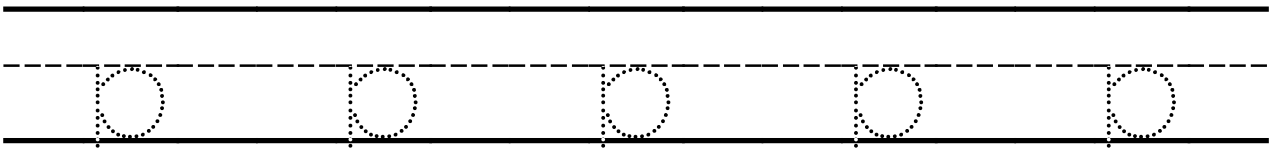
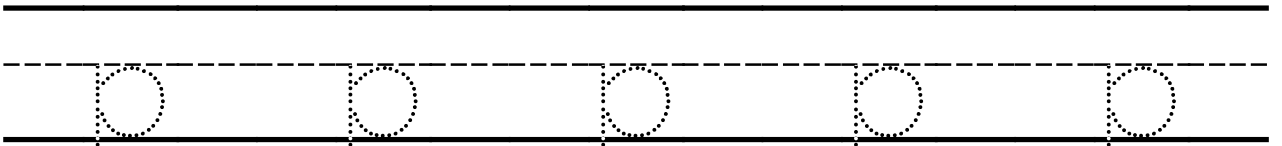
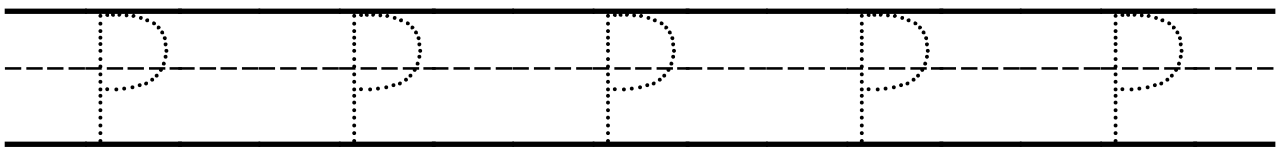
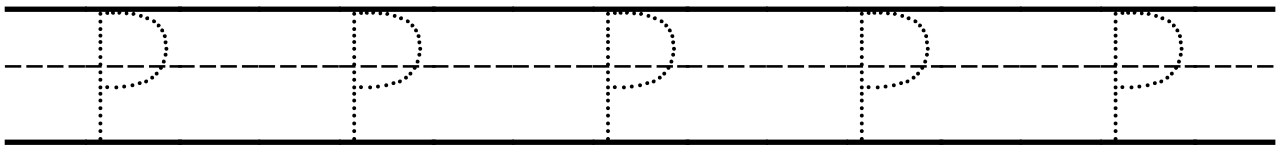
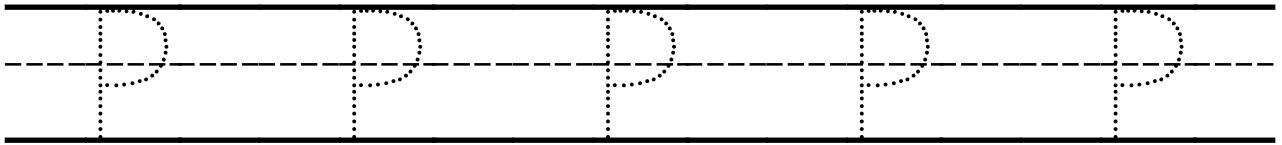
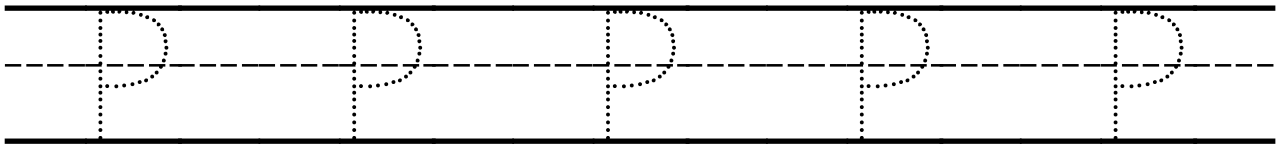

Nom _____ Date _____

Ecris la lettre P/p

P P P P P

Handwriting practice lines for uppercase letter P. The first set of lines is a solid top line, a dashed middle line, and a solid bottom line. The second set of lines is a solid top line, a dashed middle line, and a solid bottom line.

p p p p p

Handwriting practice lines for lowercase letter p. The first set of lines is a solid top line, a dashed middle line, and a solid bottom line. The second set of lines is a solid top line, a dashed middle line, and a solid bottom line.

Nom _____

Date _____

Colorie la lettre P

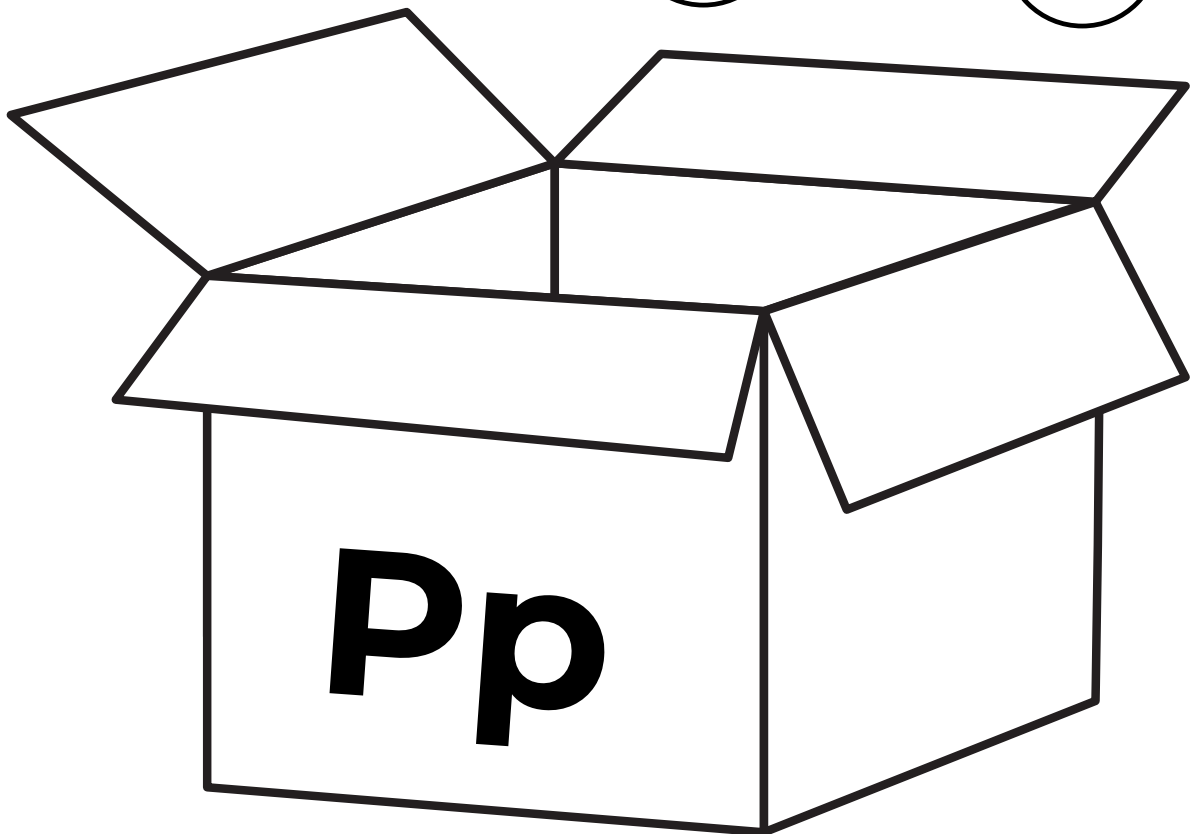
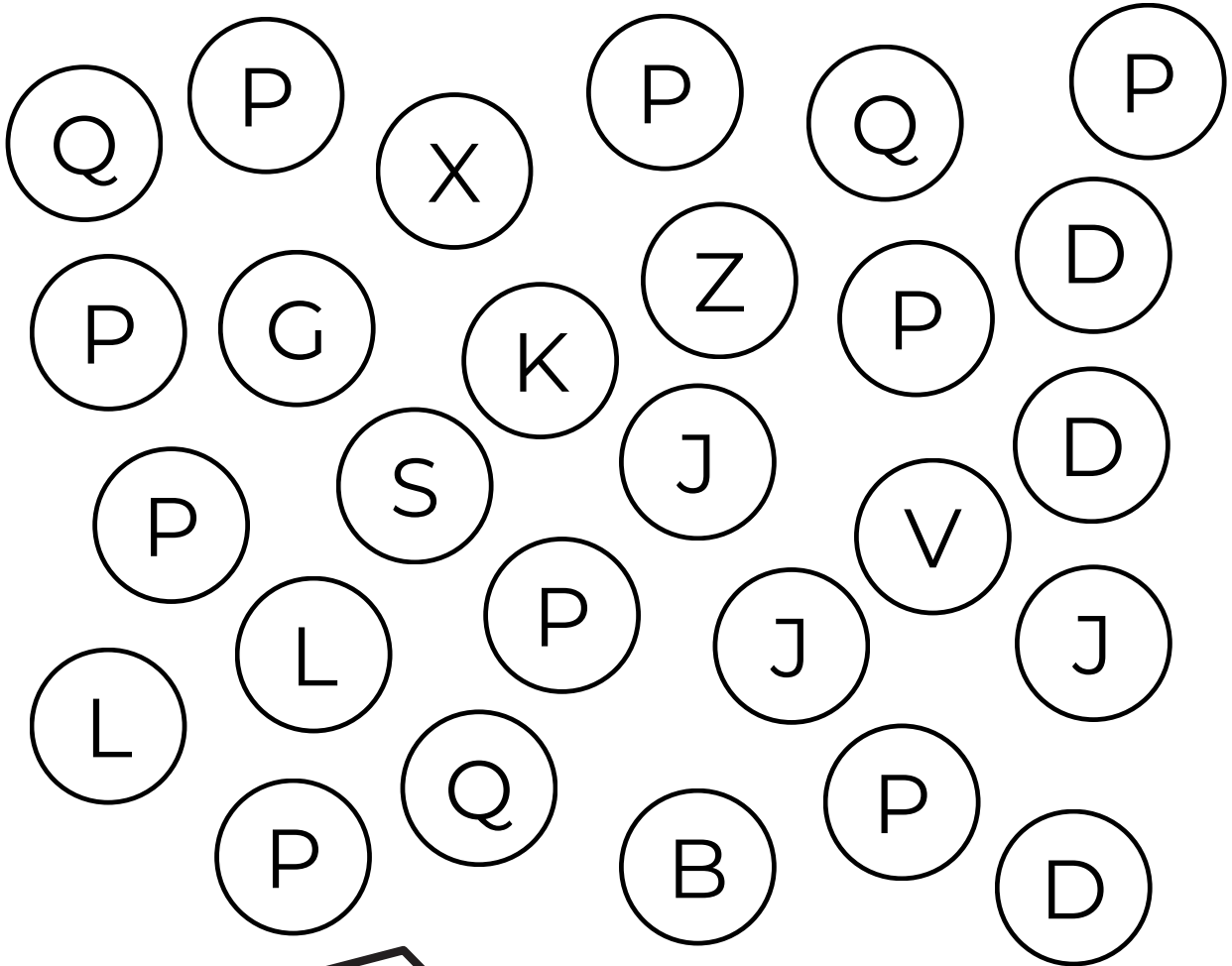

Nom _____

Date _____

Ecris la lettre p

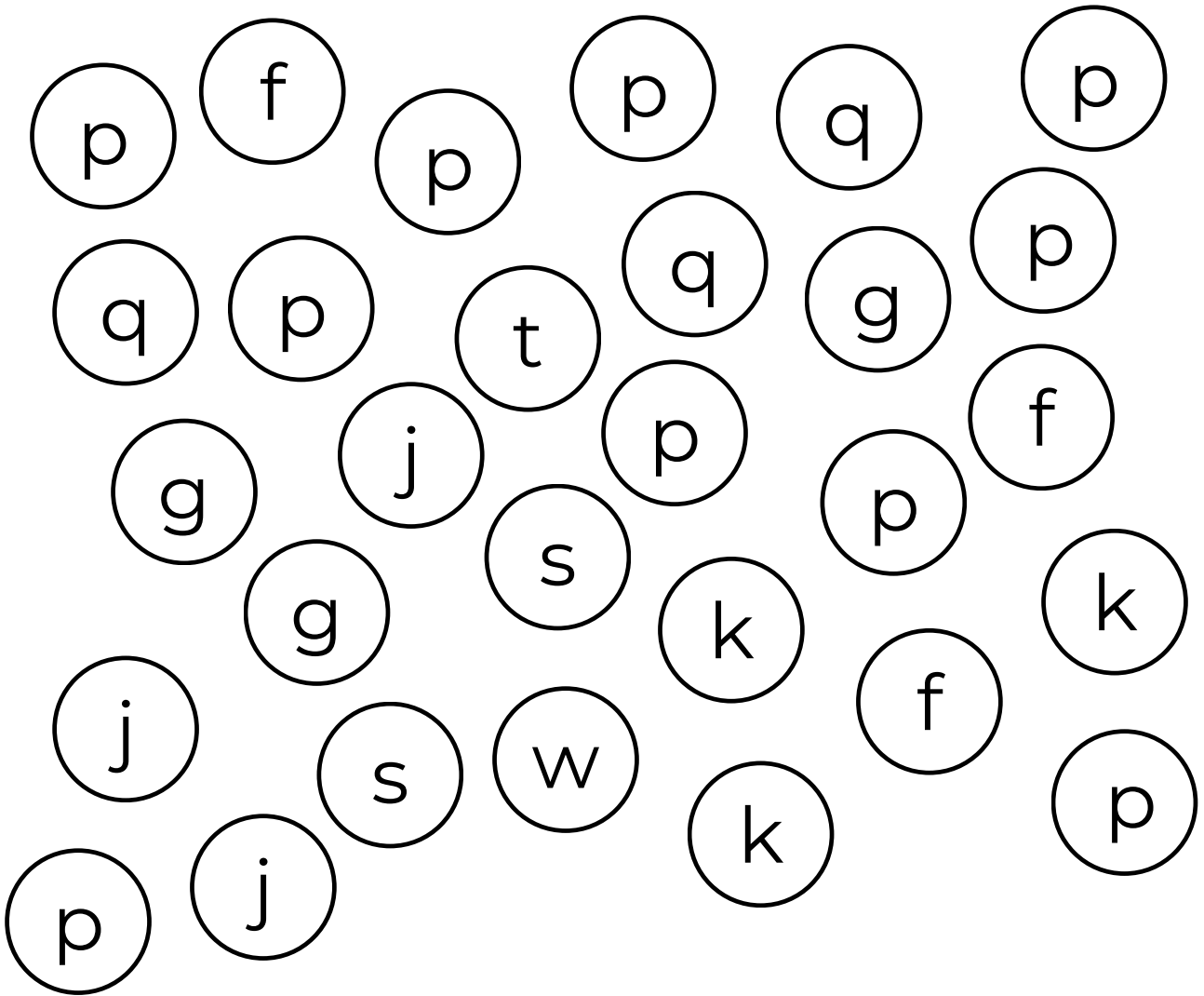

PRIERE / prière



Nom _____

Date _____

Repasse sur la lettre Q / q

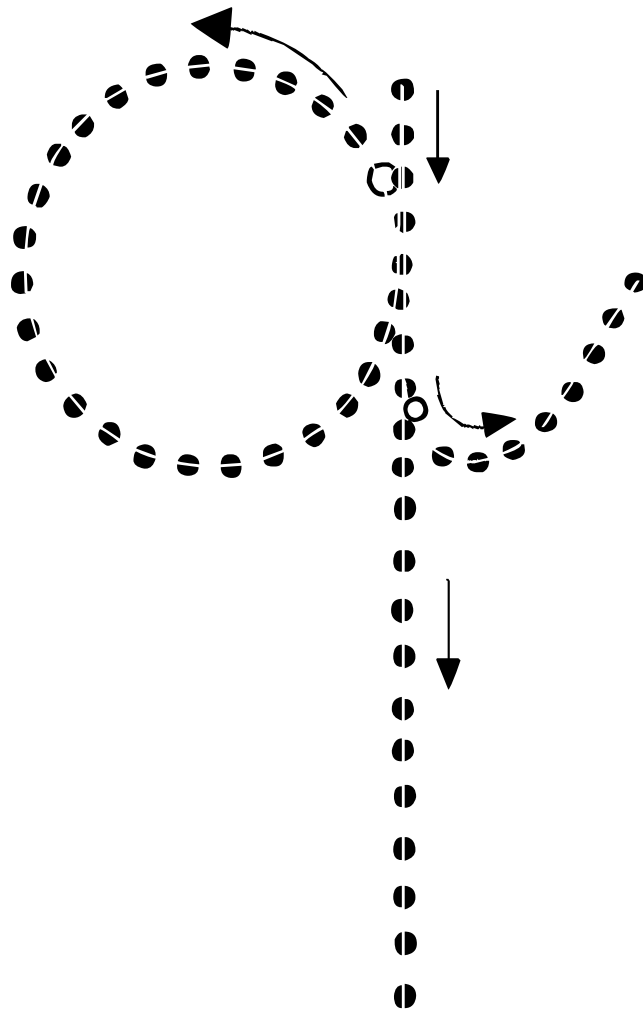

Nom _____

Date _____

Repasse sur la lettre Q / q

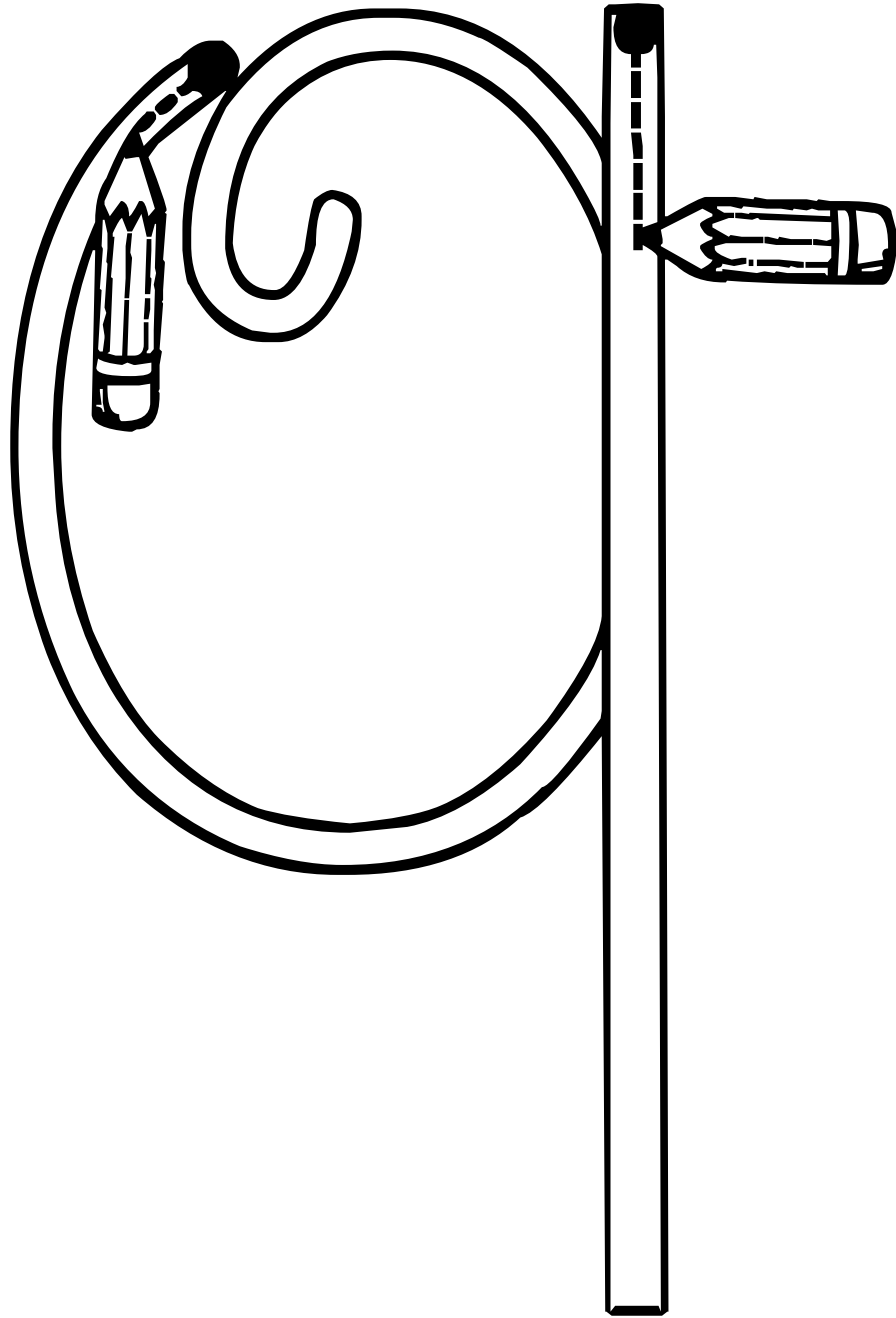

Nom _____

Date _____

Repasse sur la lettre Q / q

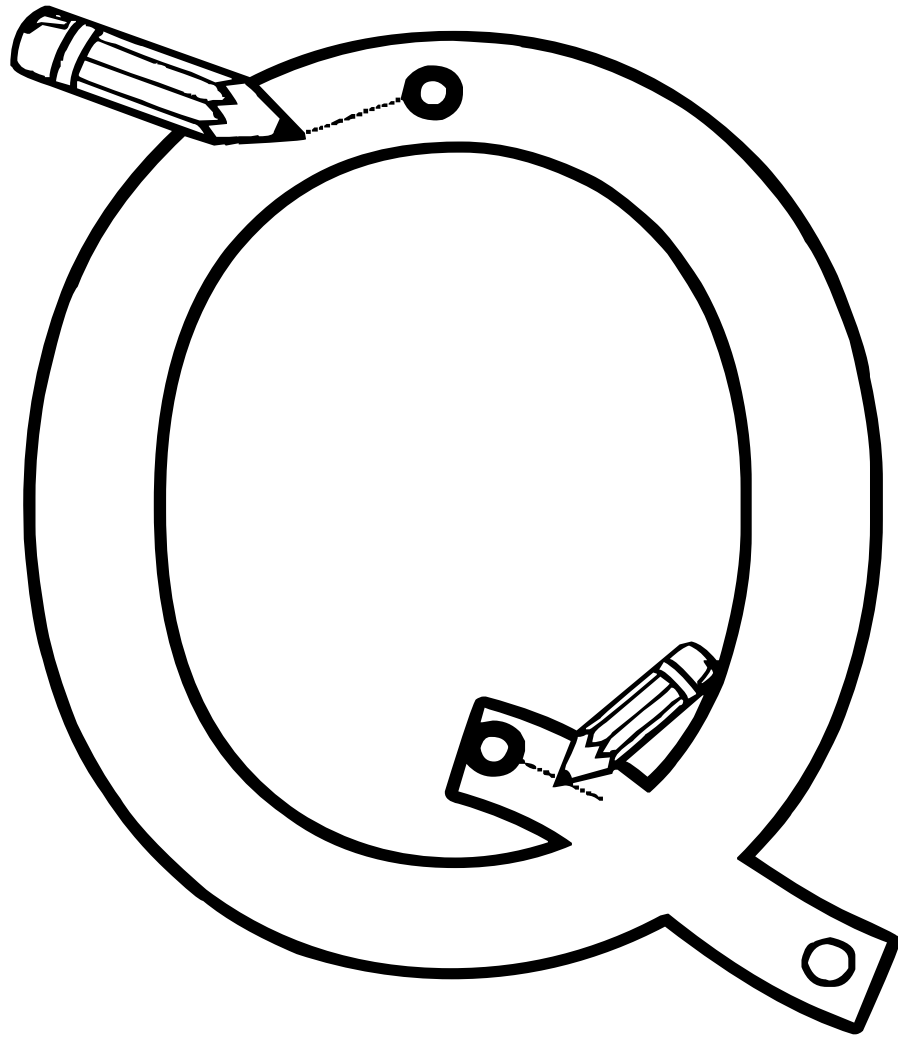

Nom _____

Date _____

Ecris la lettre Q / q

Q Q Q Q Q Q

Q Q Q Q Q Q

Q Q Q Q Q Q

Q Q Q Q Q Q

Q Q Q Q Q Q

Q Q Q Q Q Q

Q Q Q Q Q Q

Nom _____

Date _____

Ecris la lettre R / r

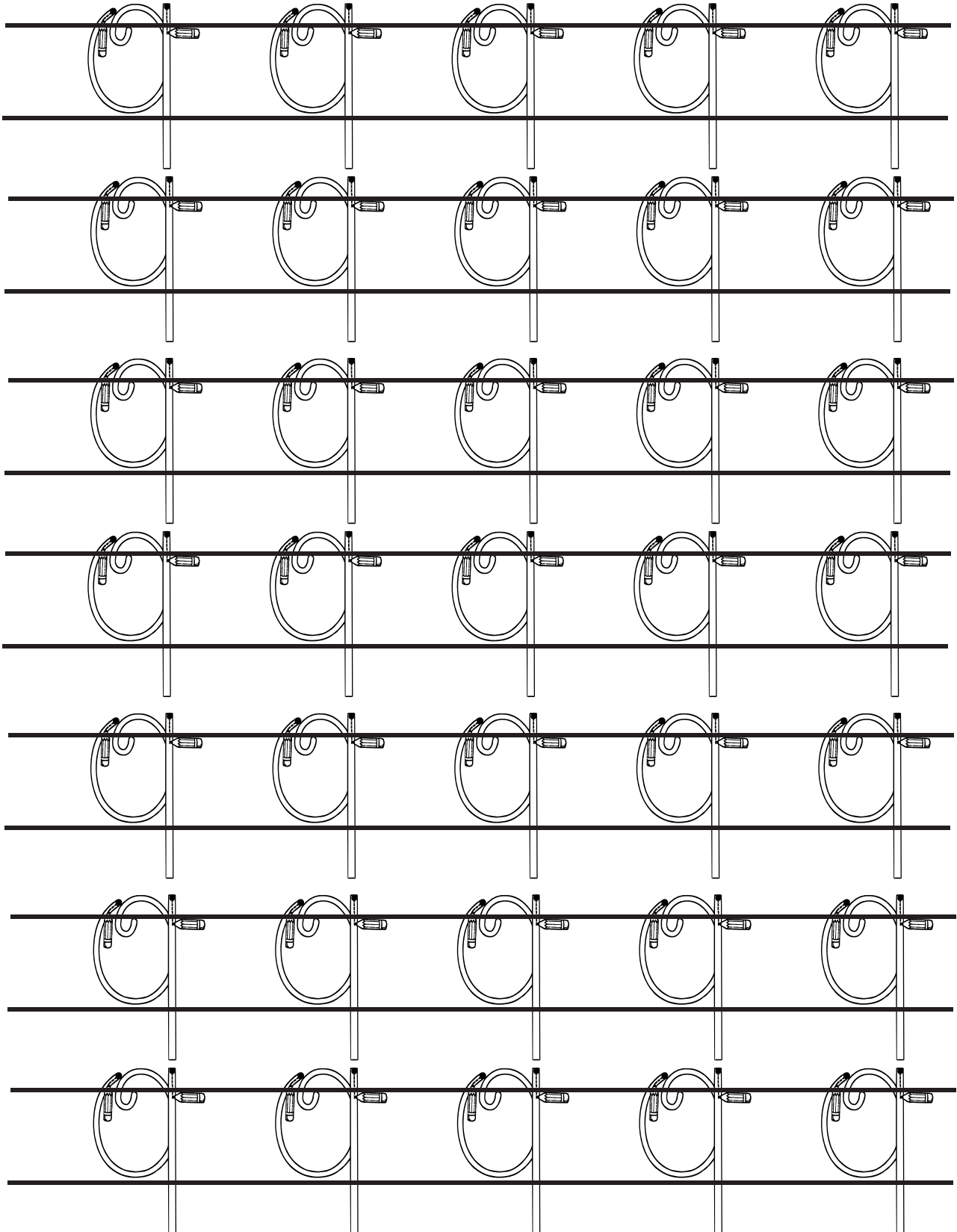

Nom _____

Date _____

Ecris la lettre Q/q

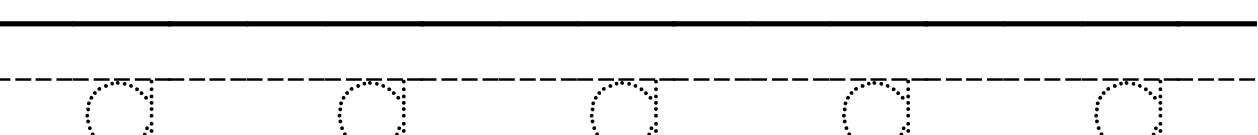
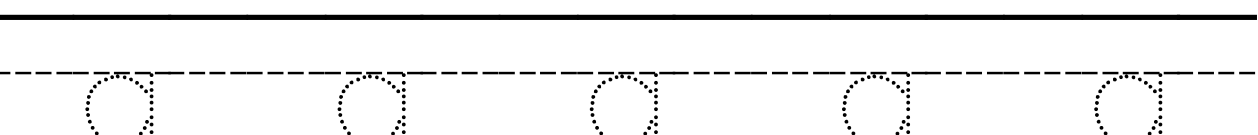
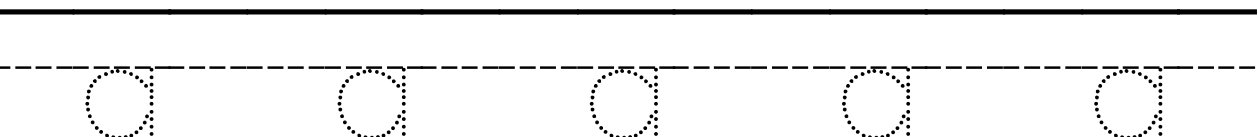
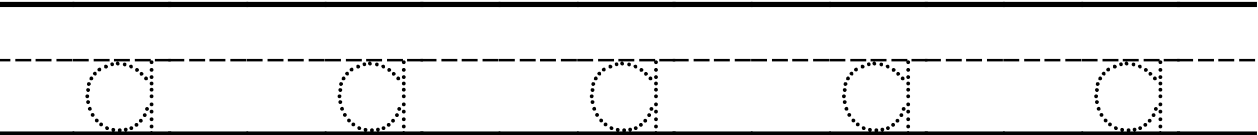
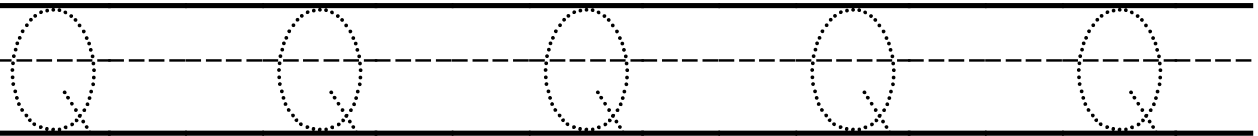
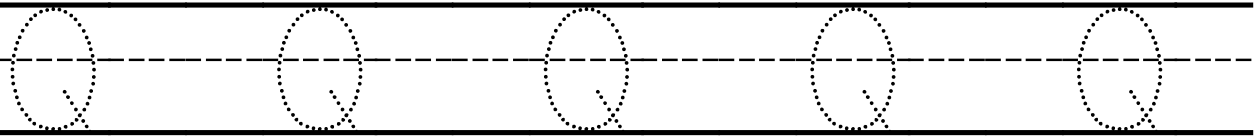
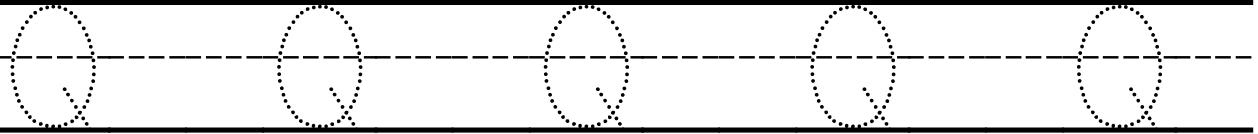
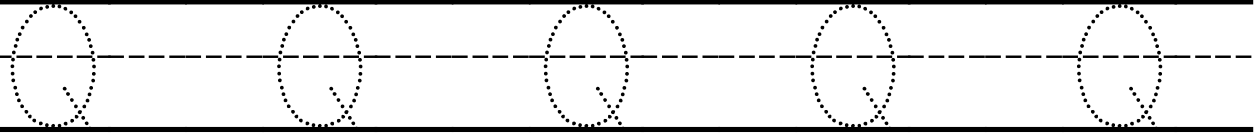

Nom _____ Date _____

Ecris la lettre Q/q

Q Q Q Q Q

Handwriting practice lines for uppercase Q. The first row contains five examples of the letter Q. Below are two sets of blank handwriting lines, each consisting of a solid top line, a dashed middle line, and a solid bottom line.

q q q q q

Handwriting practice lines for lowercase q. The first row contains five examples of the letter q. Below are two sets of blank handwriting lines, each consisting of a solid top line, a dashed middle line, and a solid bottom line.

Nom _____

Date _____

Colorie la lettre Q

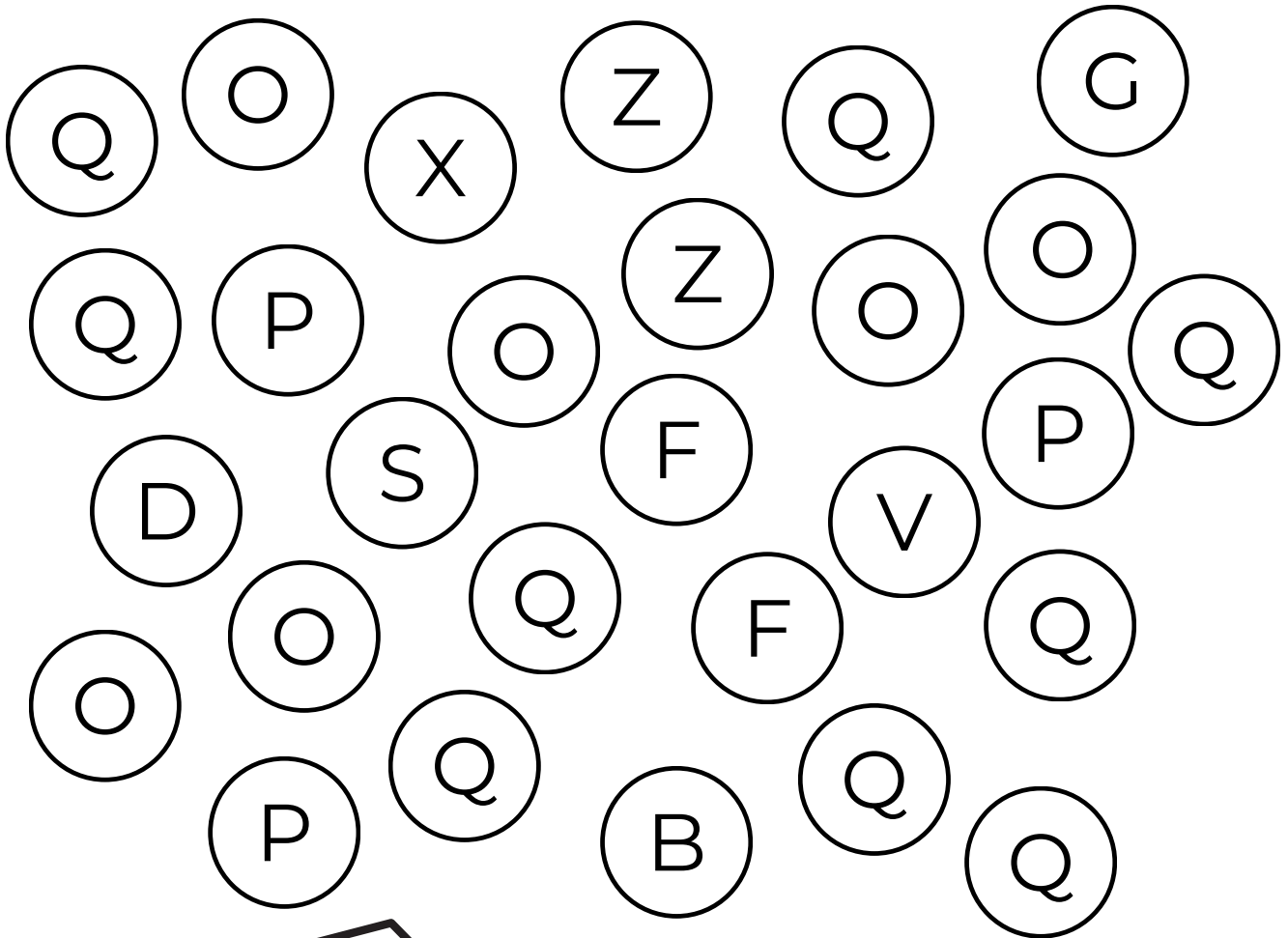

Nom _____

Date _____

Colorie la lettre q

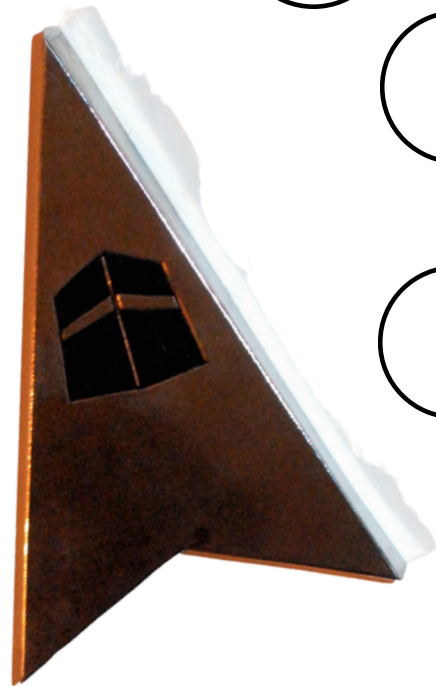
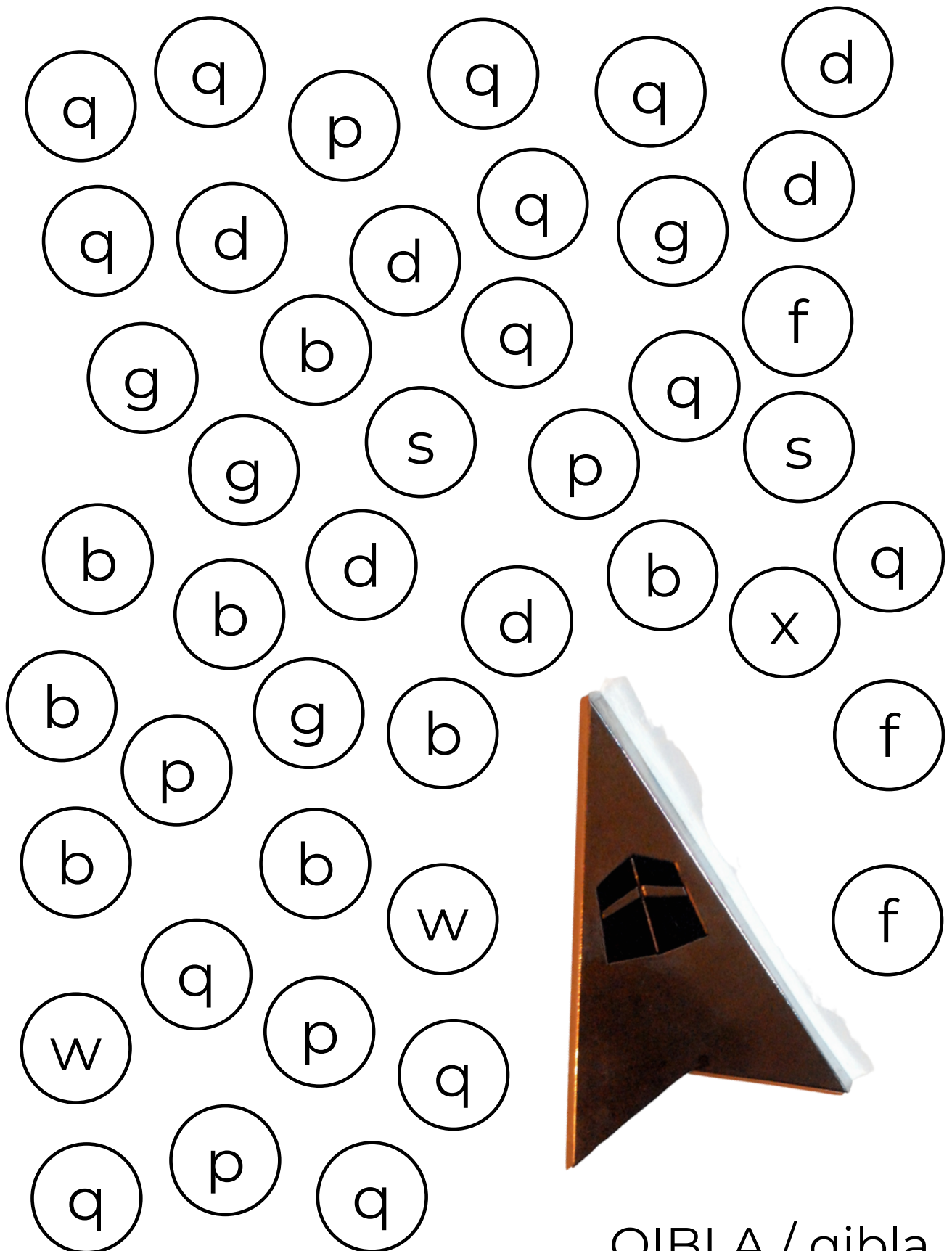

QIBLA / qibla

Nom _____

Date _____

Repasse sur la lettre R / r

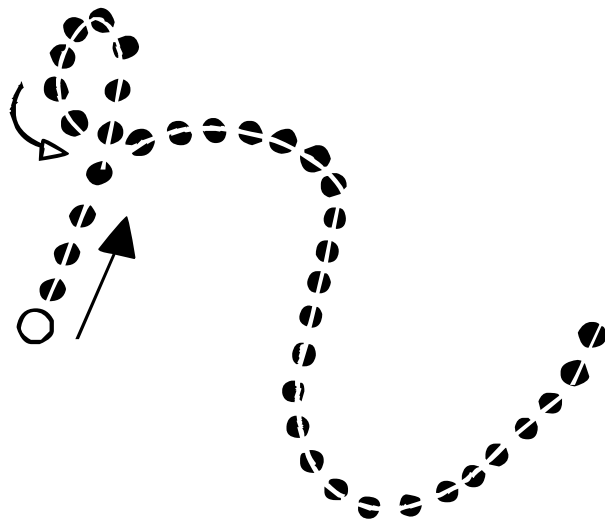

Nom _____

Date _____

Repasse sur la lettre R / r

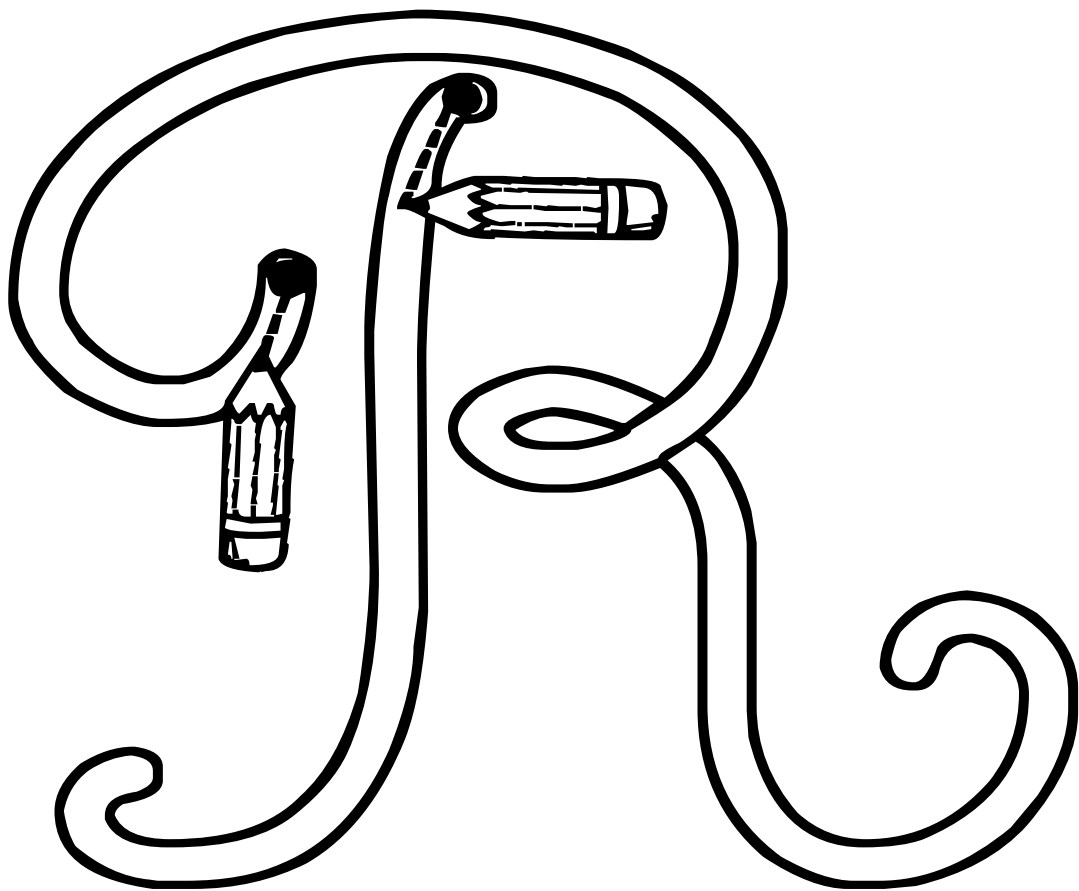

Nom _____

Date _____

Repasse sur la lettre R / r

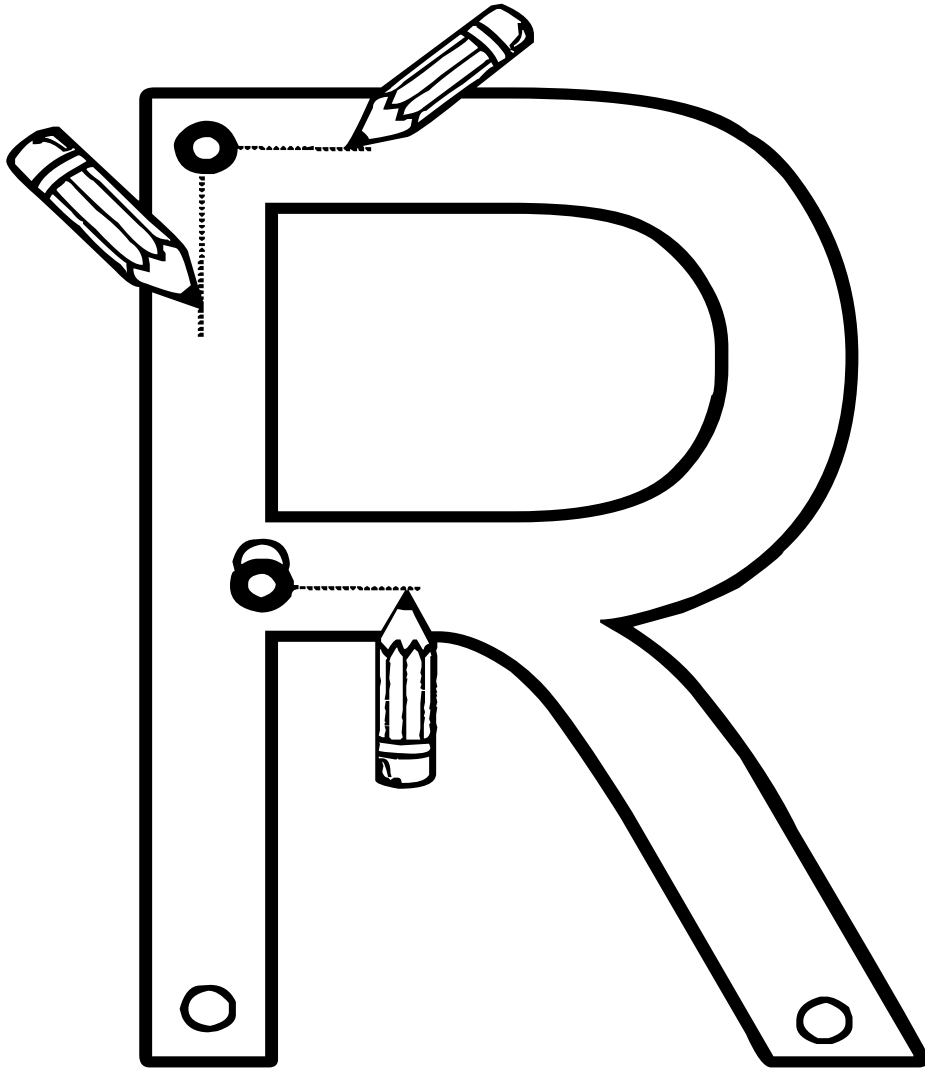

Nom _____

Date _____

Ecris la lettre R / r

R R R R R R R

R R R R R R R

R R R R R R R

R R R R R R R

R R R R R R R

R R R R R R R

R R R R R R R

Nom _____

Date _____

Ecris la lettre R / r

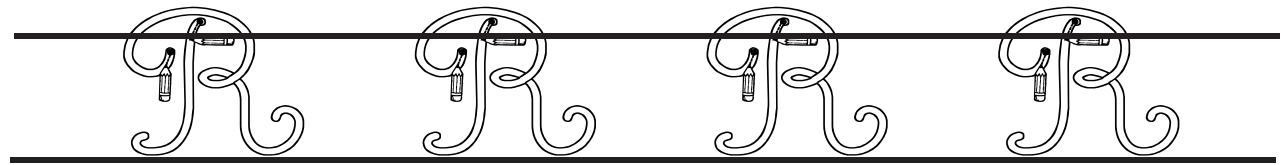
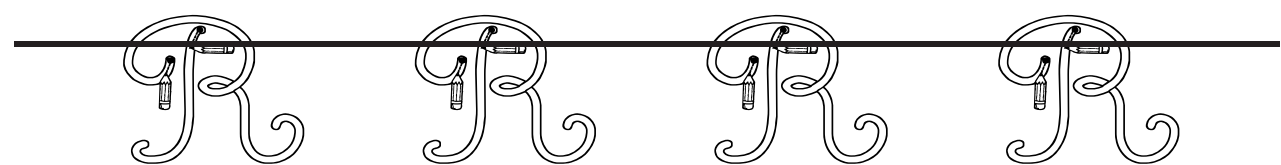
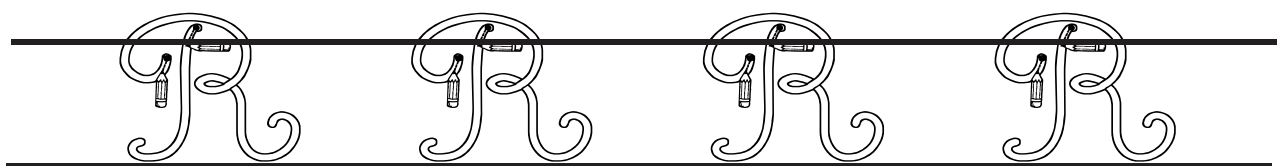
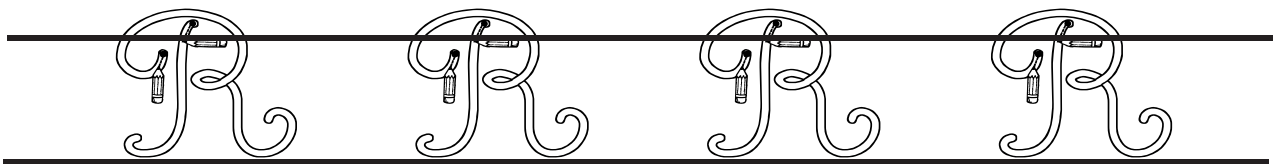
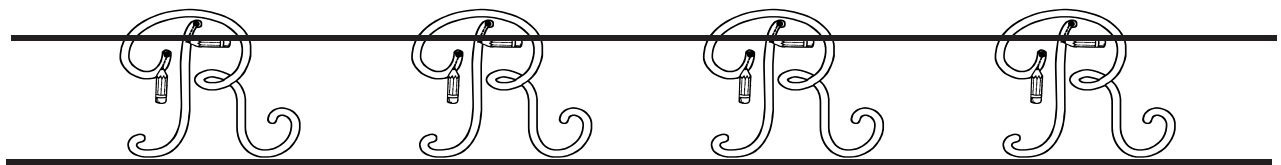
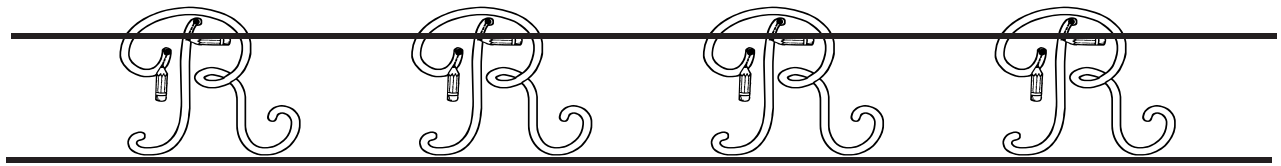
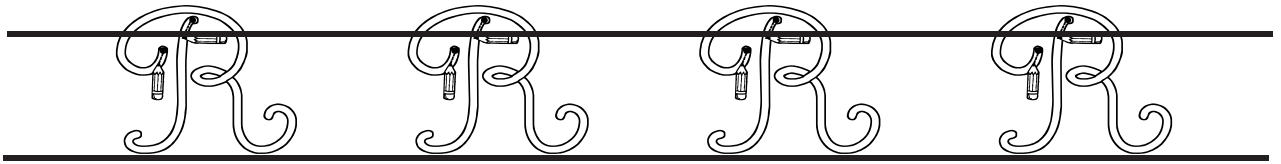

Nom _____

Date _____

Ecris la lettre R/r

R R R R R

R R R R R

R R R R R

R R R R R

r r r r r

r r r r r

r r r r r

r r r r r

r r r r r

Nom _____ Date _____

Ecris la lettre R/r

R R R R R

Handwriting practice lines for uppercase letter R. Each set consists of a solid top line, a dashed middle line, and a solid bottom line. There are two such sets of lines provided for practice.

r r r r r

Handwriting practice lines for lowercase letter r. Each set consists of a solid top line, a dashed middle line, and a solid bottom line. There are two such sets of lines provided for practice.

Nom _____

Date _____

Colorie la lettre R

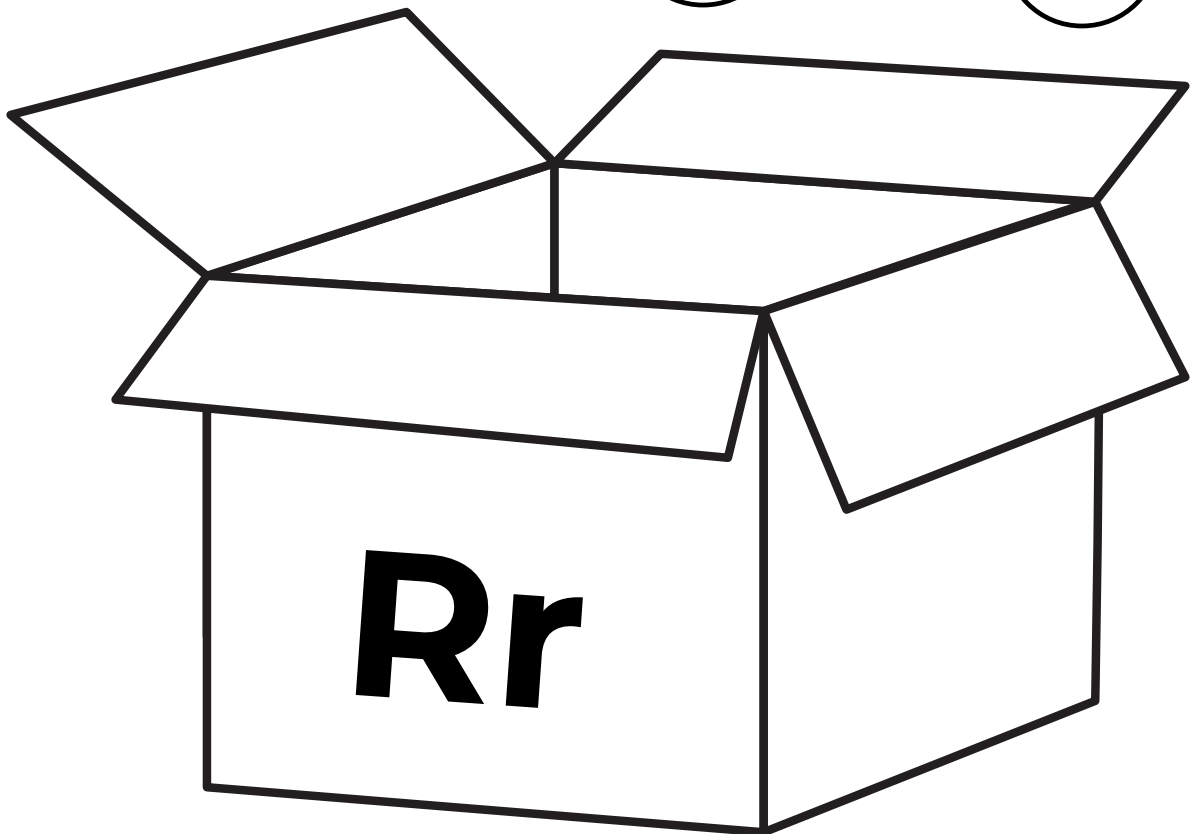
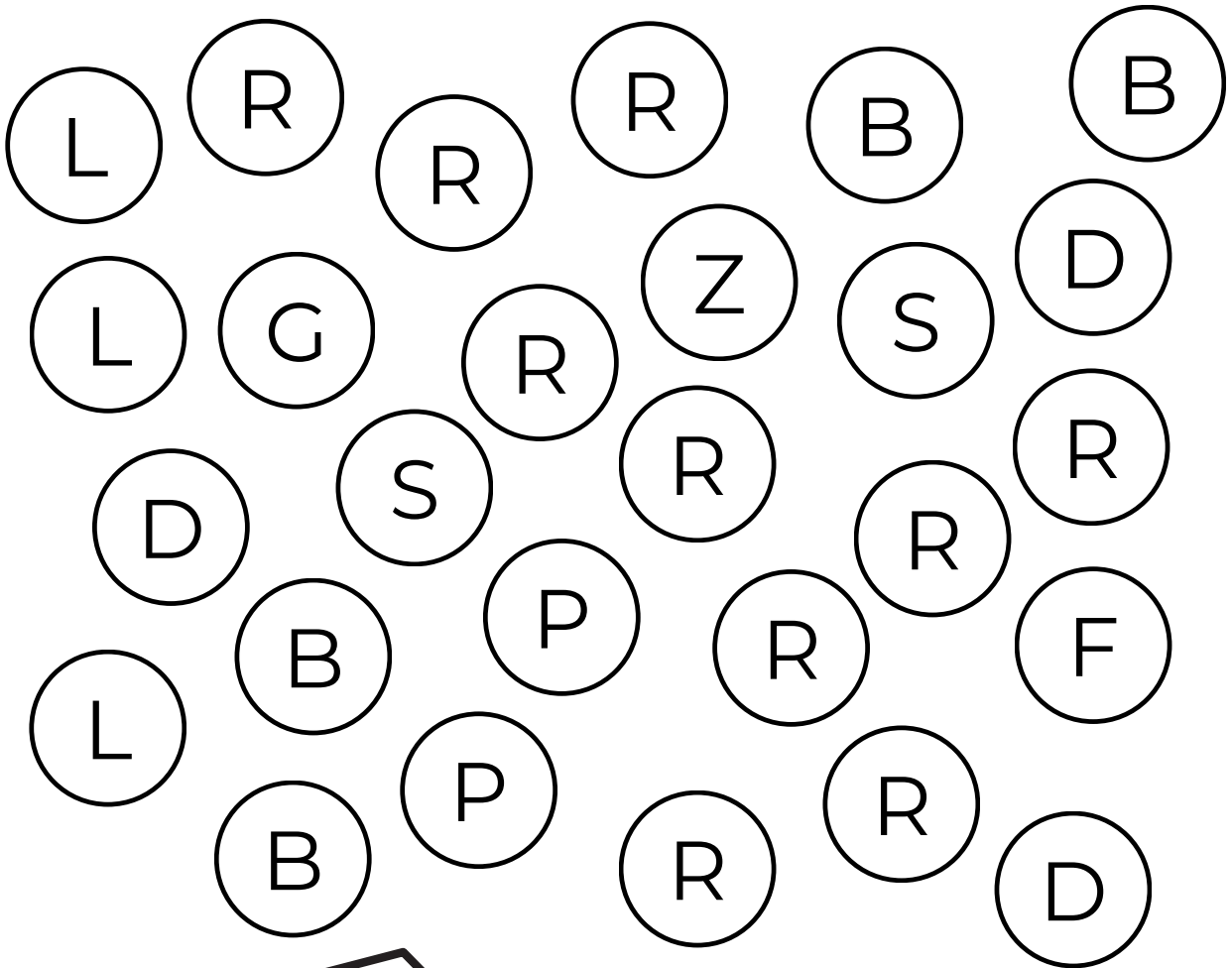

Nom _____

Date _____

Colorie la lettre r

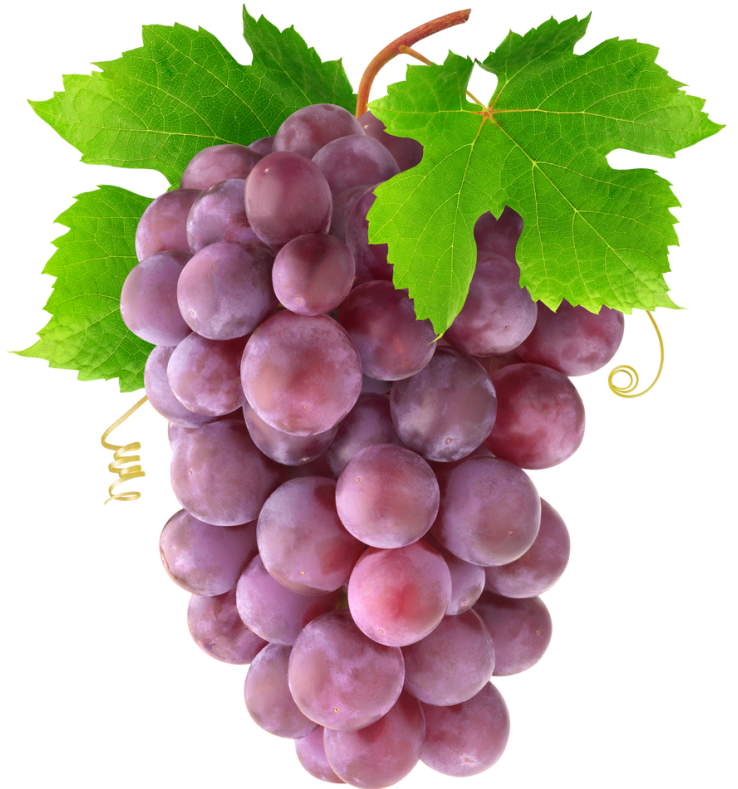
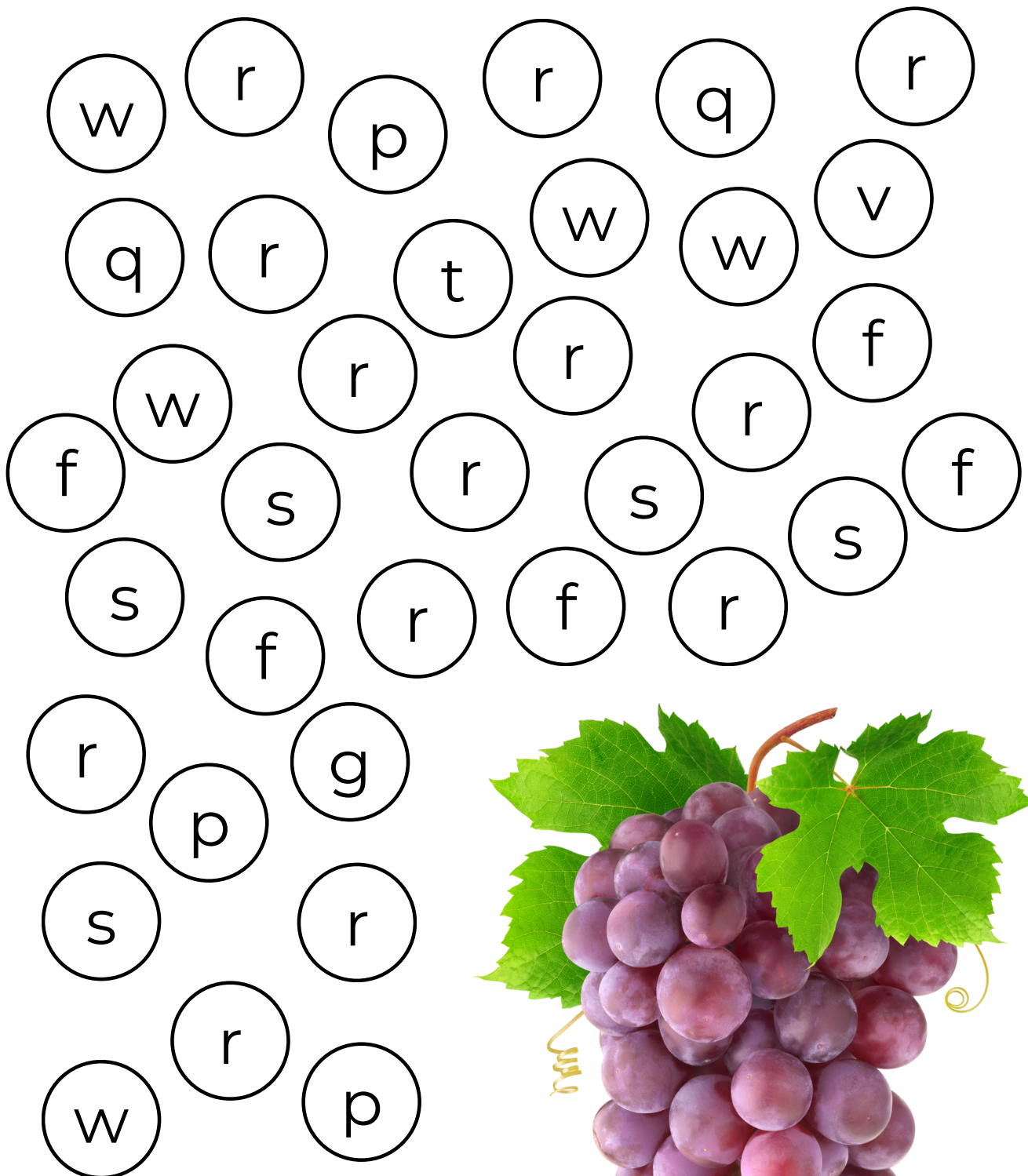

RAISIN / raisin

Nom _____

Date _____

Repasse sur la lettre S / s

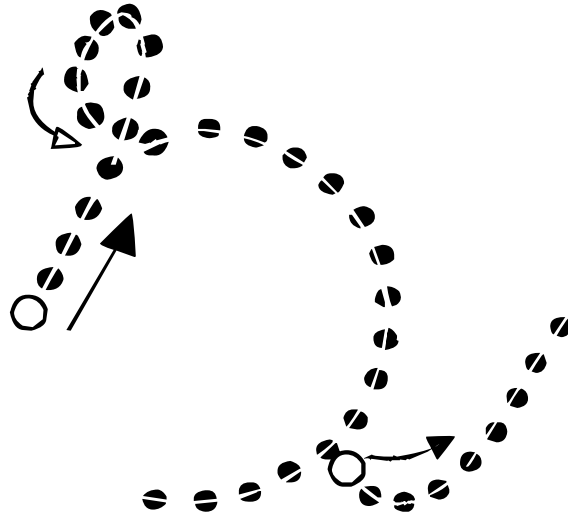

Nom _____

Date _____

Repasse sur la lettre S / s

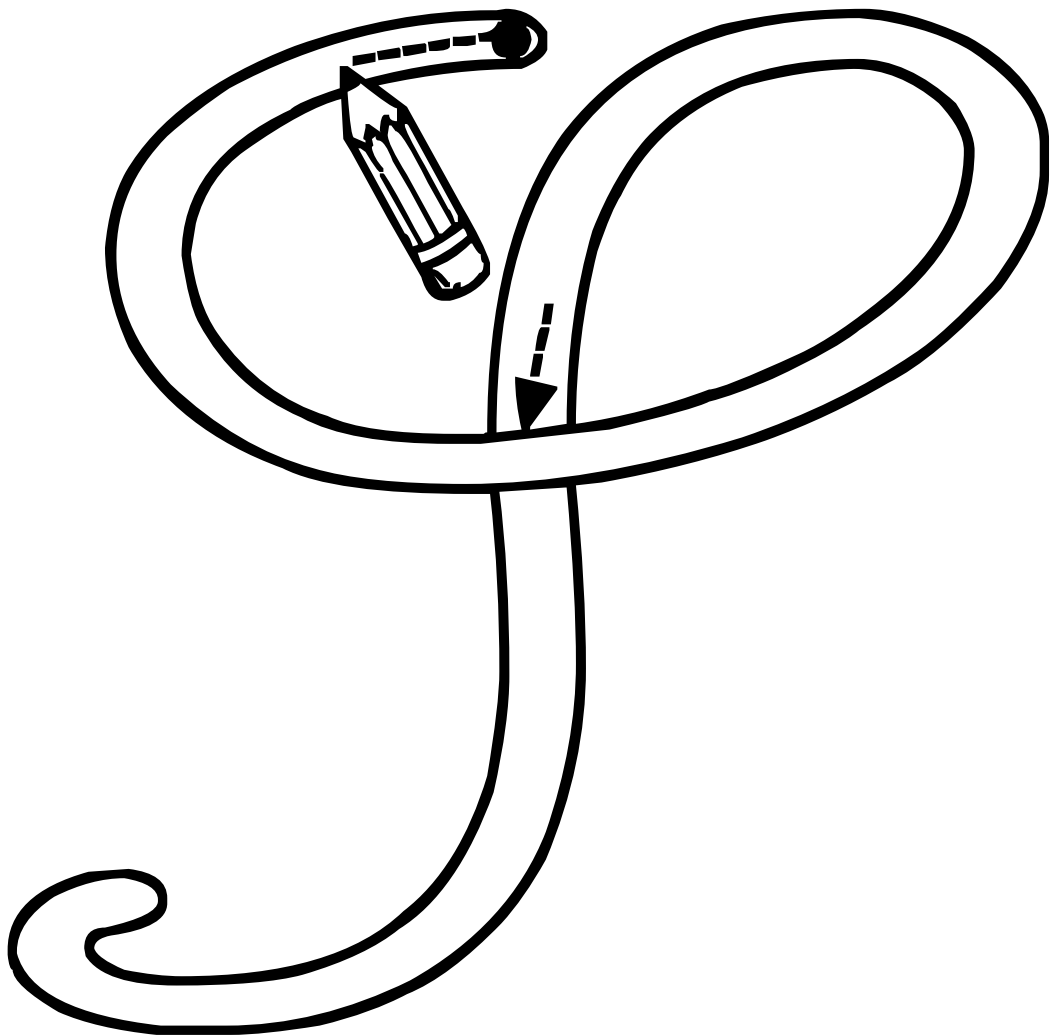

Nom _____

Date _____

Repasse sur la lettre S / s

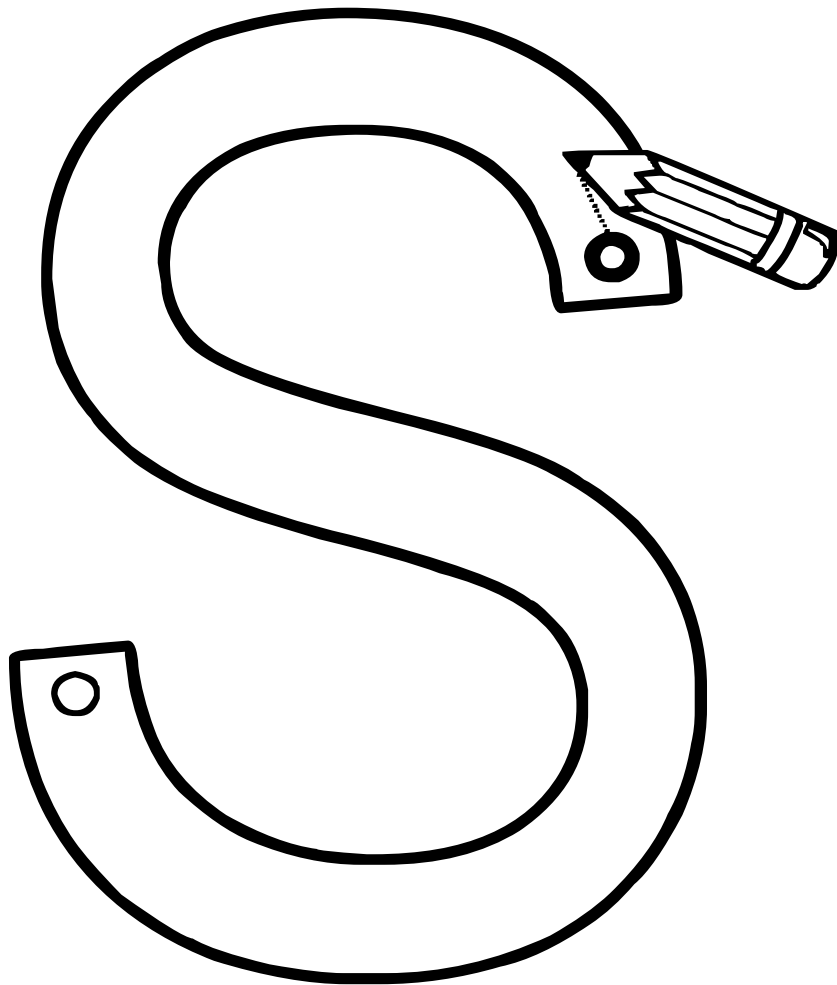

Nom _____

Date _____

Ecris la lettre S / s



Nom _____

Date _____

Ecris la lettre S / s

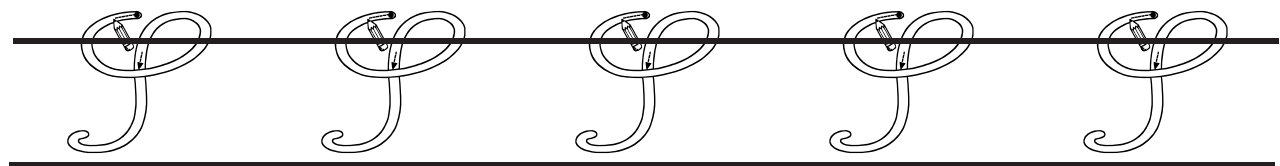
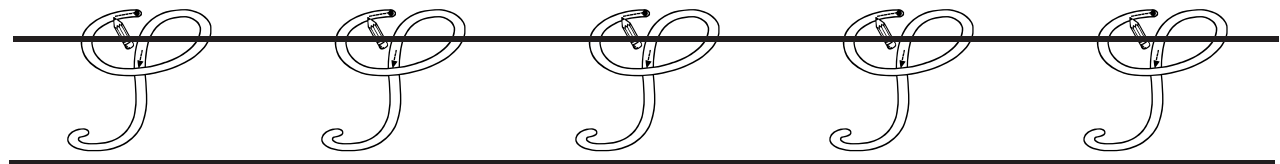
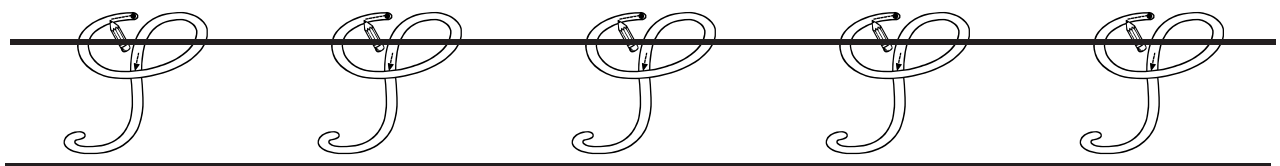
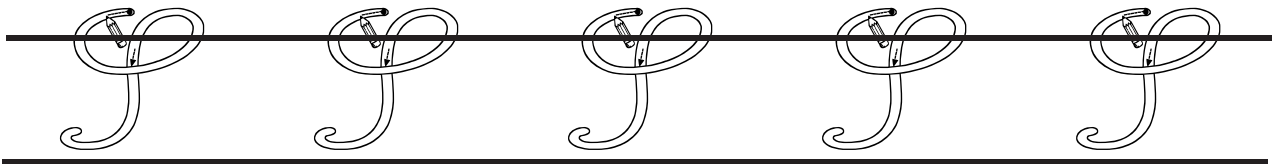
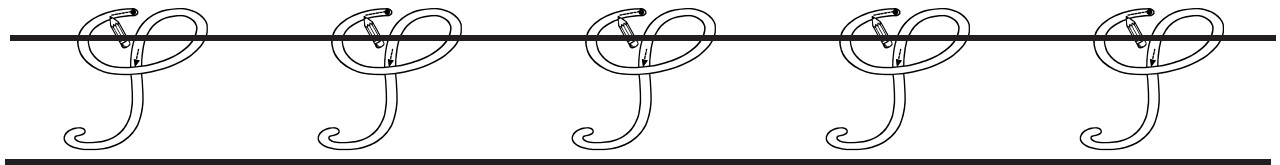
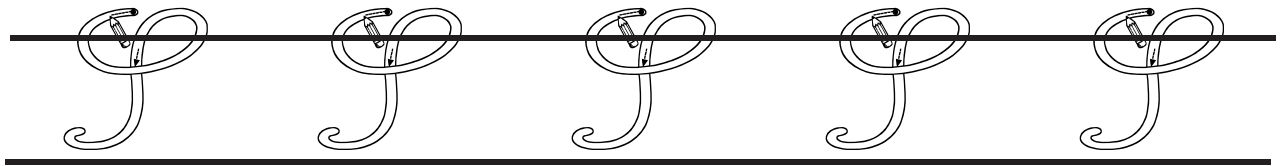
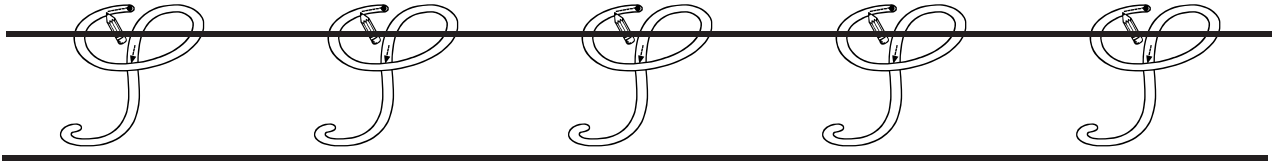

Nom _____ Date _____

Ecris la lettre S/s

S S S S S

S S S S S

S S S S S

S S S S S

s s s s s

s s s s s

s s s s s

s s s s s

Nom _____ Date _____

Ecris la lettre S/s

S S S S S

Handwriting practice lines for uppercase 'S'. Each row consists of a solid top line, a dashed middle line, and a solid bottom line. There are two such rows provided for practice.

s s s s s

Handwriting practice lines for lowercase 's'. Each row consists of a solid top line, a dashed middle line, and a solid bottom line. There are two such rows provided for practice.

Nom _____

Date _____

Colorie la lettre S

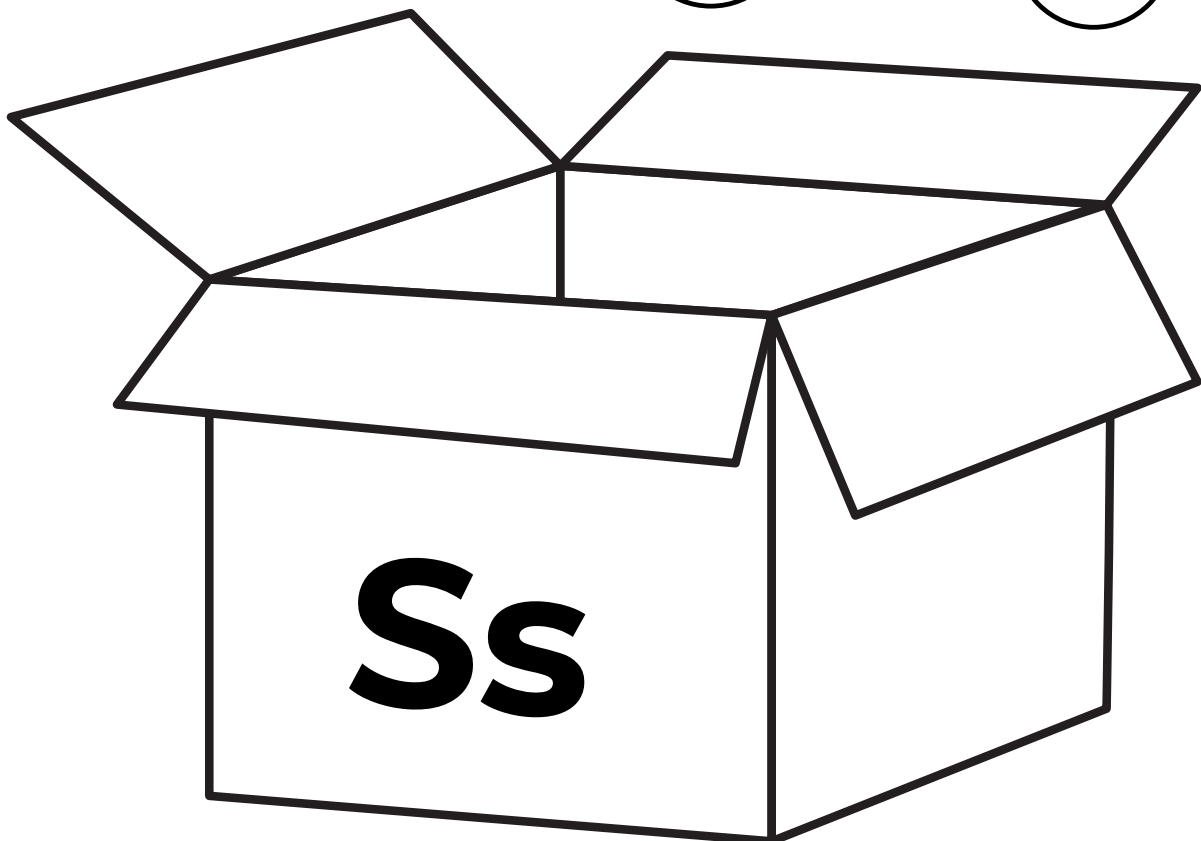
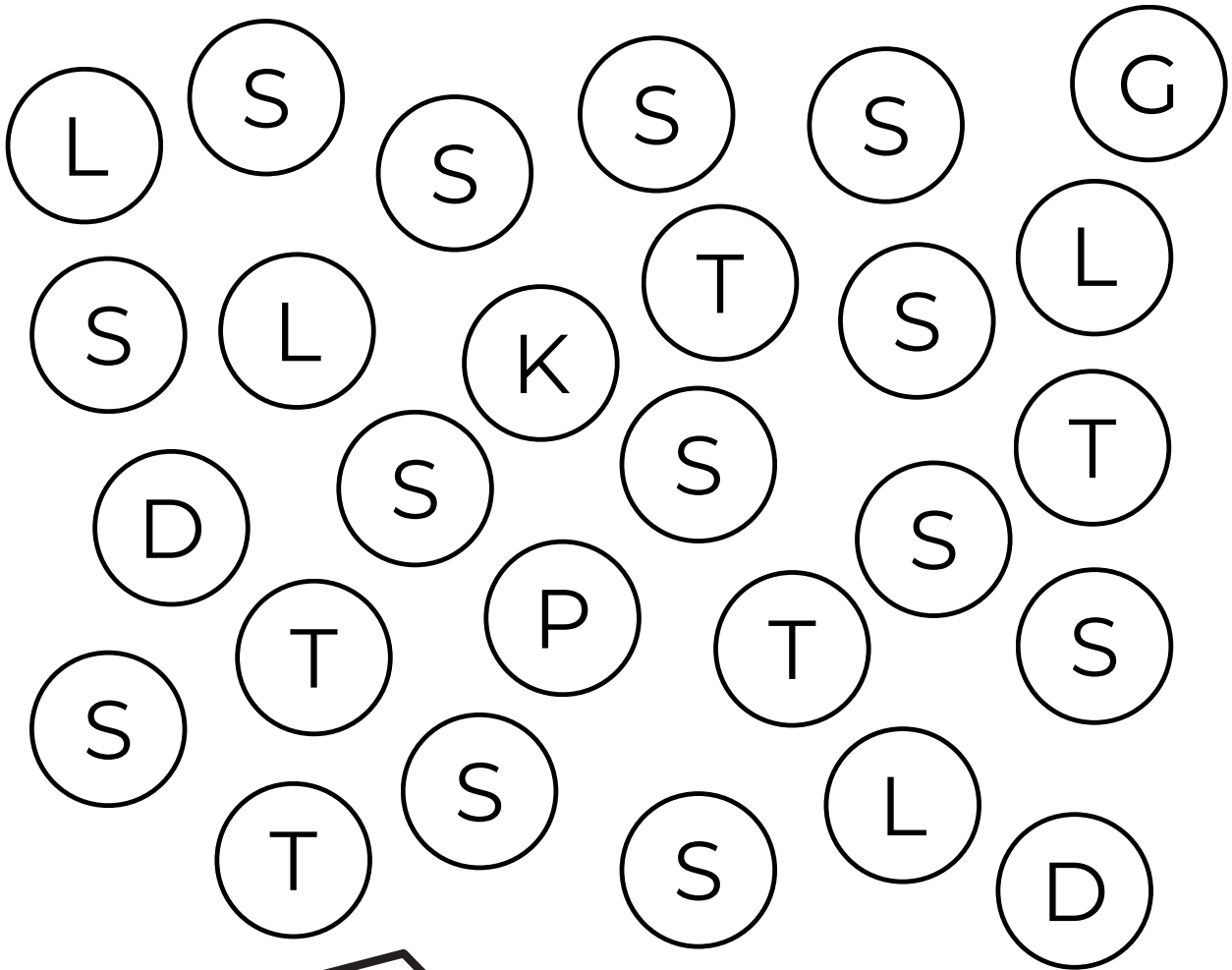

Nom _____

Date _____

Colorie la lettre s

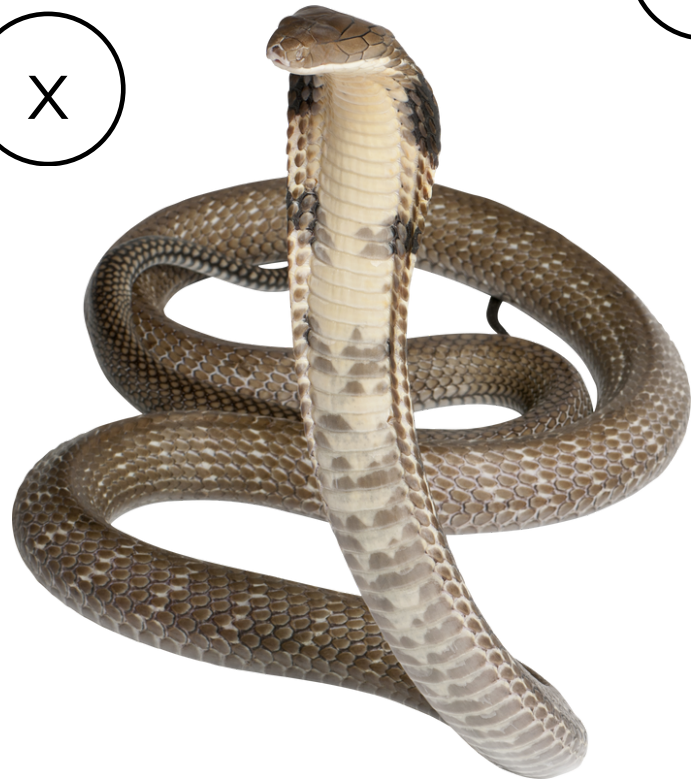
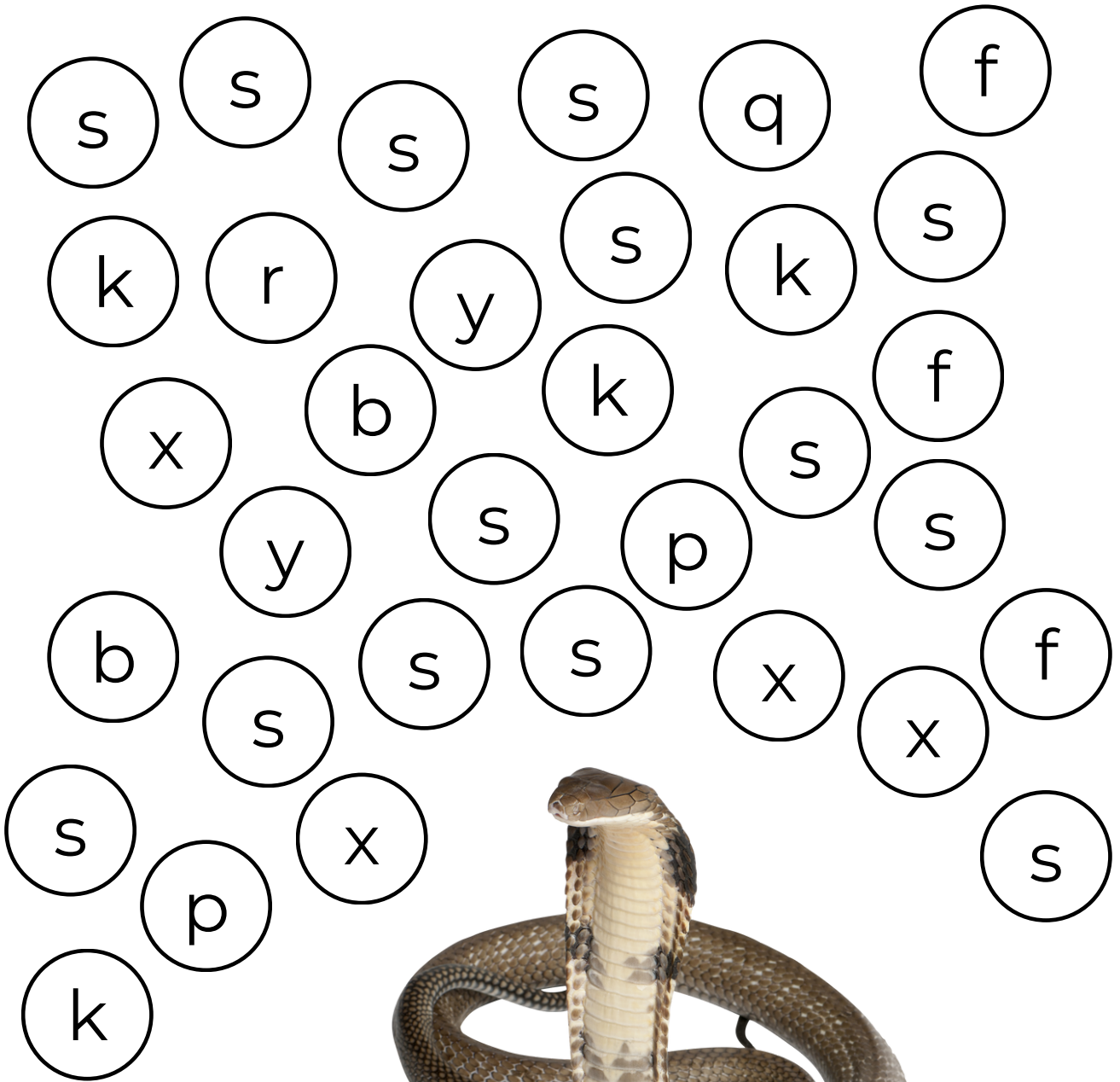

SERPENT / serpent

Nom _____

Date _____

Repasse sur la lettre T / t

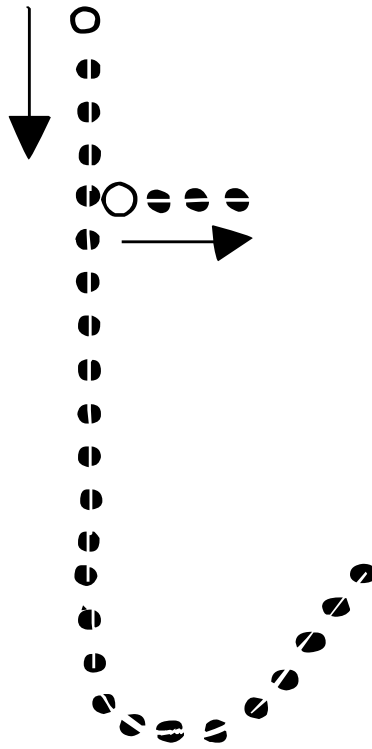

Nom _____

Date _____

Repasse sur la lettre T / t

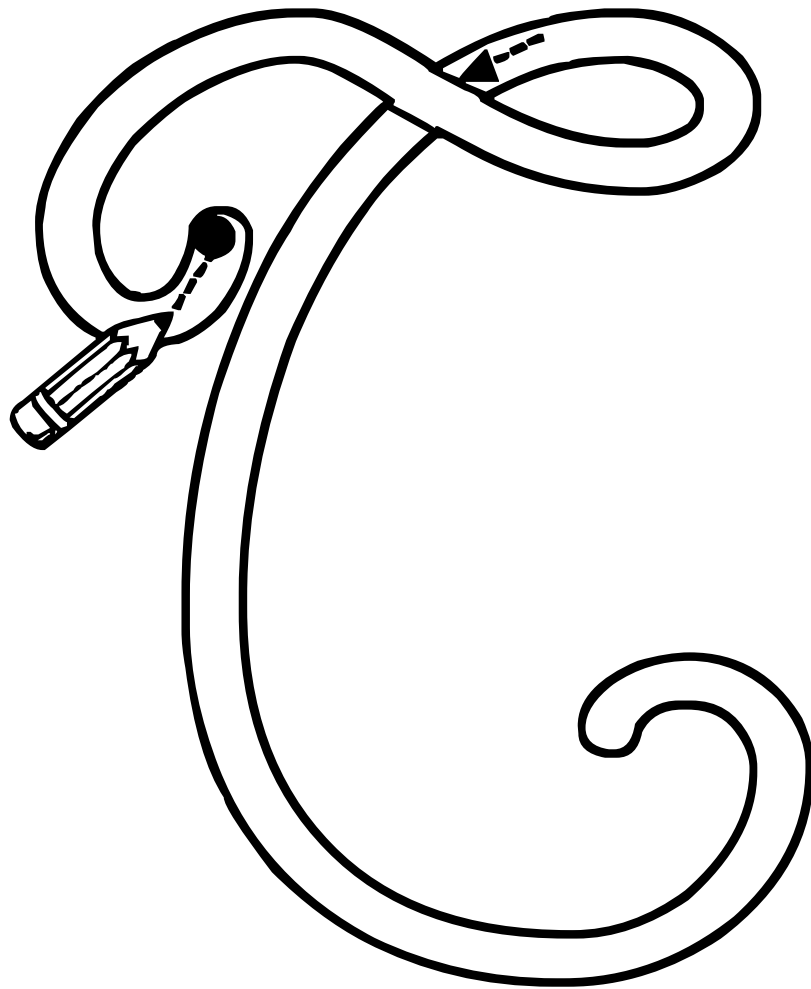

Nom _____

Date _____

Repasse sur la lettre T / t

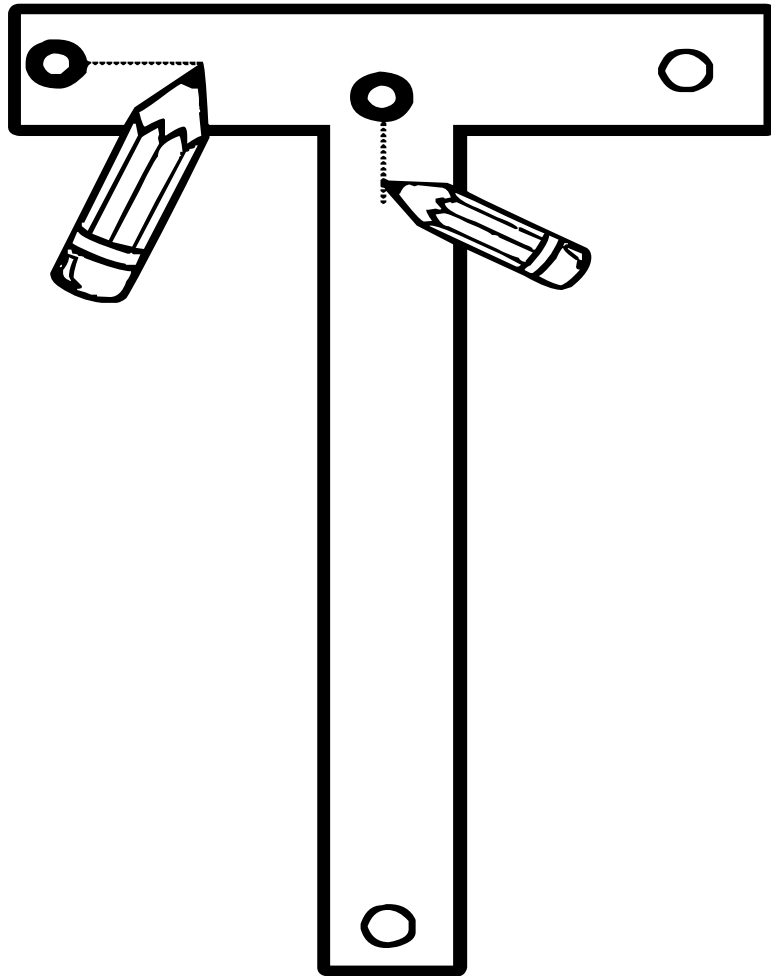

Nom _____

Date _____

Ecris la lettre T / t

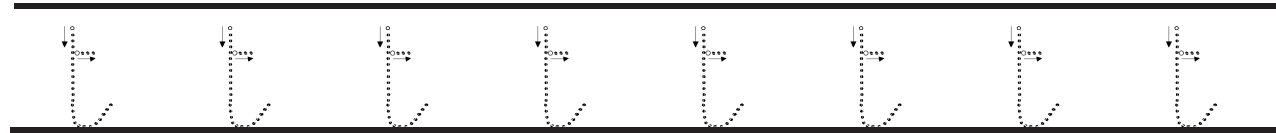
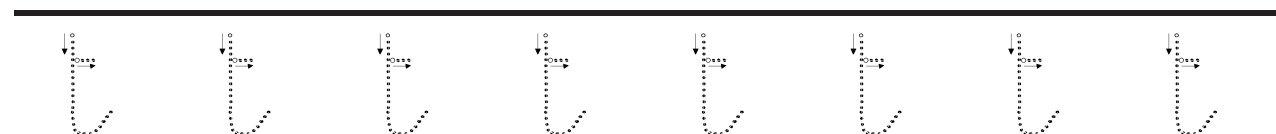
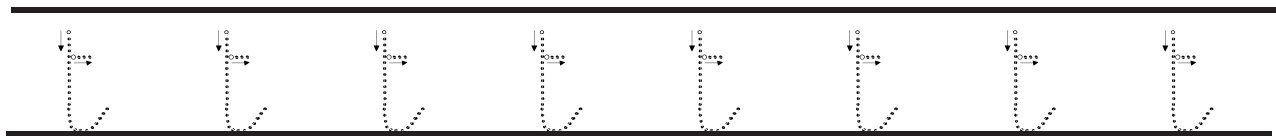
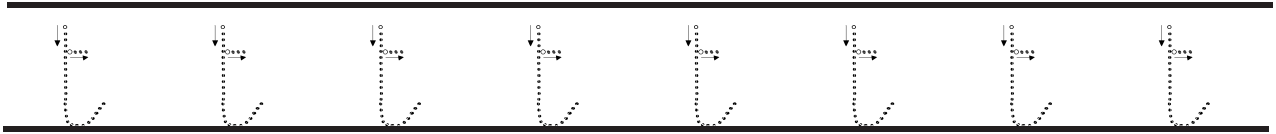
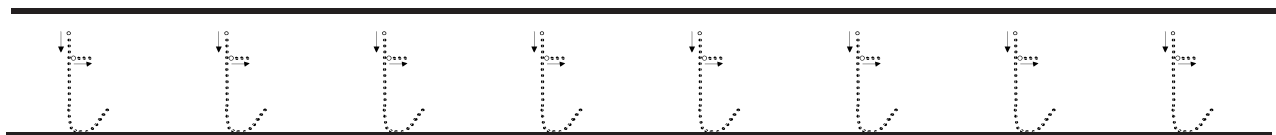
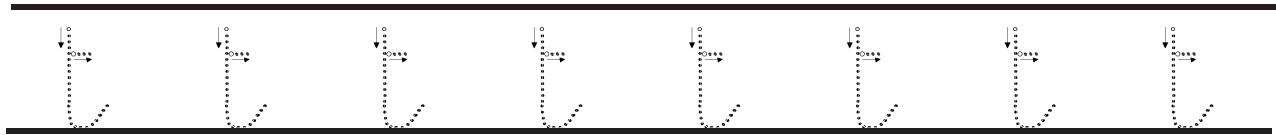
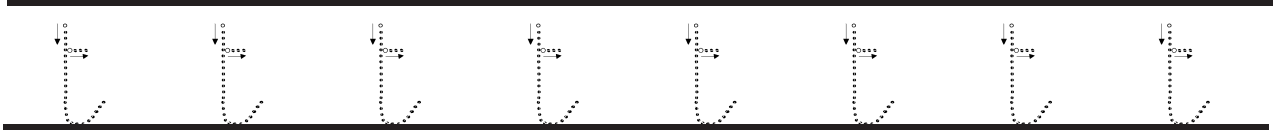

Nom _____

Date _____

Ecris la lettre T / t

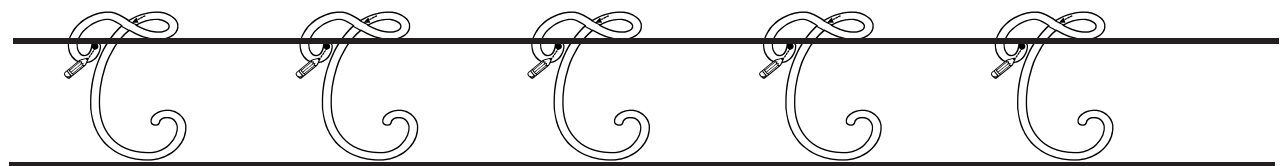
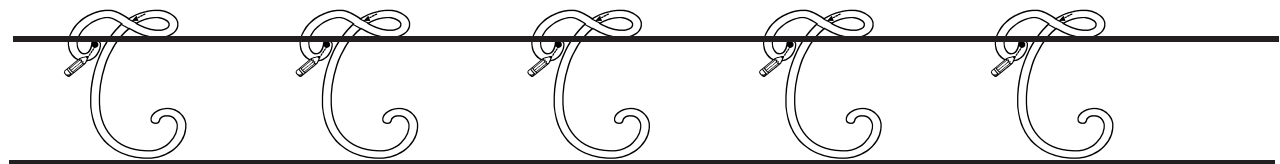
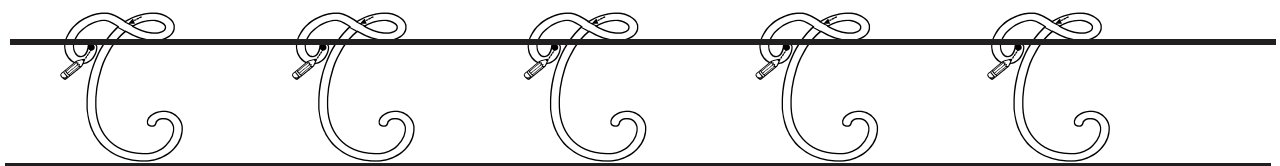
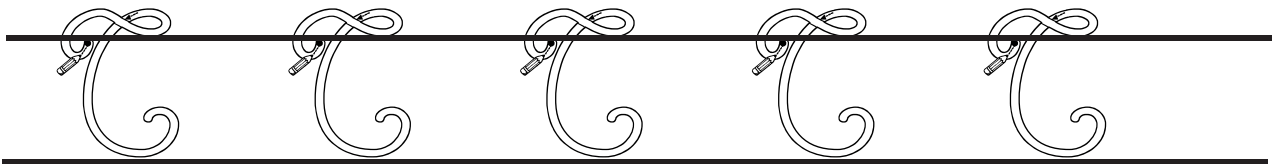
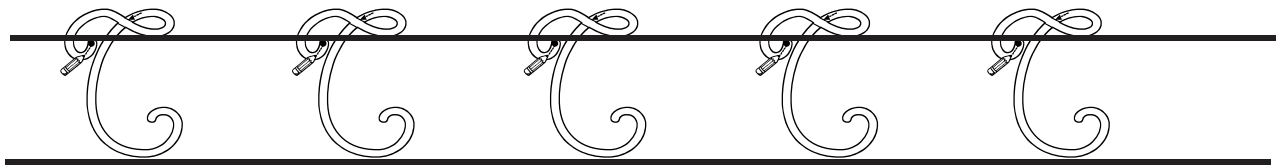
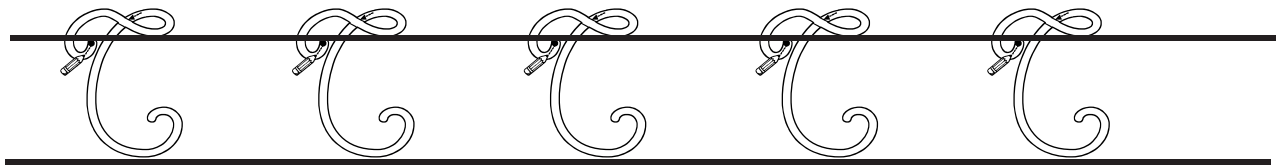
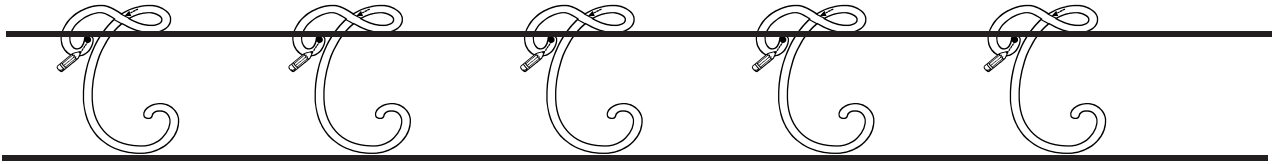

Nom _____ Date _____

Ecris la lettre T/t

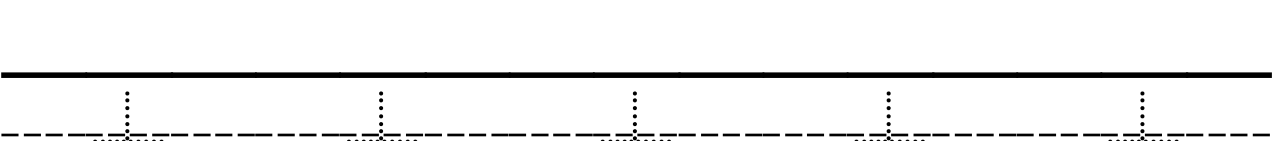
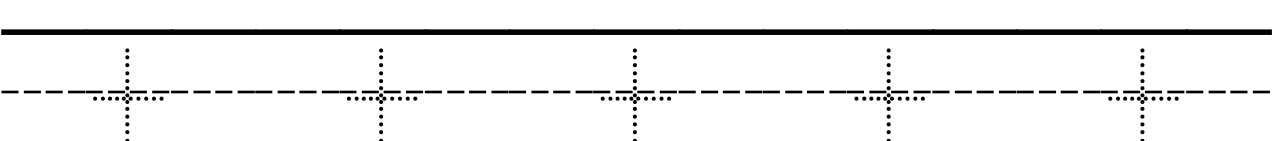
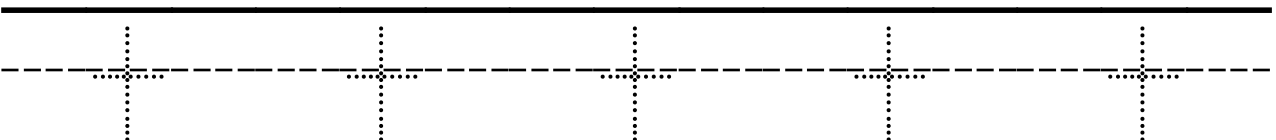
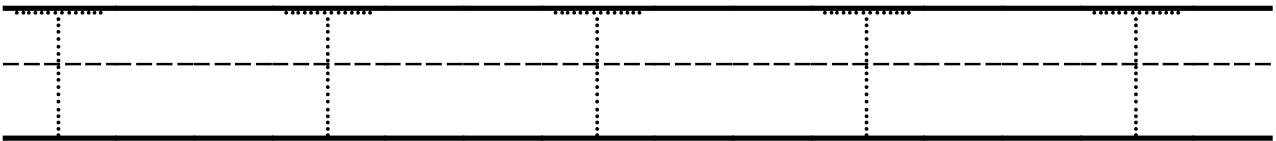
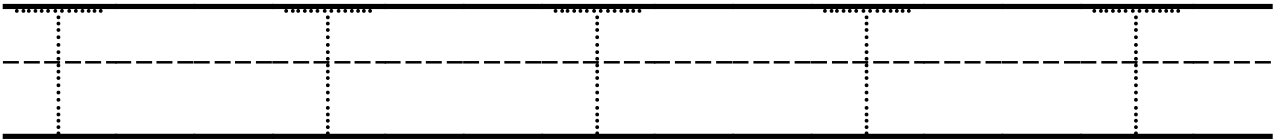
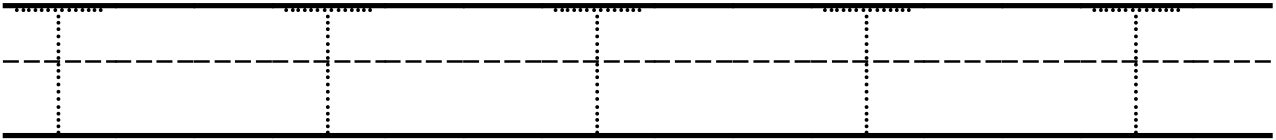
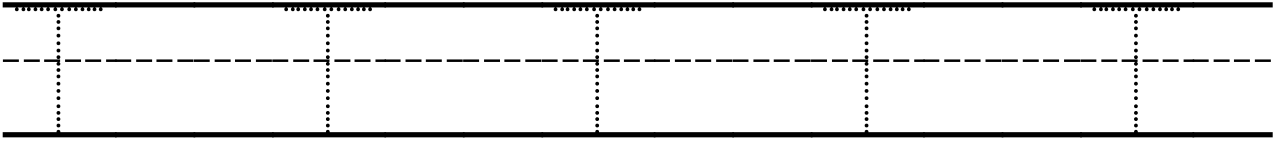

Nom _____ Date _____

Ecris la lettre T/t

T T T T T

Handwriting practice lines for uppercase 'T'. The first set of lines is a solid top line, a dashed middle line, and a solid bottom line. The second set of lines is a solid top line, a dashed middle line, and a solid bottom line.

t t t t t

Handwriting practice lines for lowercase 't'. The first set of lines is a solid top line, a dashed middle line, and a solid bottom line. The second set of lines is a solid top line, a dashed middle line, and a solid bottom line.

Nom _____

Date _____

Colorie la lettre T

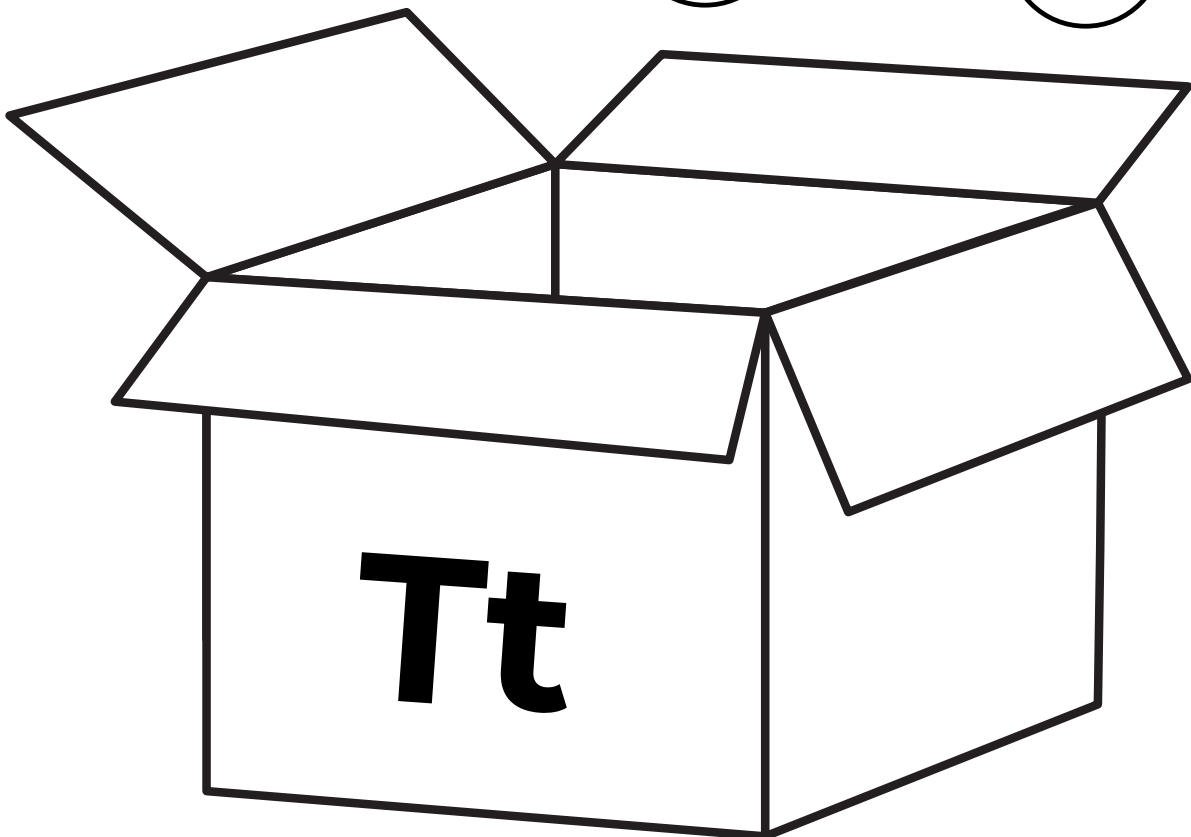
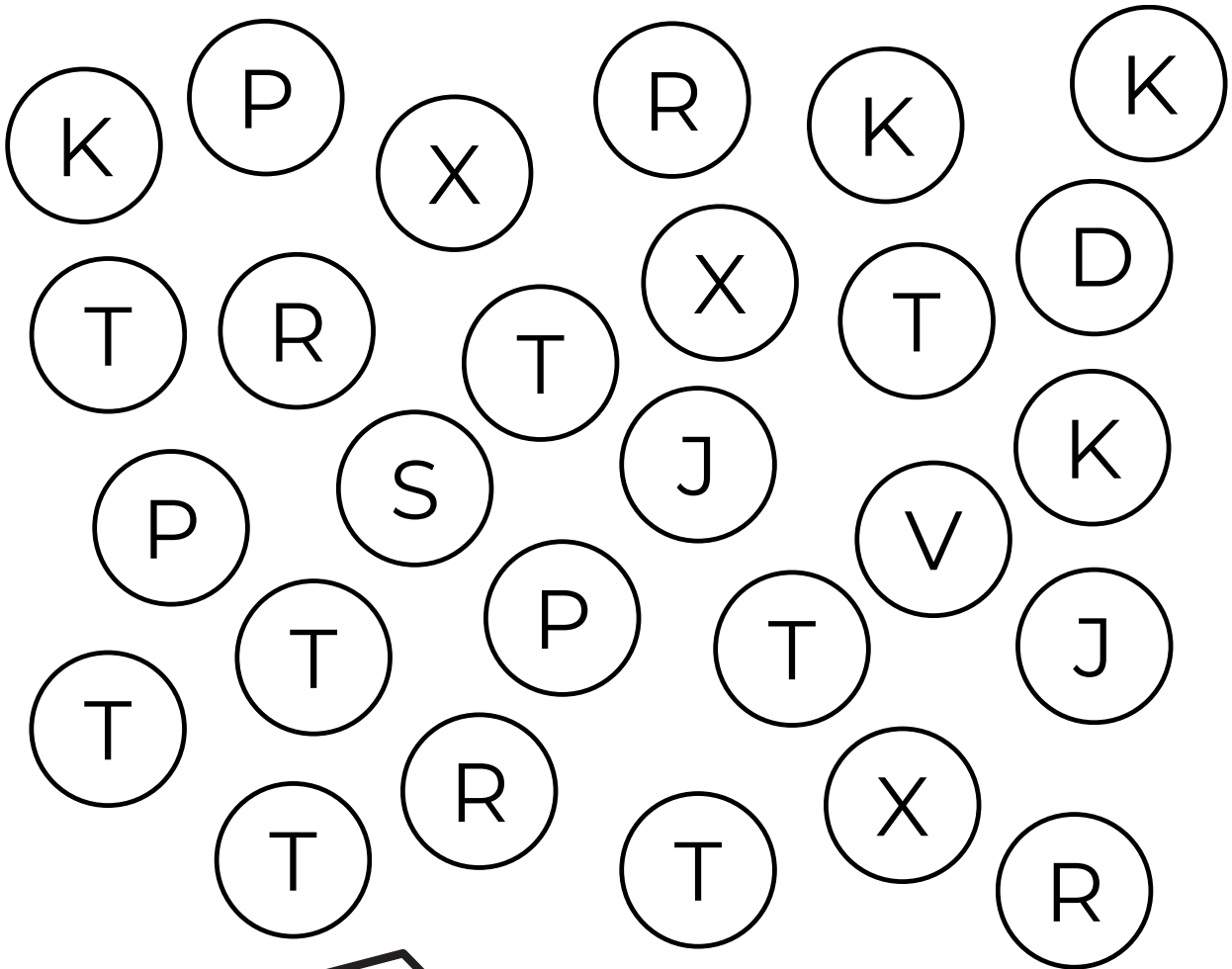

Nom _____

Date _____

Colorie la lettre t

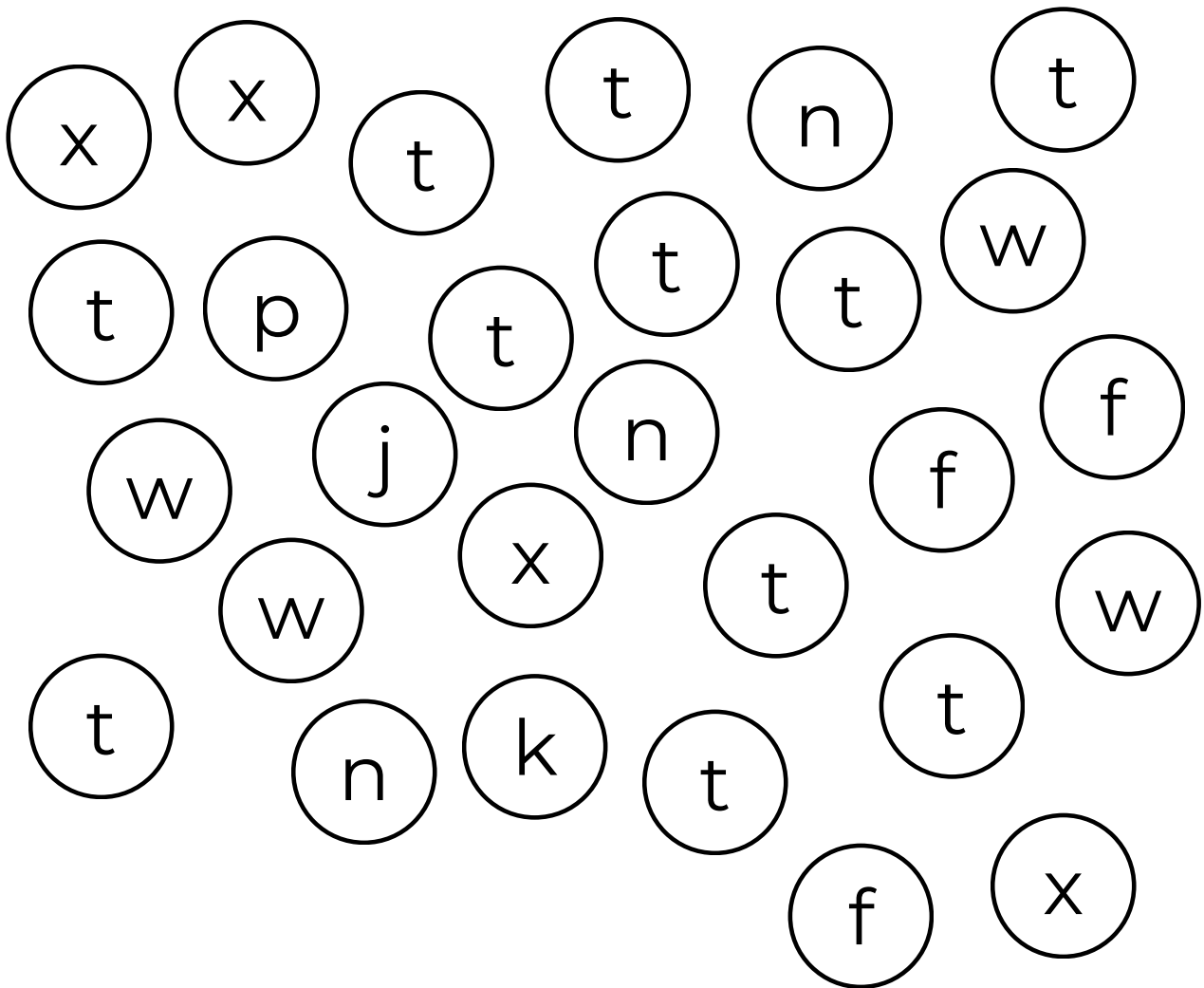

TENTE / tente



Nom _____

Date _____

Repasse sur la lettre U / u

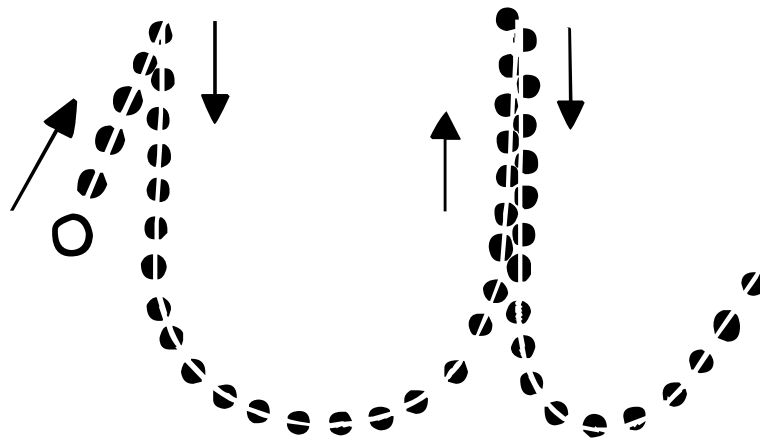

Nom _____

Date _____

Repasse sur la lettre U / u

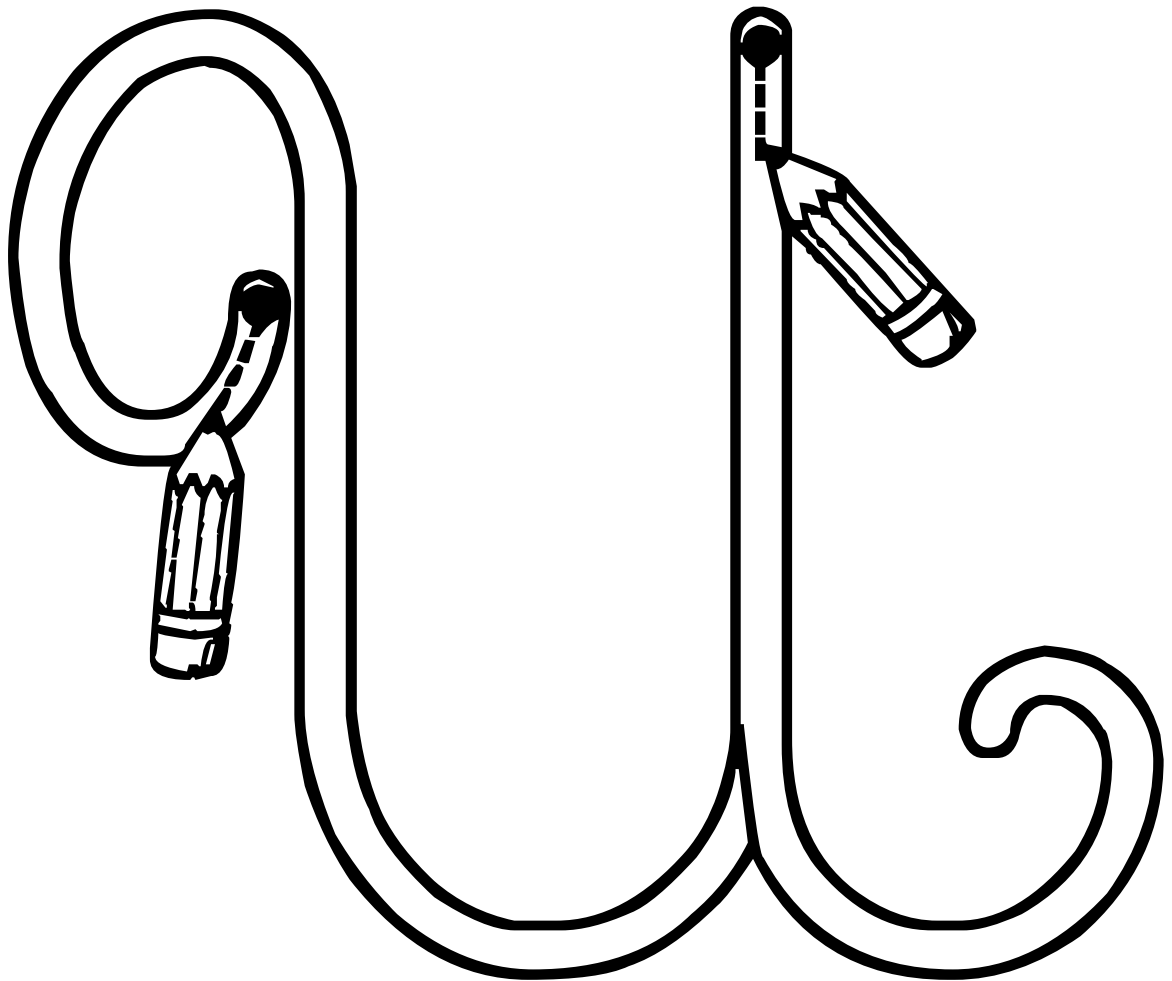

Nom _____

Date _____

Repasse sur la lettre U / u

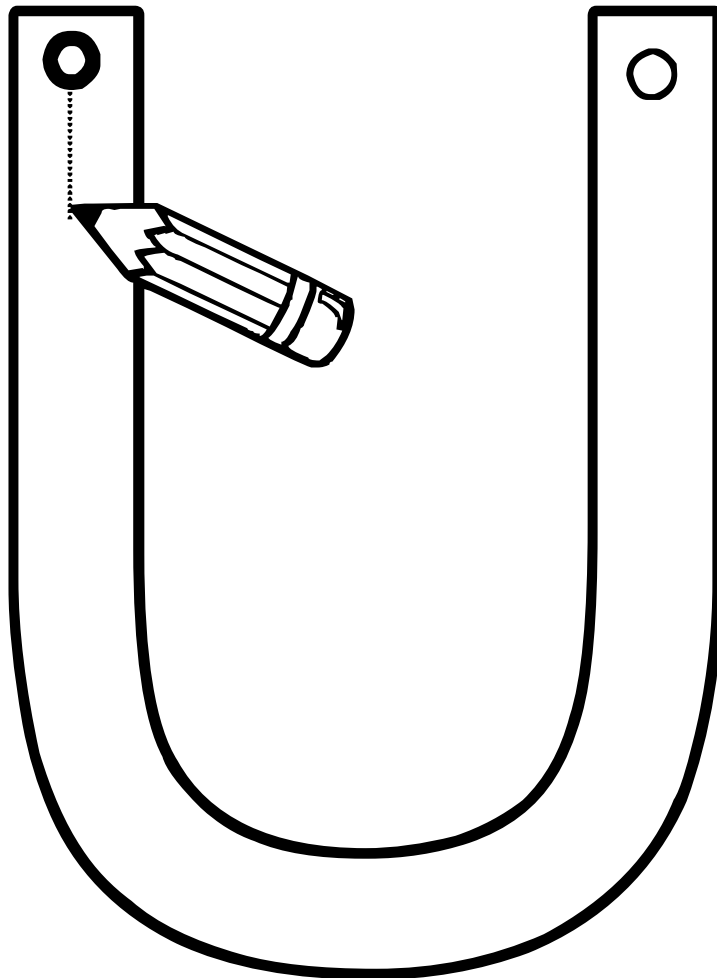

Nom _____

Date _____

Ecris la lettre U / u

U U U U U U

U U U U U U

U U U U U U

U U U U U U

U U U U U U

U U U U U U

U U U U U U

Nom _____

Date _____

Ecris la lettre U / u

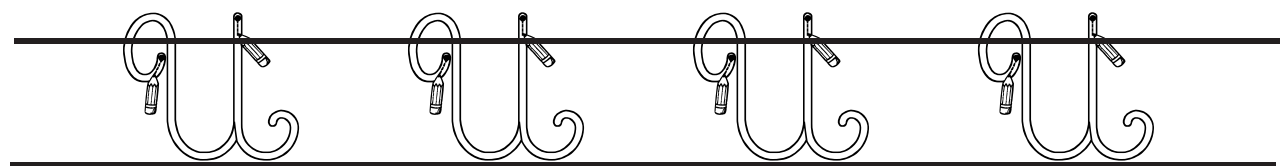
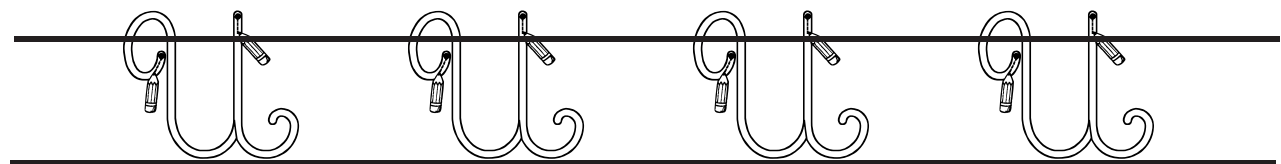
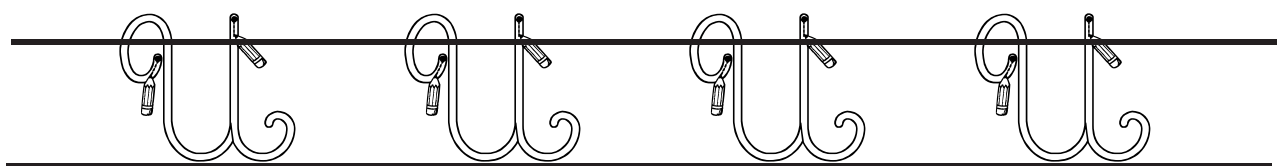
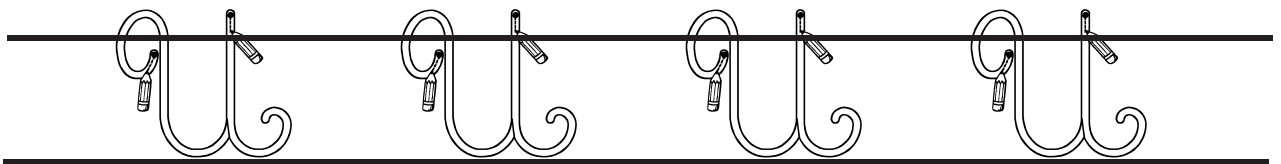
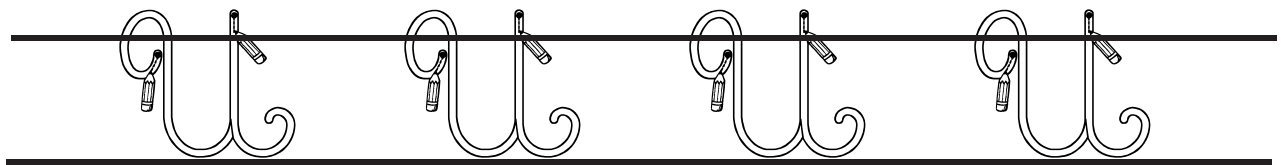
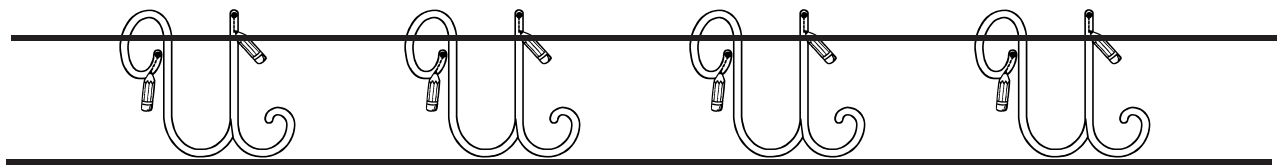
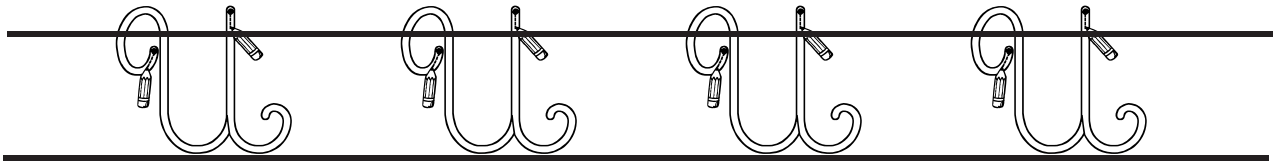

Nom _____ Date _____

Ecris la lettre U/u

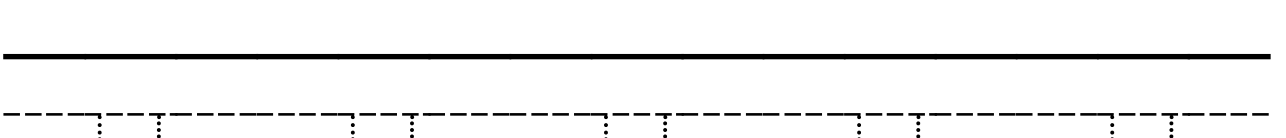
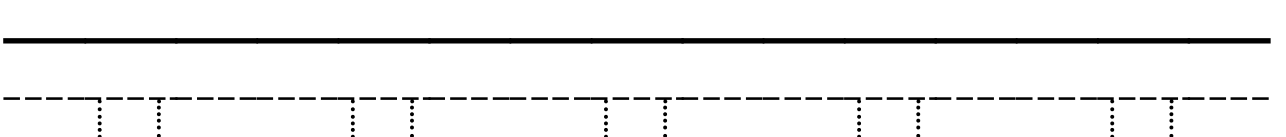
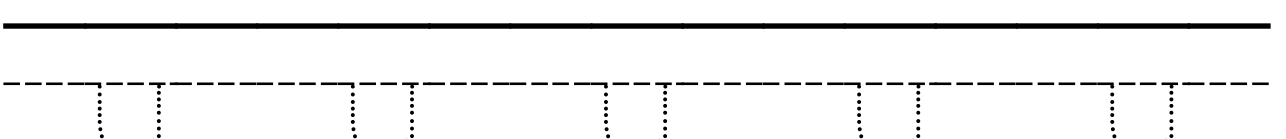
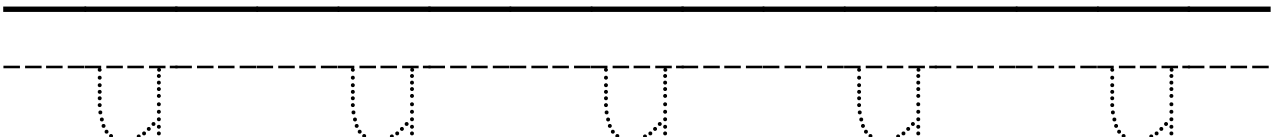
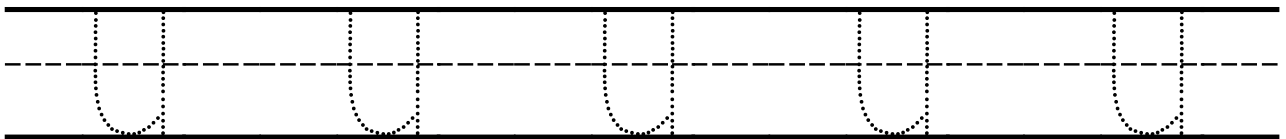
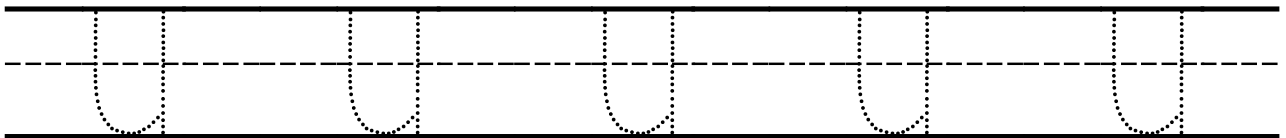
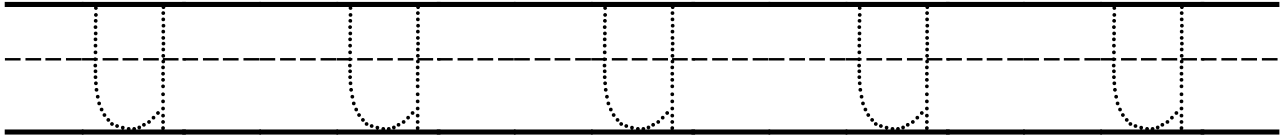
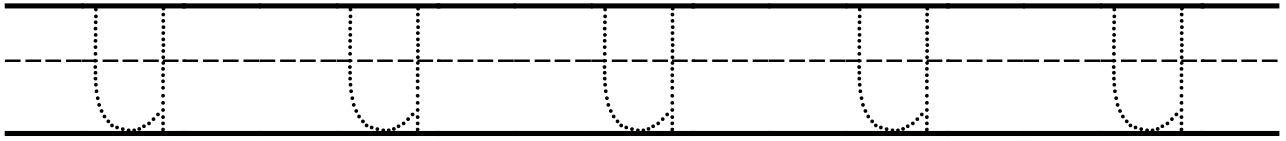

Nom _____ Date _____

Ecris la lettre U/u

U U U U U

Handwriting practice lines for uppercase 'U'. Each row consists of a solid top line, a dashed middle line, and a solid bottom line. There are two such rows provided for practice.

u u u u u

Handwriting practice lines for lowercase 'u'. Each row consists of a solid top line, a dashed middle line, and a solid bottom line. There are two such rows provided for practice.

Nom _____

Date _____

Colorie la lettre U

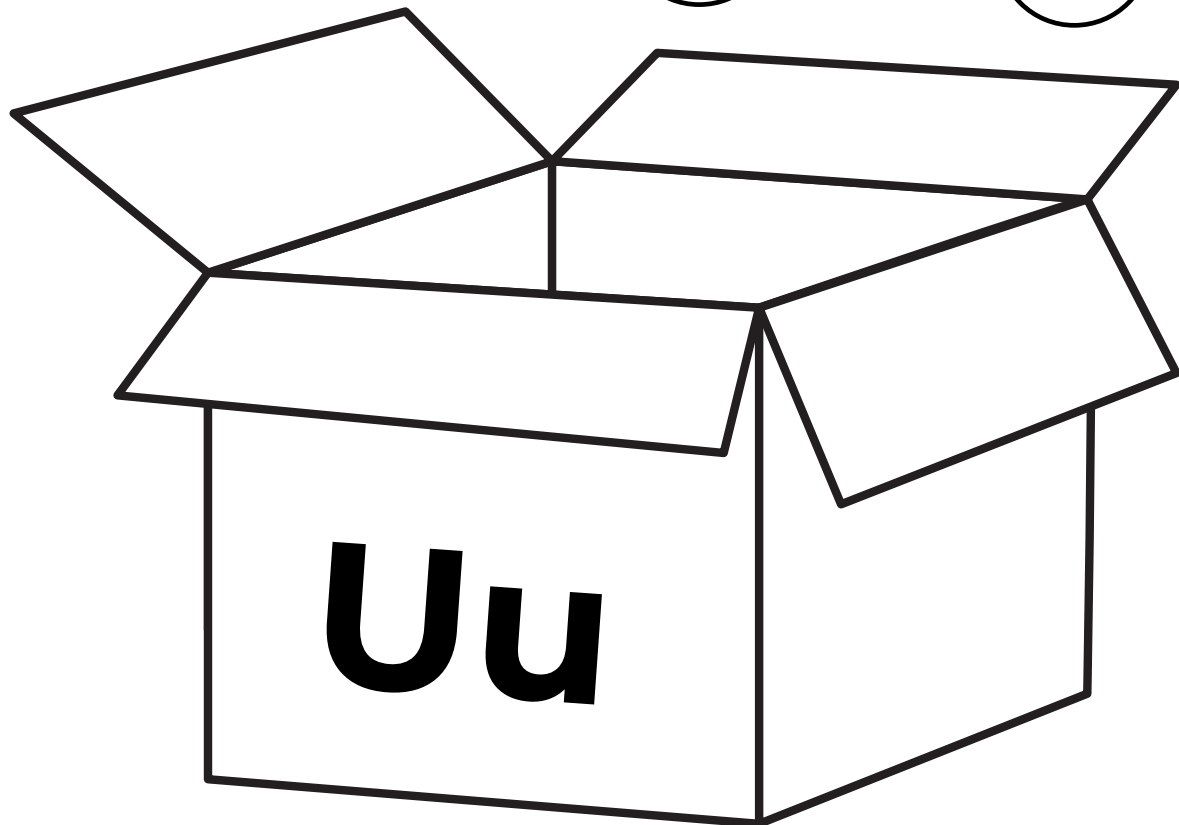
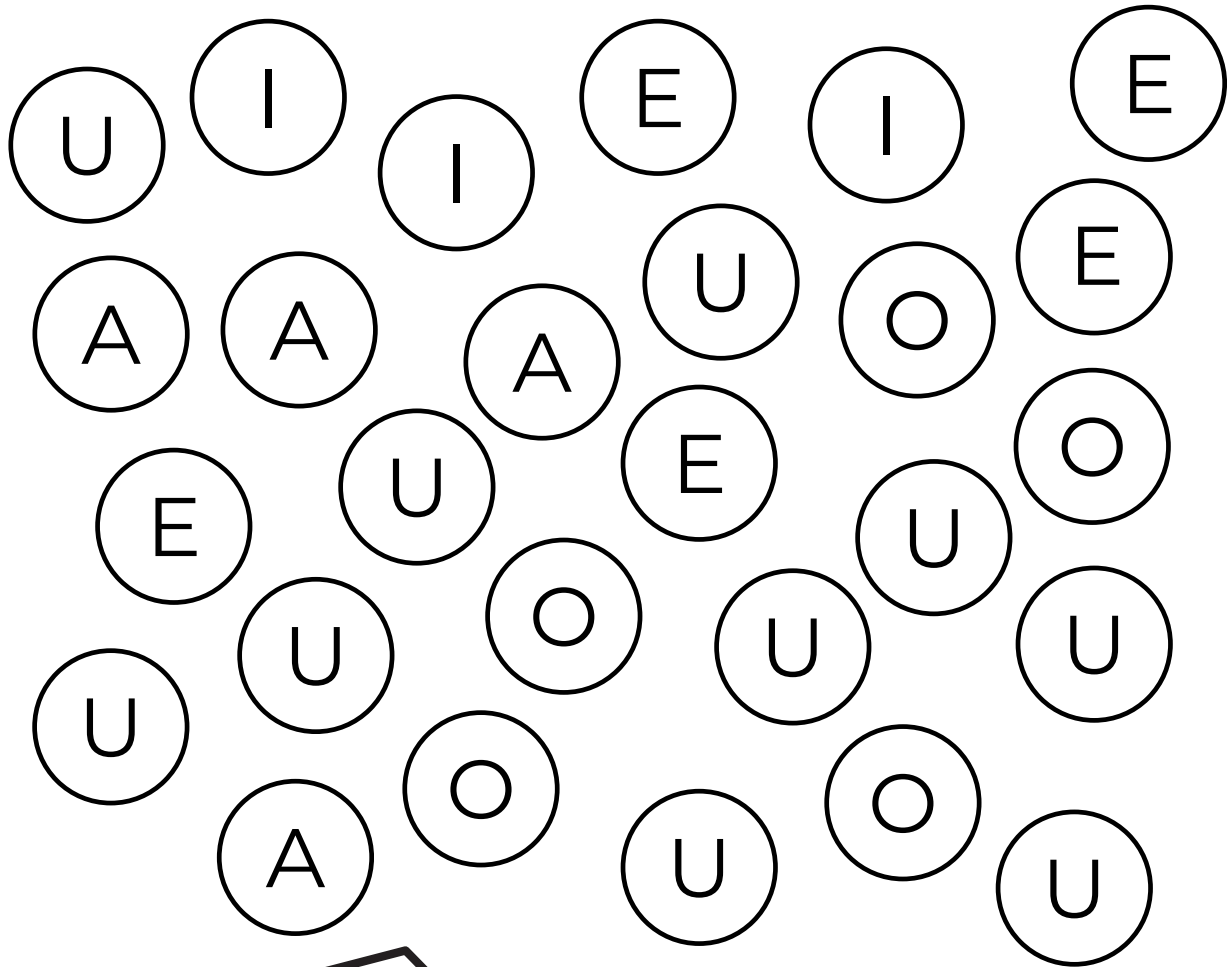

Nom _____

Date _____

Colorie la lettre u

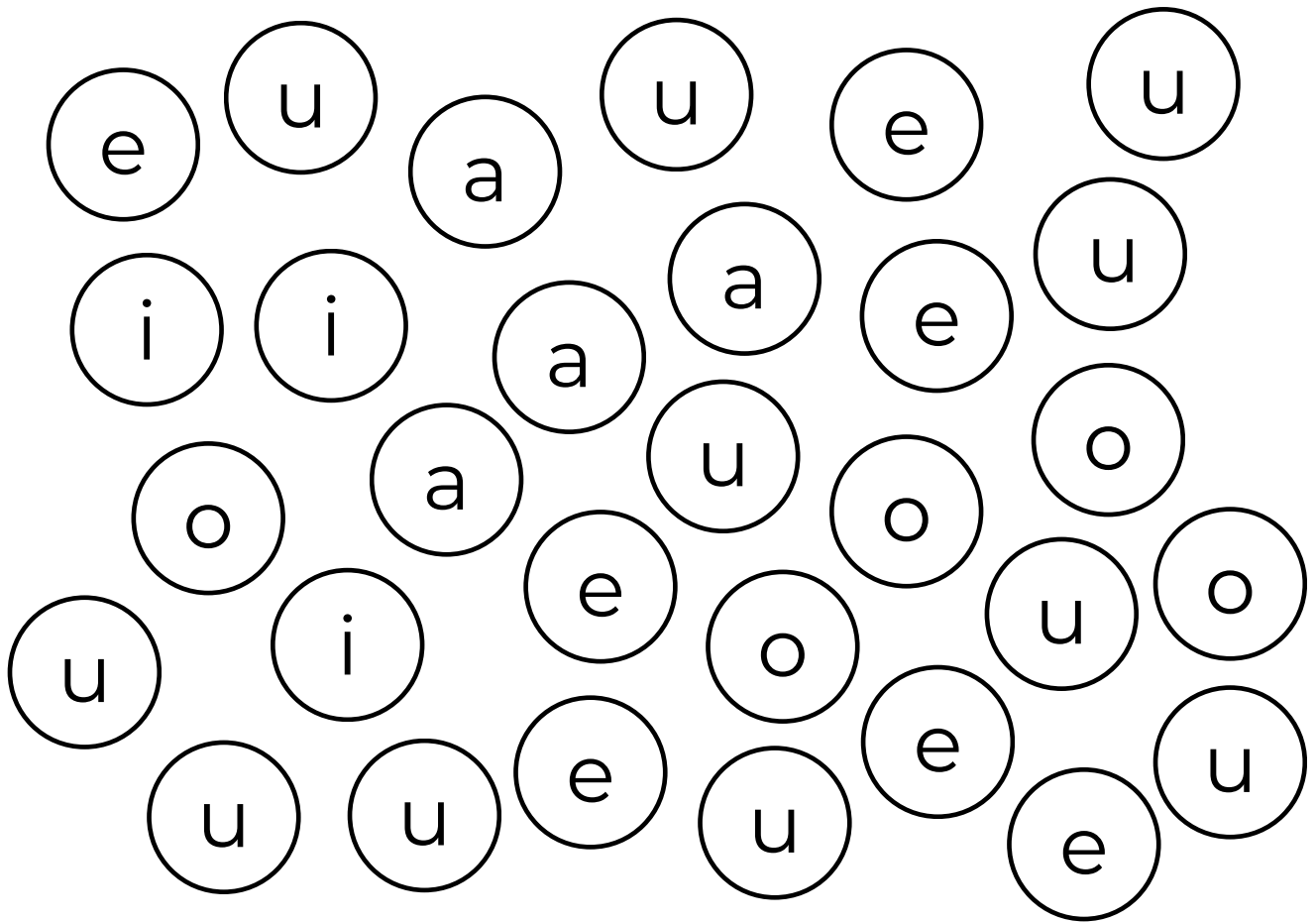

USTENSILES
ustensiles



Nom _____

Date _____

Repasse sur la lettre V / v

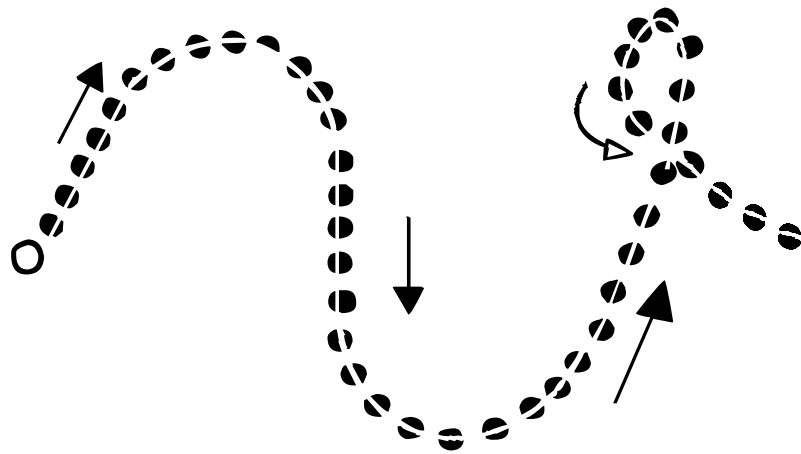

Nom _____

Date _____

Repasse sur la lettre V / v

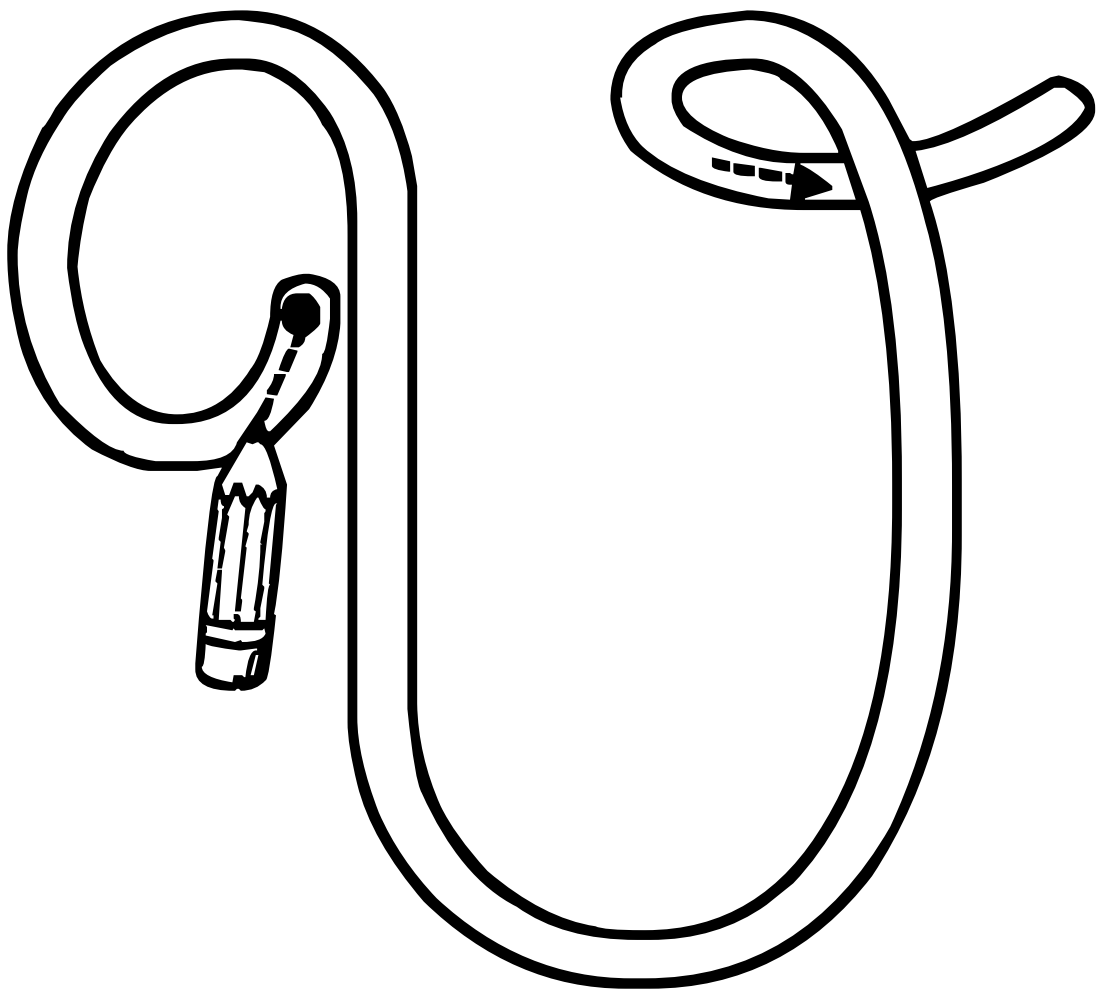

Nom _____

Date _____

Repasse sur la lettre V / v

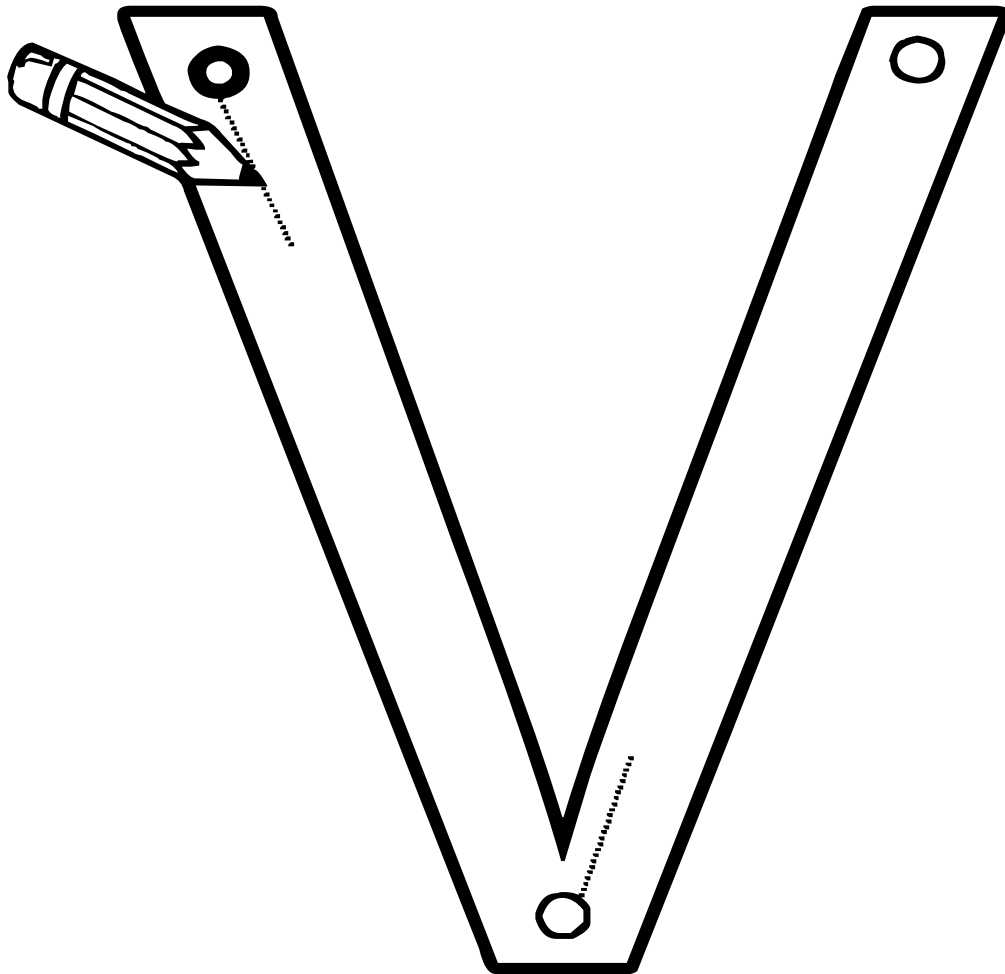

Nom _____

Date _____

Ecris la lettre V / v



Nom _____

Date _____

Ecris la lettre V / v

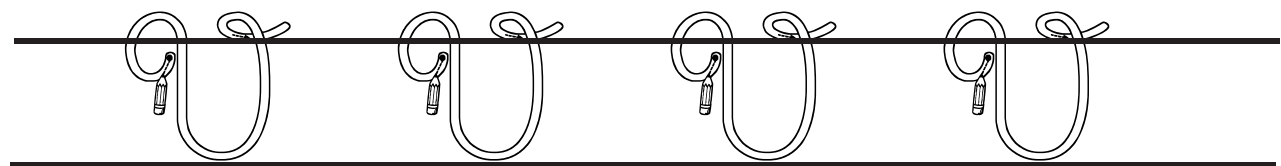
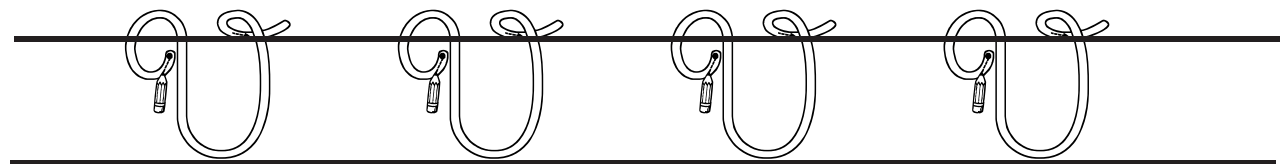
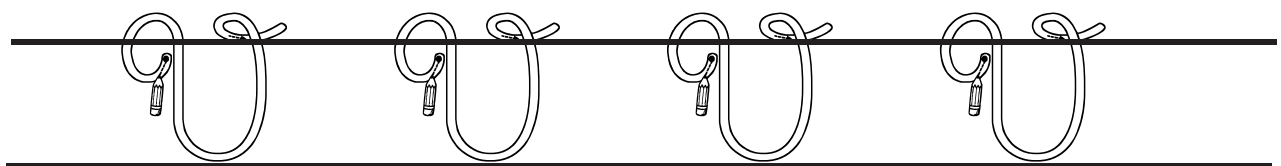
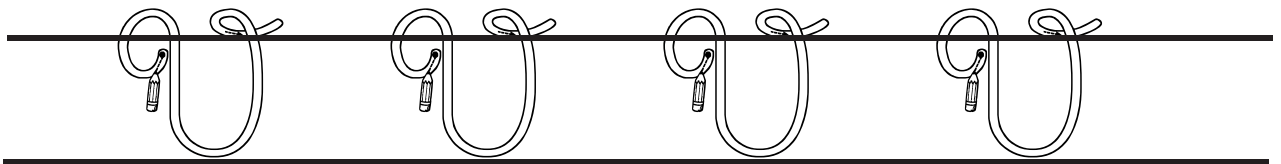
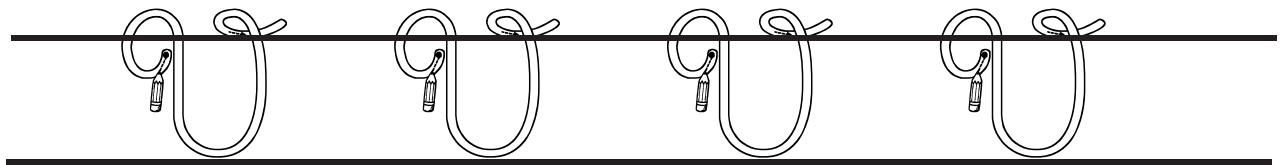
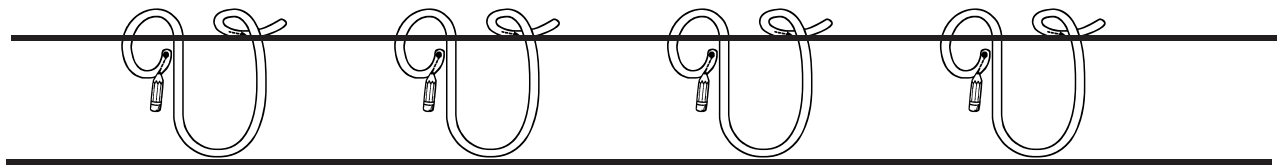
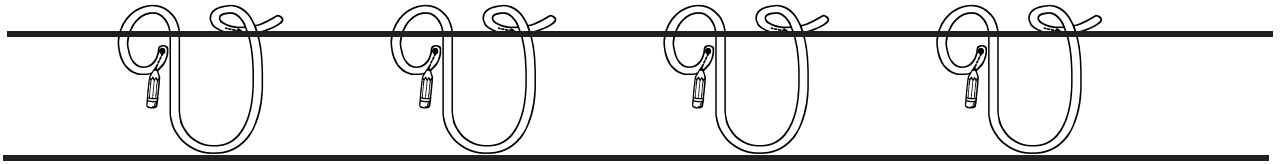

Nom _____

Date _____

Ecris la lettre V/v

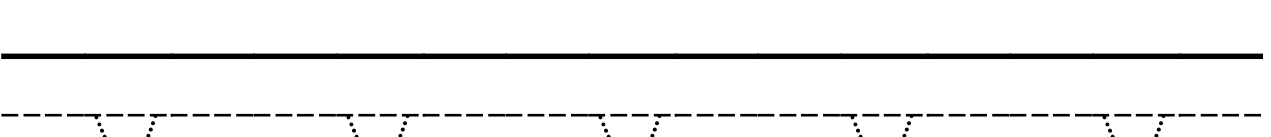
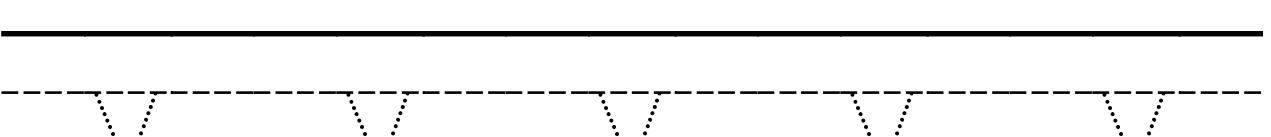
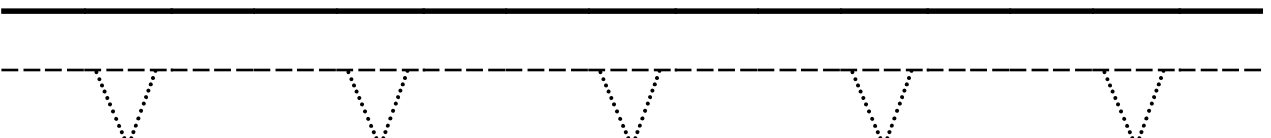
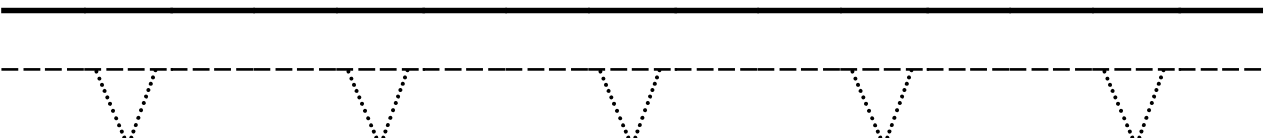
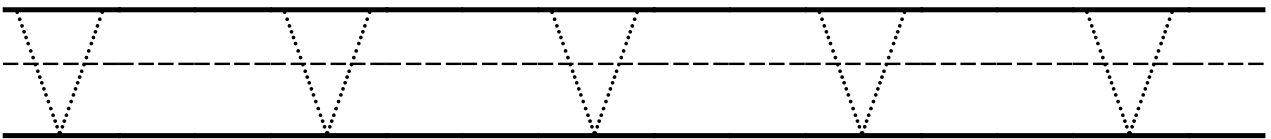
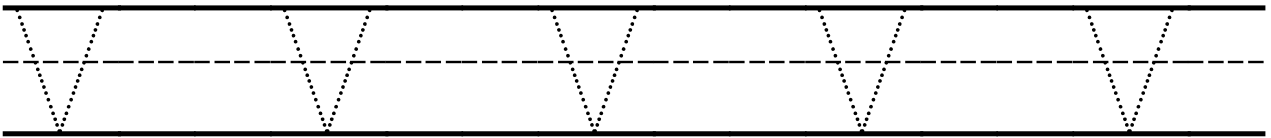
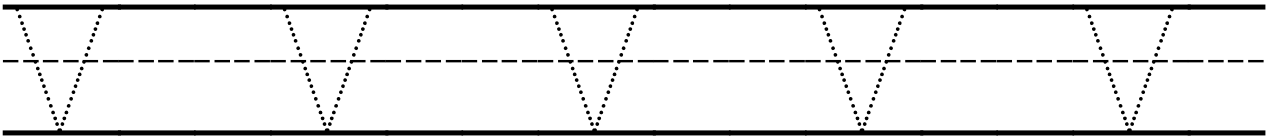
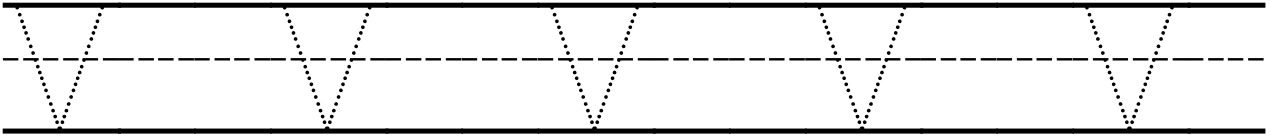

Nom _____ Date _____

Ecris la lettre V/v

V V V V V

Handwriting practice lines for uppercase letter V. Each row consists of a solid top line, a dashed middle line, and a solid bottom line. There are two such rows provided for practice.

v v v v v

Handwriting practice lines for lowercase letter v. Each row consists of a solid top line, a dashed middle line, and a solid bottom line. There are two such rows provided for practice.

Nom _____

Date _____

Colorie la lettre V

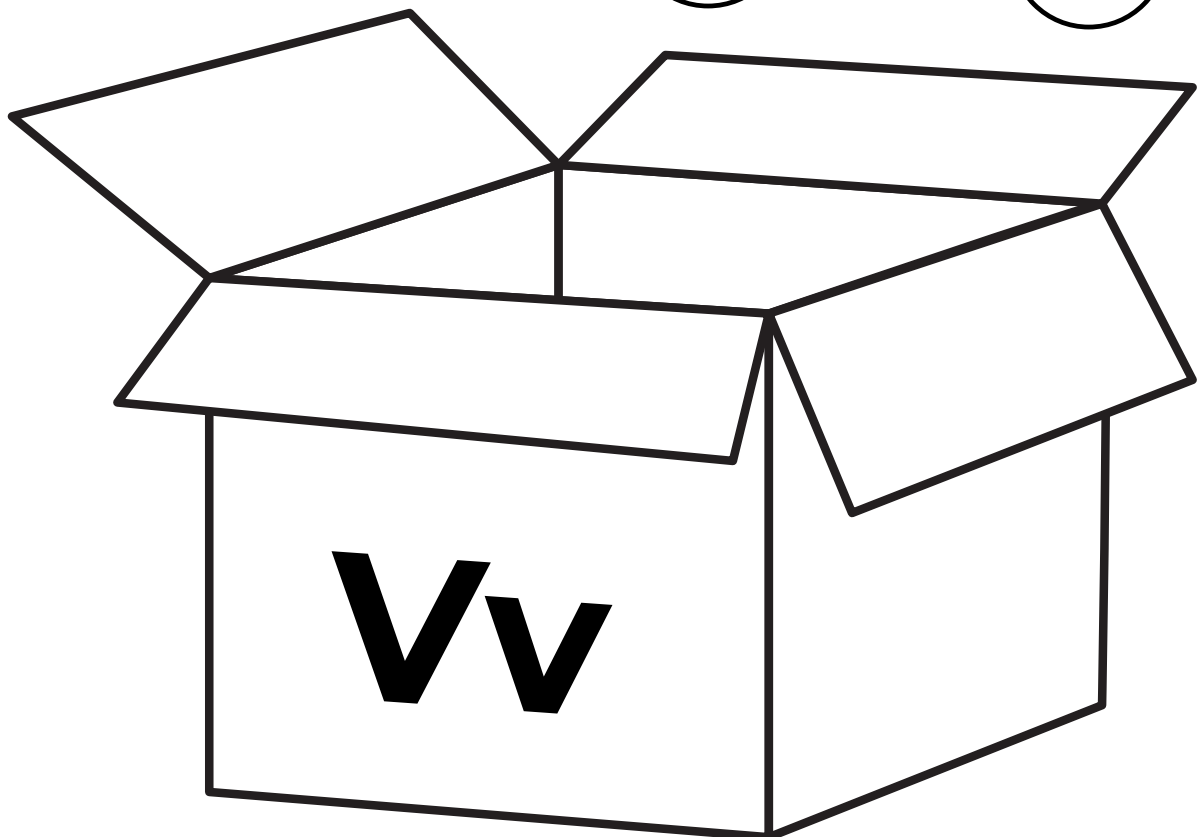
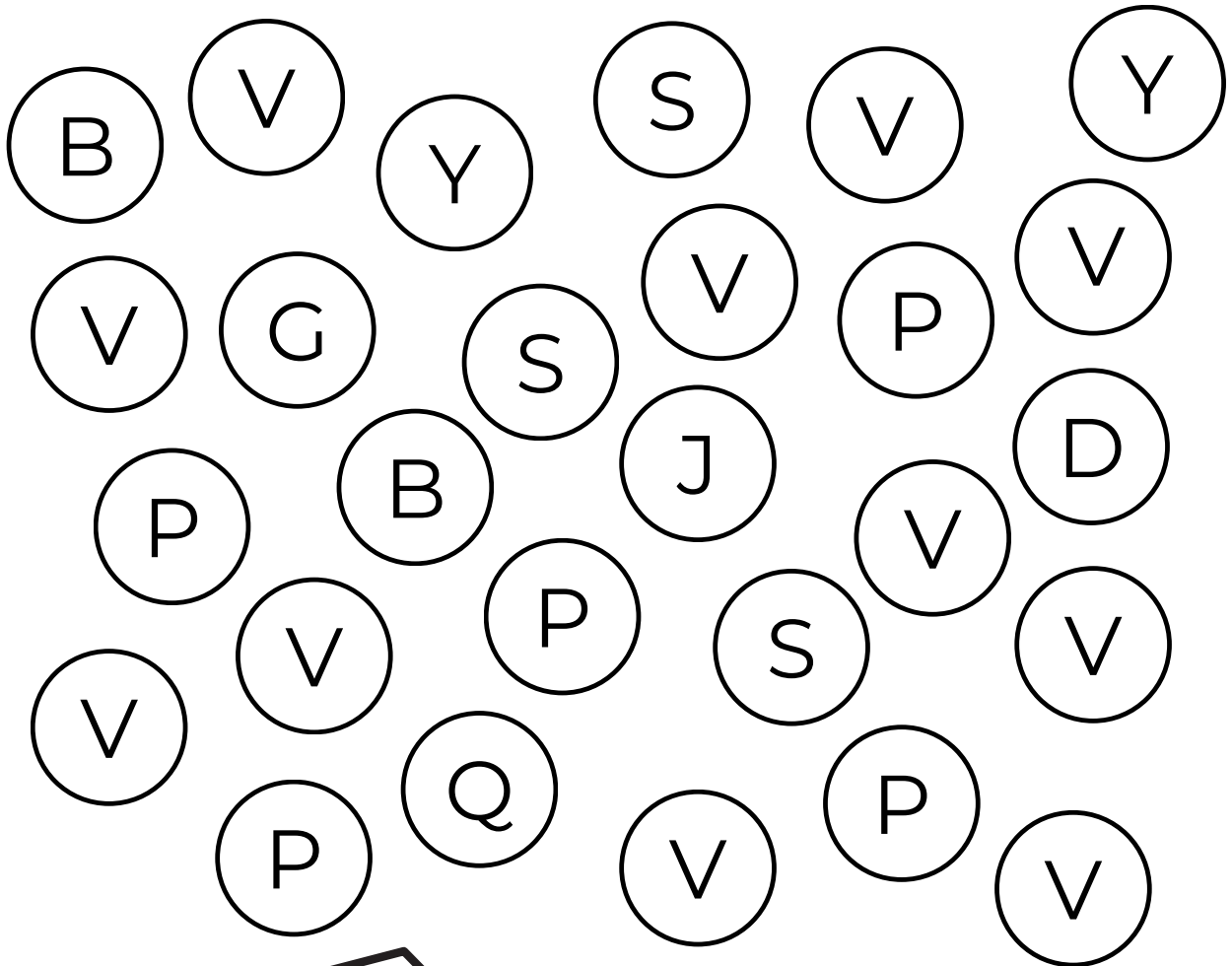

Nom _____

Date _____

Colorie la lettre v

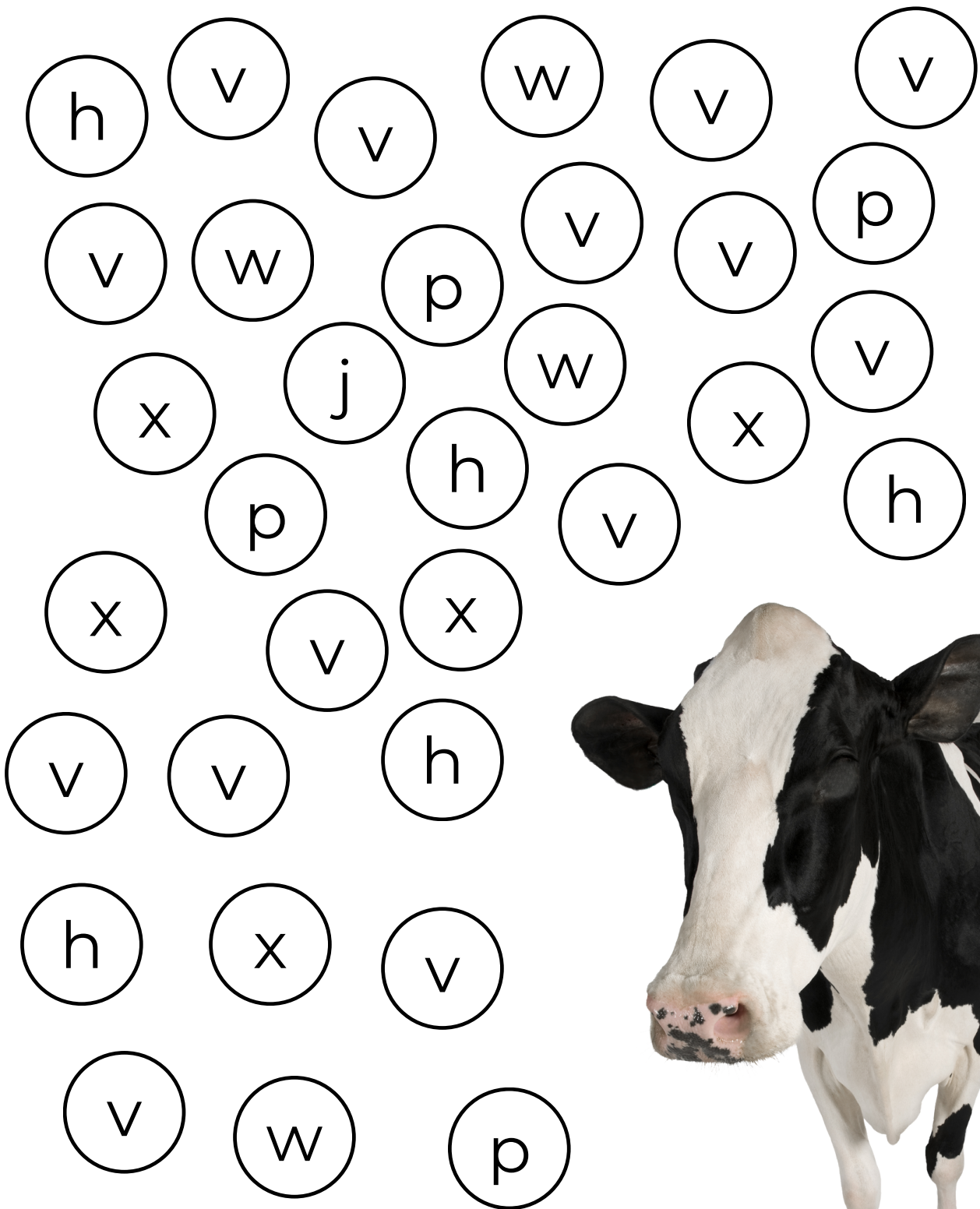

VACHE / vache

Nom _____

Date _____

Repasse sur la lettre W / w

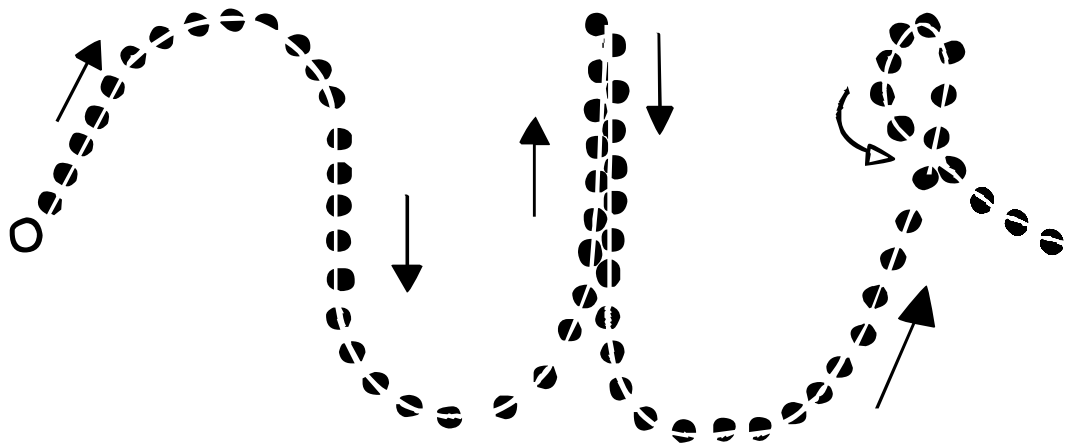

Nom _____

Date _____

Repasse sur la lettre W / w

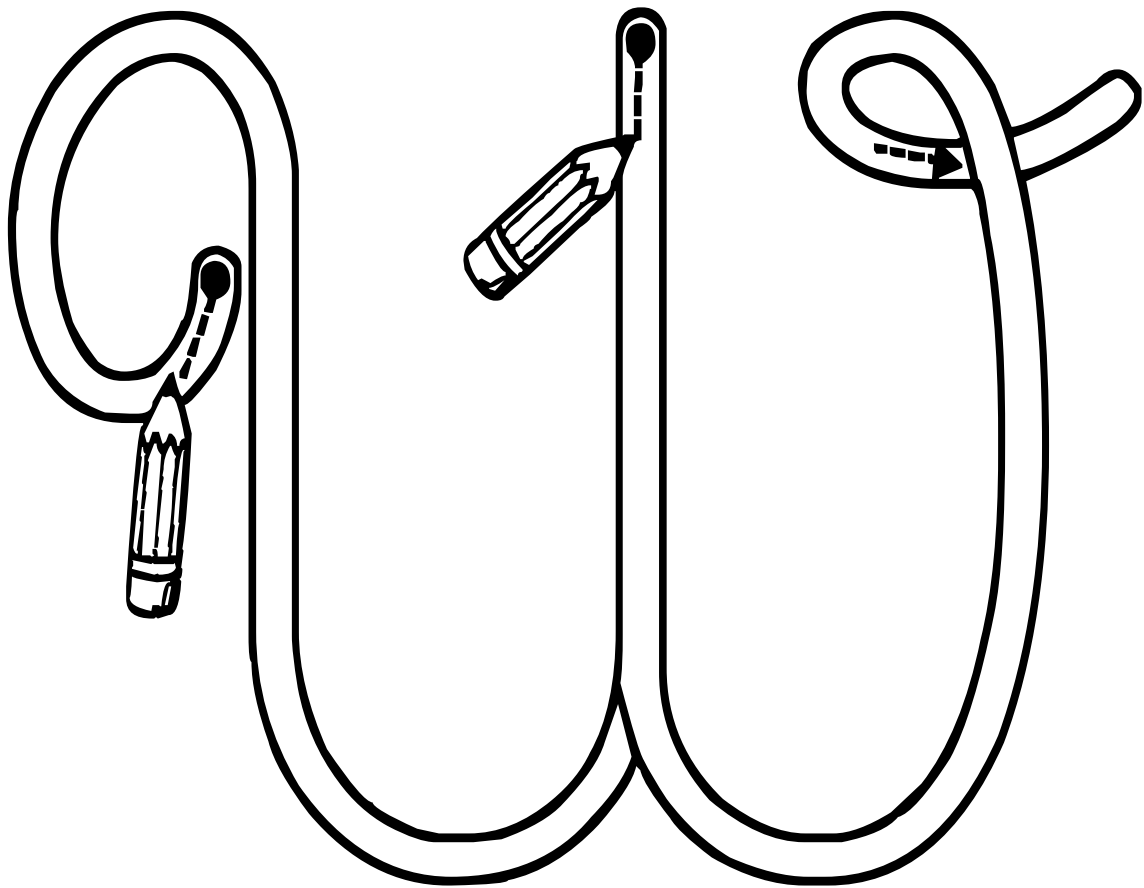

Nom _____

Date _____

Repasse sur la lettre W / w

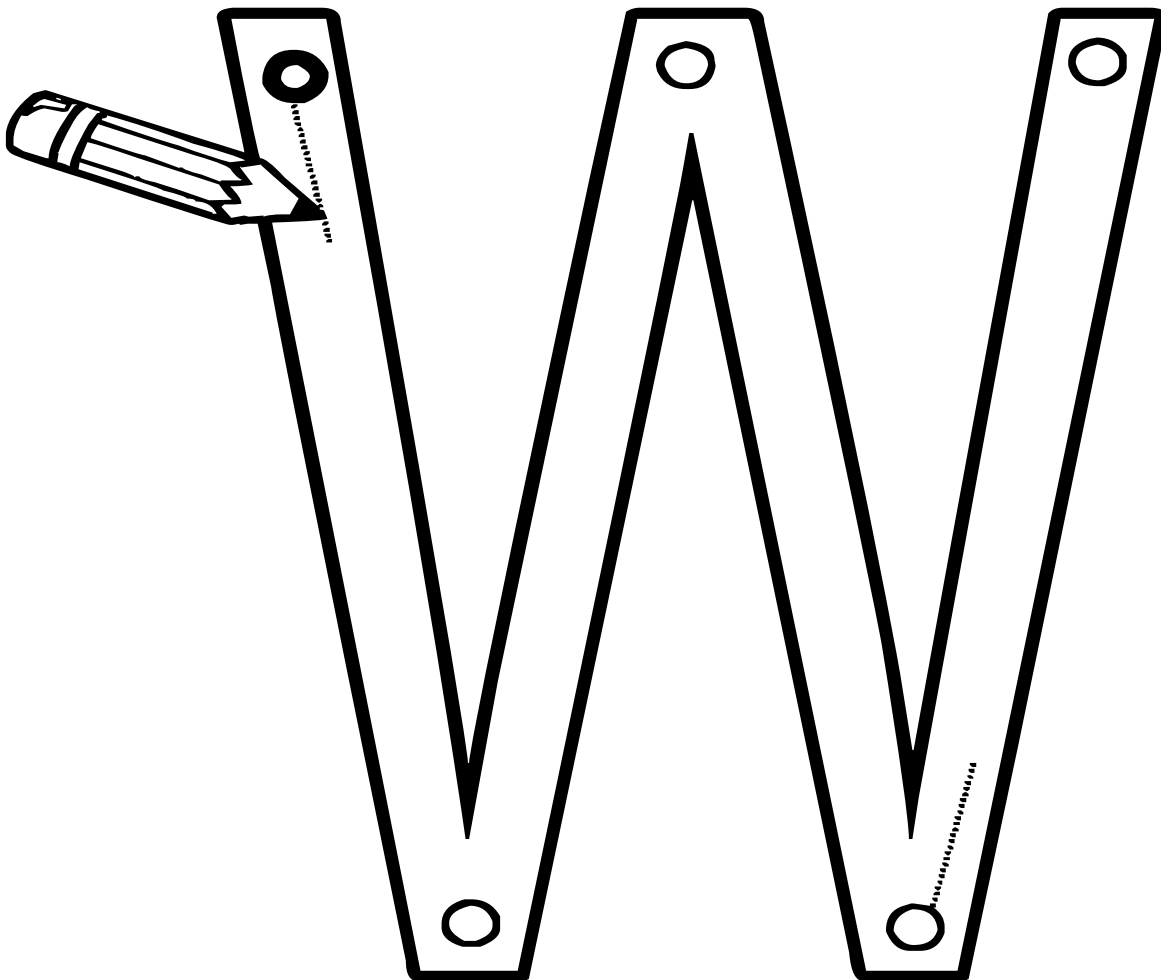

Nom _____

Date _____

Ecris la lettre W / w

W W W W W

w w w w w

W W W W W

w w w w w

W W W W W

w w w w w

W W W W W

Nom _____

Date _____

Ecris la lettre W / w

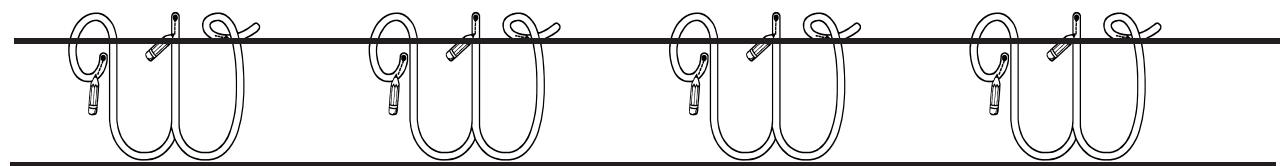
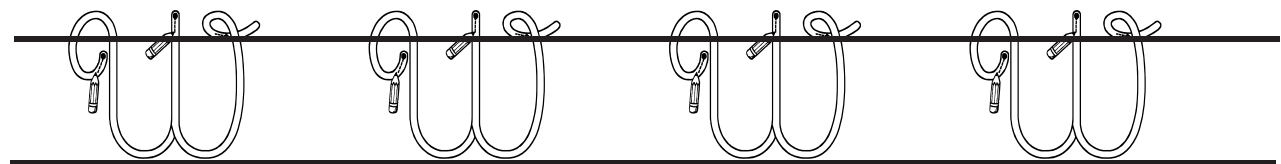
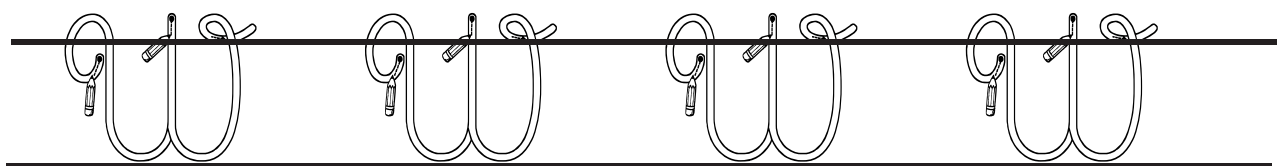
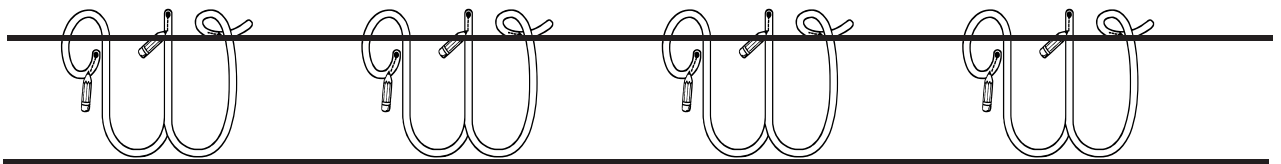
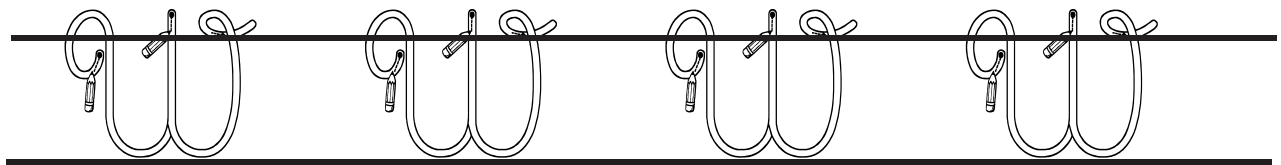
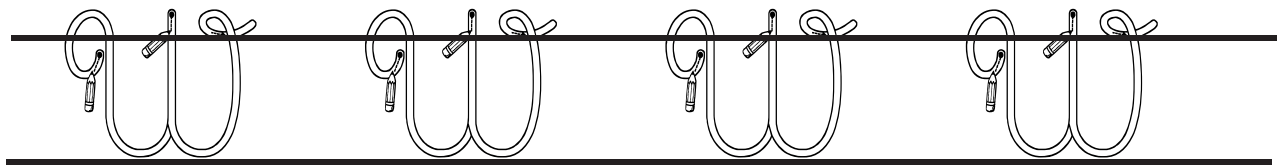
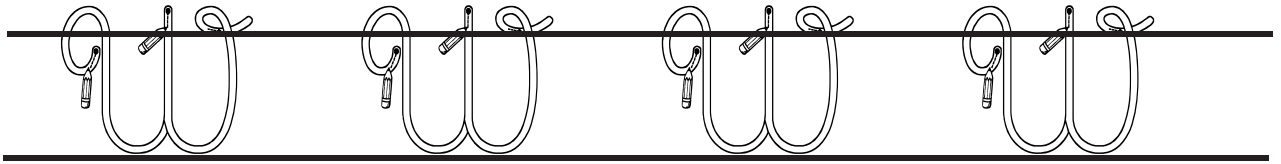

Nom _____ Date _____

Ecris la lettre W/w

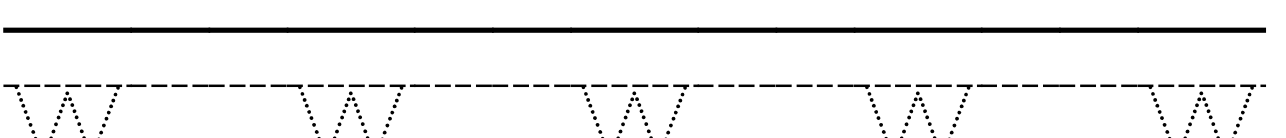
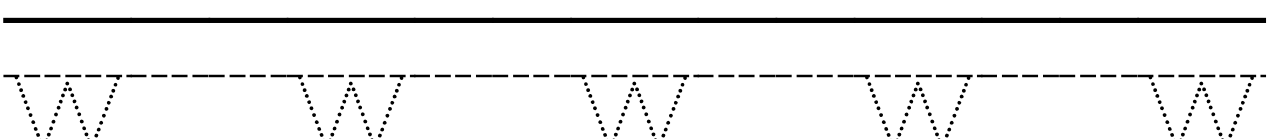
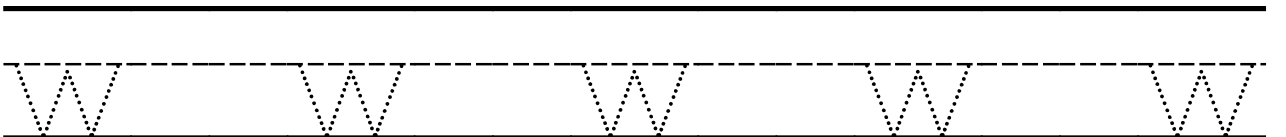
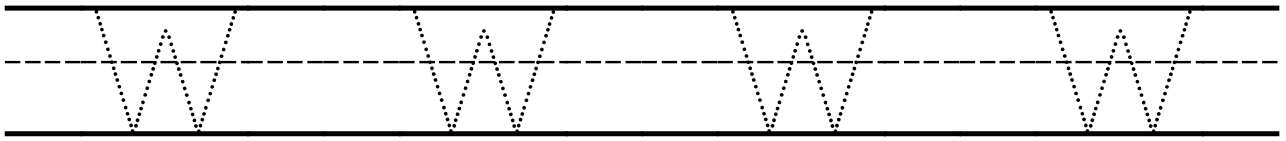

Nom _____ Date _____

Ecris la lettre W/w

W W W W W

Handwriting practice lines for uppercase 'W'. Each row consists of a solid top line, a dashed middle line, and a solid bottom line.

w w w w w

Handwriting practice lines for lowercase 'w'. Each row consists of a solid top line, a dashed middle line, and a solid bottom line.

Nom _____

Date _____

Colorie la lettre W

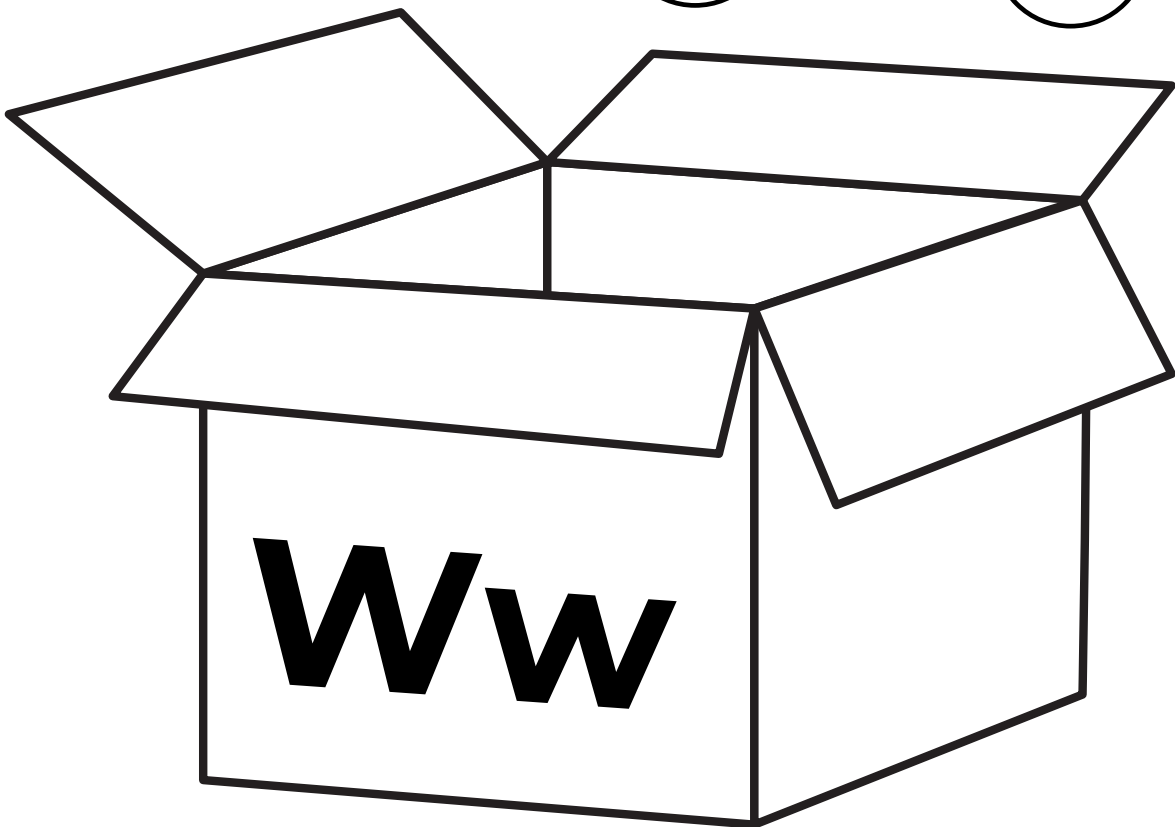
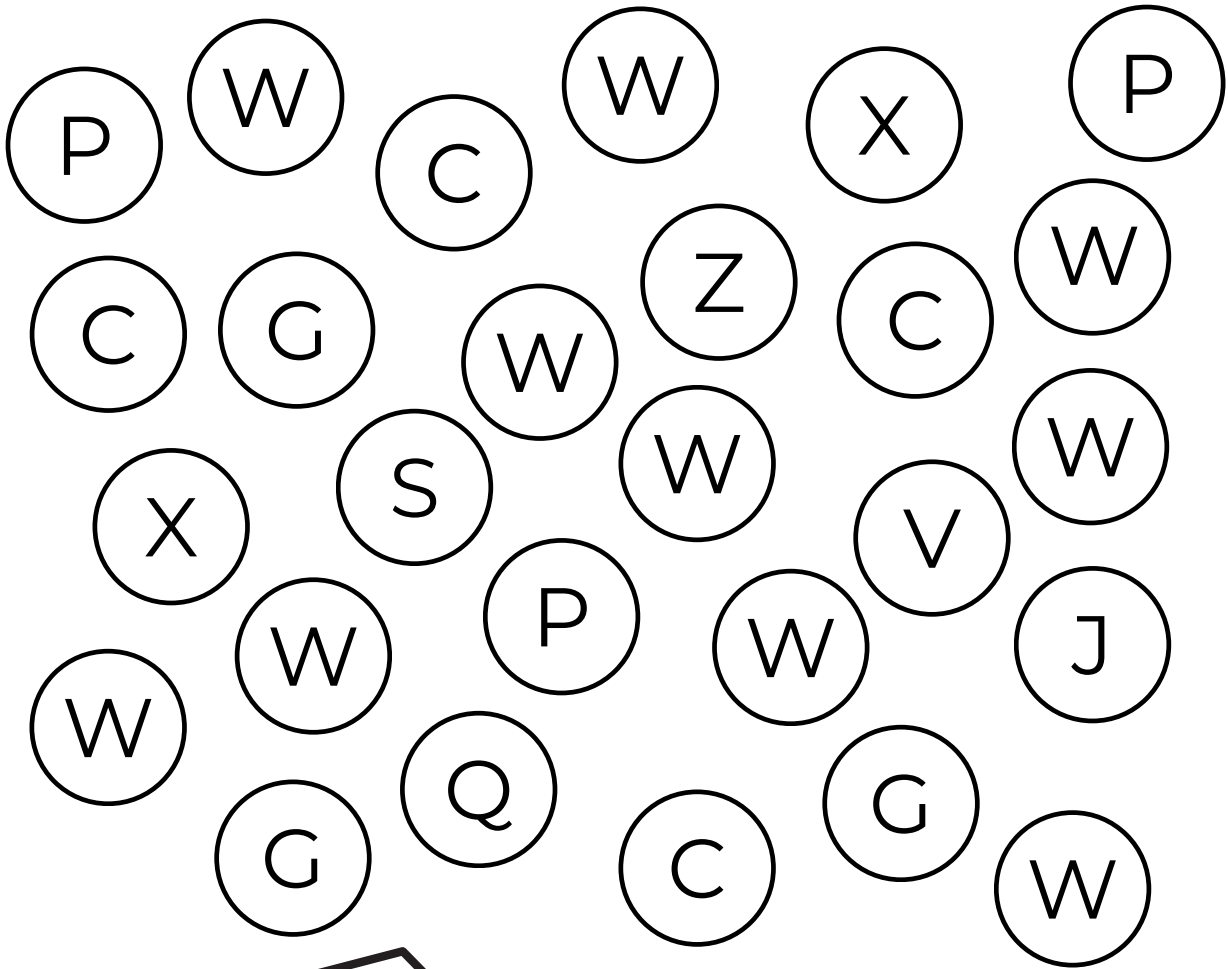

Nom _____

Date _____

Colorie la lettre w

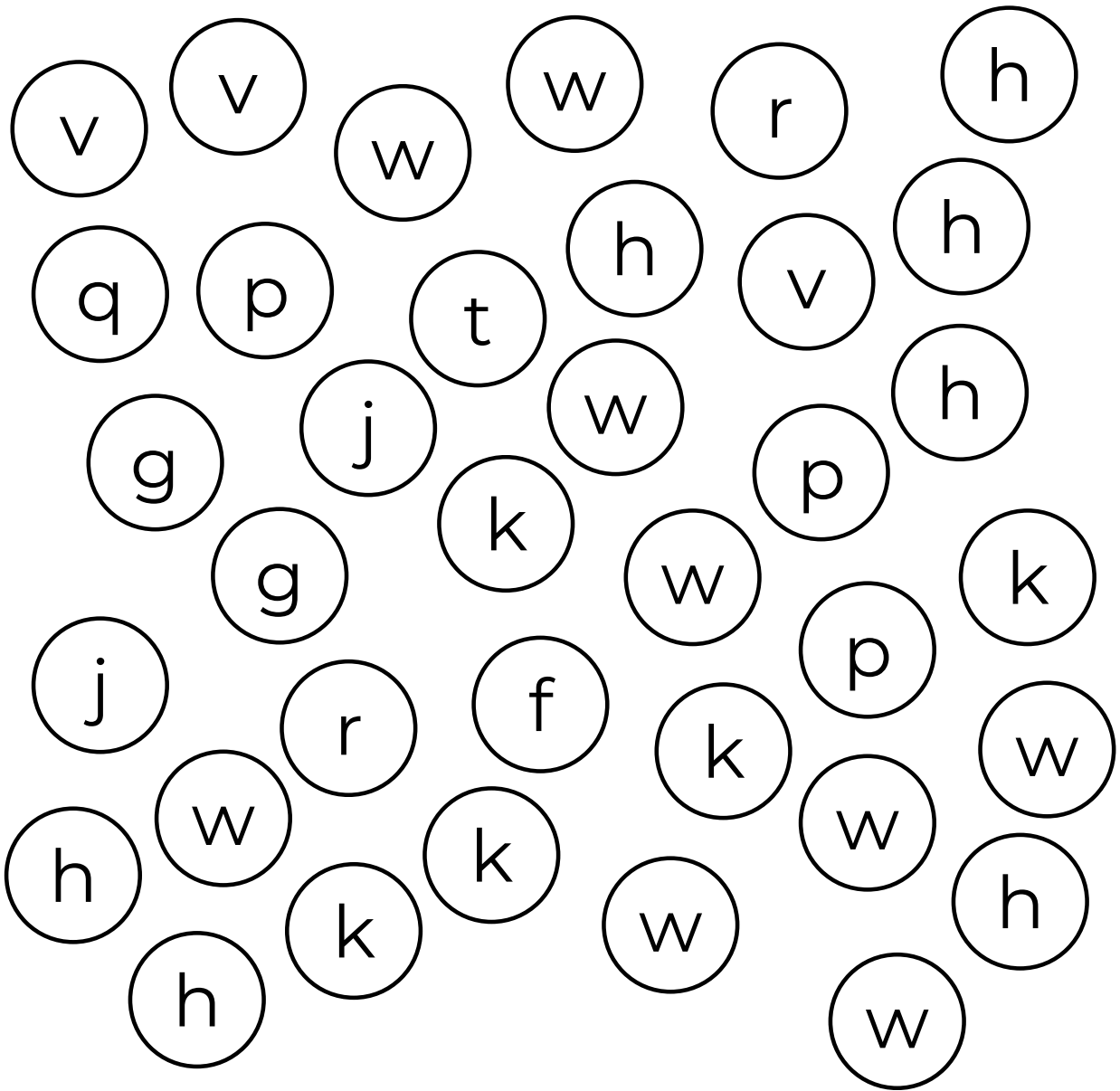

WAGON / wagon

Nom _____

Date _____

Repasse sur la lettre X / x

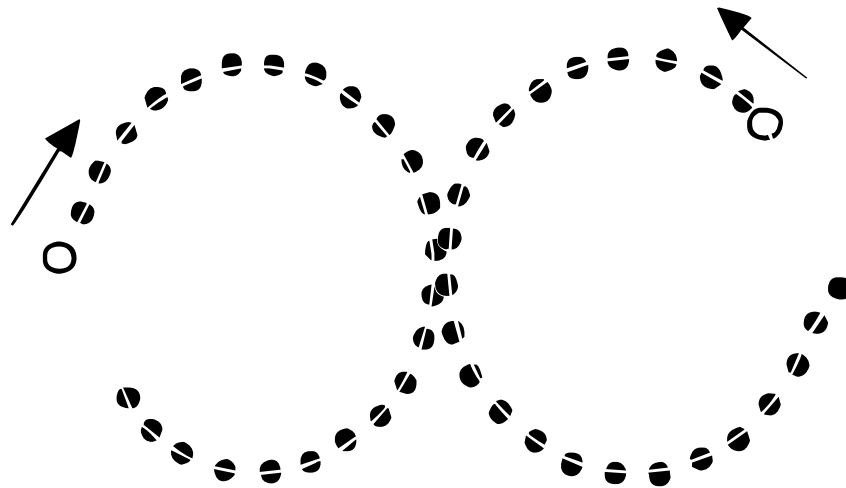

Nom _____

Date _____

Repasse sur la lettre X / x

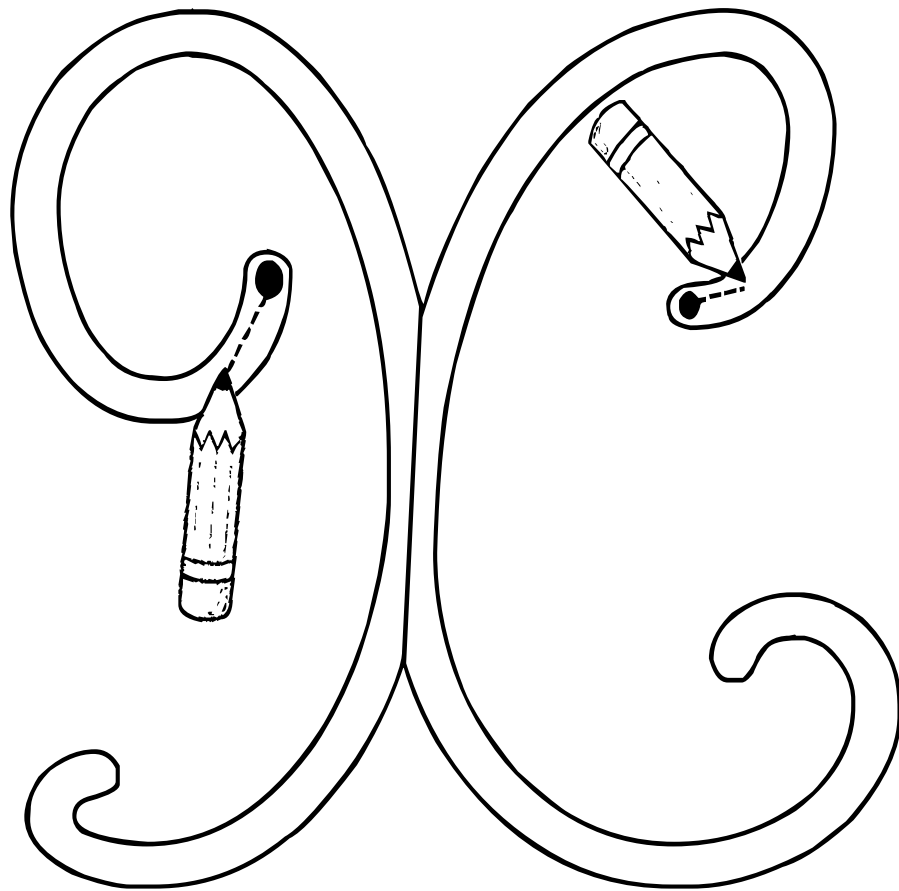

Nom _____

Date _____

Repasse sur la lettre X / x

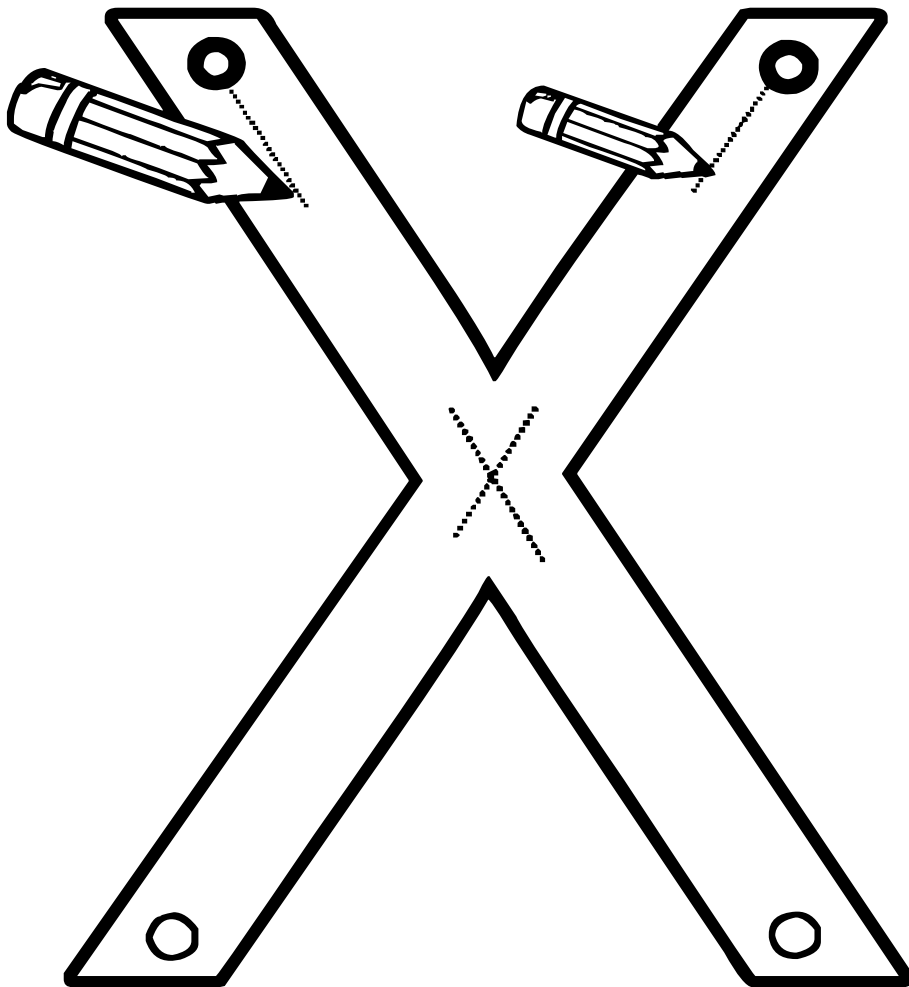

Nom _____

Date _____

Ecris la lettre X / x



Nom _____

Date _____

Ecris la lettre X / x

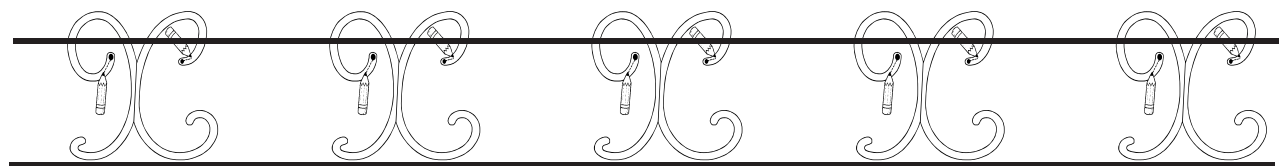
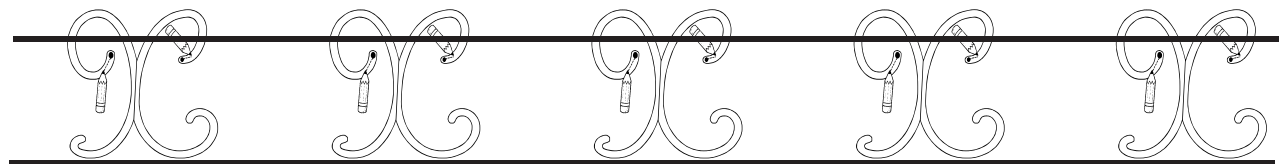
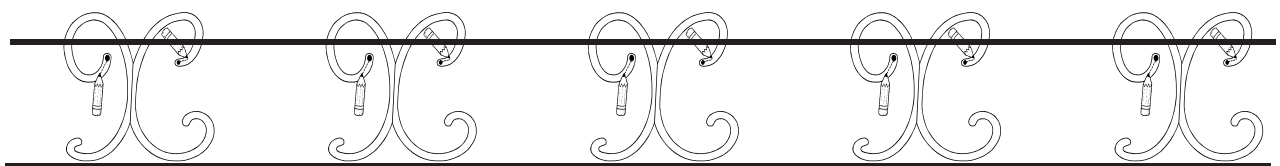
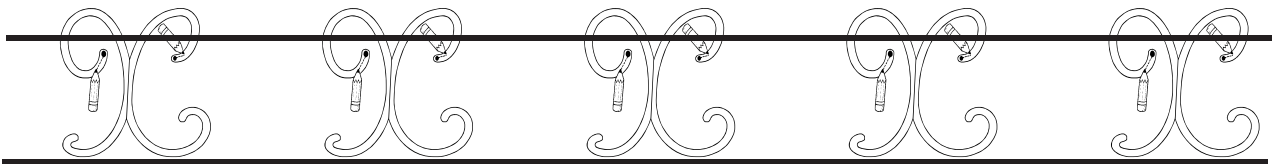
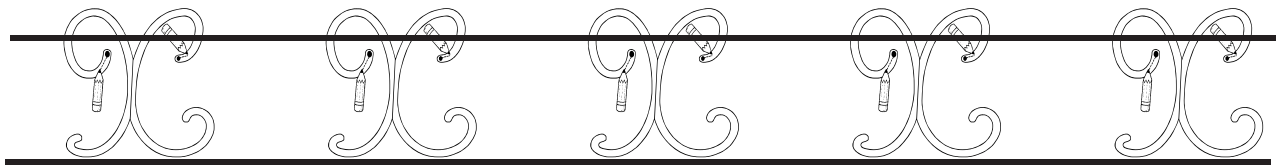
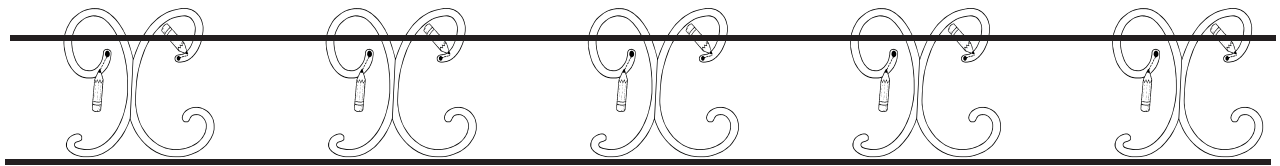
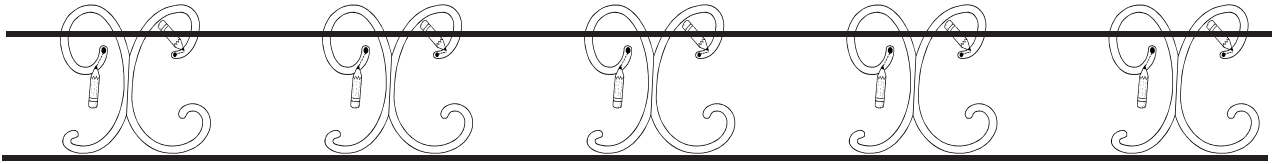

Nom _____ Date _____

Ecris la lettre X/x

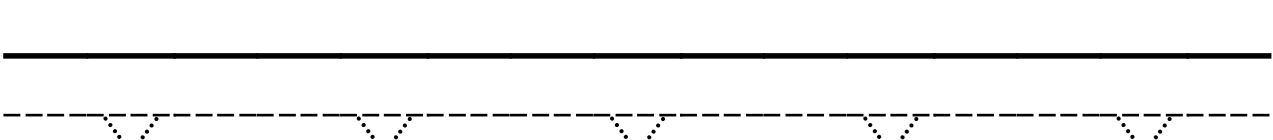
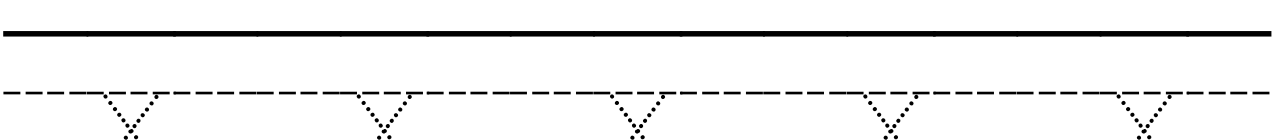
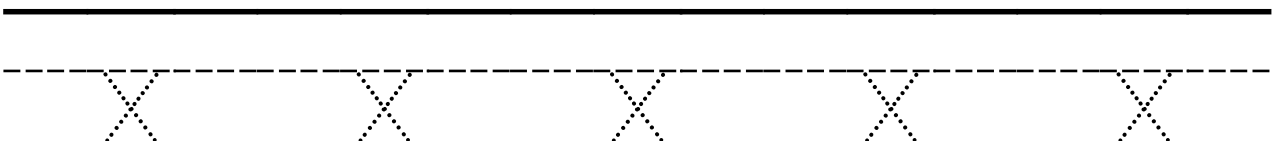
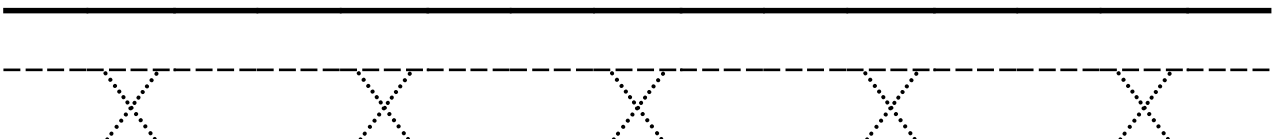
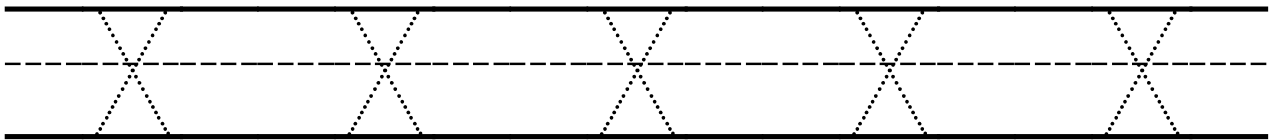
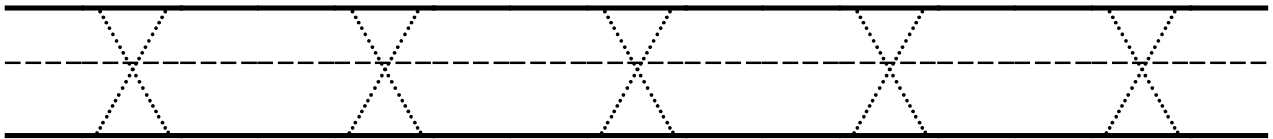
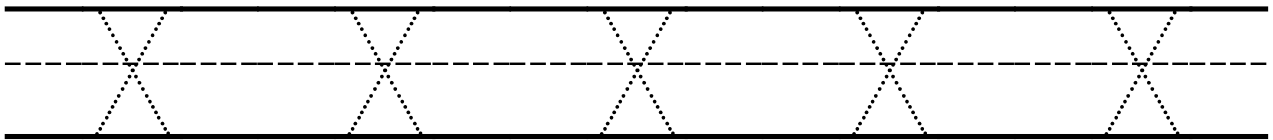
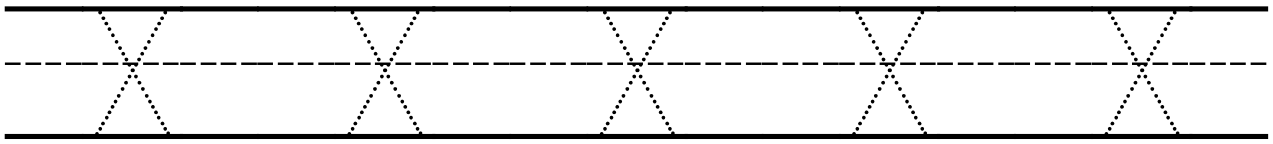

Nom _____ Date _____

Ecris la lettre X/x

X

X

X

X

X

Handwriting practice lines for uppercase X. Each set consists of a solid top line, a dashed middle line, and a solid bottom line. There are two such sets of lines provided for practice.

x

x

x

x

x

Handwriting practice lines for lowercase x. Each set consists of a solid top line, a dashed middle line, and a solid bottom line. There are two such sets of lines provided for practice.

Nom _____ Date _____

Colorie la lettre X

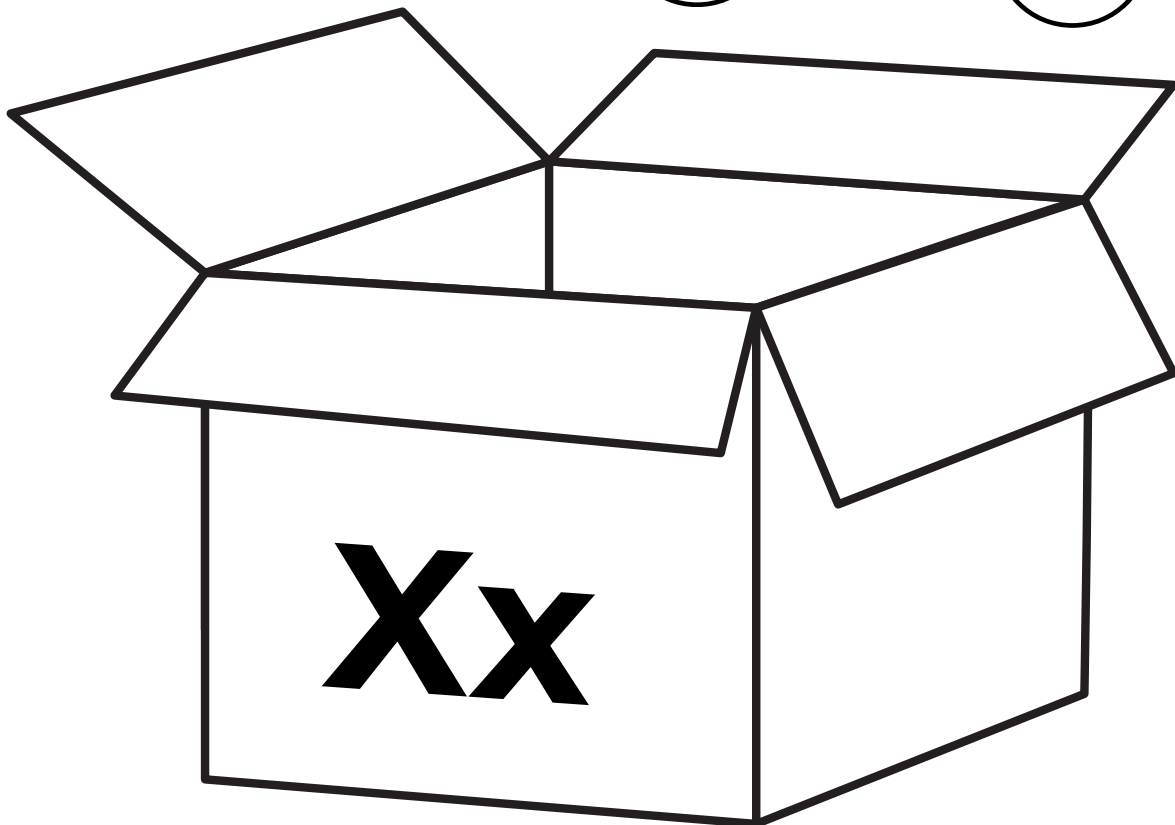
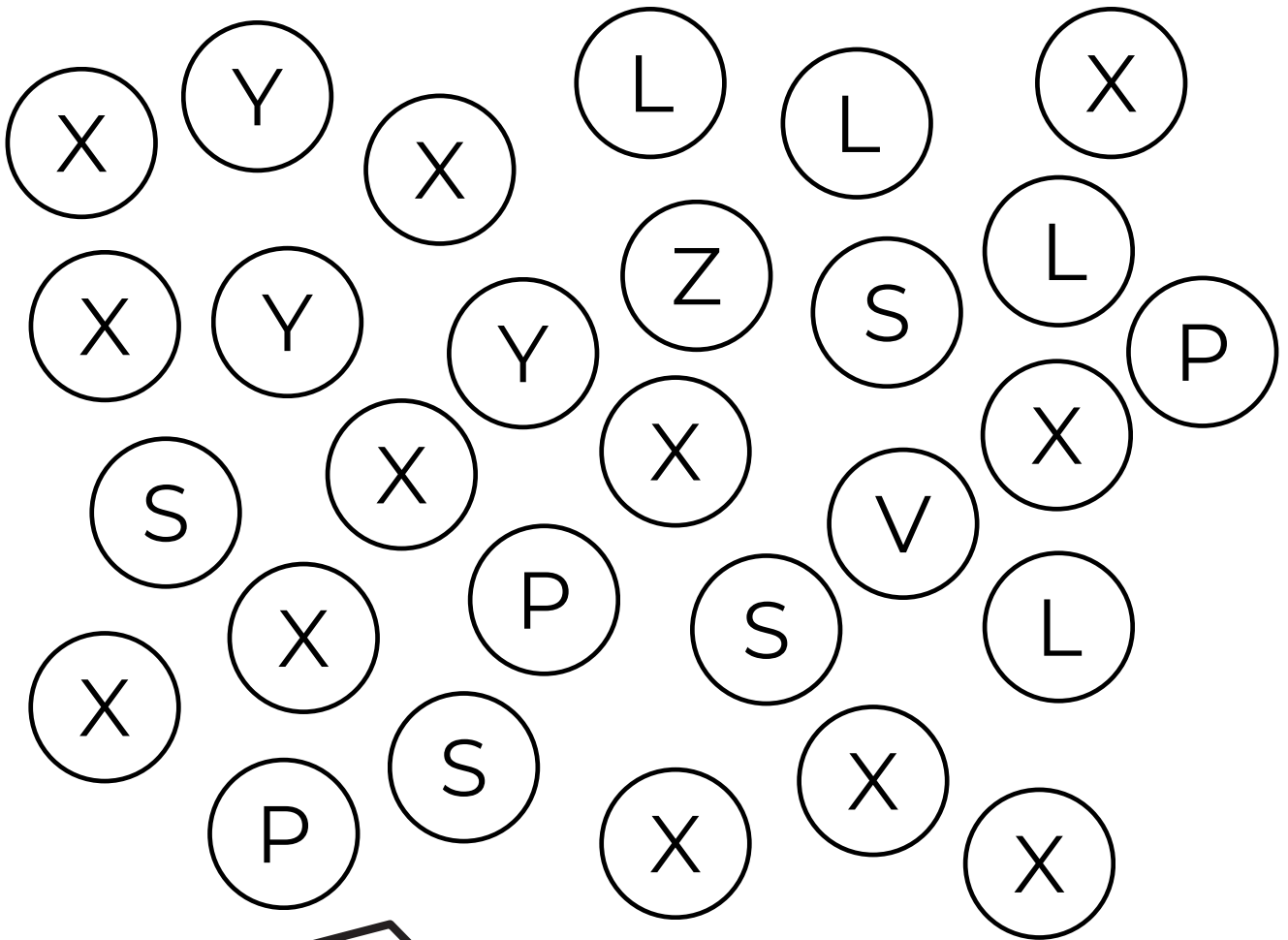

Nom _____

Date _____

Colorie la lettre x

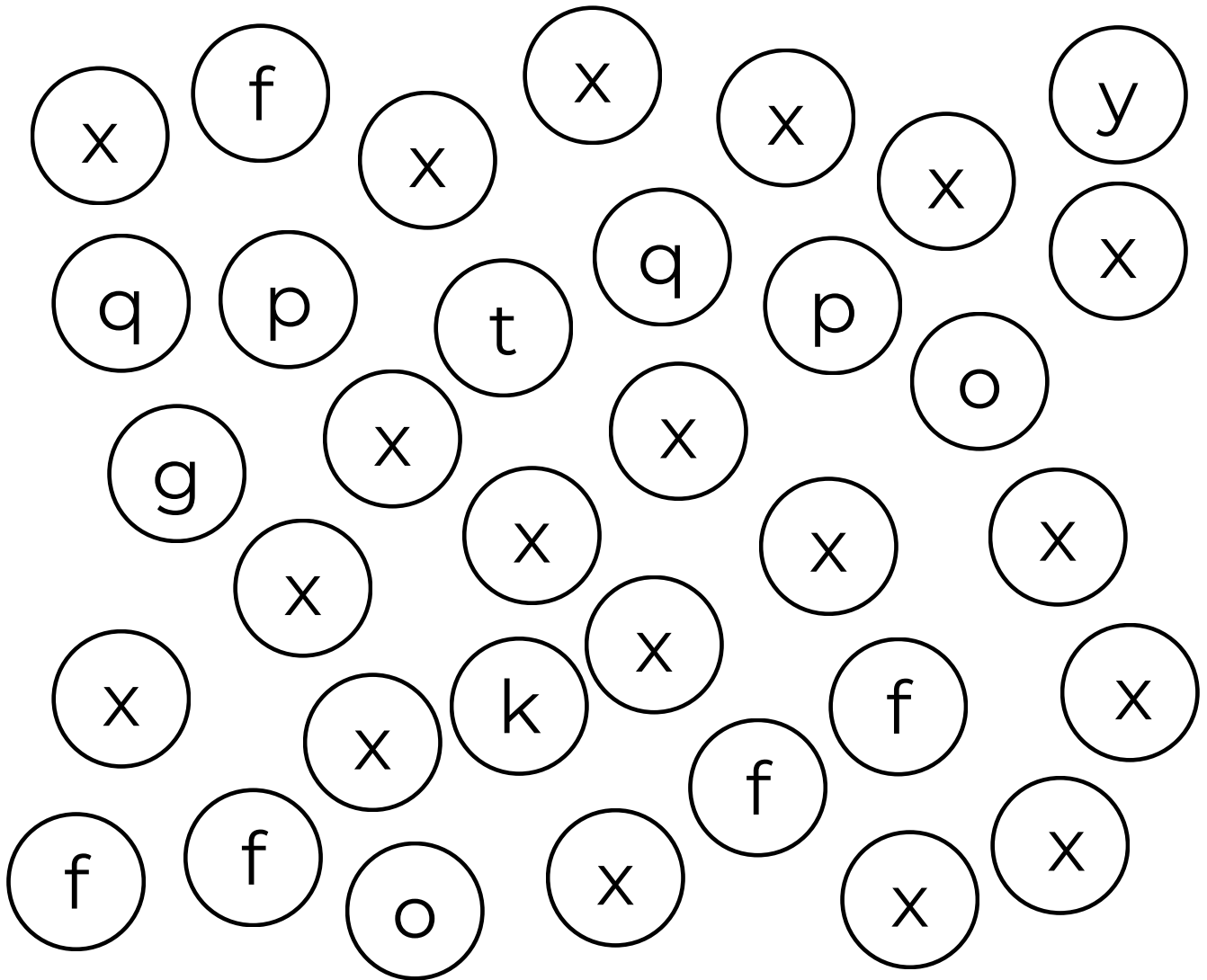

XYLOCOPE / xylocope

(type d'abeille charpentière)

Nom _____

Date _____

Repasse sur la lettre Y / y

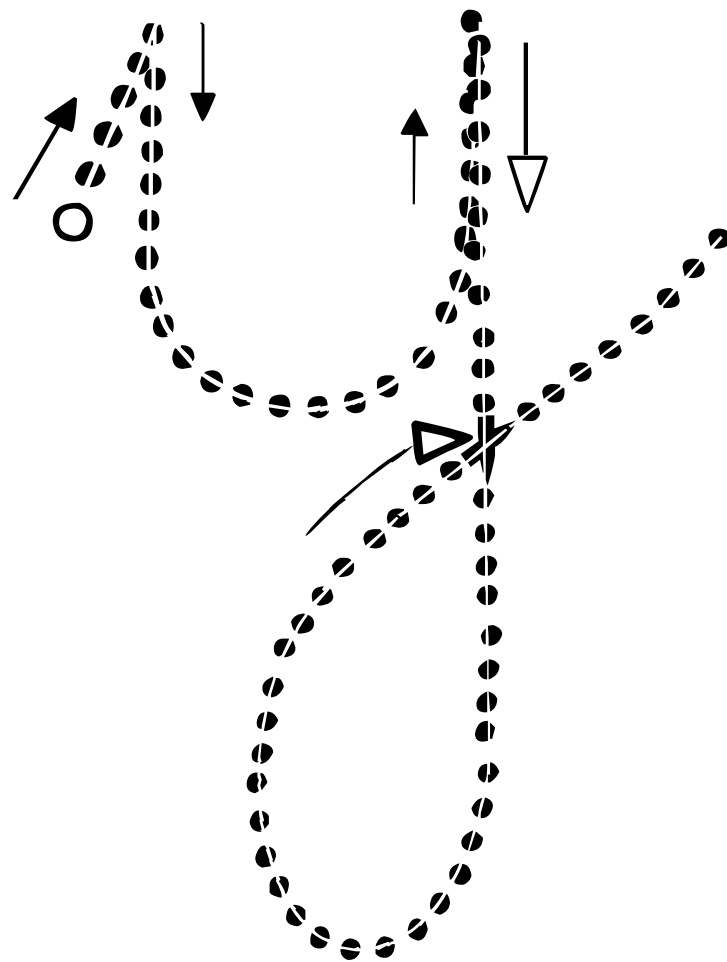

Nom _____

Date _____

Repasse sur la lettre Y / y

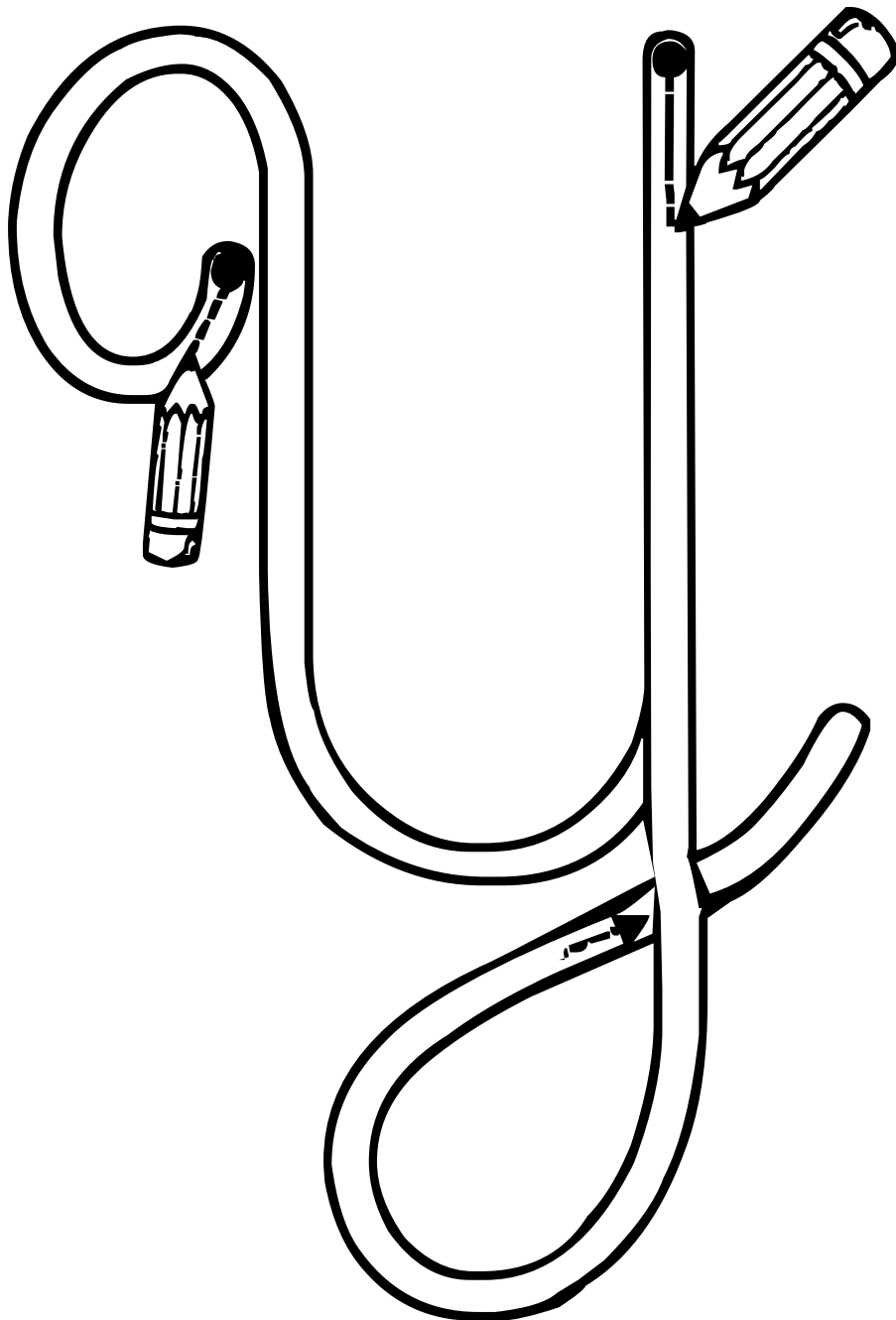

Nom _____

Date _____

Repasse sur la lettre Y / y

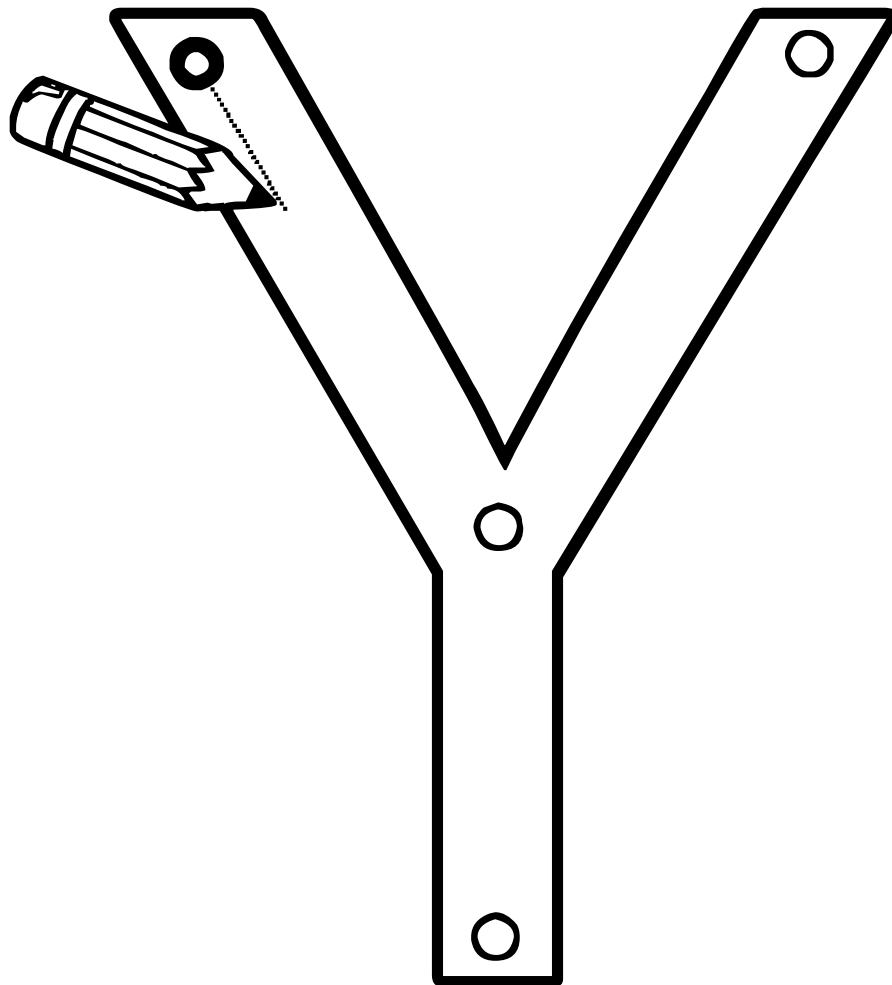

Nom _____

Date _____

Ecris la lettre Y / y

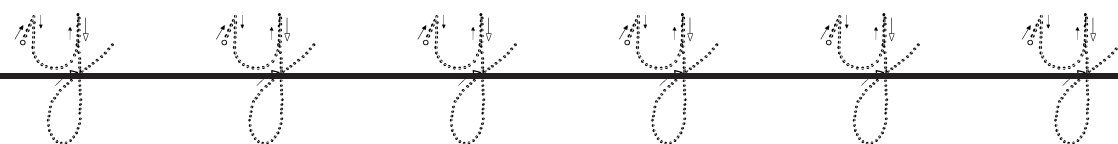
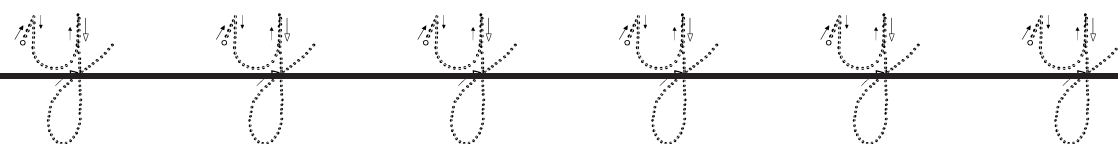
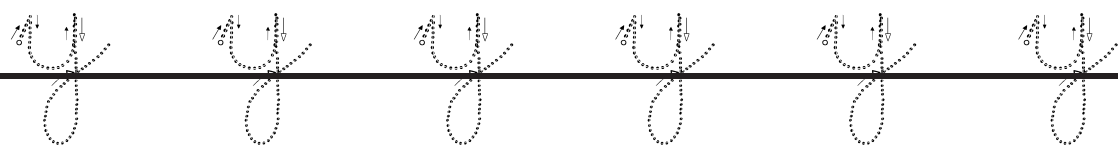
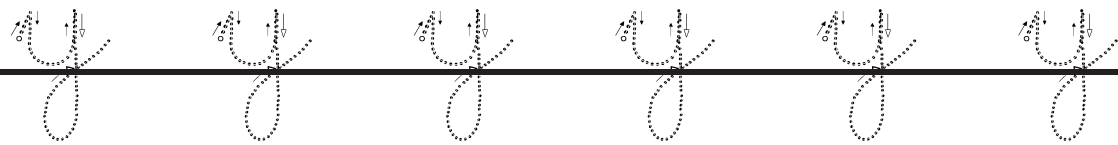
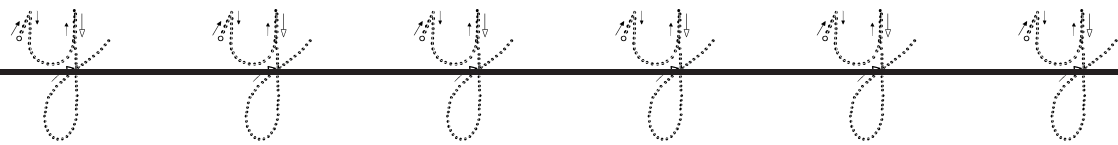

Nom _____

Date _____

Ecris la lettre Y / y

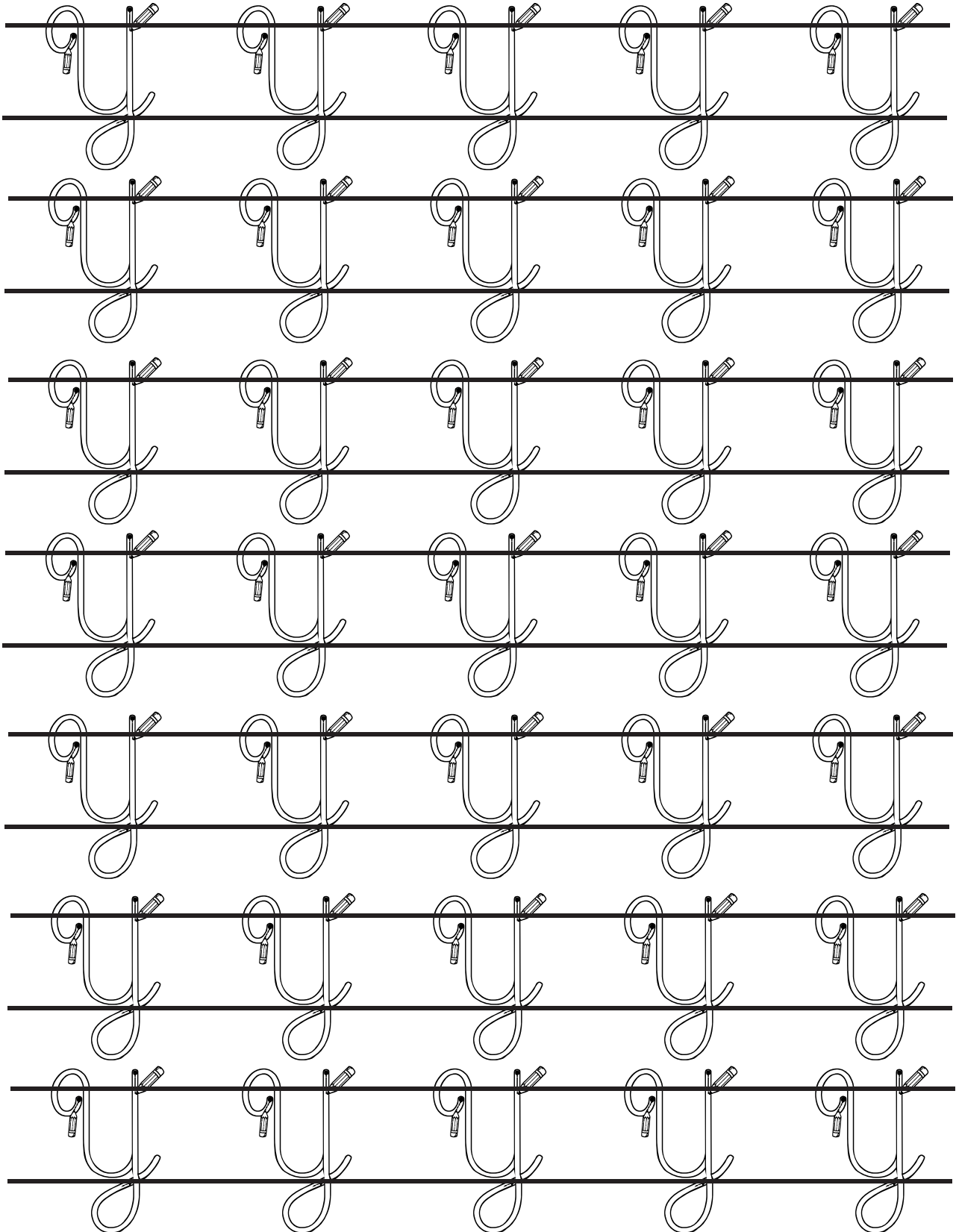

Nom _____ Date _____

Ecris la lettre Y/y

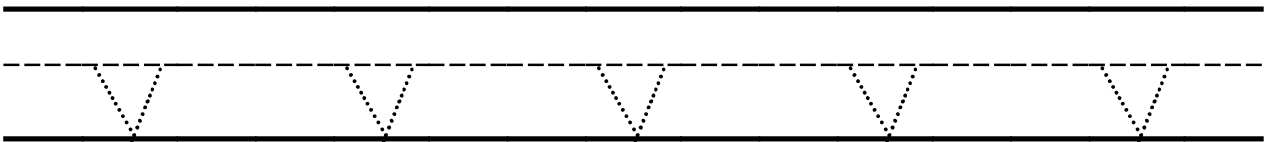
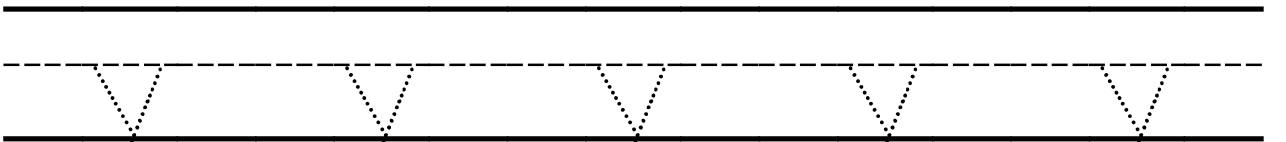
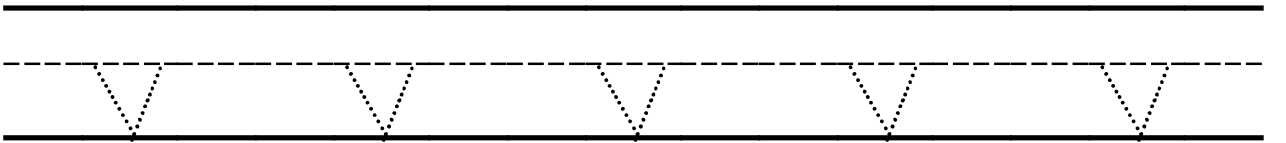
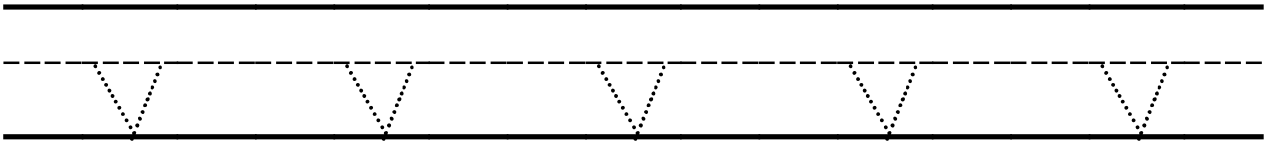
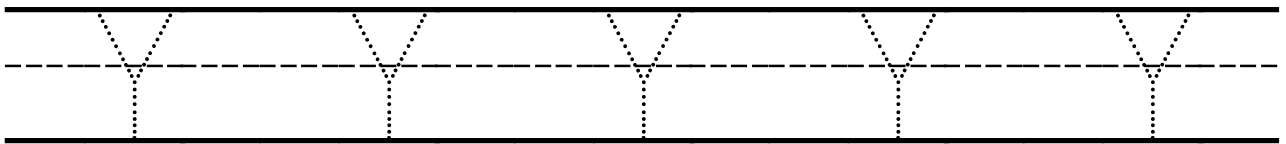
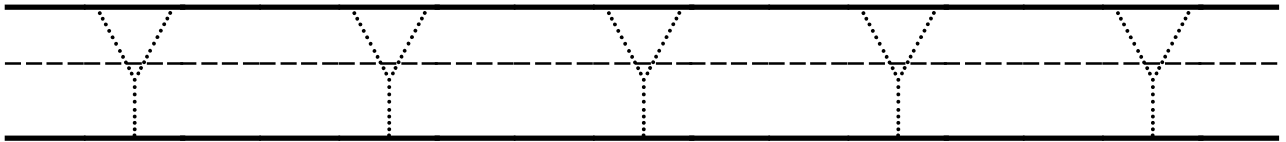
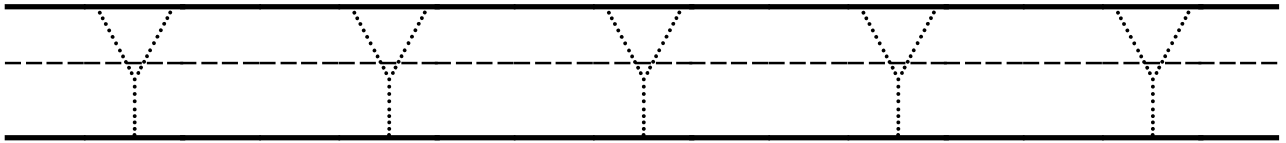
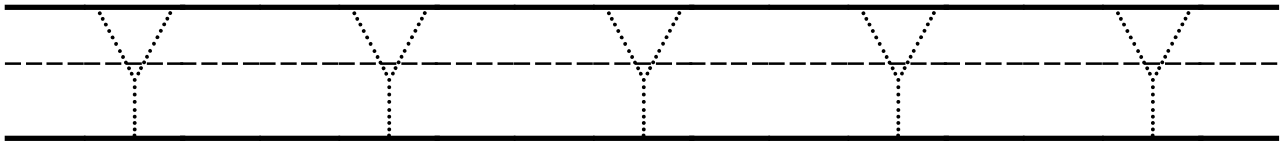

Nom _____ Date _____

Ecris la lettre Y/y

Y

Y

Y

Y

Y

Handwriting practice lines for uppercase 'Y'. Each row consists of a solid top line, a dashed middle line, and a solid bottom line. There are two such rows provided for practice.

y

y

y

y

y

Handwriting practice lines for lowercase 'y'. Each row consists of a solid top line, a dashed middle line, and a solid bottom line. There are two such rows provided for practice.

Nom _____

Date _____

Colorie la lettre Y

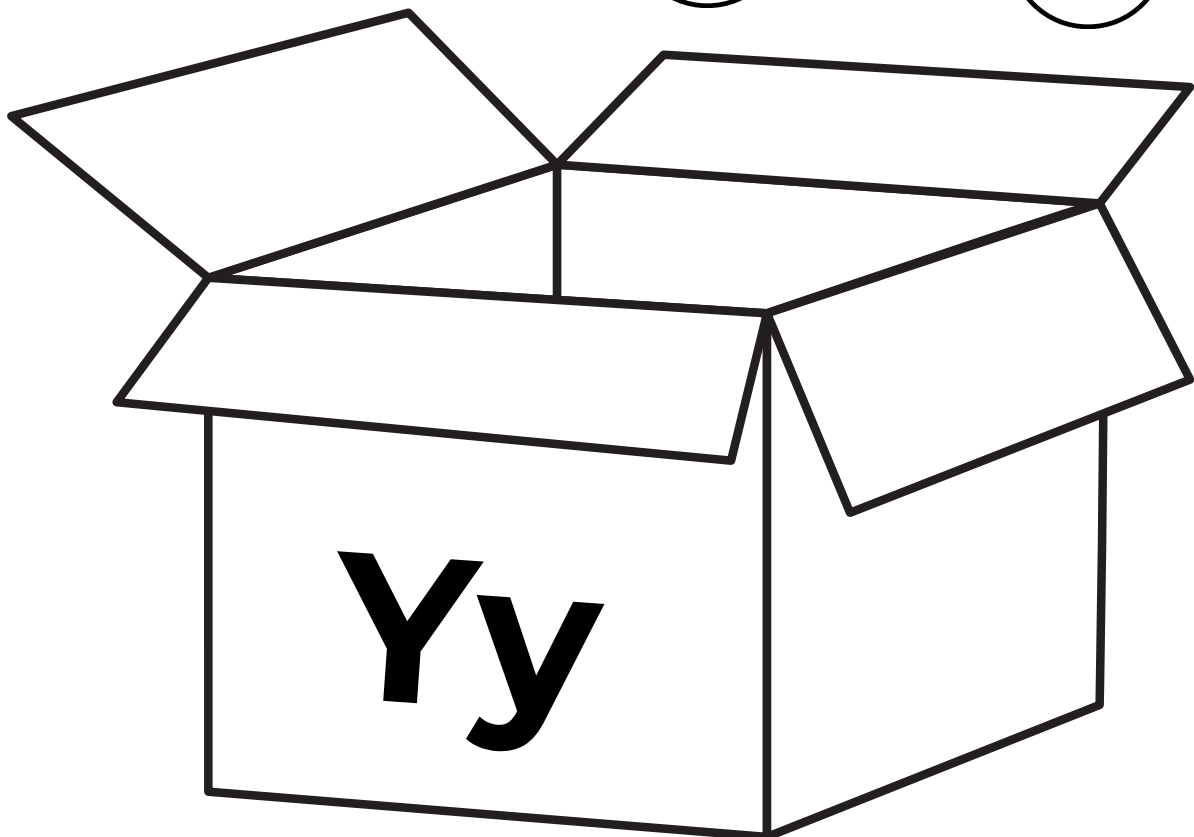
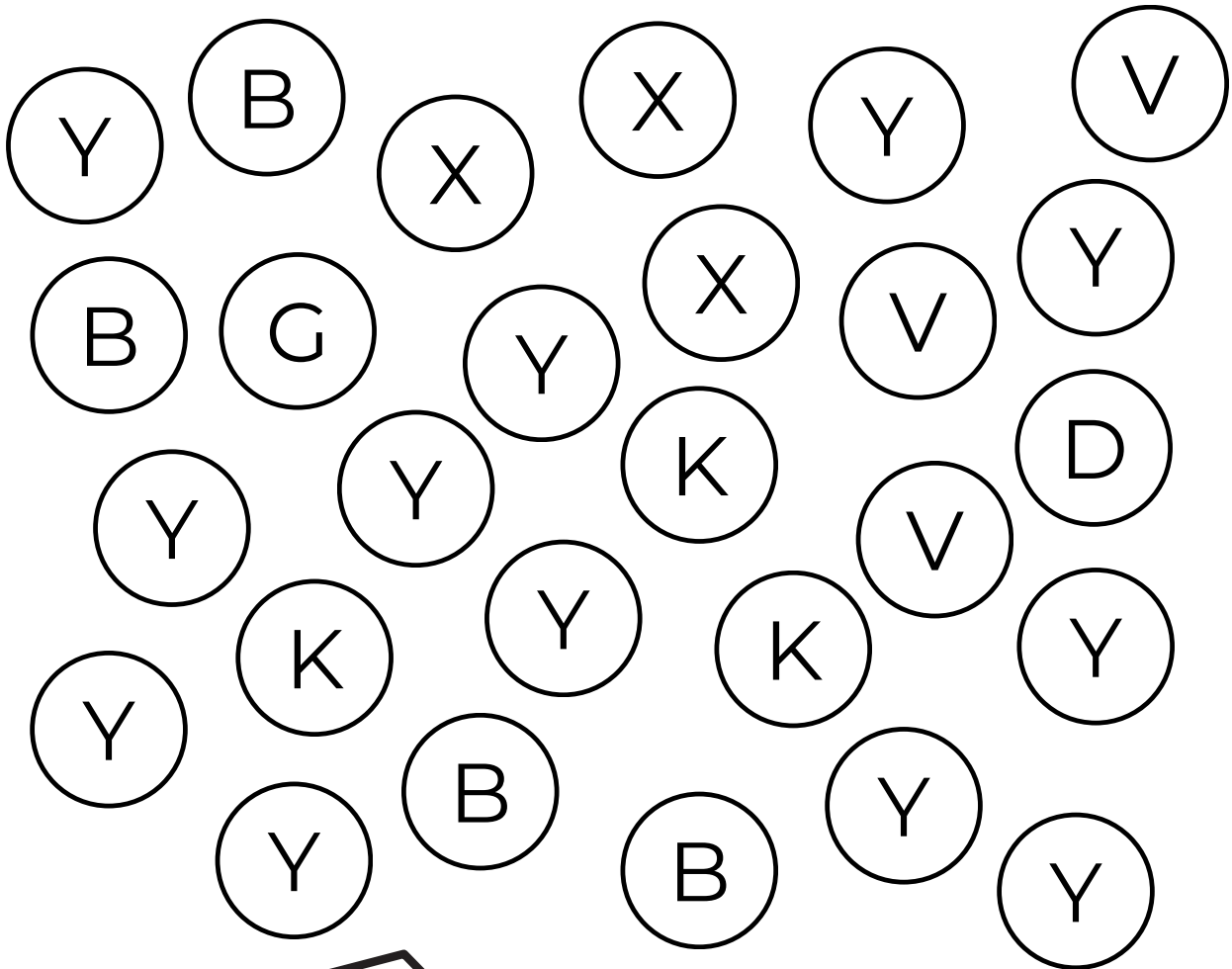

Nom _____

Date _____

Colorie la lettre y

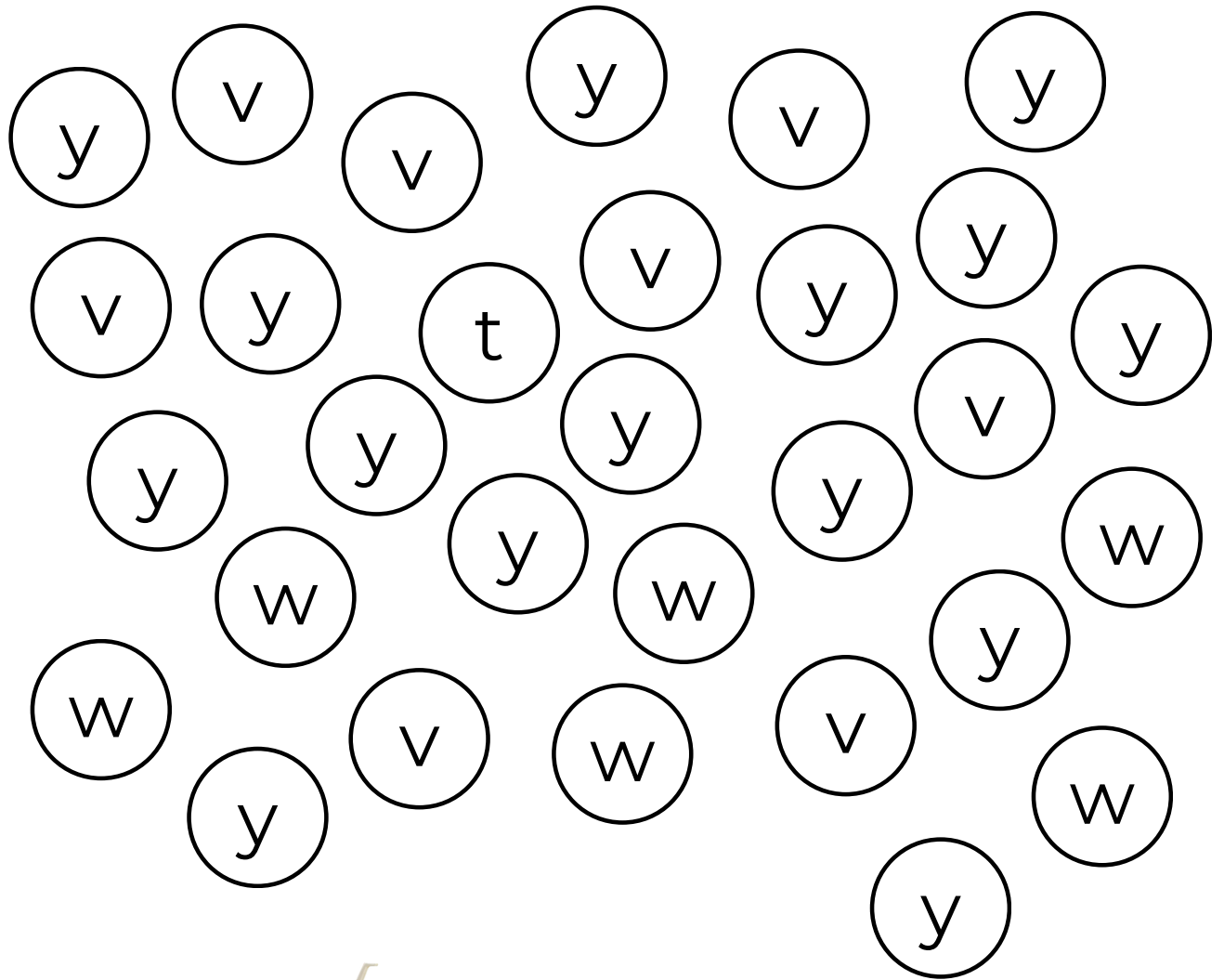

YACHT / yacht
(petit bateau)

Nom _____

Date _____

Repasse sur la lettre Z / z

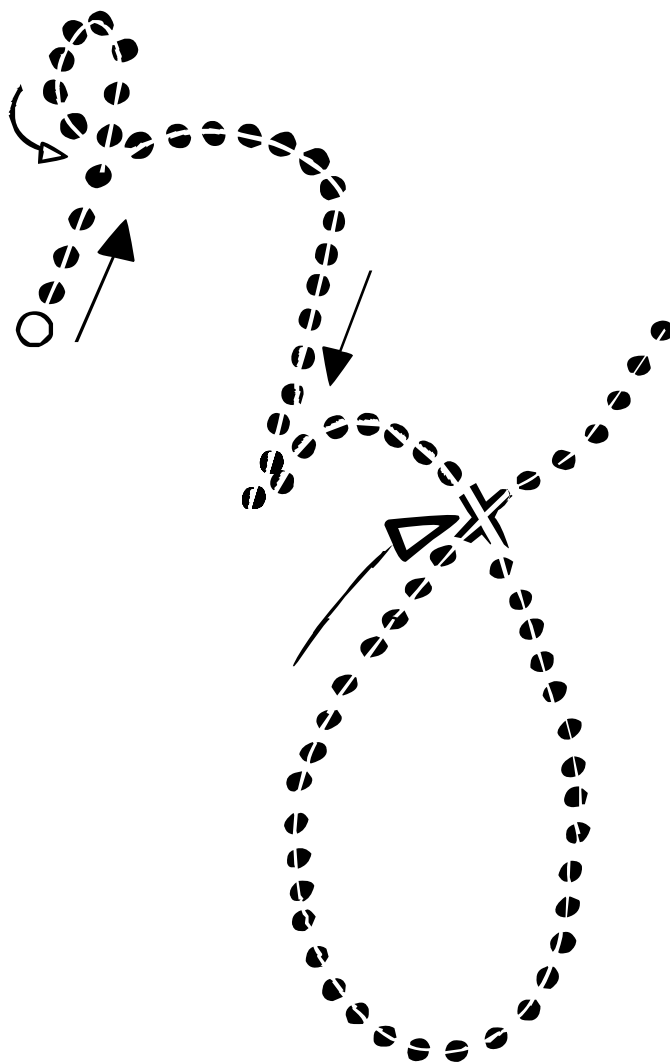

Nom _____

Date _____

Repasse sur la lettre Z / z

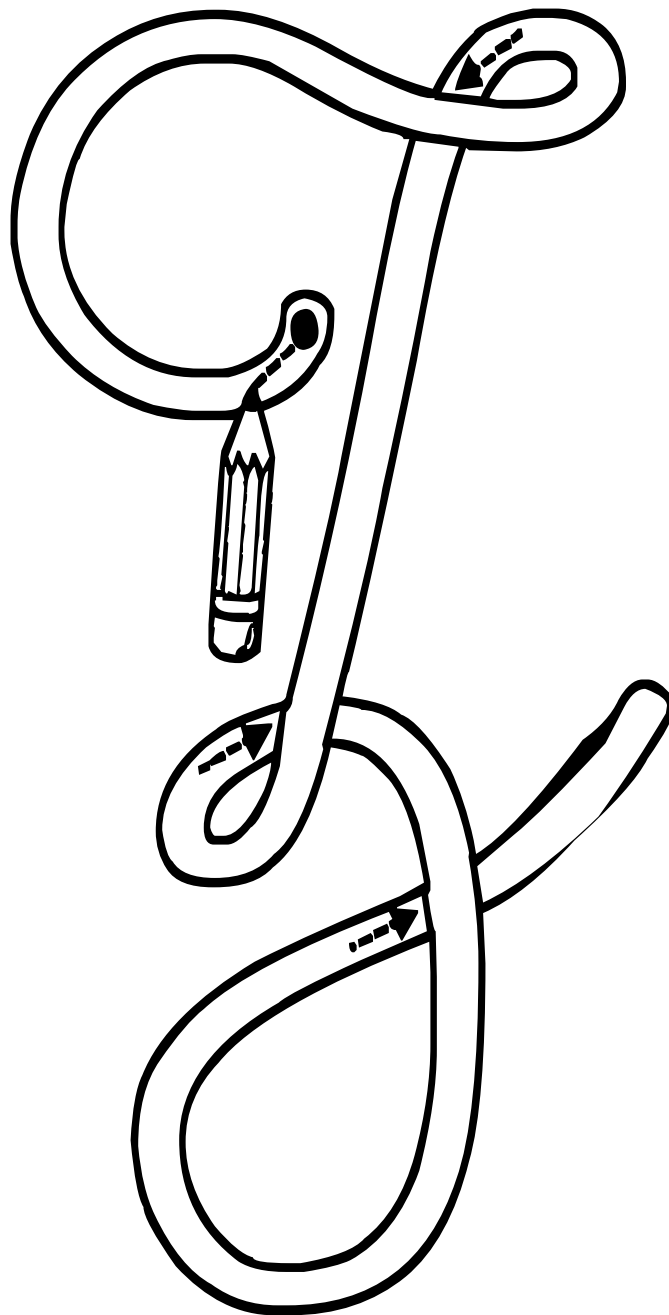

Nom _____

Date _____

Repasse sur la lettre Z / z

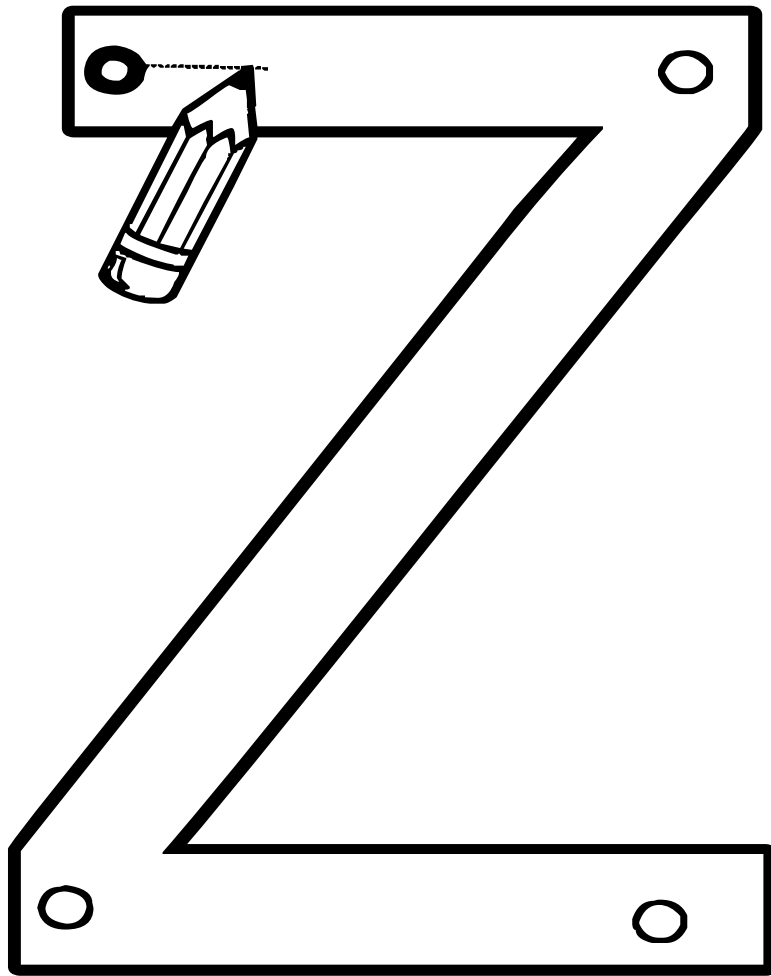

Nom _____

Date _____

Ecris la lettre Z / z

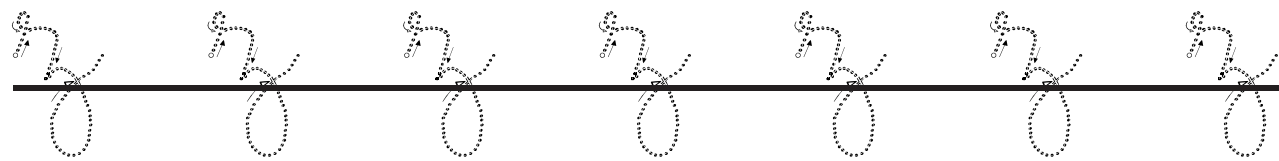
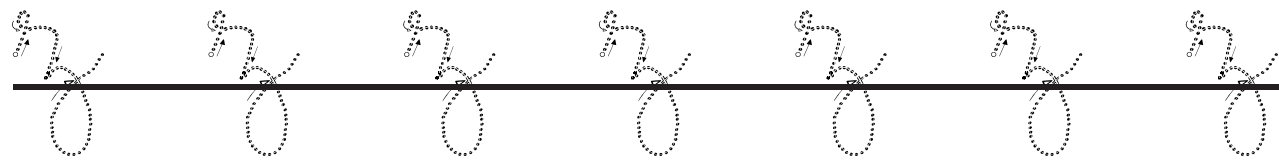
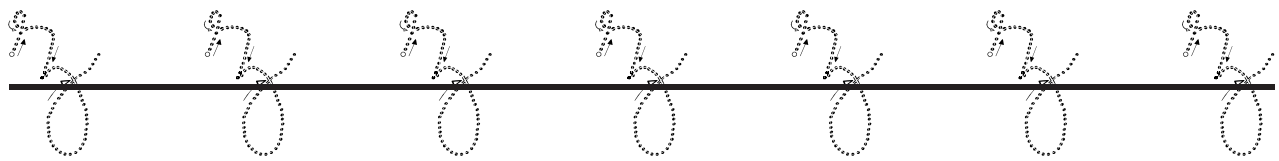
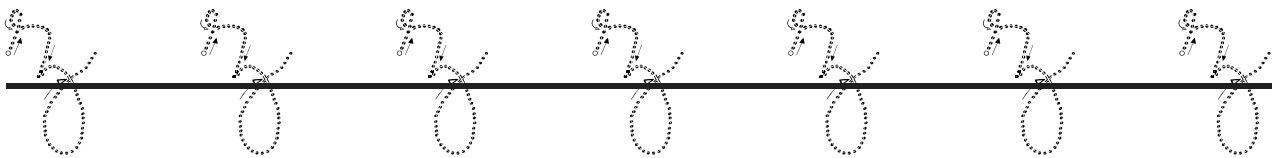
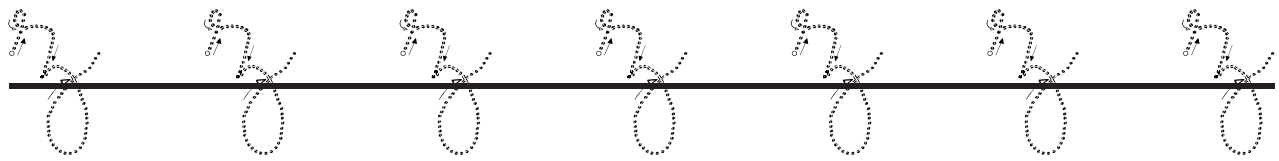
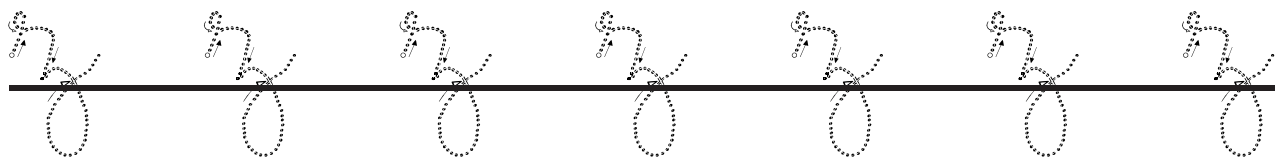
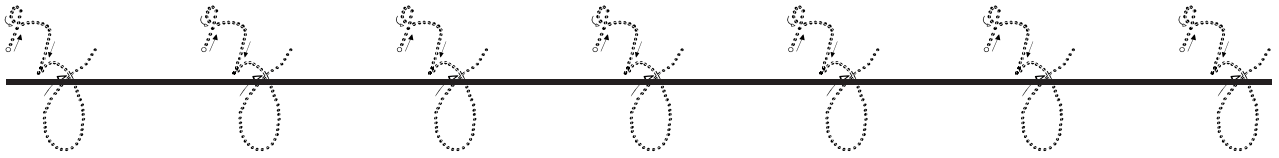

Nom _____

Date _____

Ecris la lettre Z / z

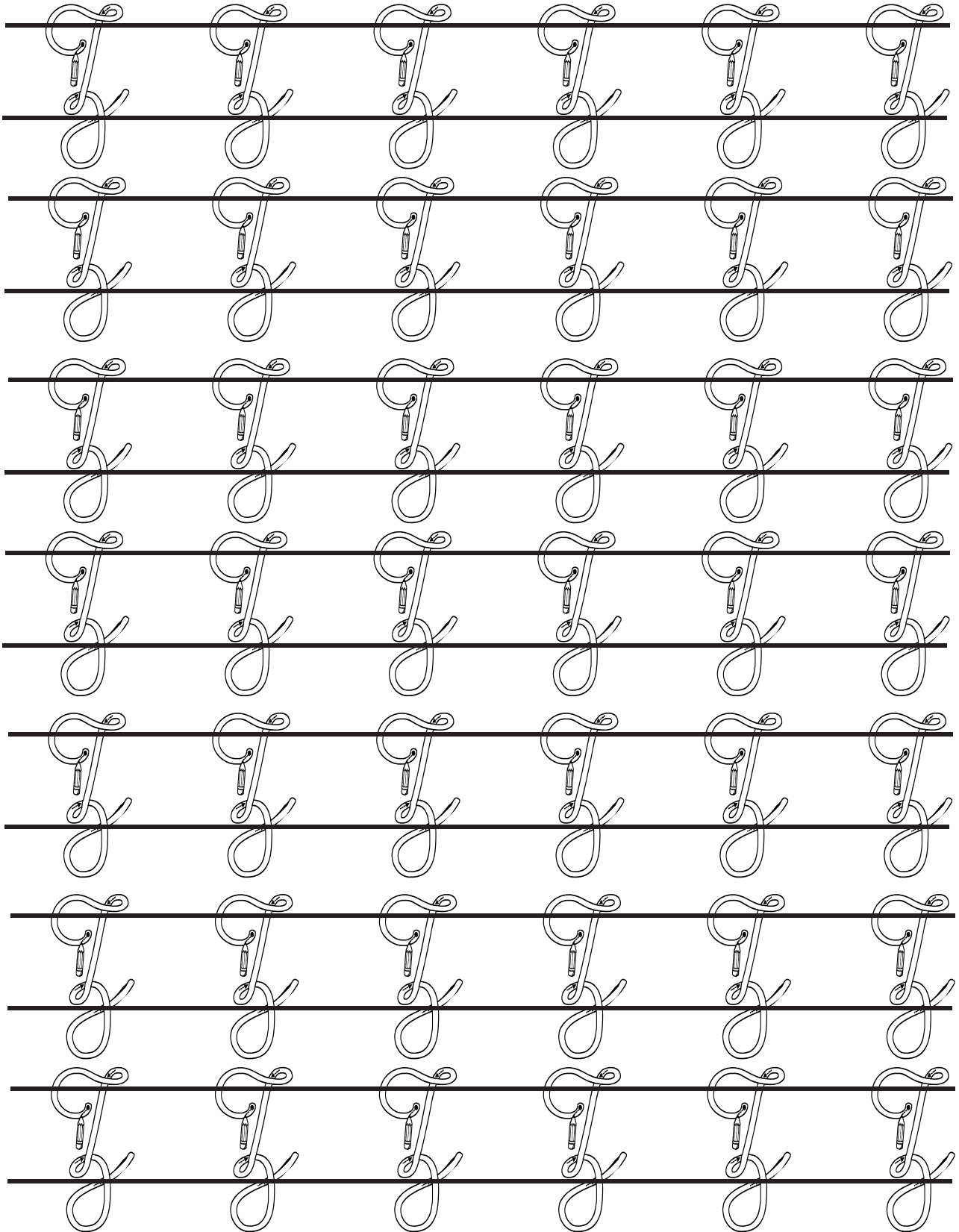

Nom _____

Date _____

Ecris la lettre Z/z

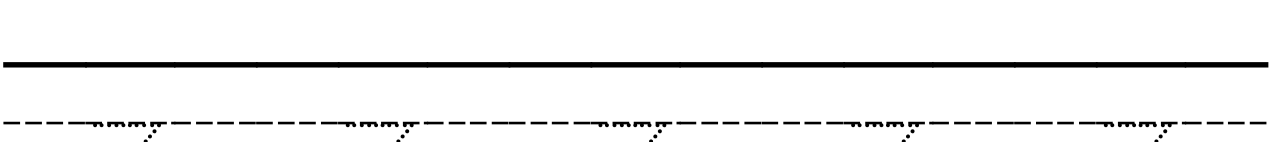
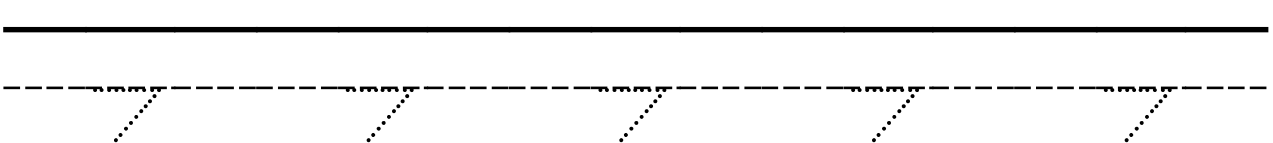
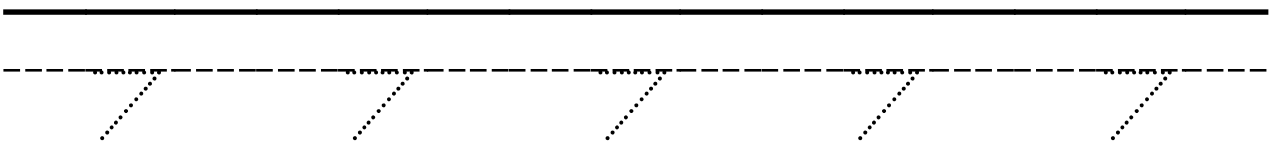
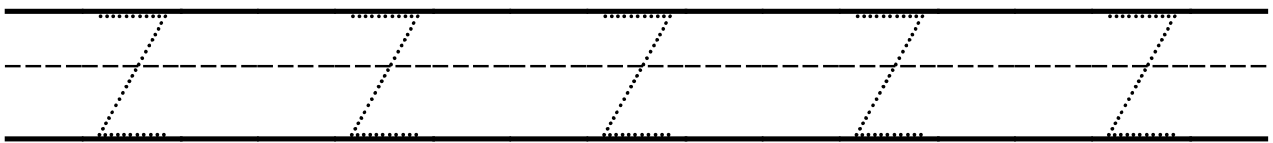
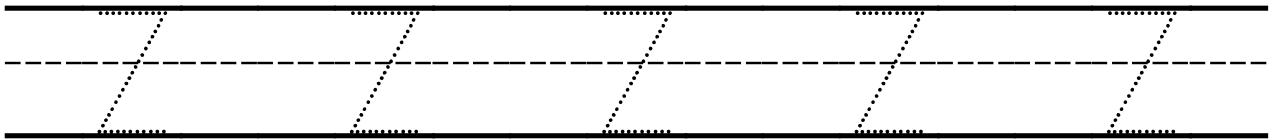
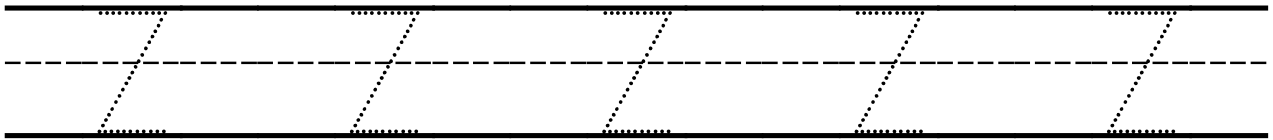
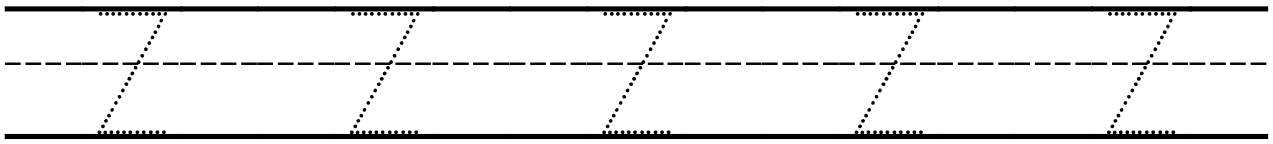

Nom _____ Date _____

Ecris la lettre Z/z

Z Z Z Z Z

Handwriting practice lines for uppercase Z. Each row consists of a solid top line, a dashed middle line, and a solid bottom line.

z z z z z

Handwriting practice lines for lowercase z. Each row consists of a solid top line, a dashed middle line, and a solid bottom line.

Nom _____

Date _____

Colorie la lettre Z

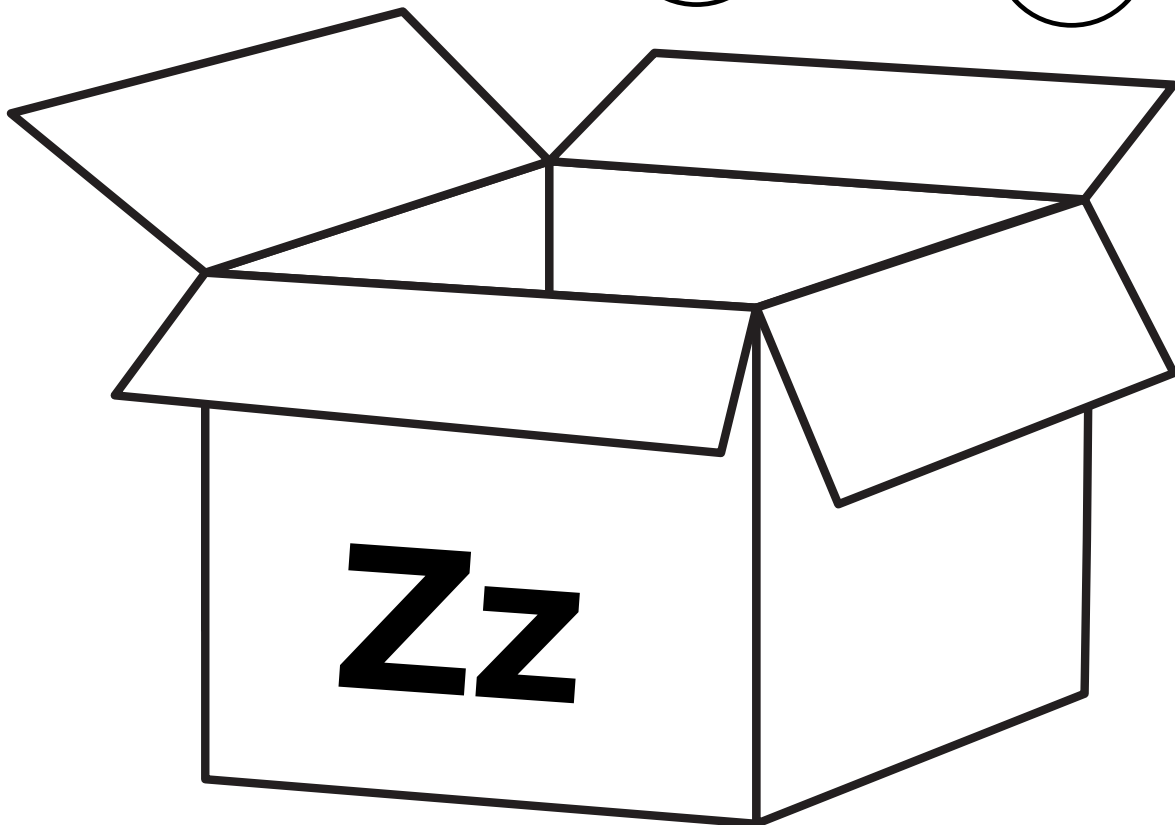
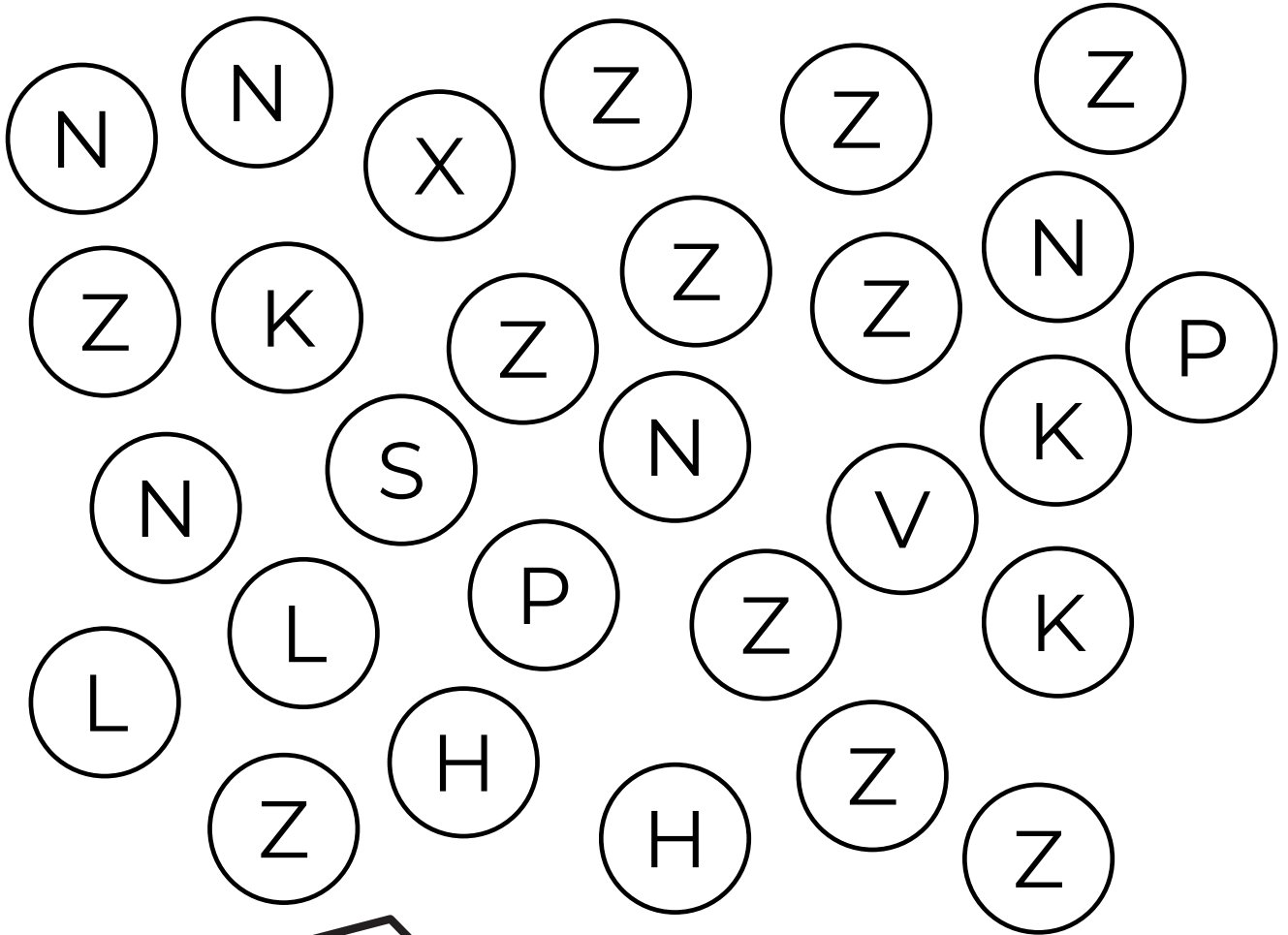

Nom _____ Date _____

Colorie la lettre z

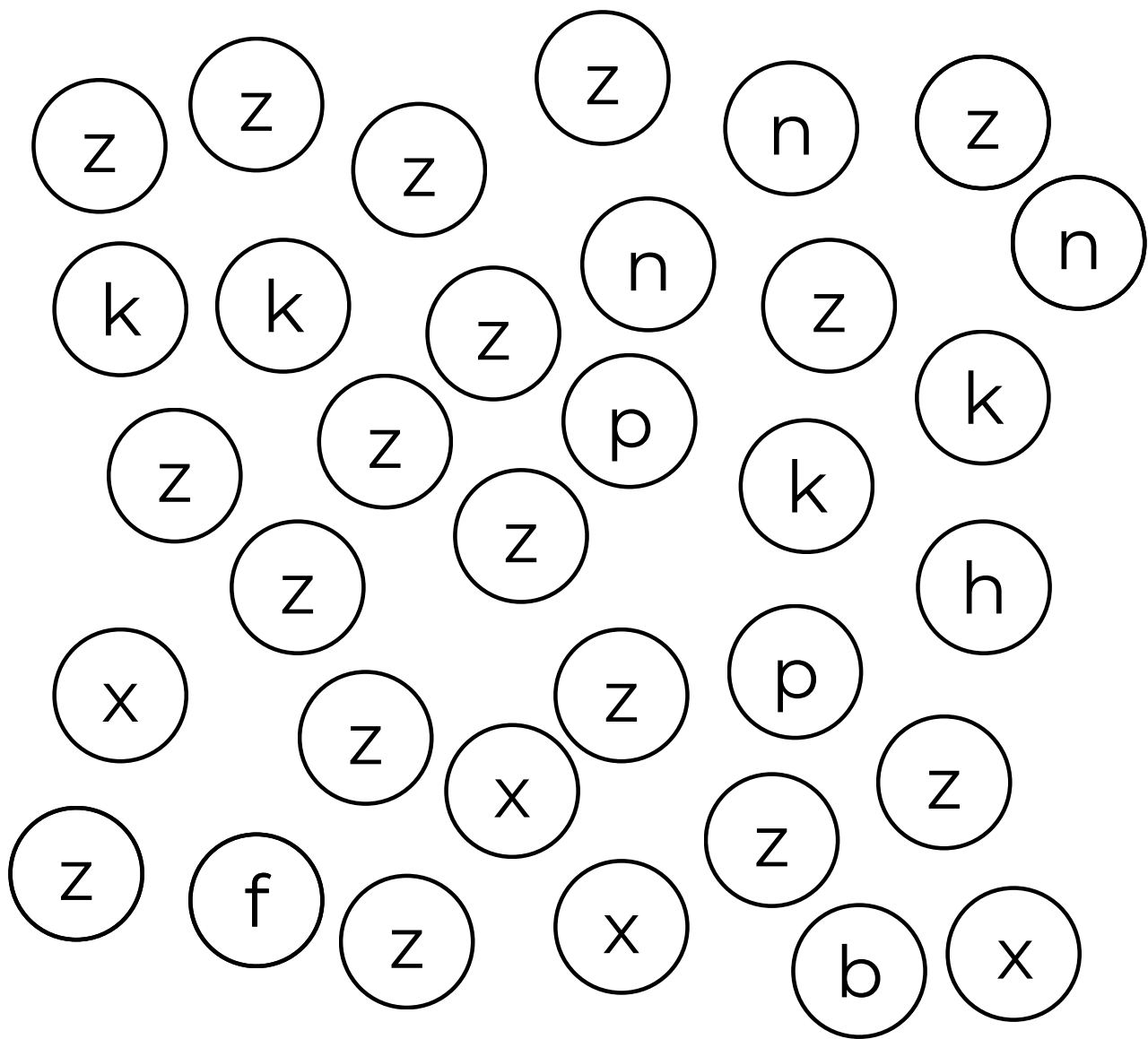











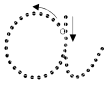

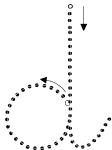

ZENITH / zénith

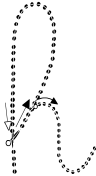

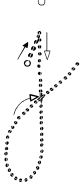
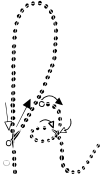
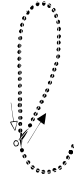
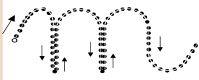
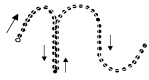
Nom _____ Date: _____

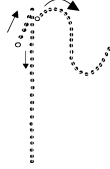
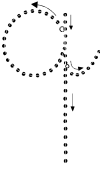
MON ALPHABET

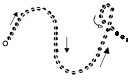
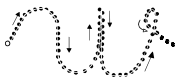
Repasse sur les lettres de l'alphabet

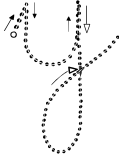
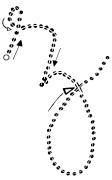

Nom _____

Date: _____

MON ALPHABET

Repasse sur les lettres de l'alphabet

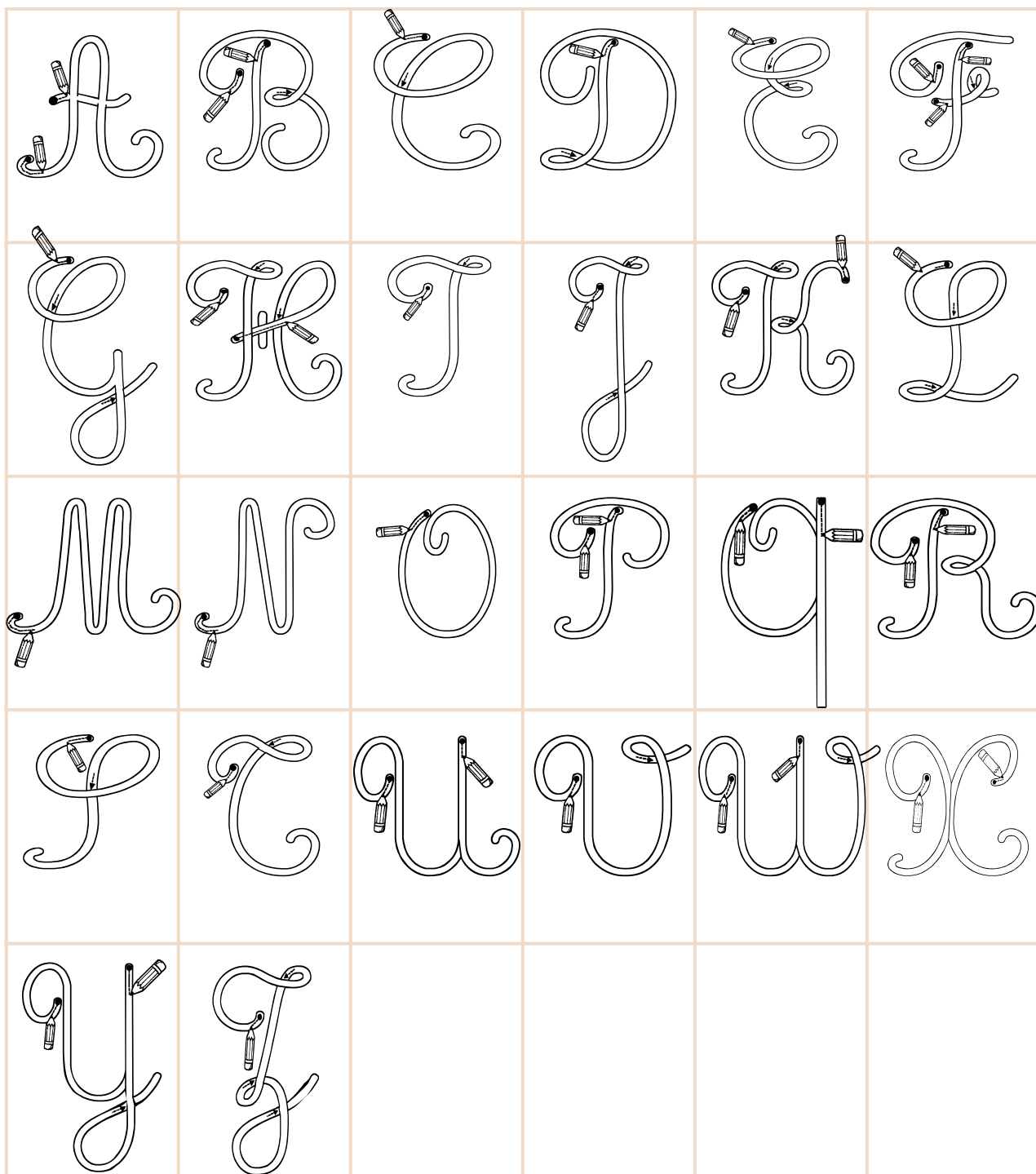

Nom _____

Date: _____

MON ALPHABET

Repasse sur les lettres de l'alphabet

A	B	C	D	E	F
G	H	I	J	K	L
M	N	O	P	Q	R
S	T	U	V	W	X
Y	Z				

Nom _____

Date: _____

MON ALPHABET

Repasse sur les lettres de l'alphabet

a	b	c	d	e	f
g	h	i	j	k	l
m	n	o	p	q	r
s	t	u	v	w	x
y	z				

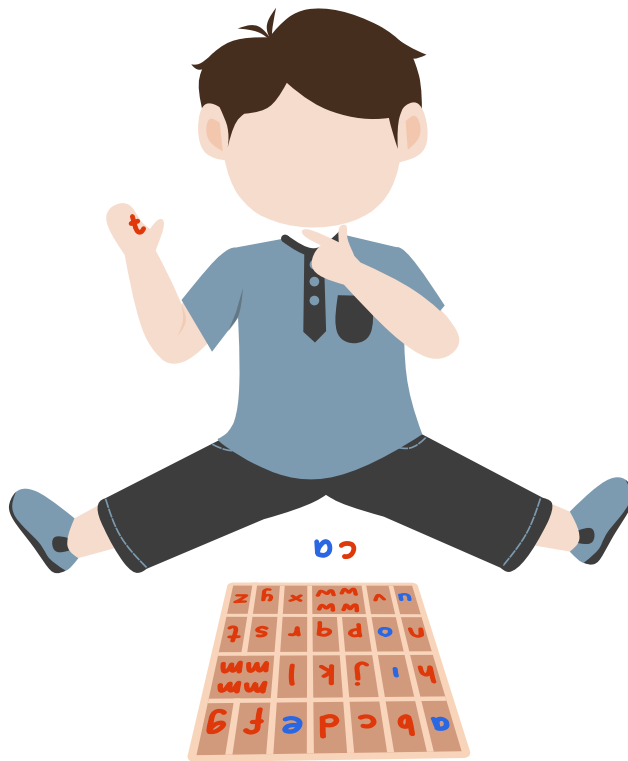

Toute reproduction totale ou partielle est strictement interdite. Toute diffusion de l'œuvre hors cadre privé est interdite sans autorisation des éditions Ummaty Books

Septembre 2023 - Edition Ummaty Books
ISBN 978-2-490990-09-2

Loi n°49-956 de 16 juillet 1949 sur les publications destinées à la jeunesse modifiée par la loi n°2011-525 du 17 mai 2011



CERTIFICAT DE RÉUSSITE

décerné à :

pour son travail assidu tout au long de ce livret et
pour son excellente connaissance de l'alphabet

