

The 100 Best

Drawing

WorkSheets

For Kids

(A4 Printable)

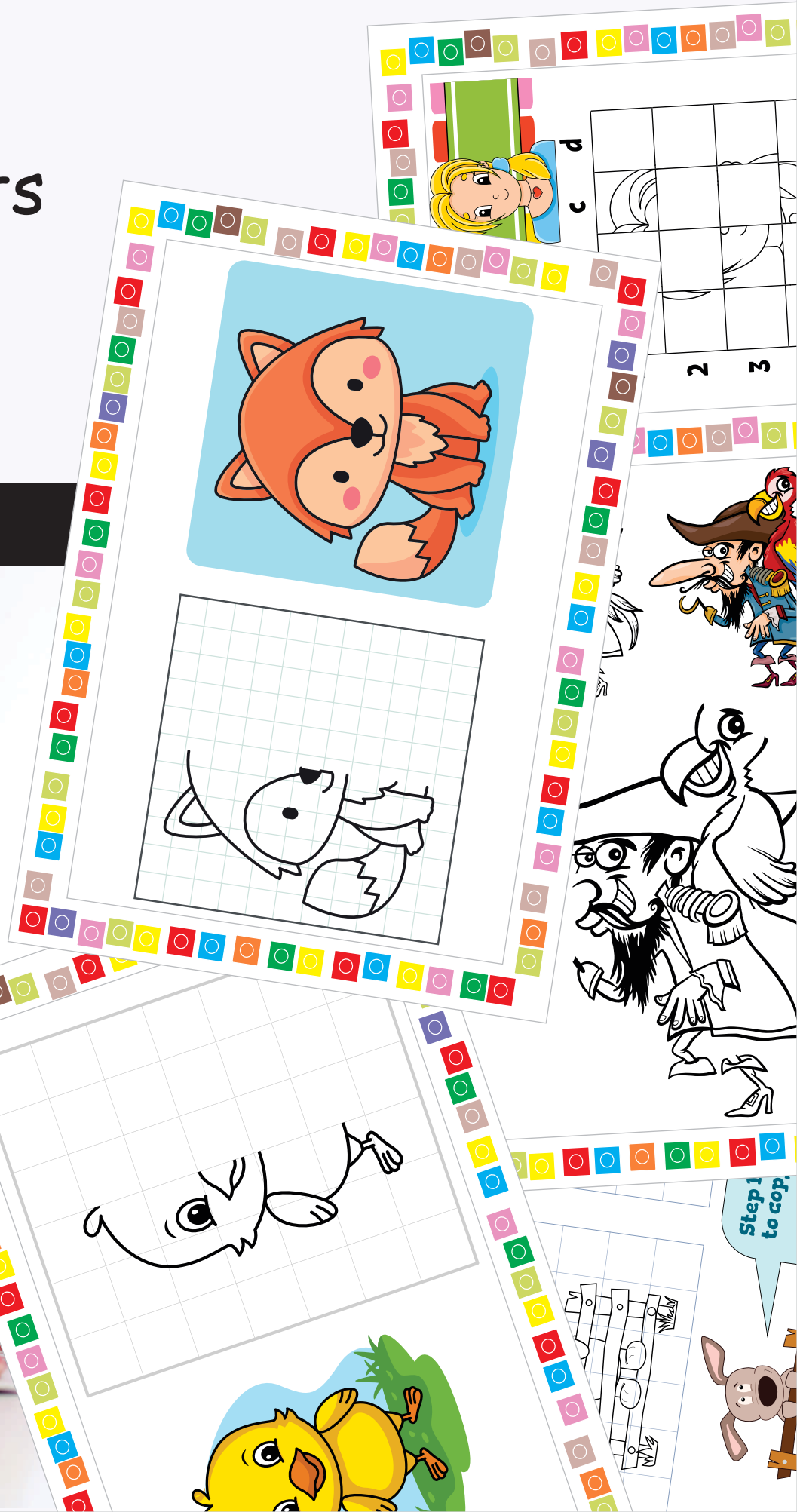

DRAWING

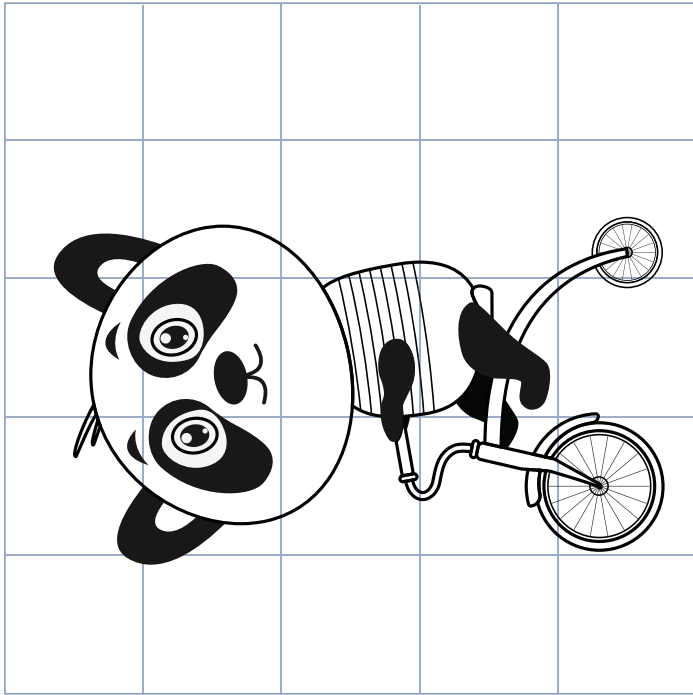
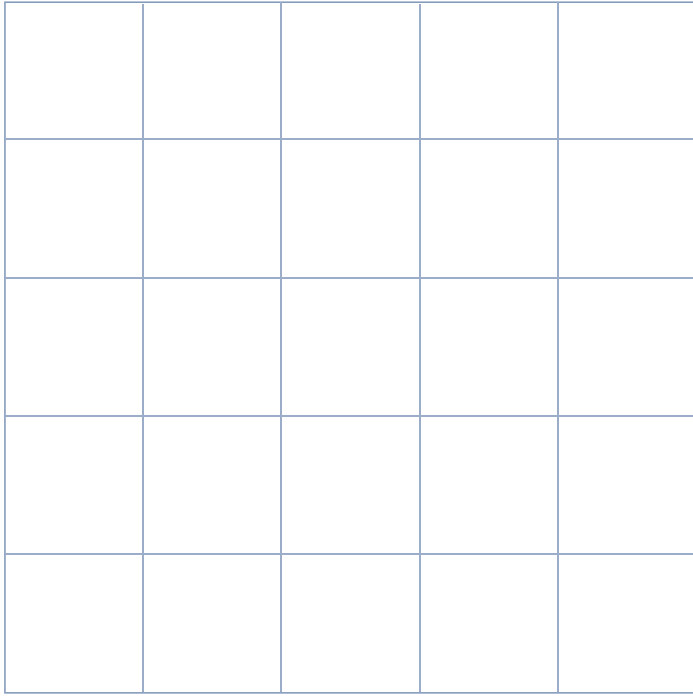

**Step 1: use the grid
to copy the picture**

**Step 2: color your
drawing**



DRAWING

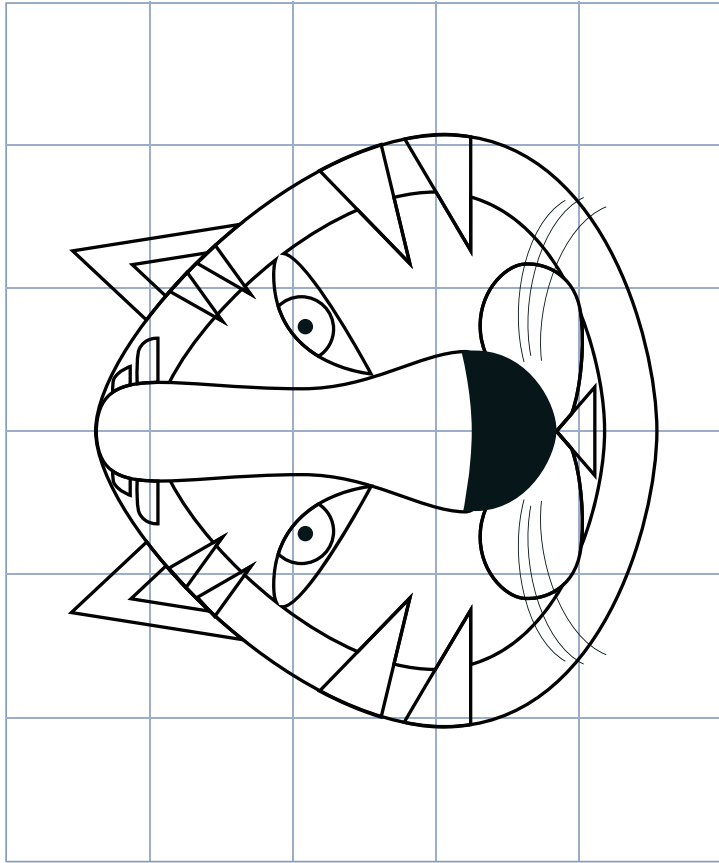
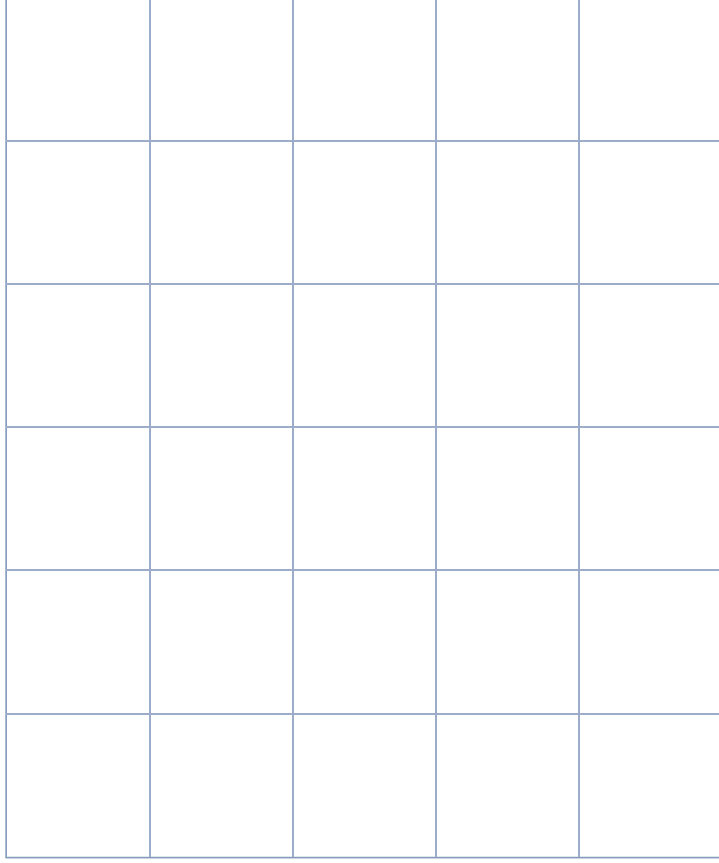

Step 1: use the grid to copy the picture

Step 2: color your drawing



DRAWING

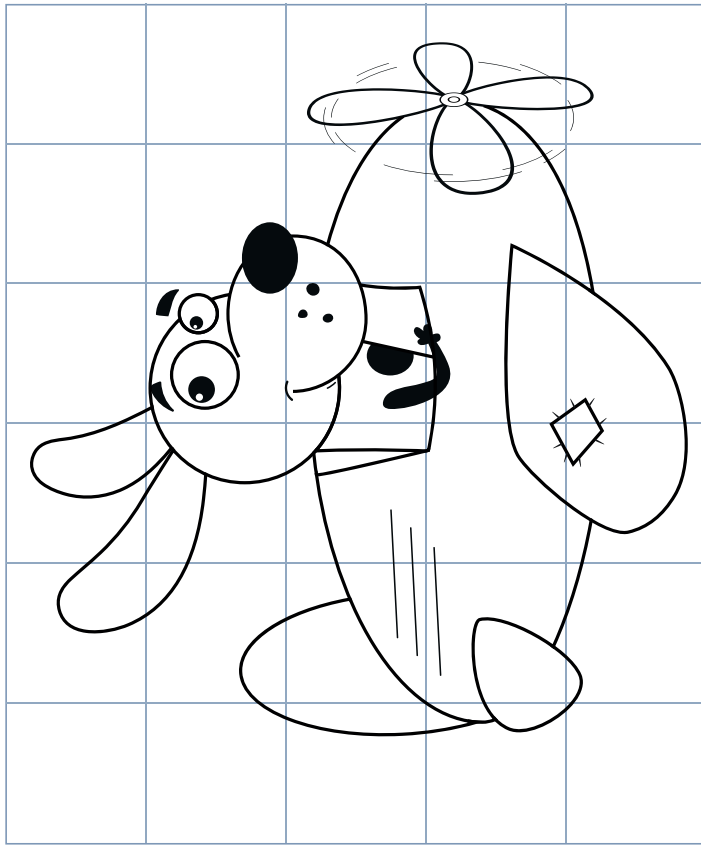
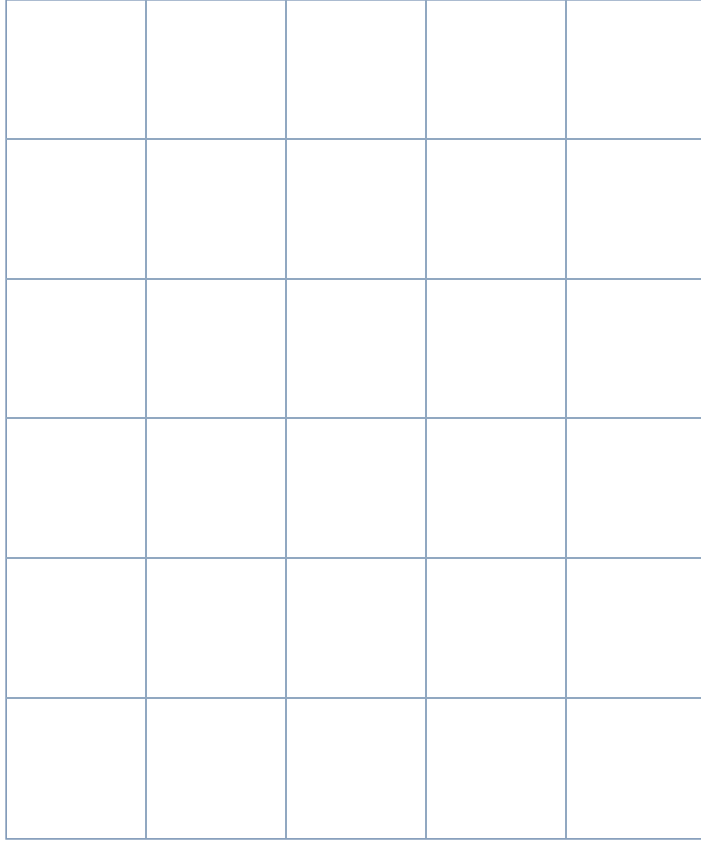

**Step 1: use the grid
to copy the picture**

**Step 2: color your
drawing**



DRAWING

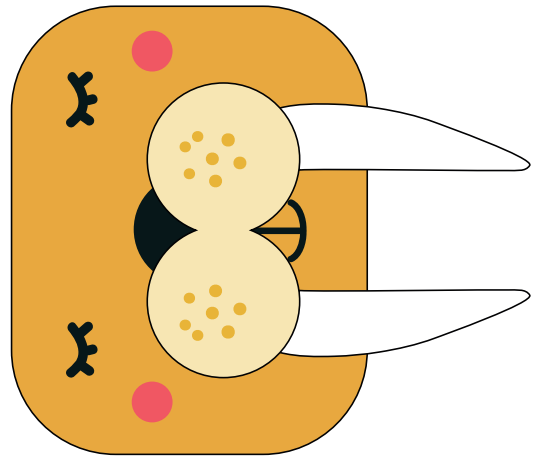
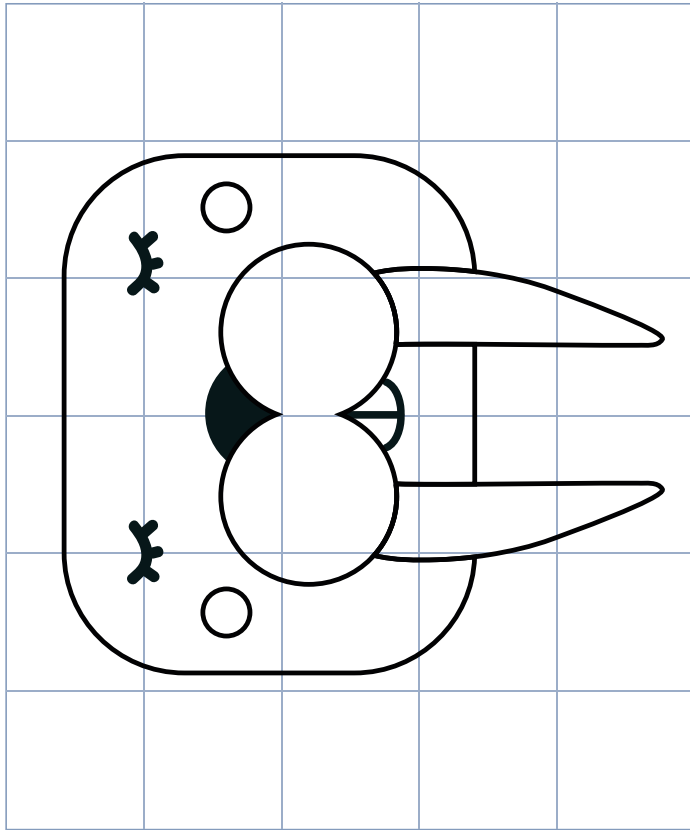
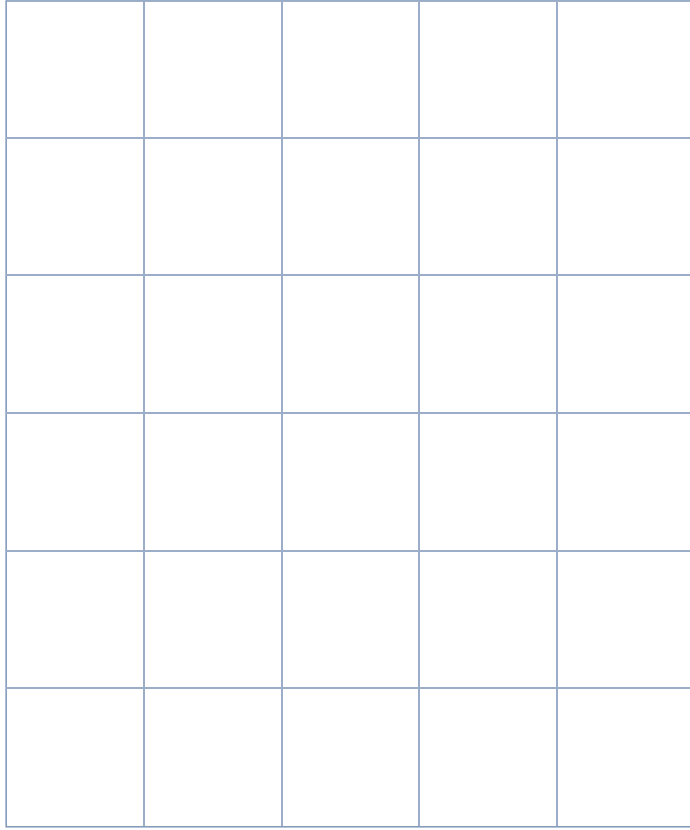

**Step 1: use the grid
to copy the picture**

**Step 2: color your
drawing**

DRAWING

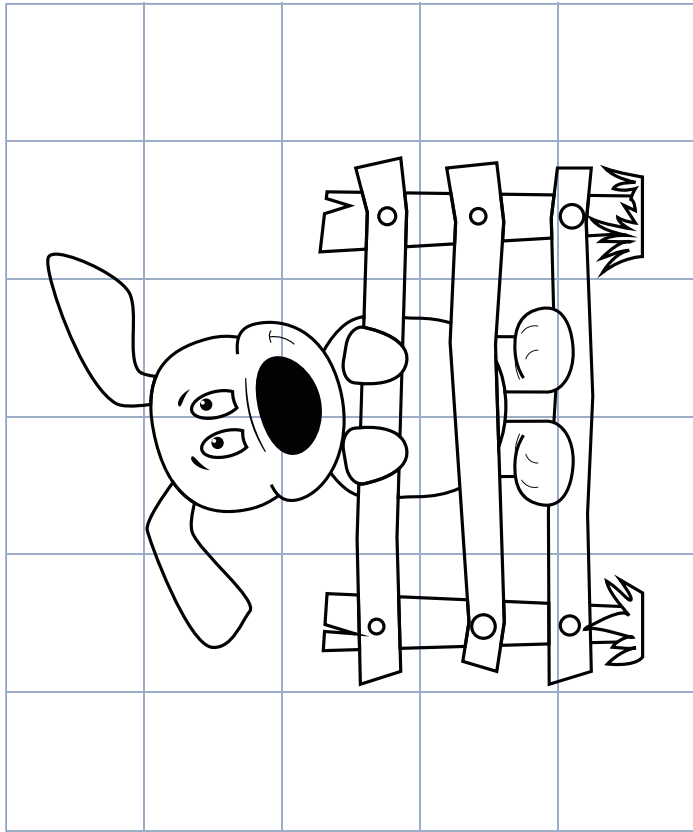
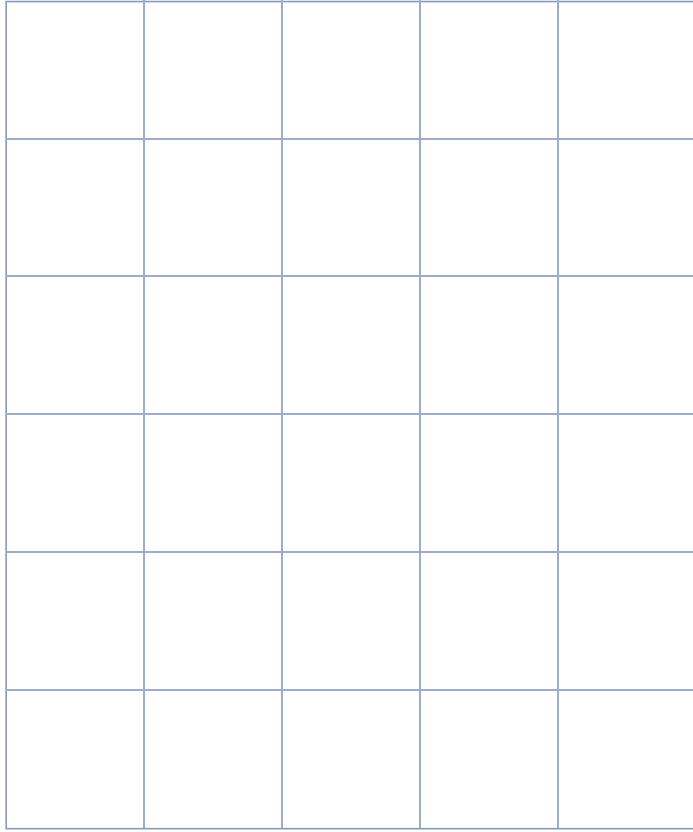

**Step 1: use the grid
to copy the picture**

**Step 2: color your
drawing**

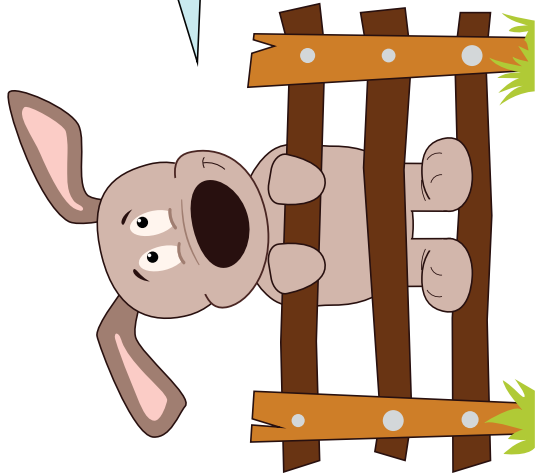

DRAWING

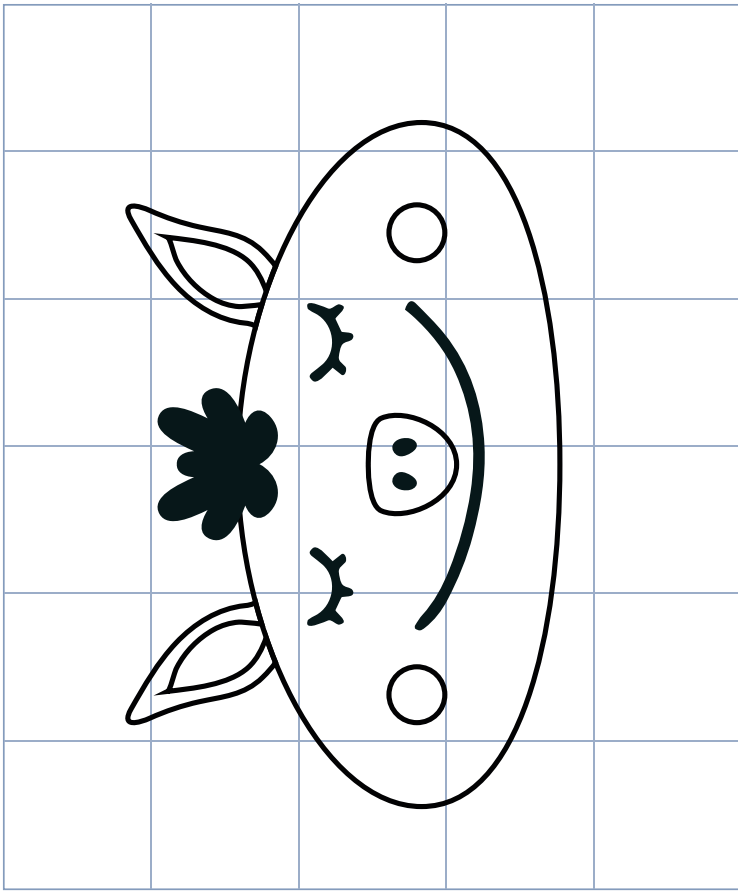
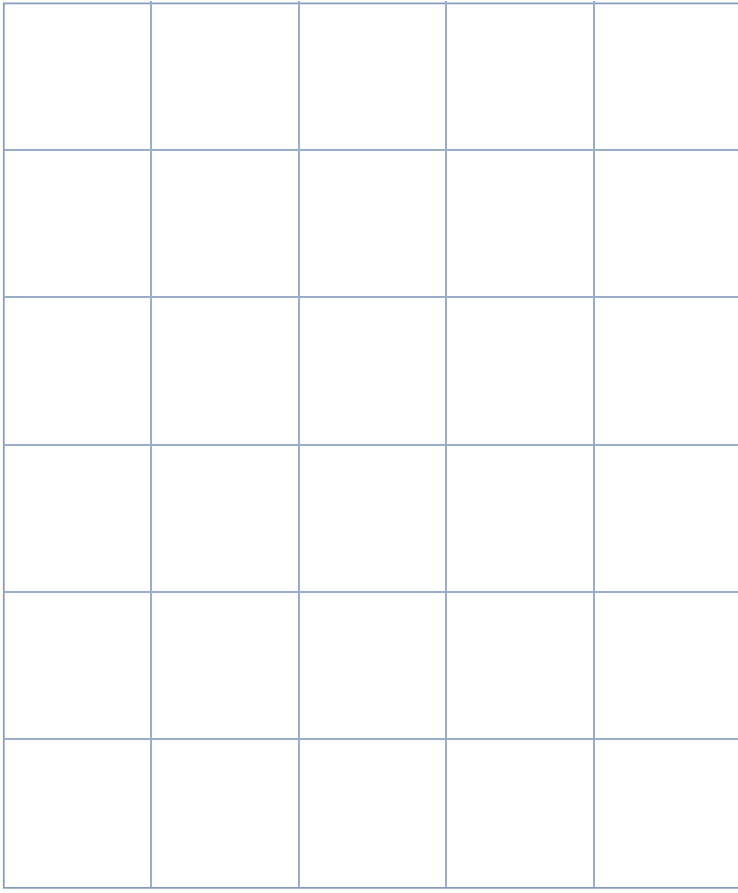

**Step 1: use the grid
to copy the picture**

**Step 2: color your
drawing**

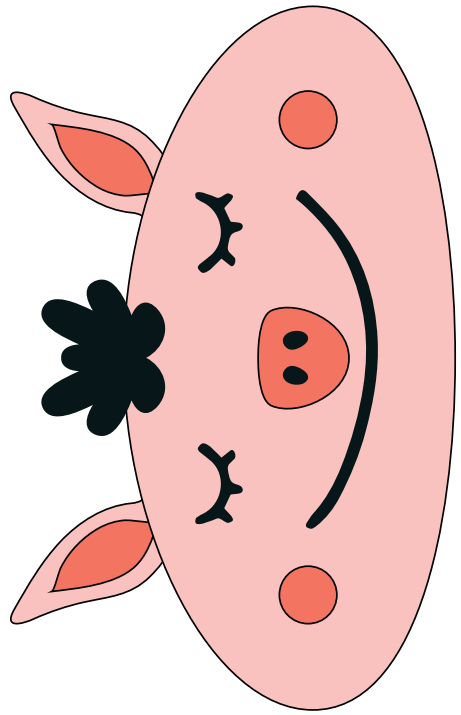

DRAWING

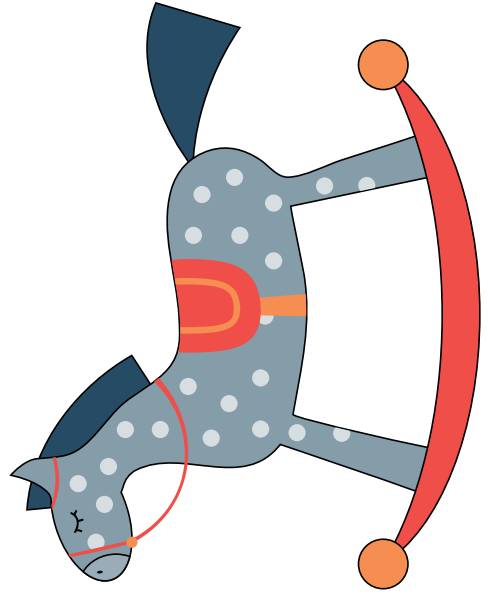
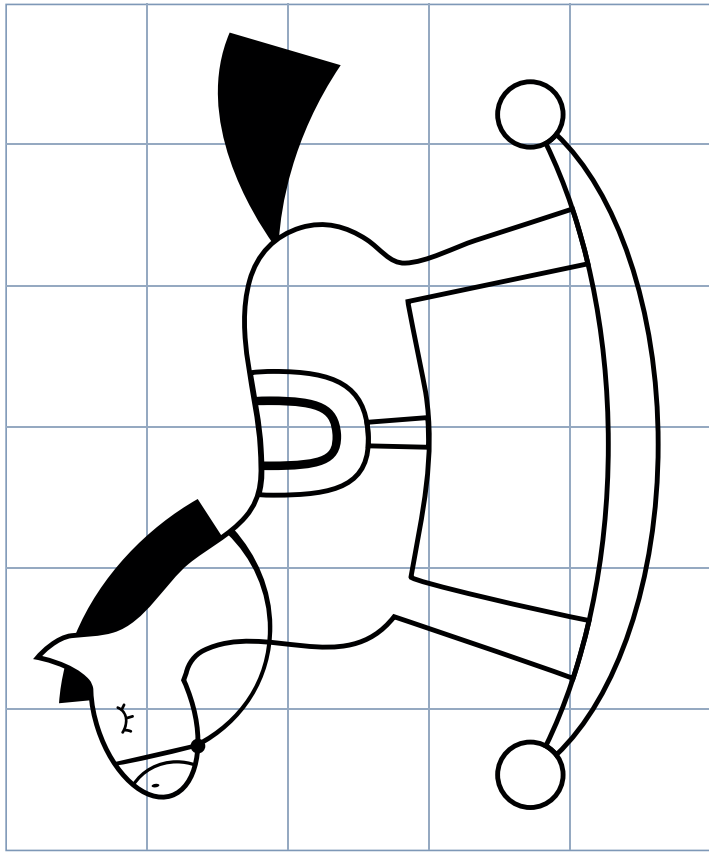
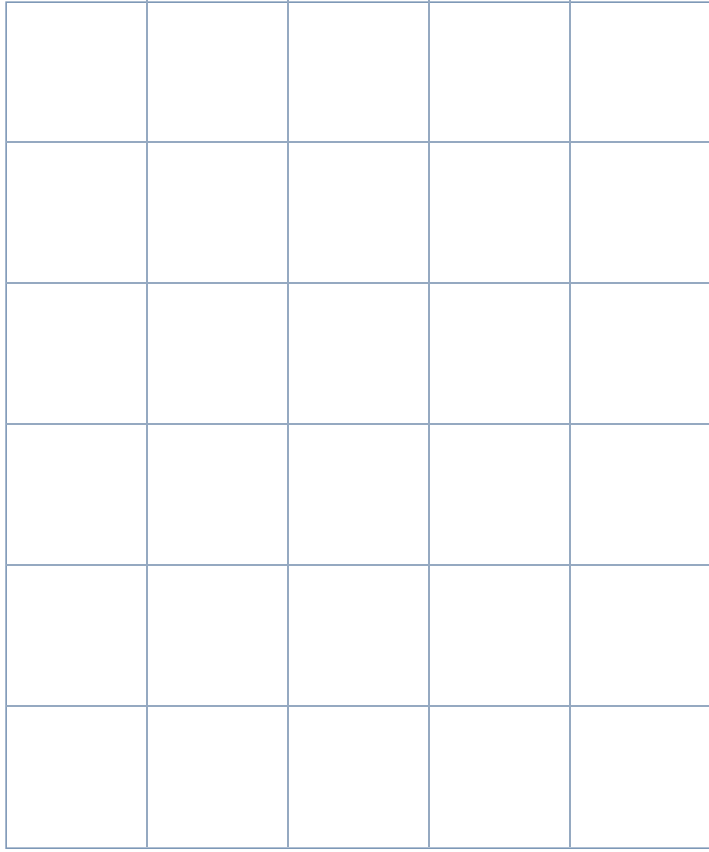

**Step 1: use the grid
to copy the picture**

**Step 2: color your
drawing**

DRAWING

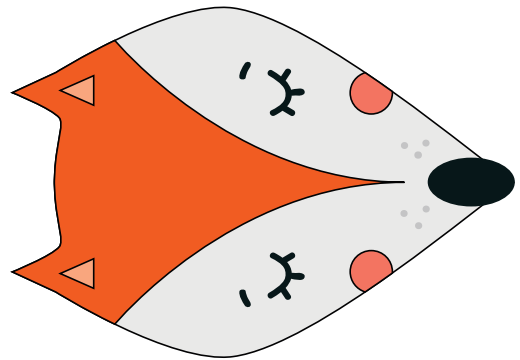
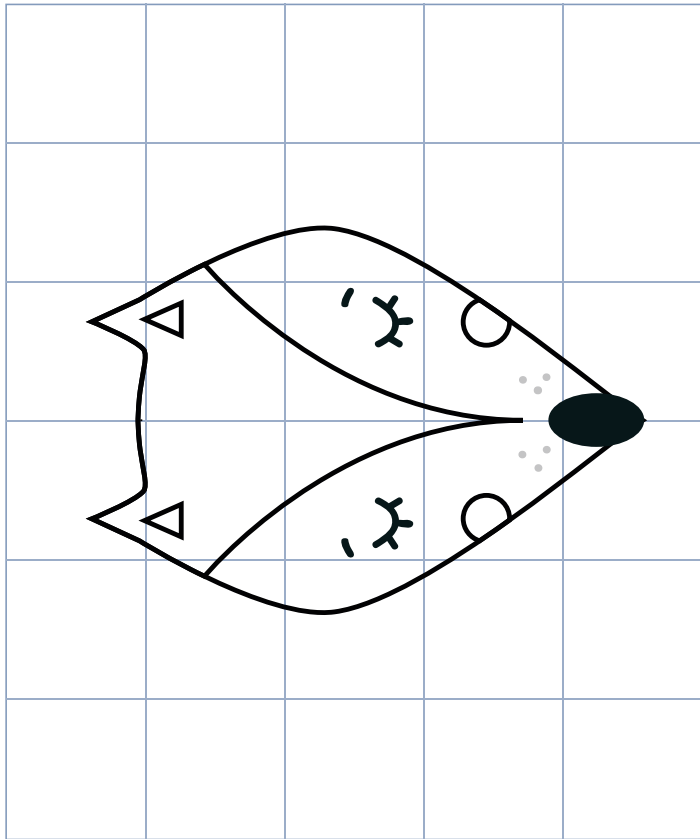
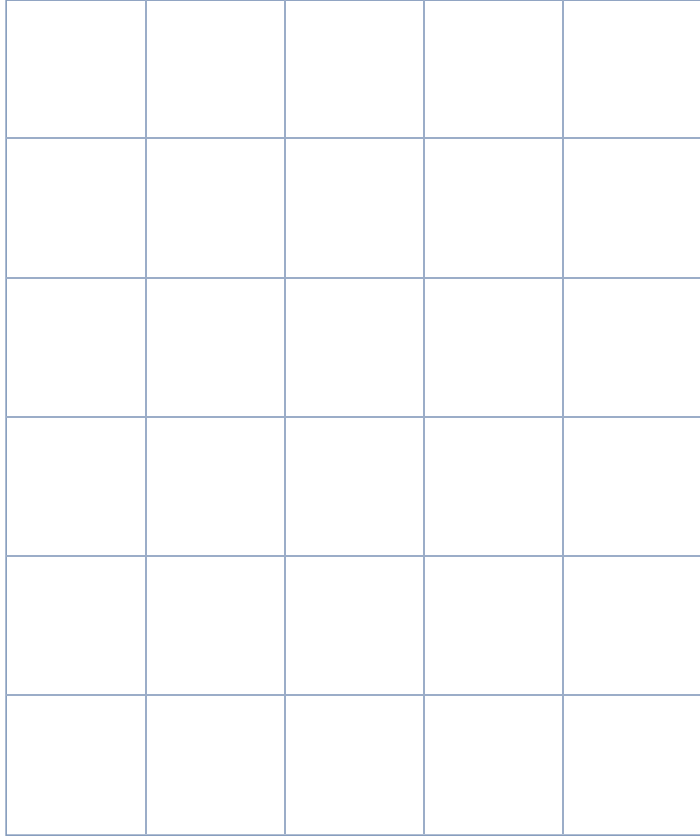

**Step 1: use the grid
to copy the picture**

**Step 2: color your
drawing**

DRAWING

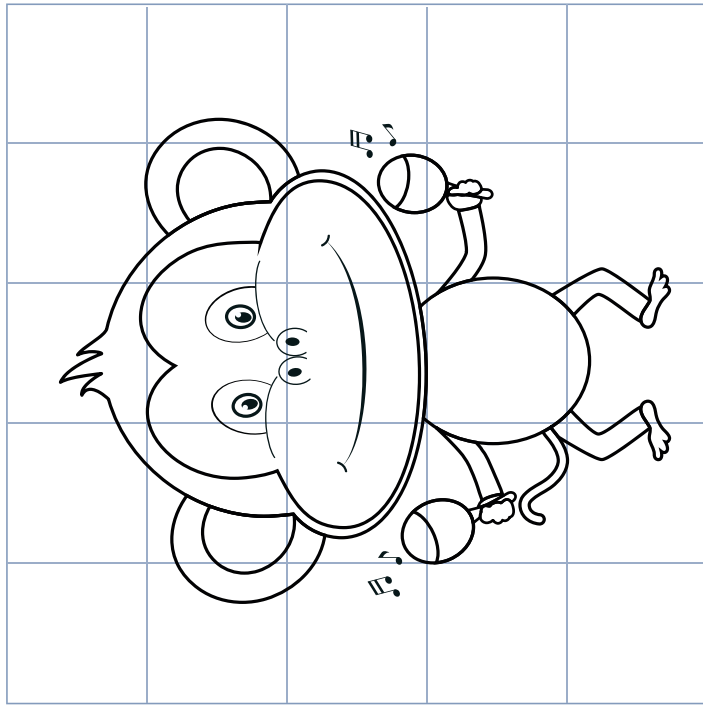
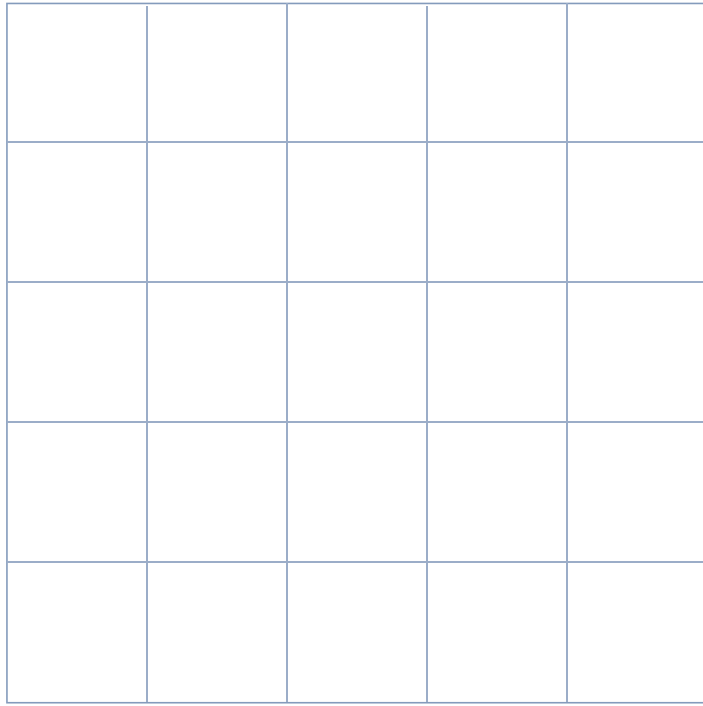

**Step 1: use the grid
to copy the picture**

**Step 2: color your
drawing**



DRAWING

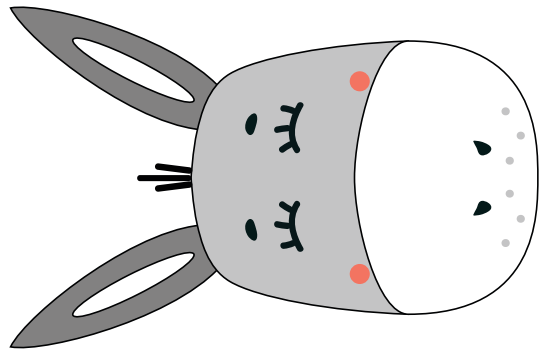
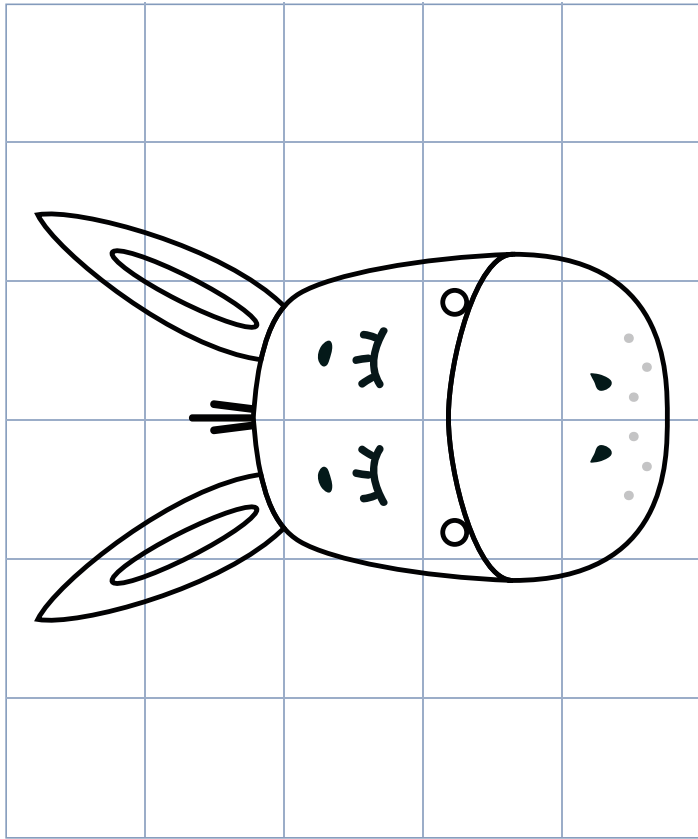
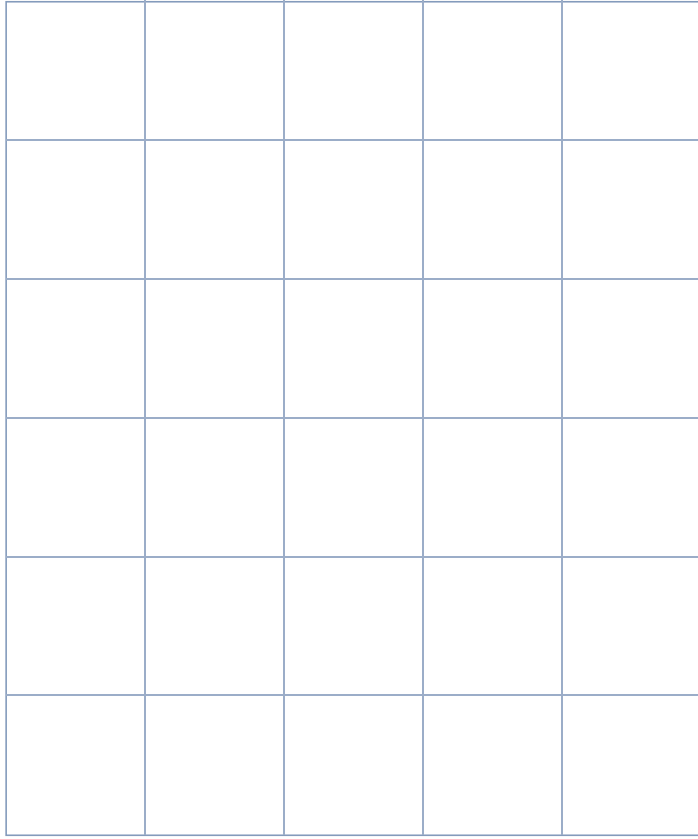

**Step 1: use the grid
to copy the picture**

**Step 2: color your
drawing**

DRAWING

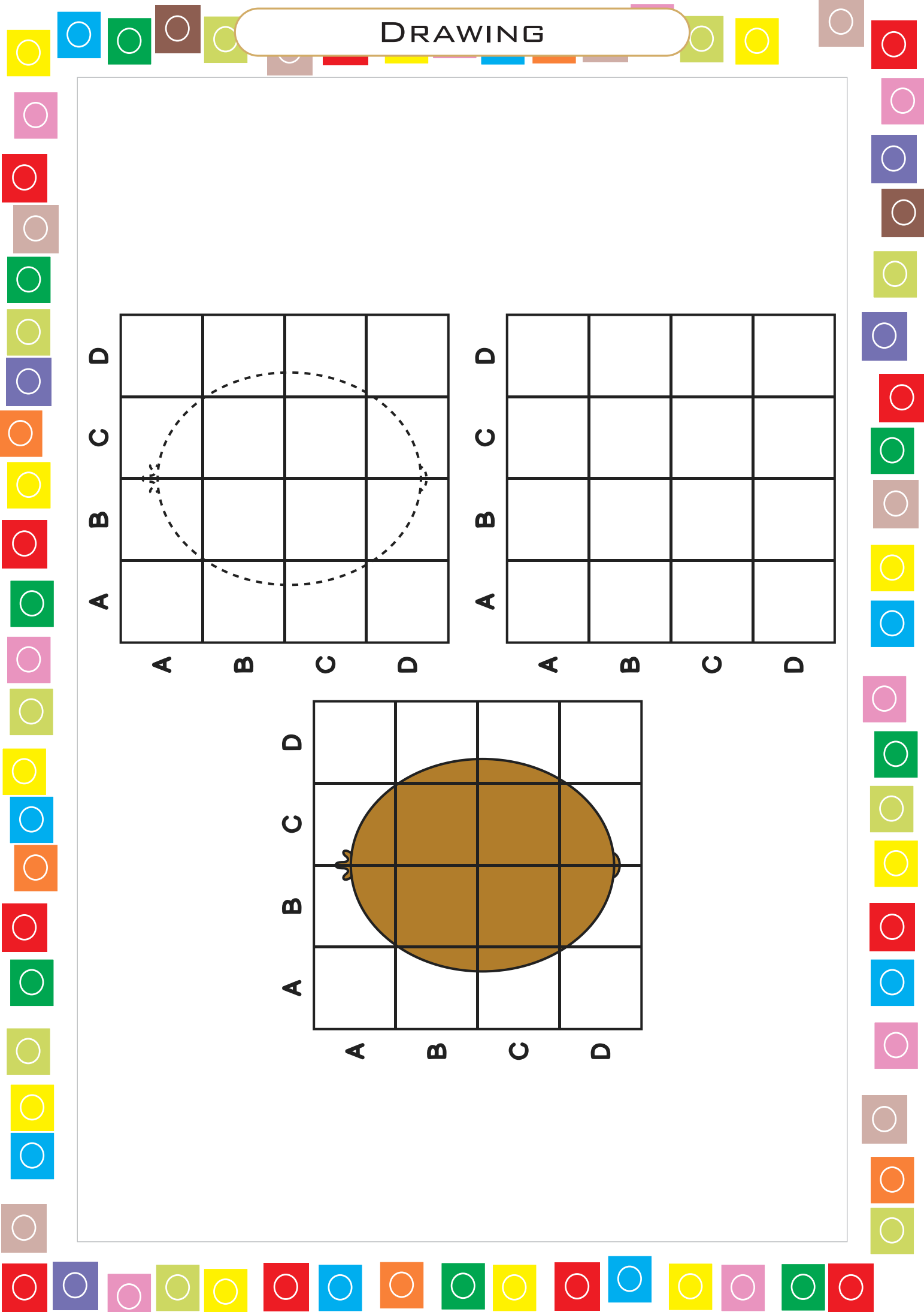
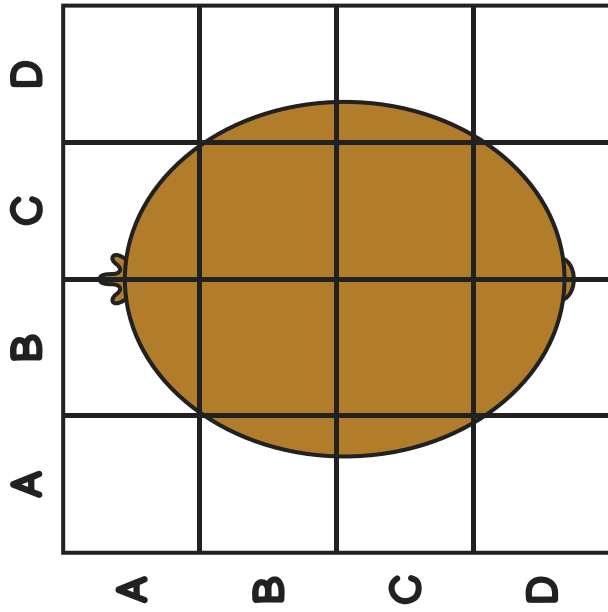
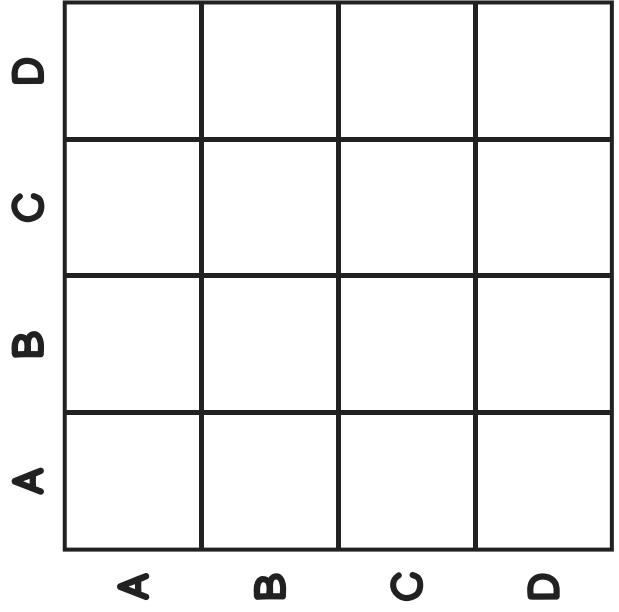
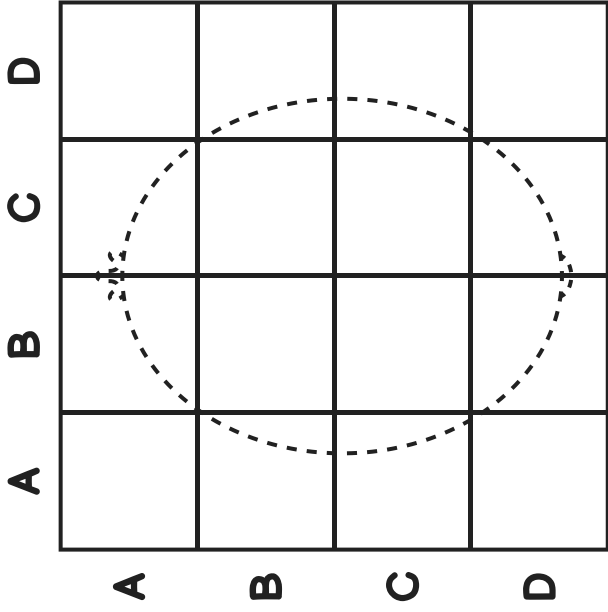

DRAWING

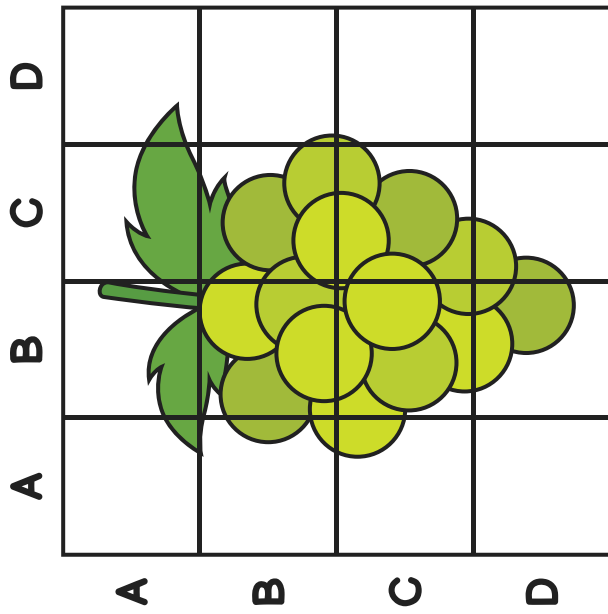
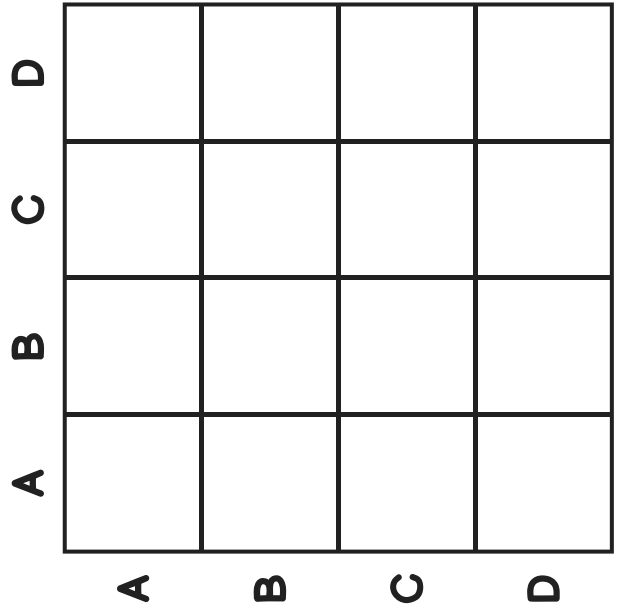
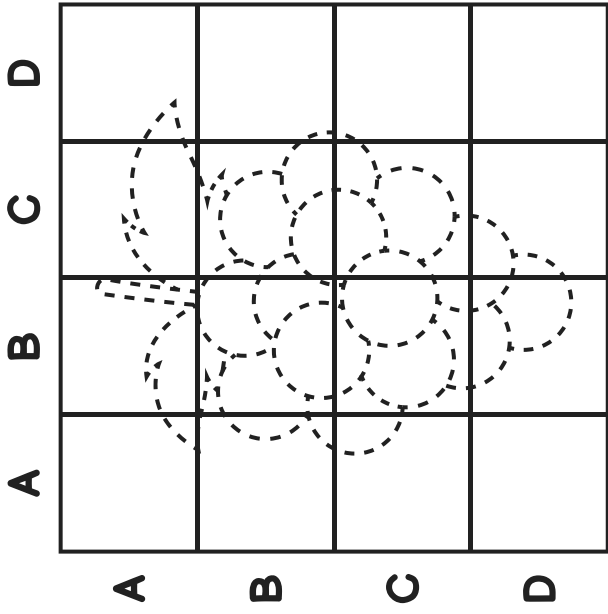

DRAWING

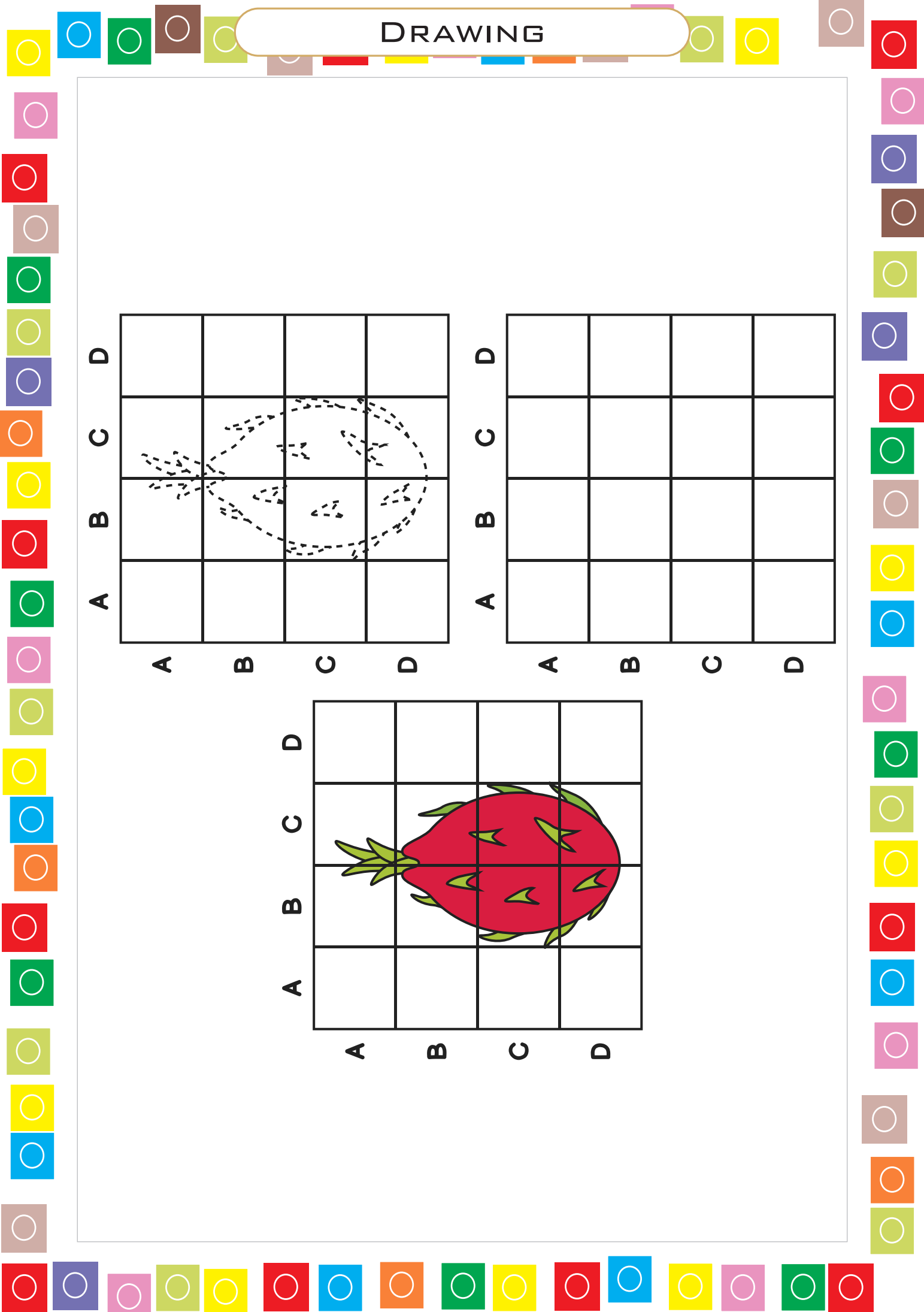
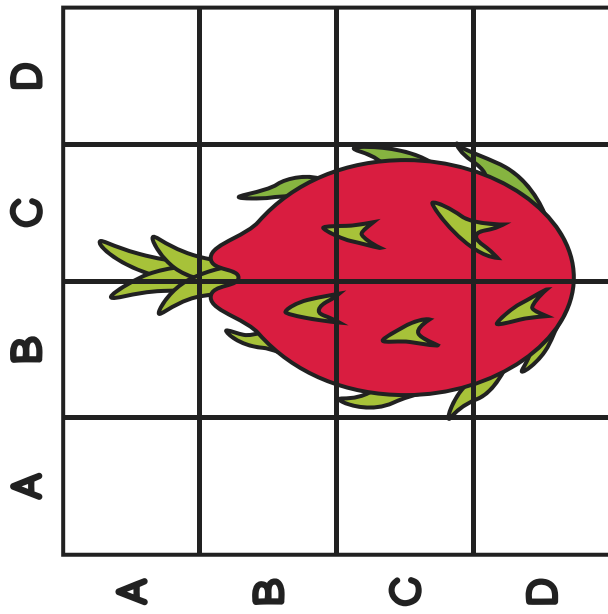
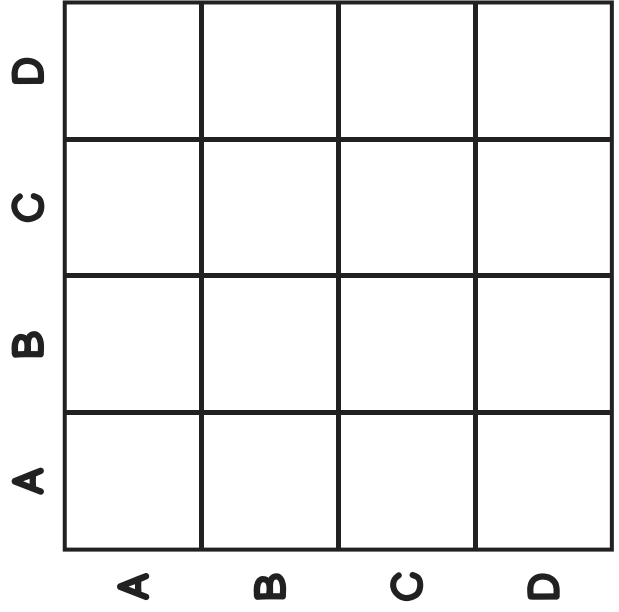
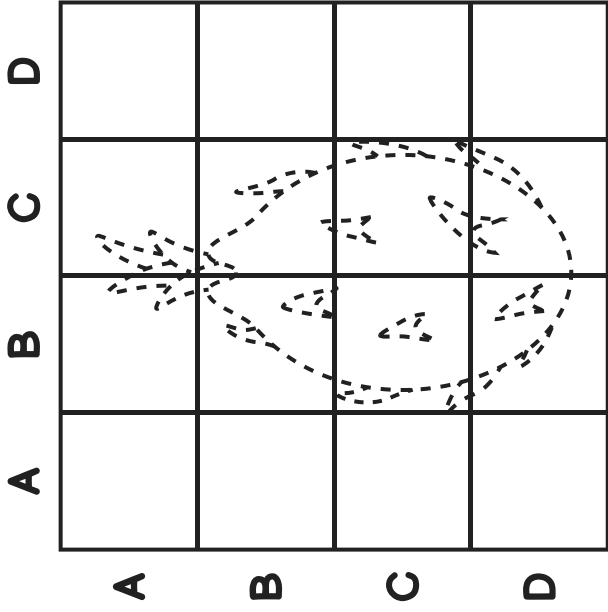

DRAWING

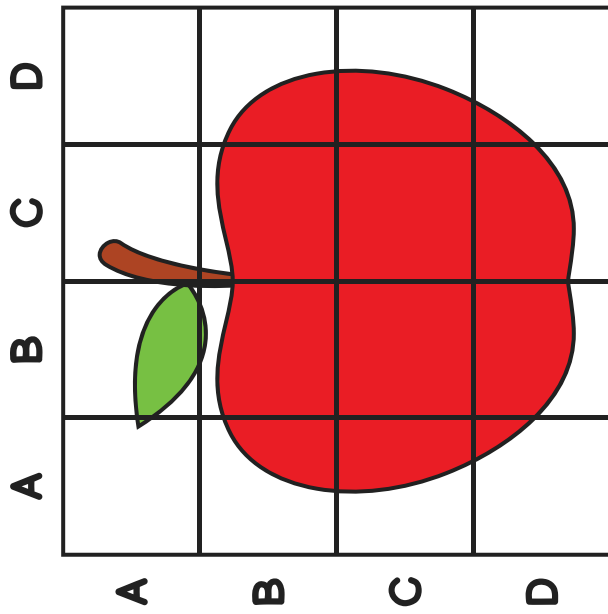
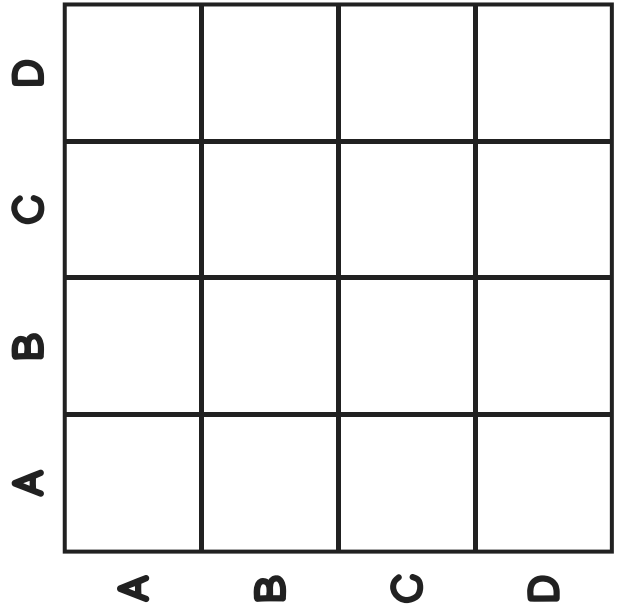
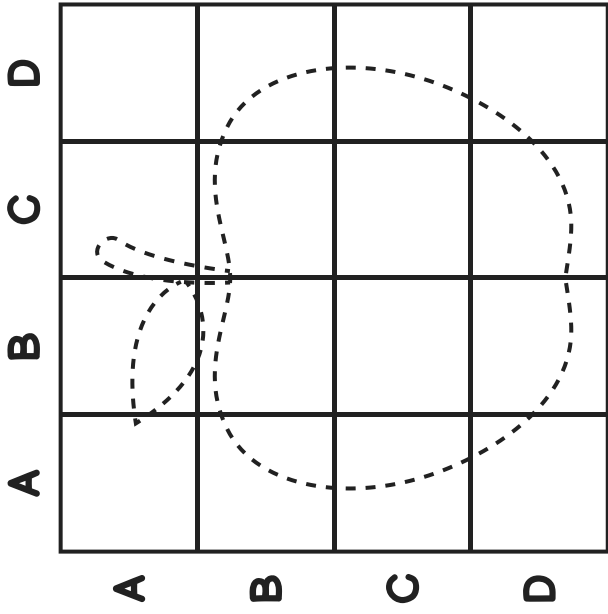

DRAWING

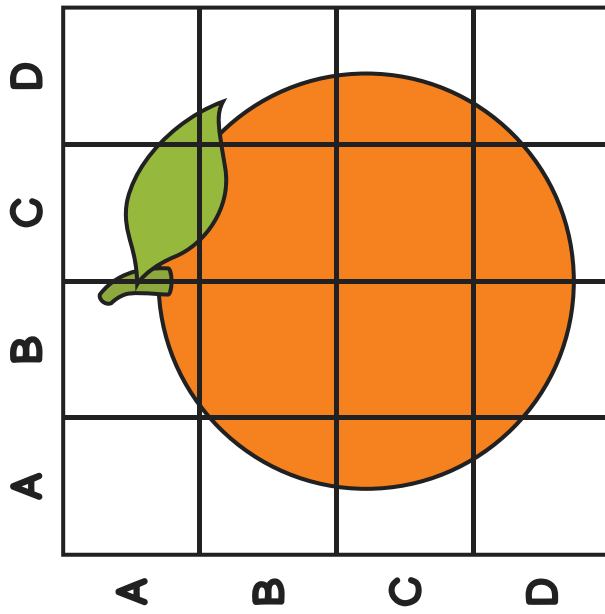
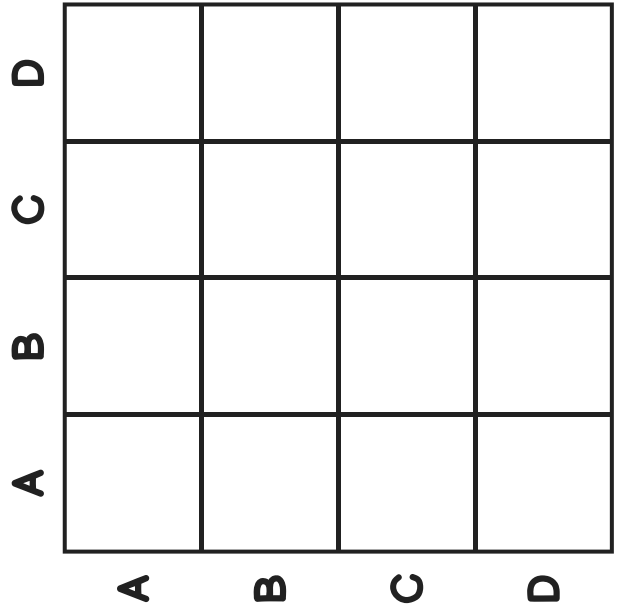
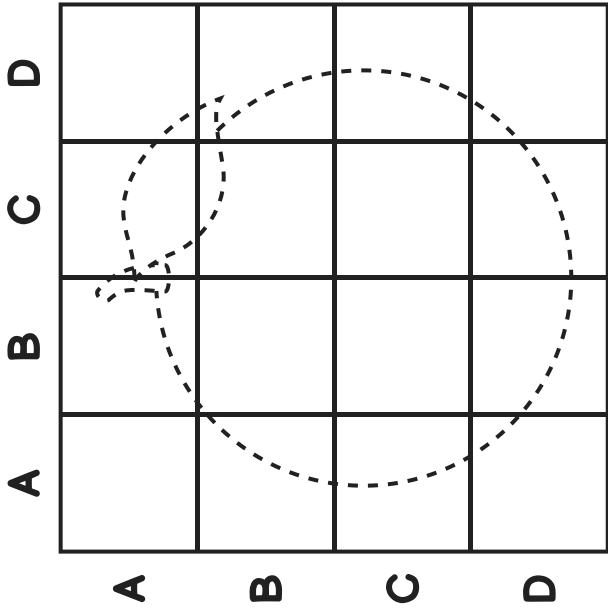

DRAWING

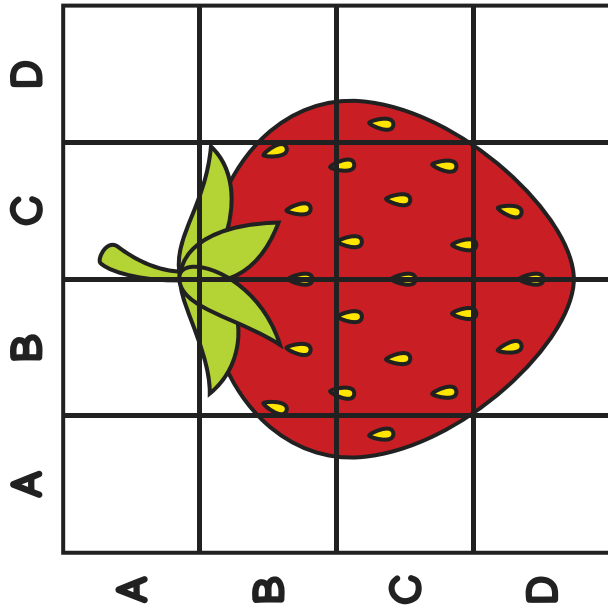
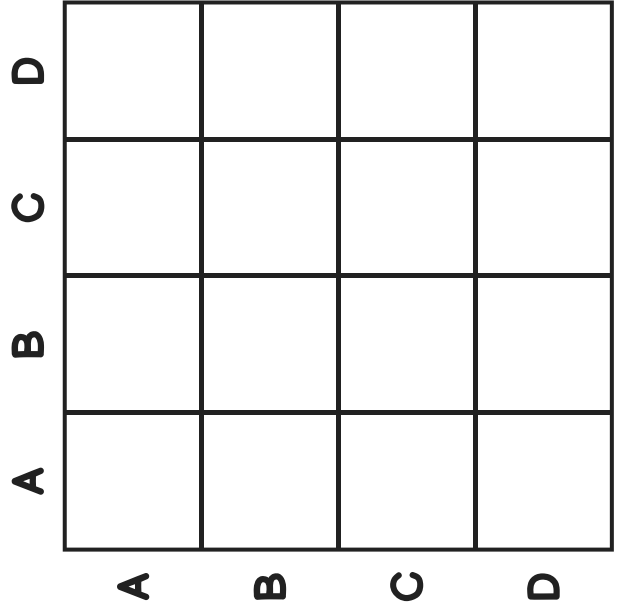
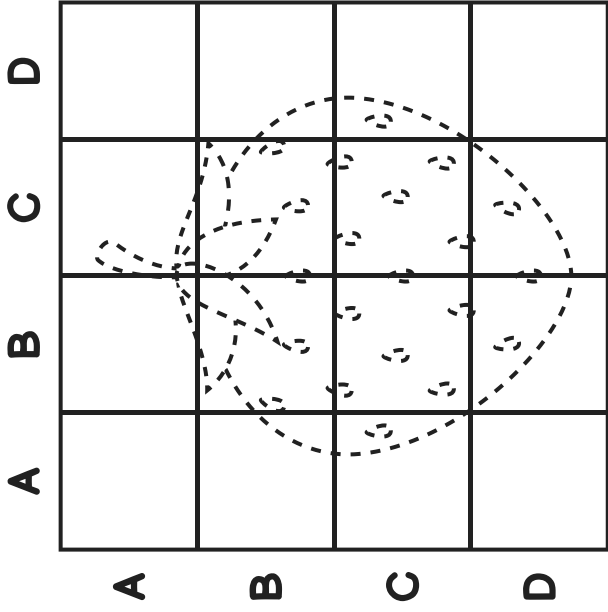

DRAWING

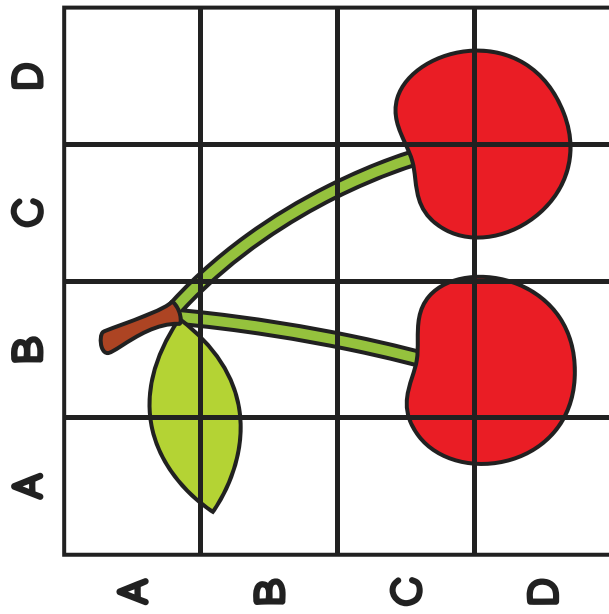
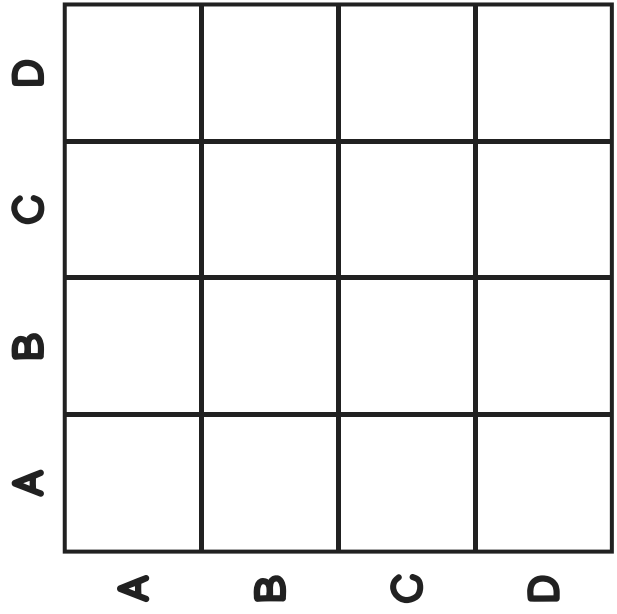
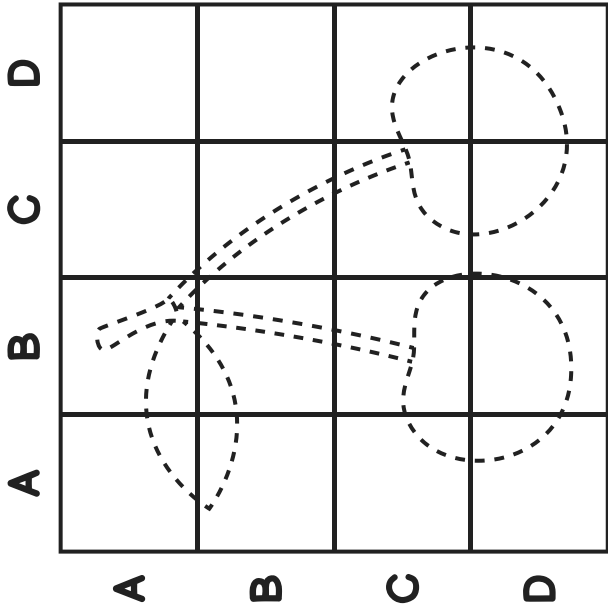

DRAWING

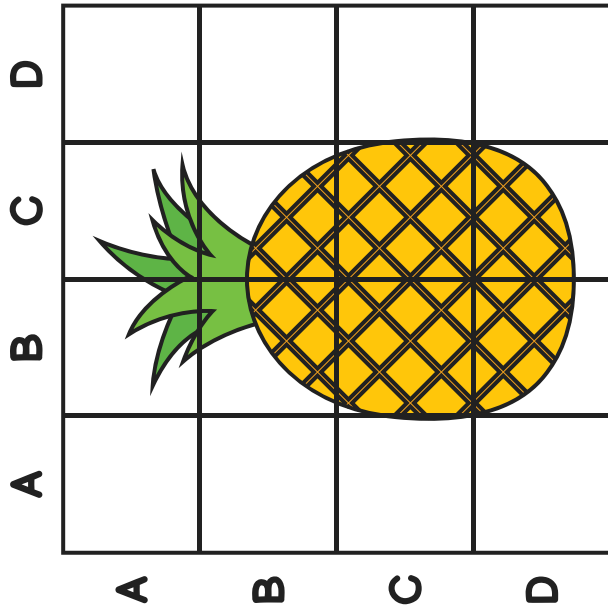
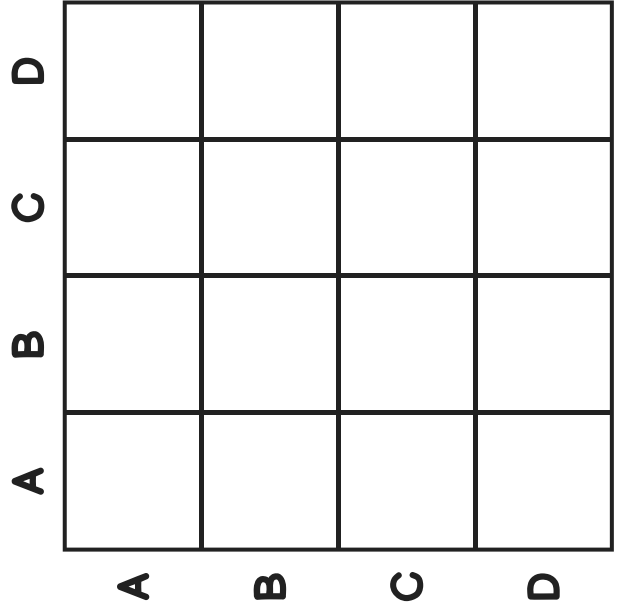
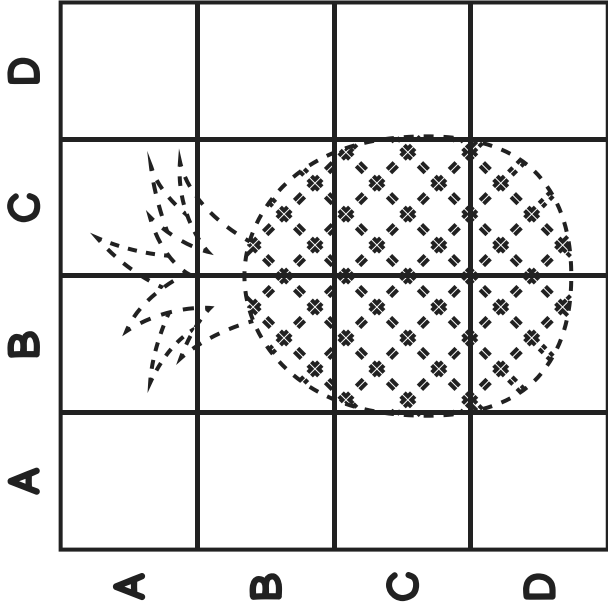

DRAWING

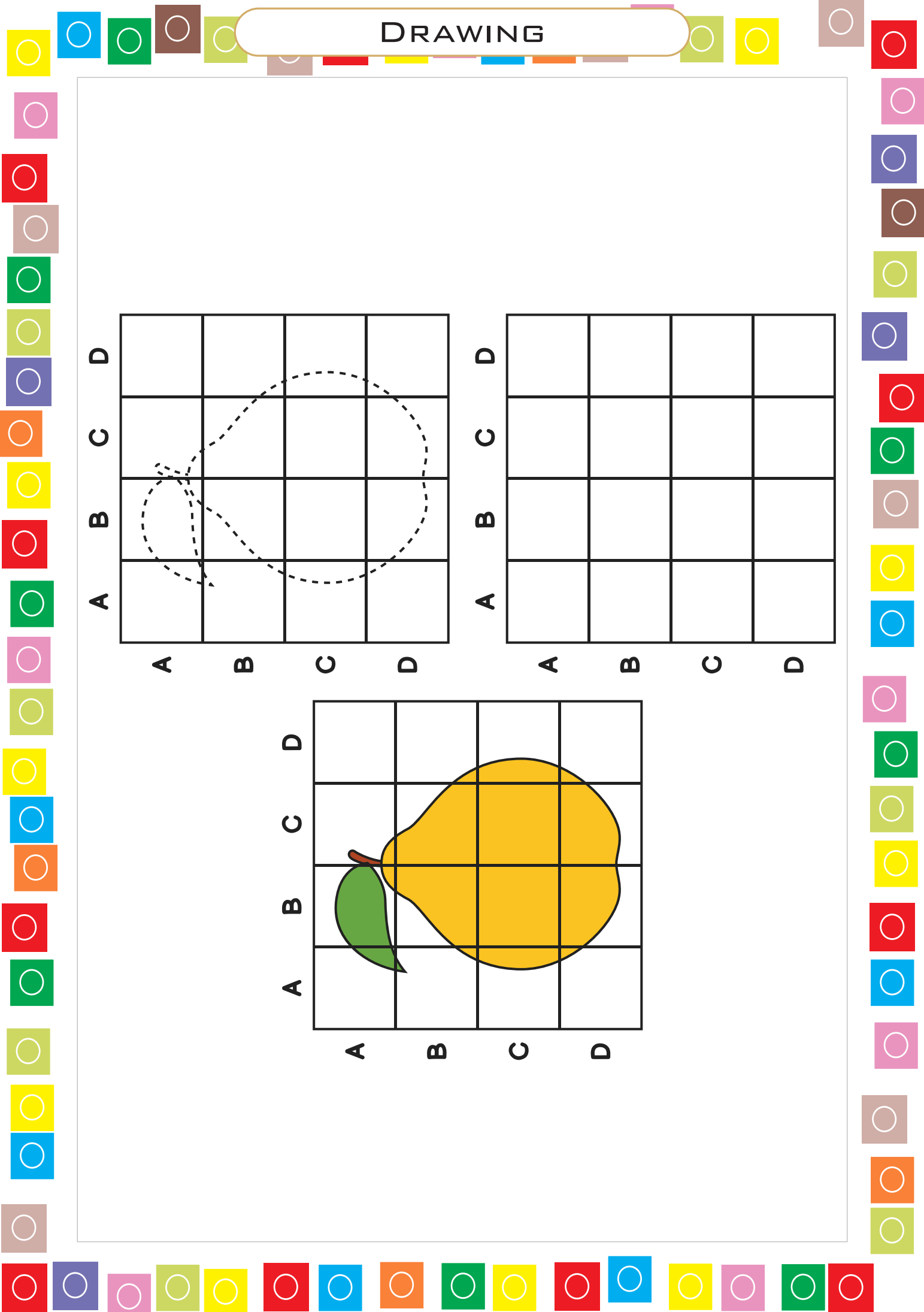
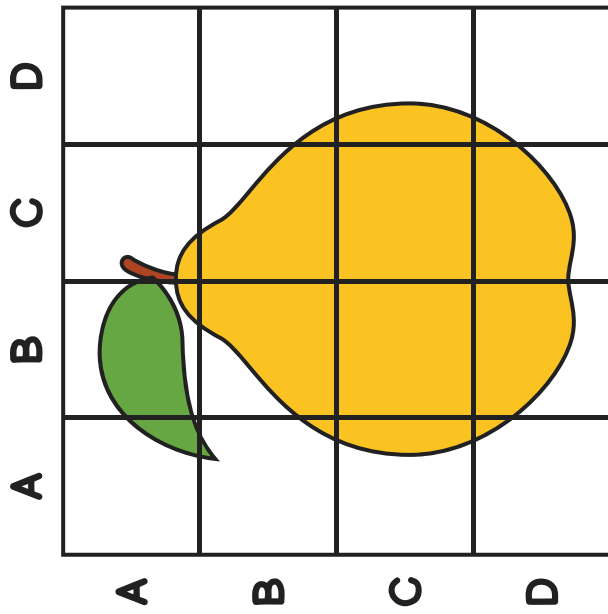
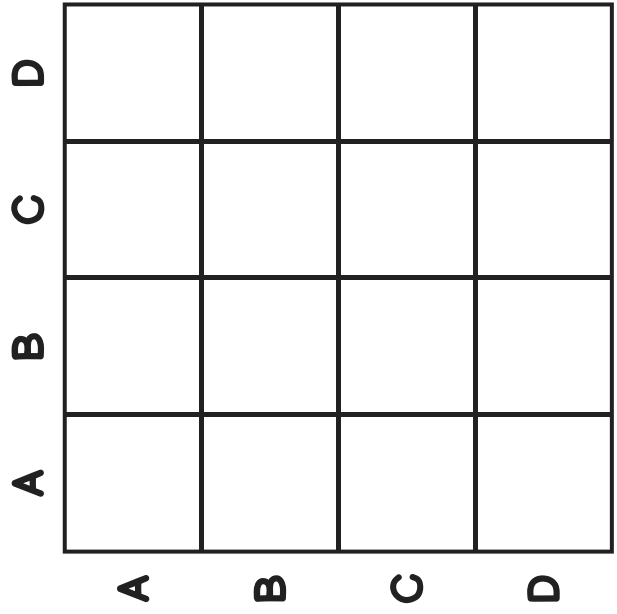
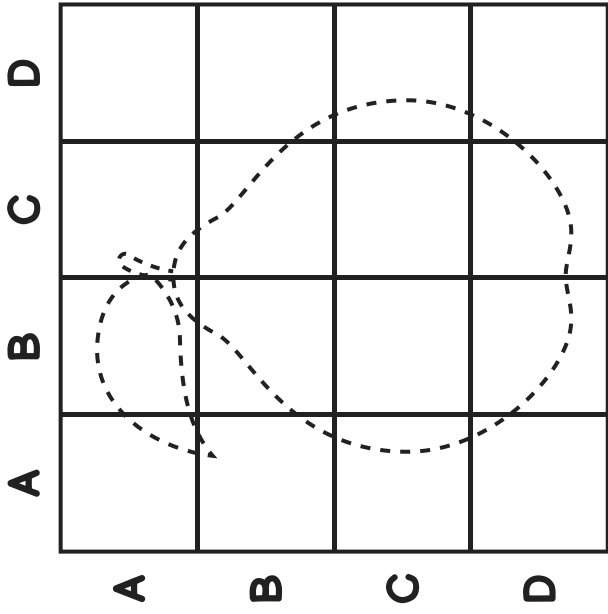

DRAWING

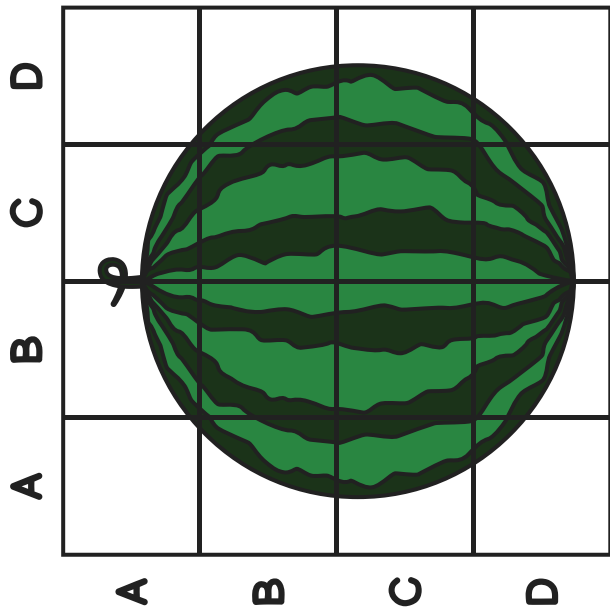
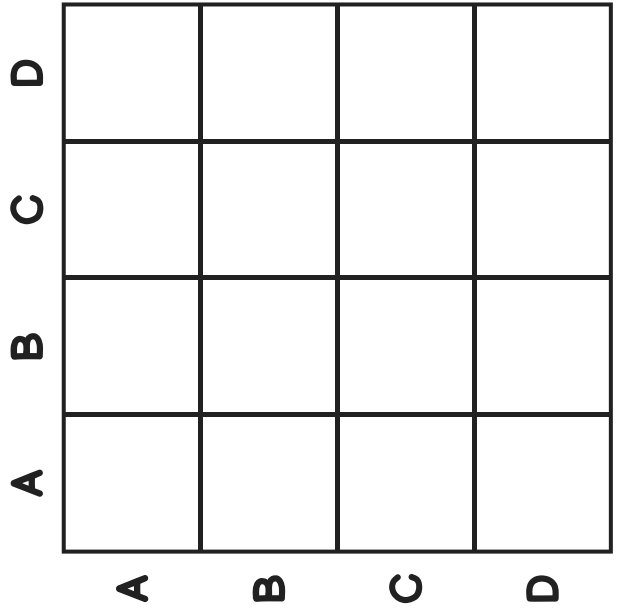
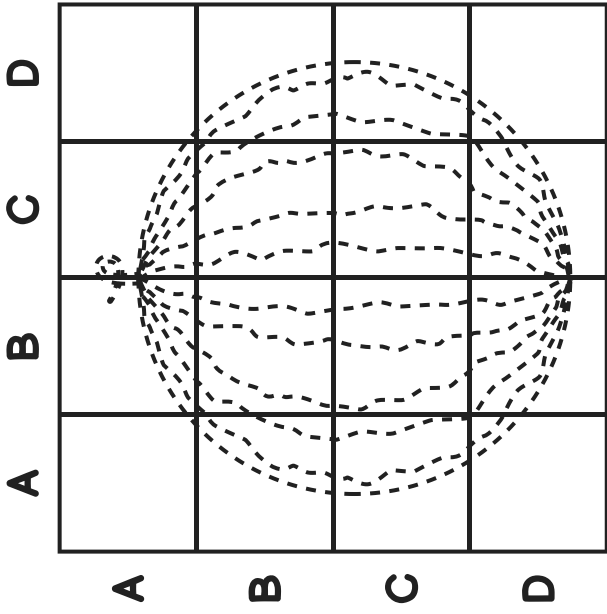

DRAWING

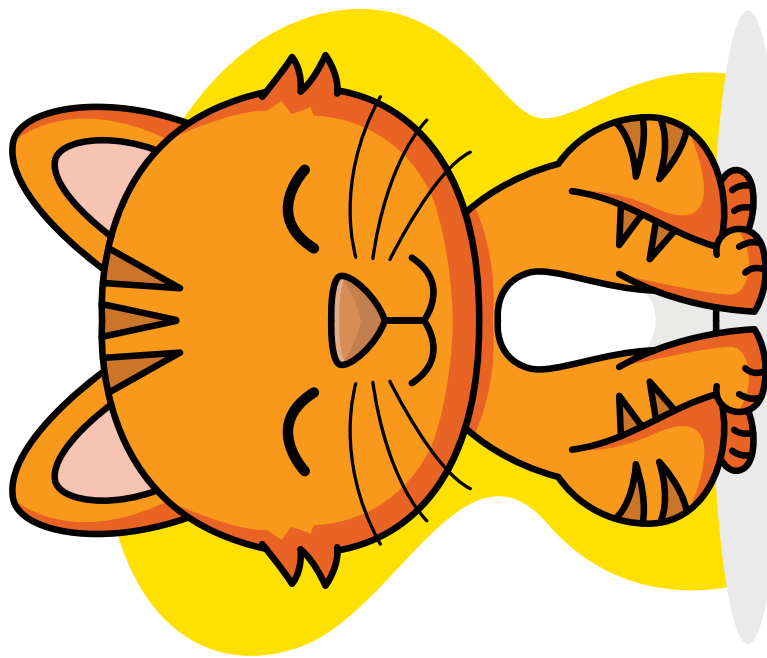
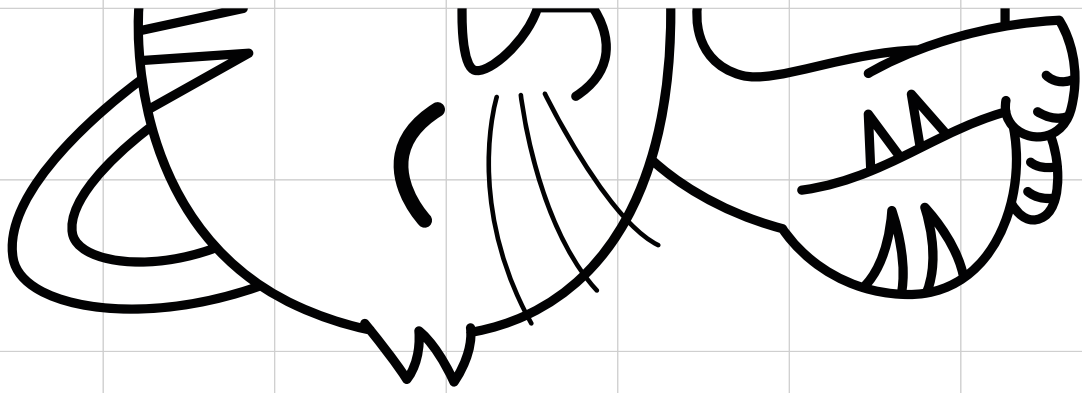

DRAWING



DRAWING

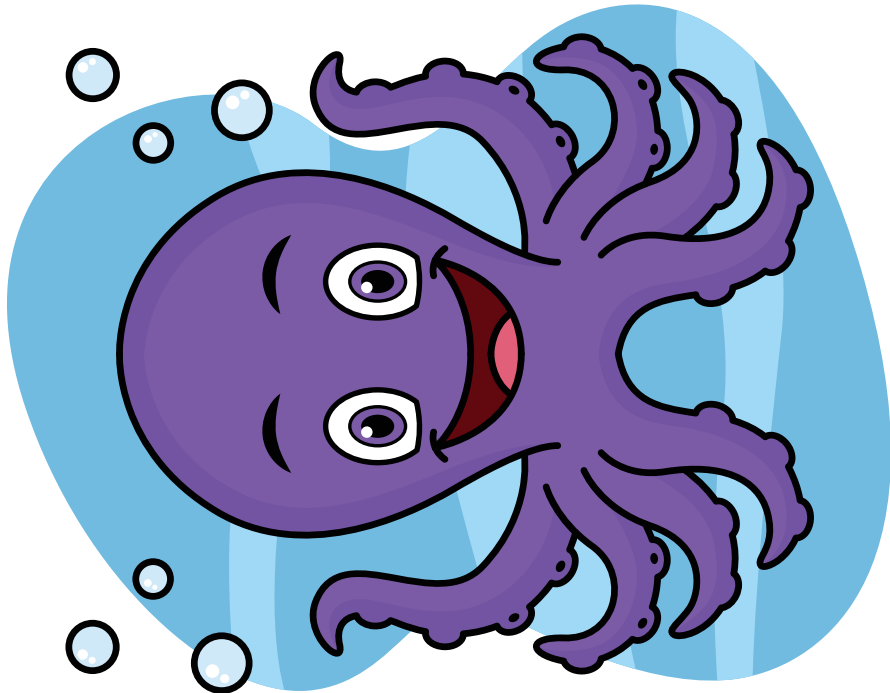
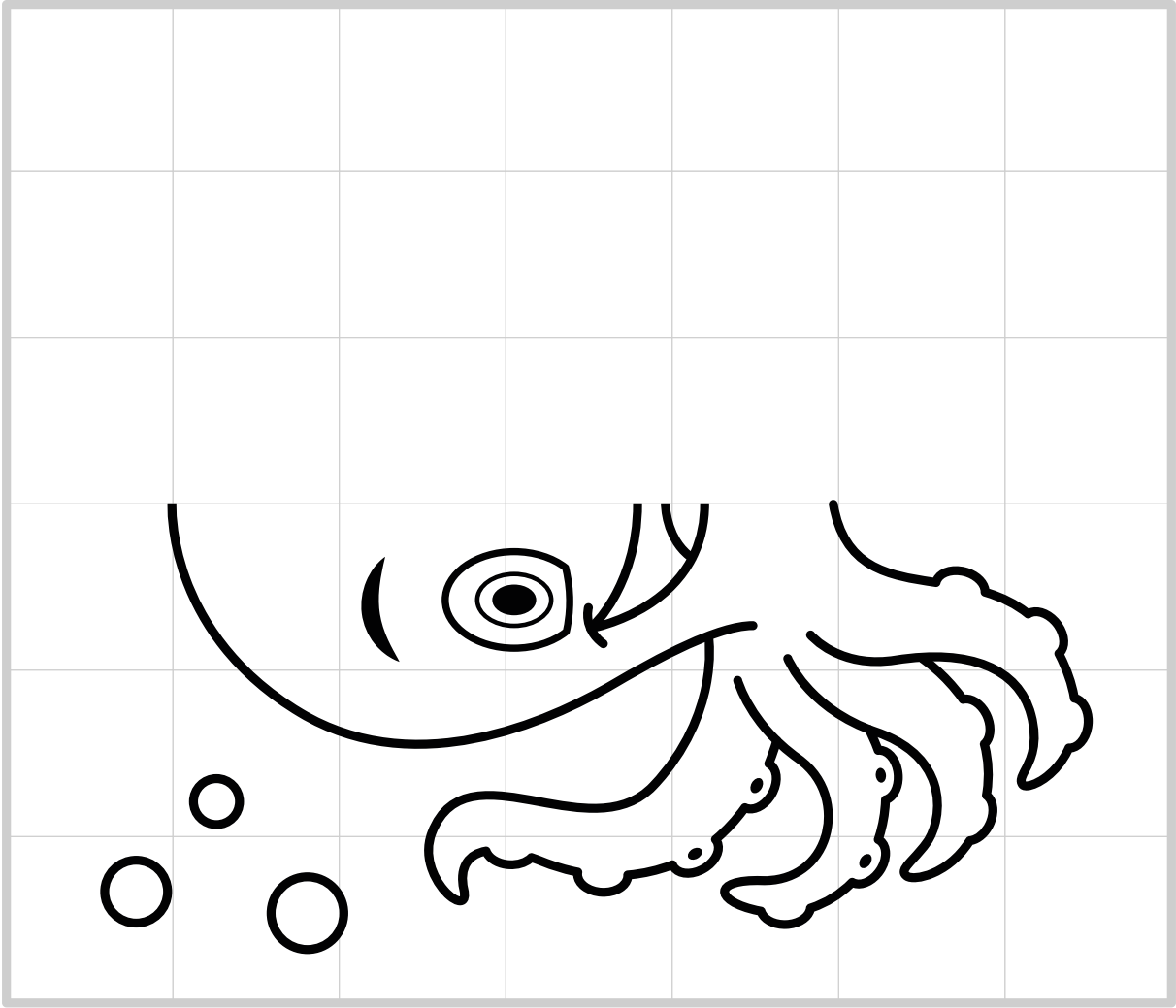

DRAWING

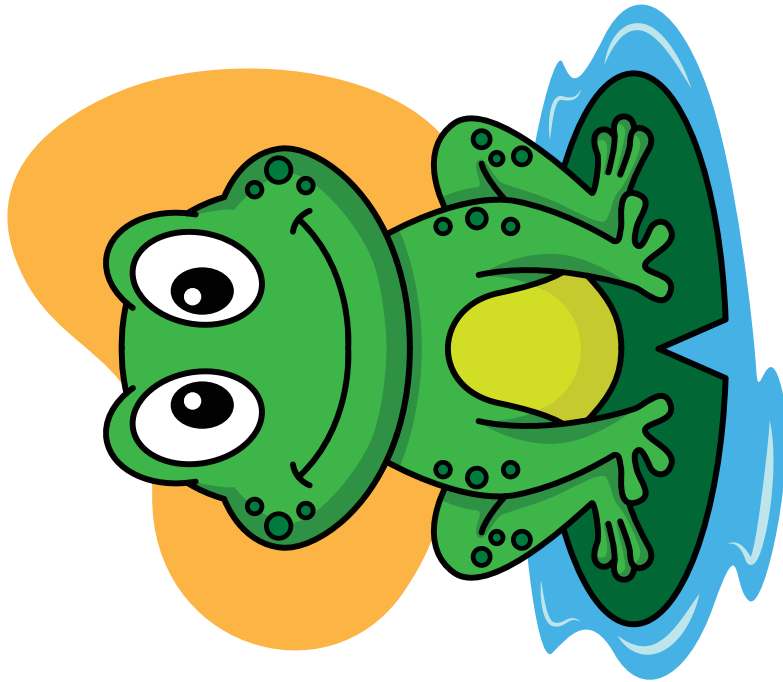
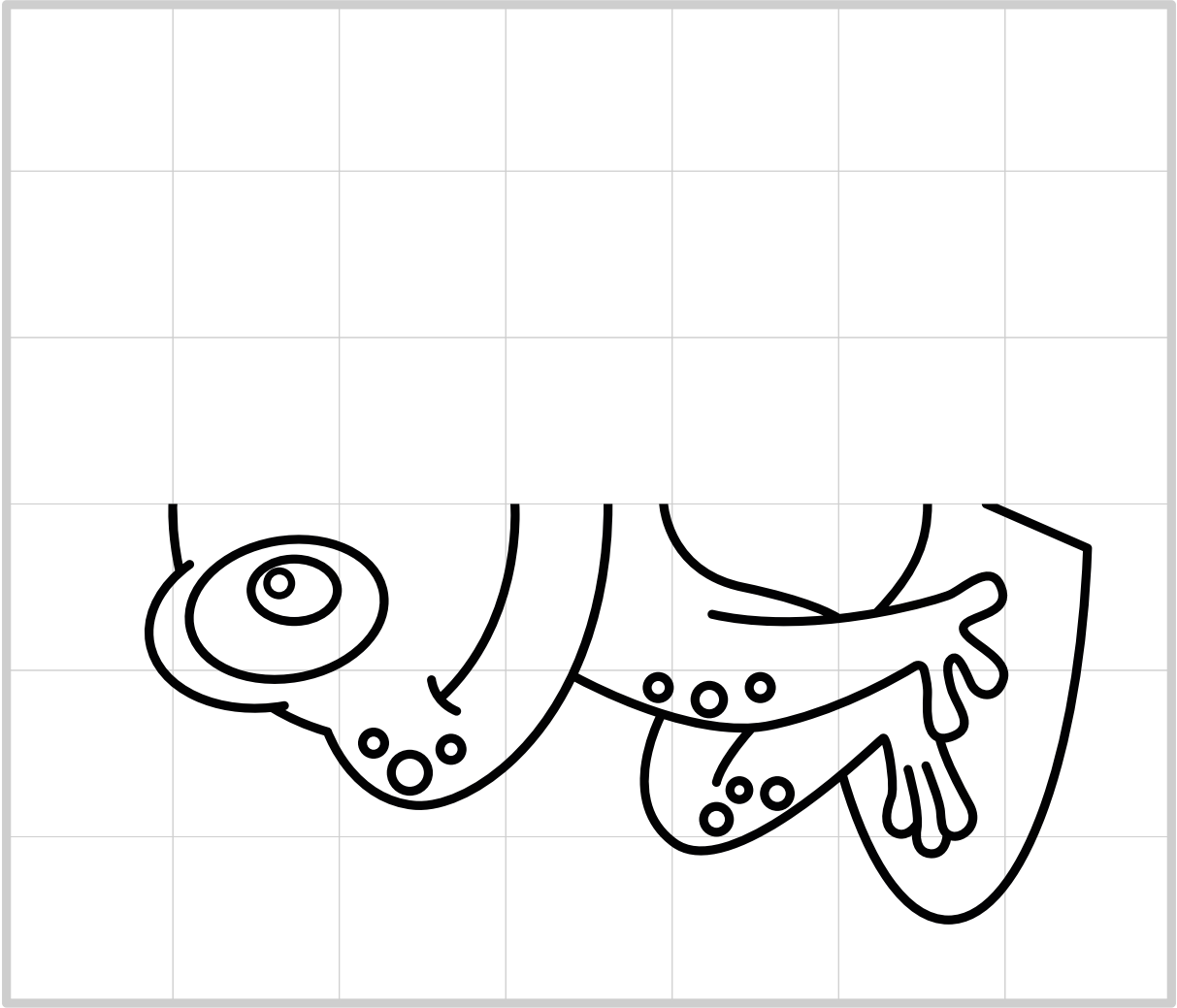

DRAWING

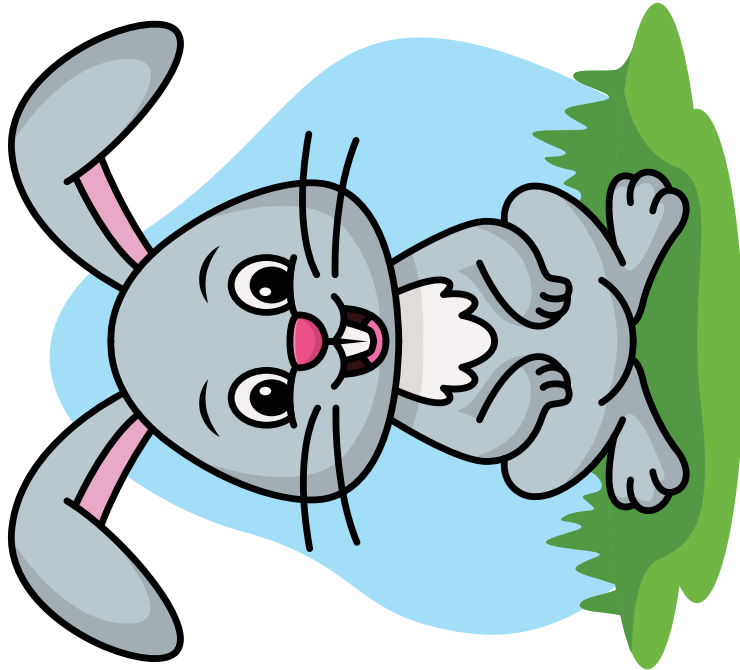
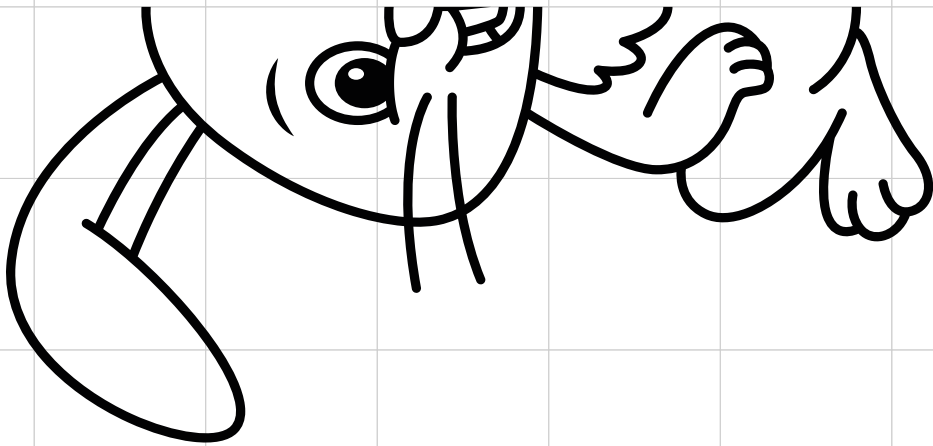

DRAWING

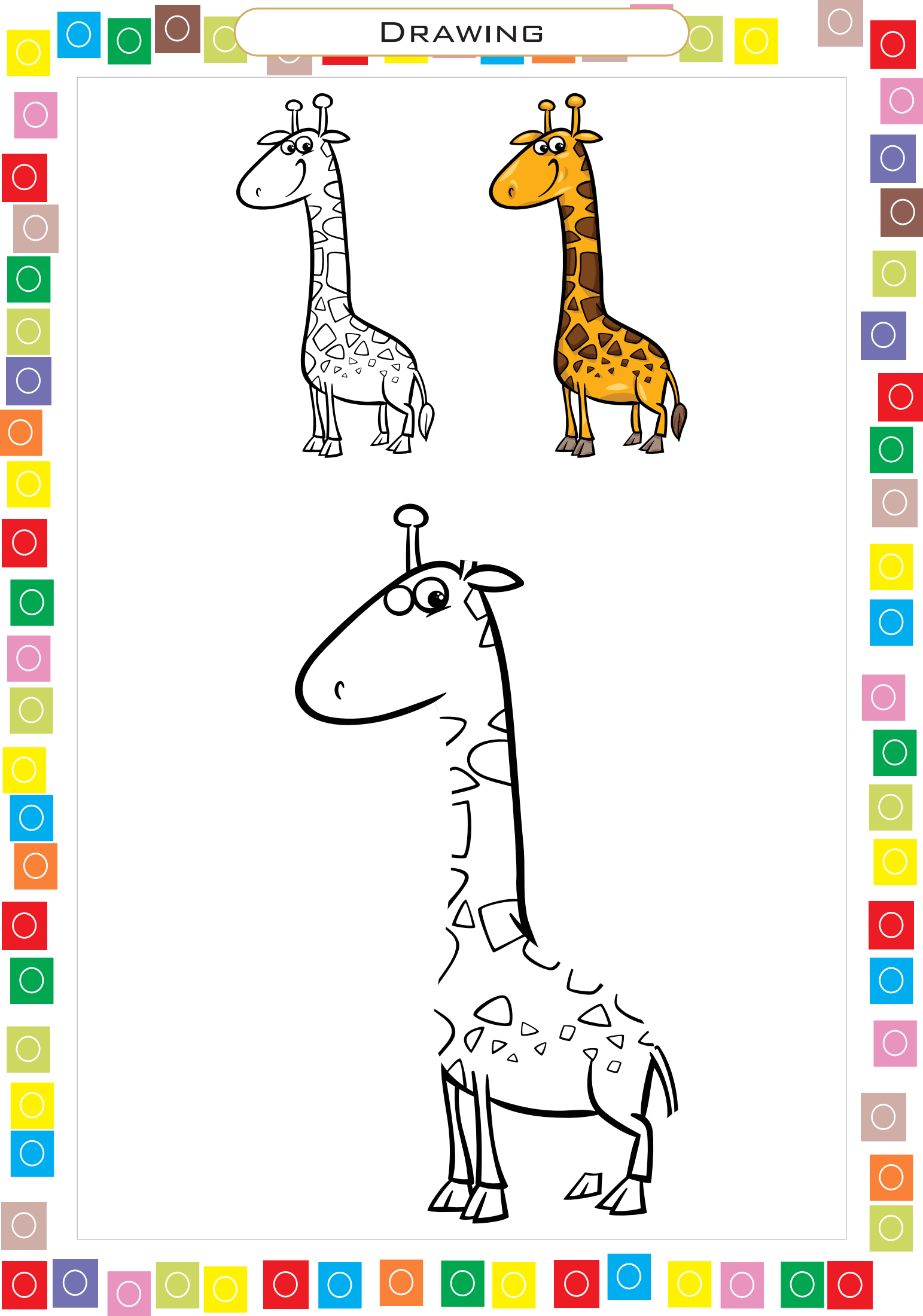
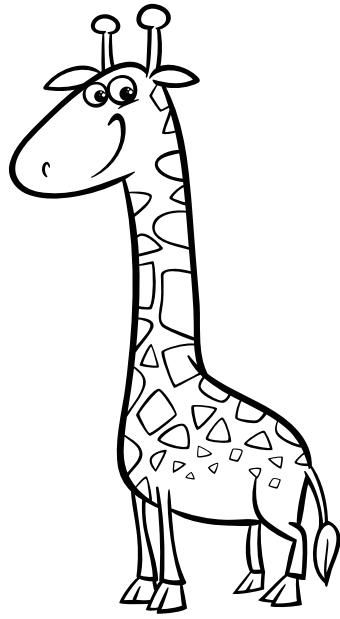

DRAWING



DRAWING



DRAWING



DRAWING

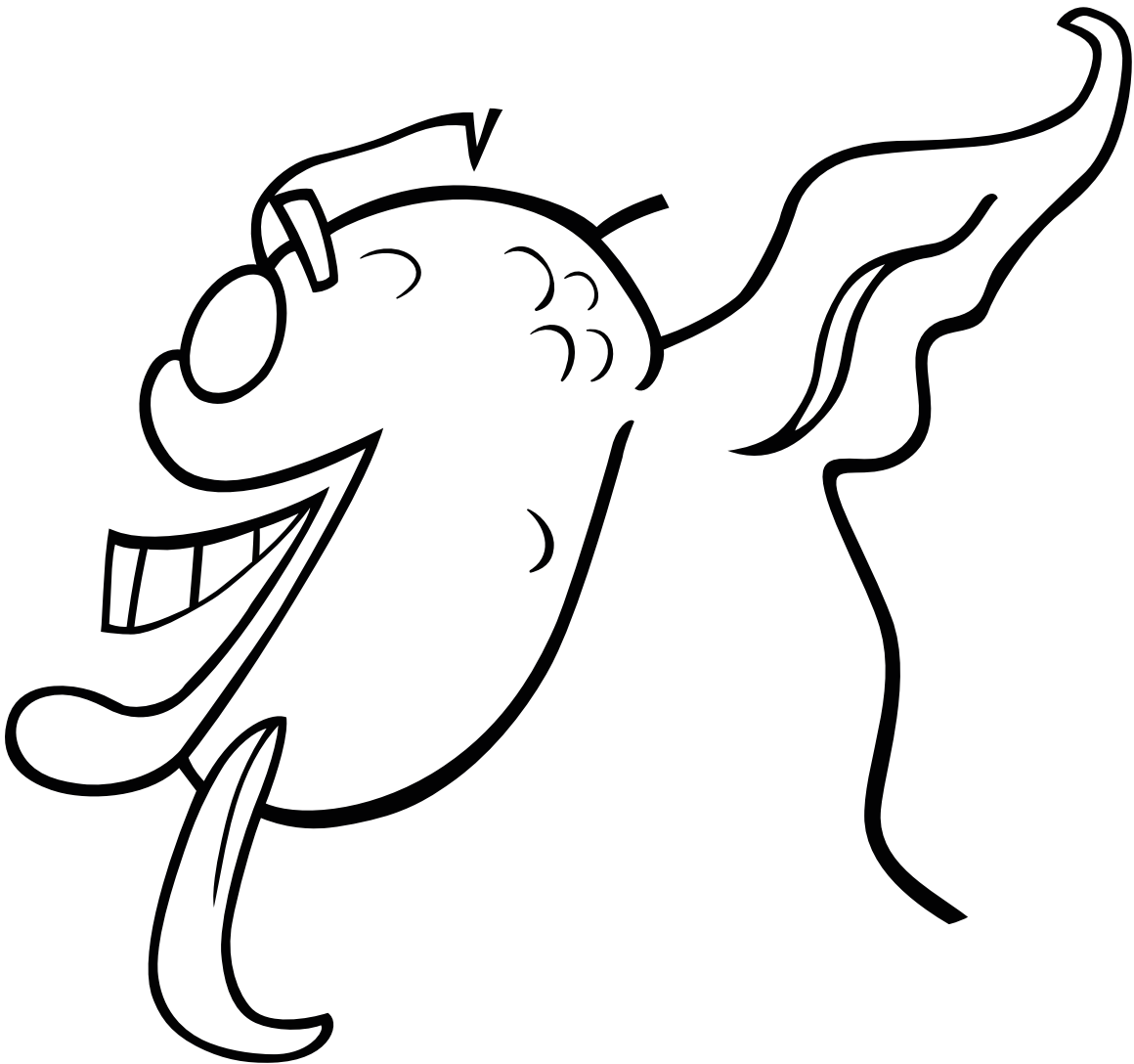
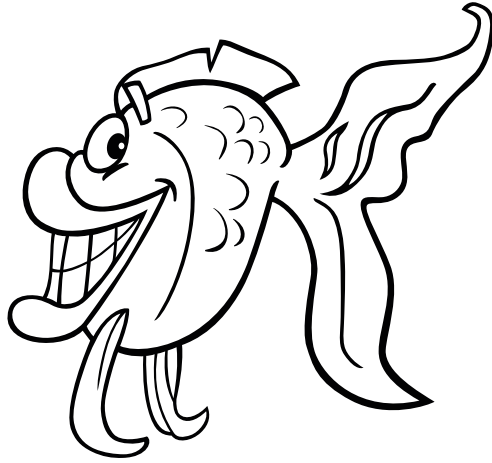

DRAWING



DRAWING

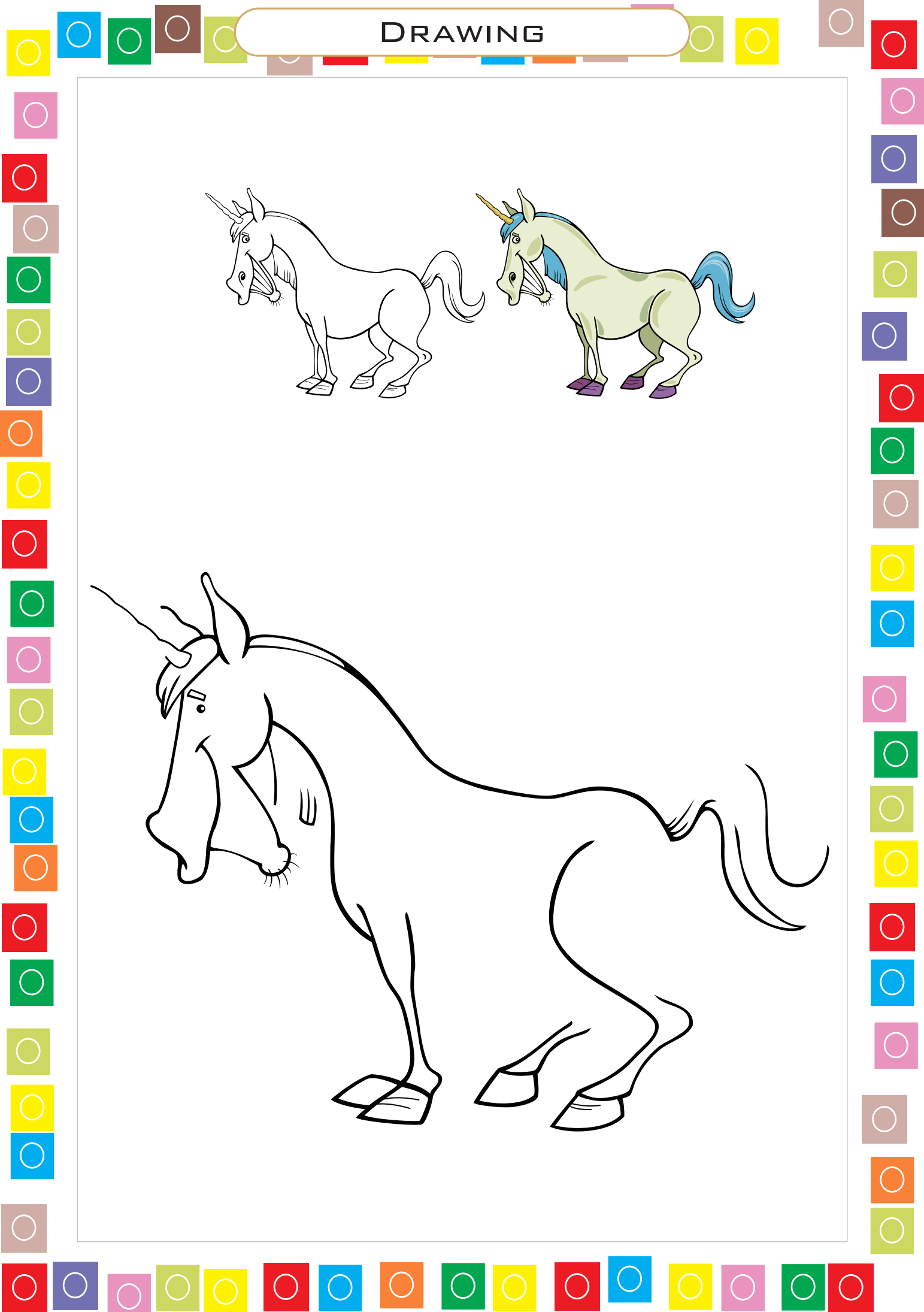
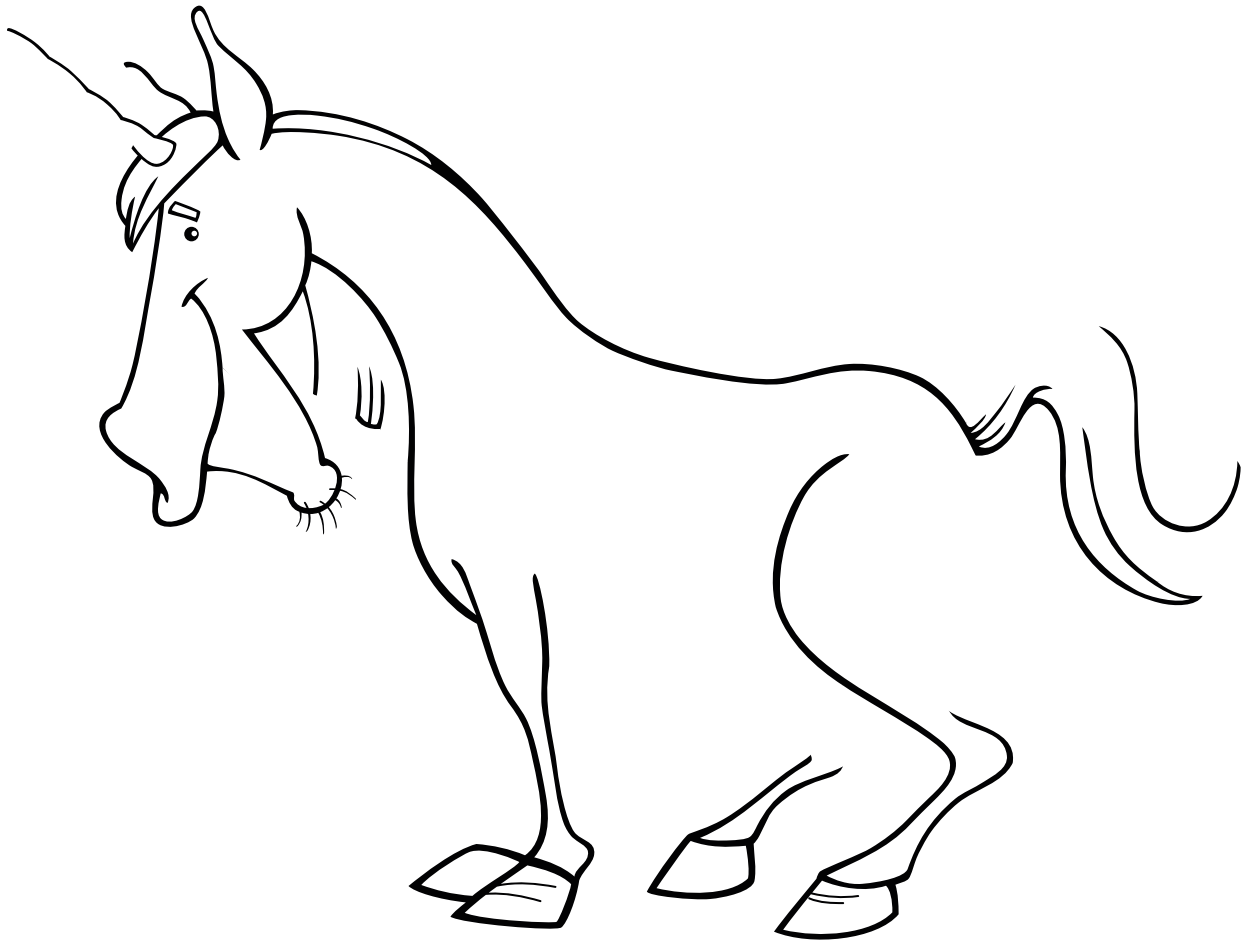
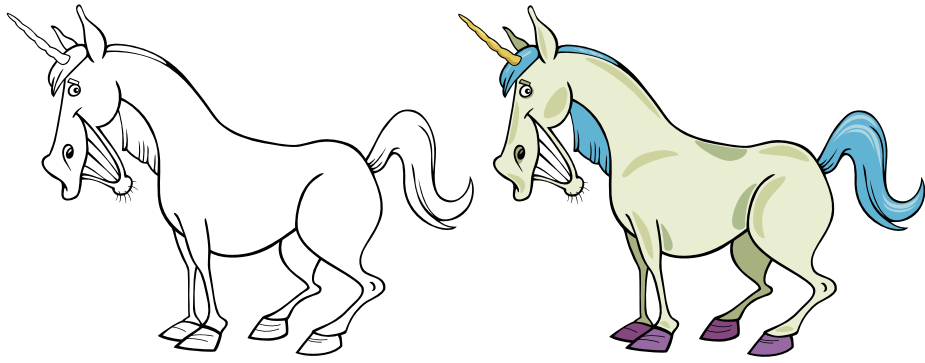

DRAWING



DRAWING

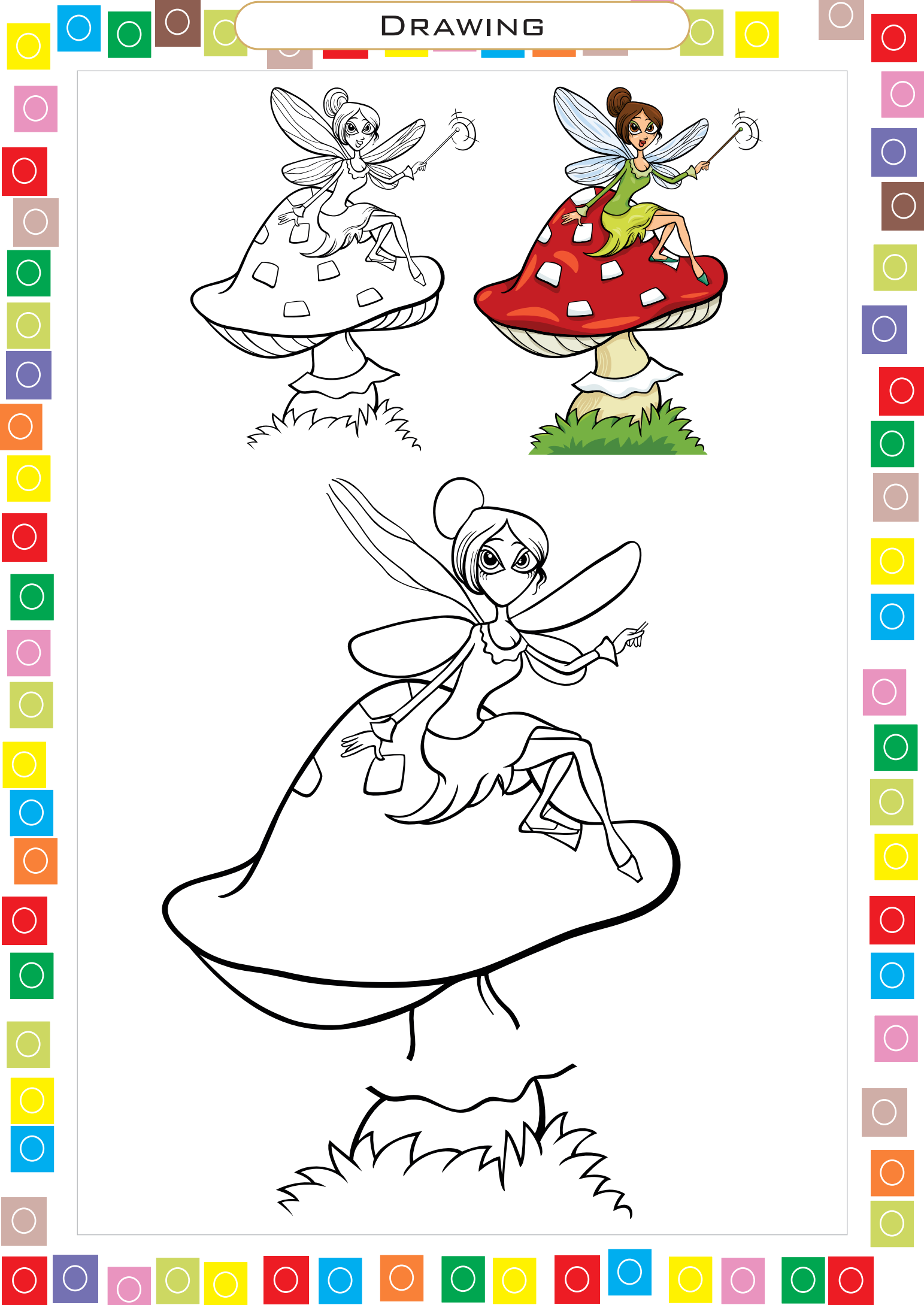

DRAWING



DRAWING

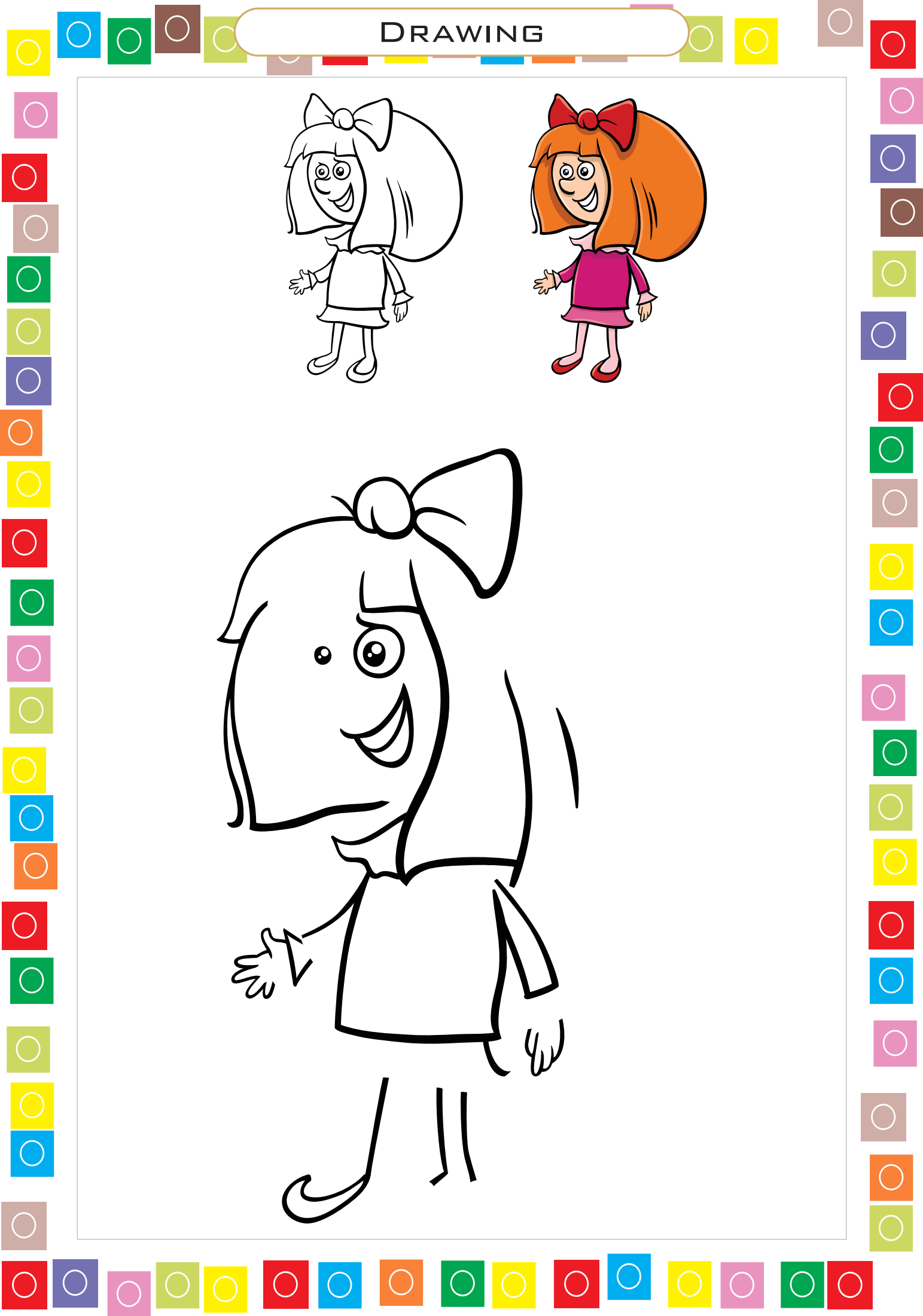
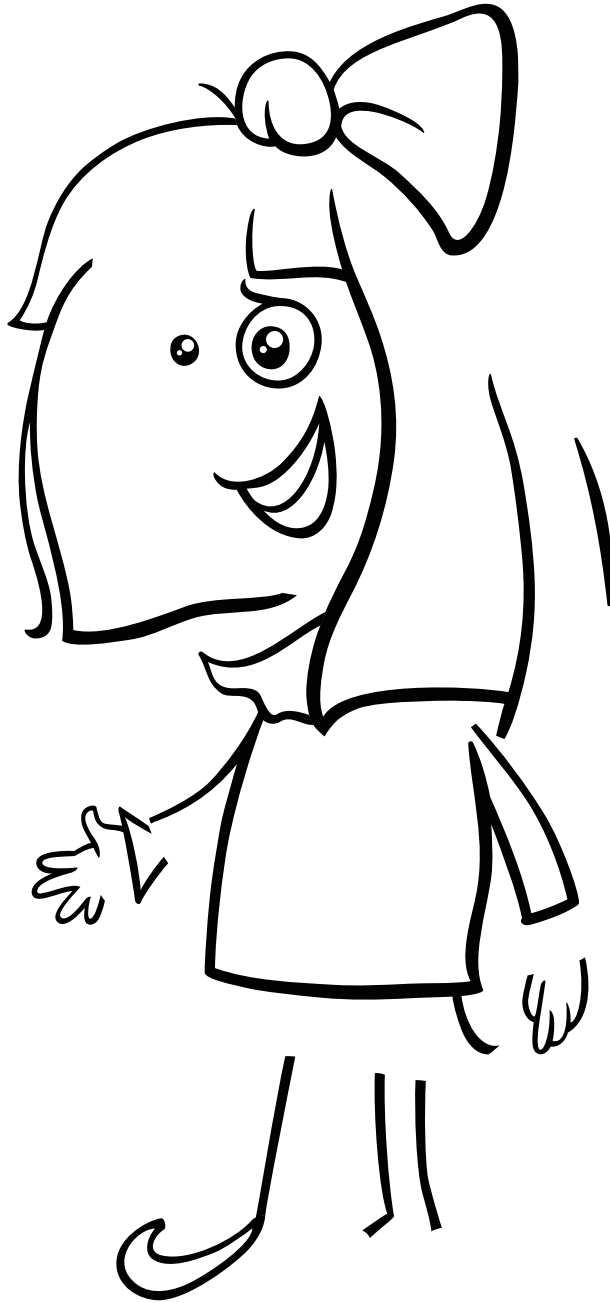
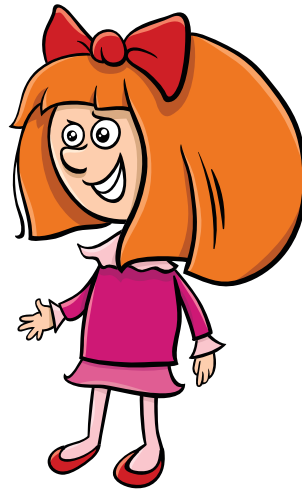

DRAWING

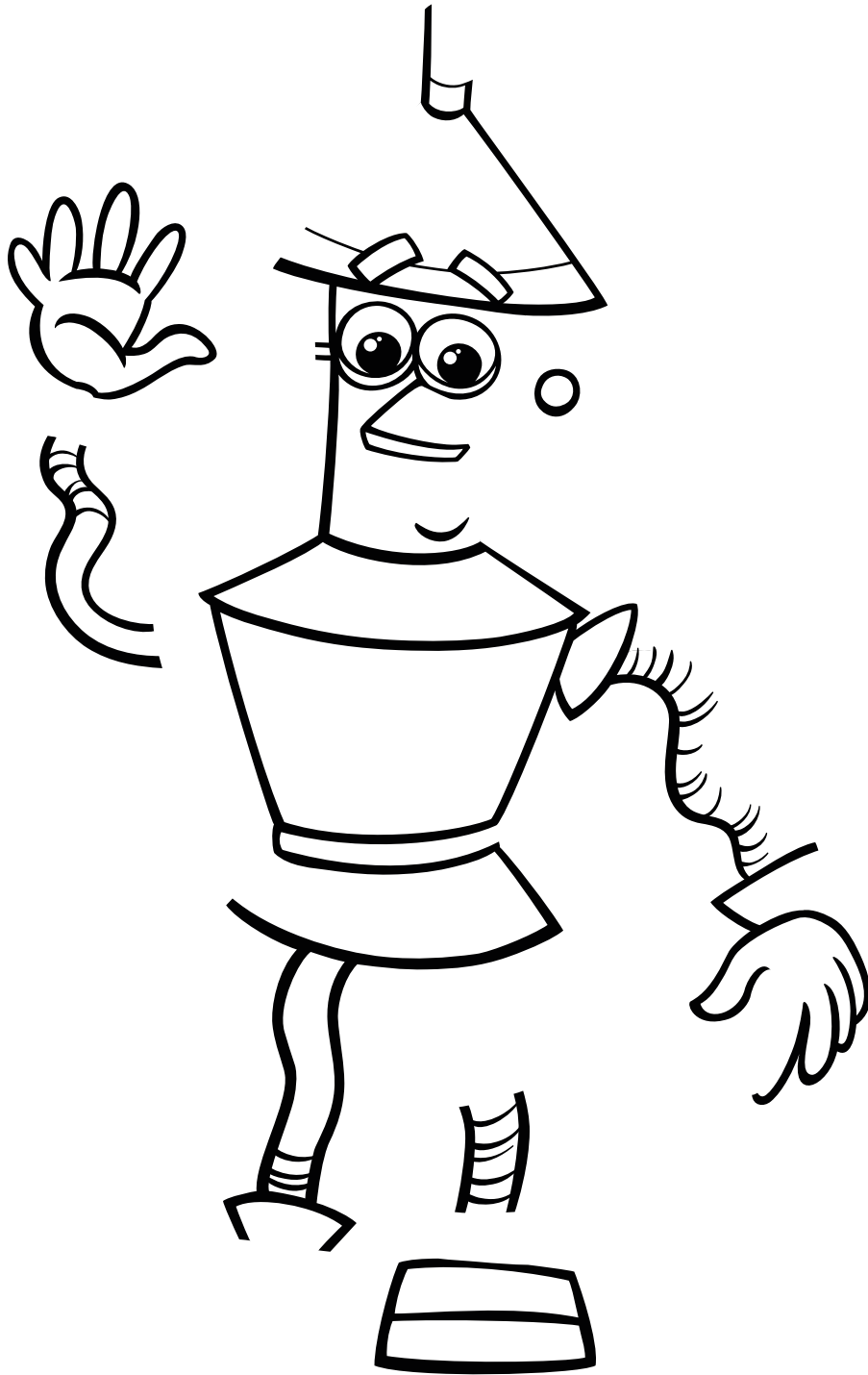
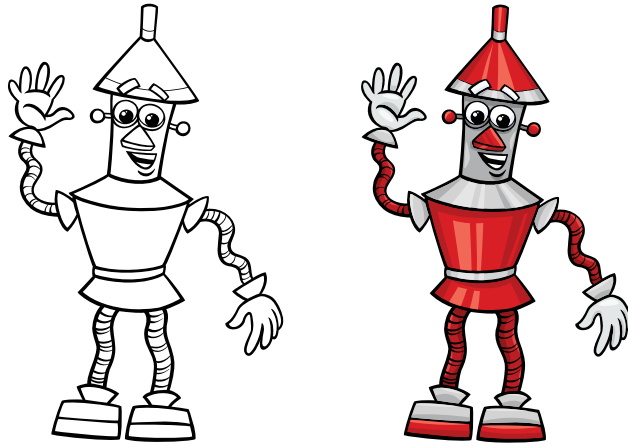

DRAWING

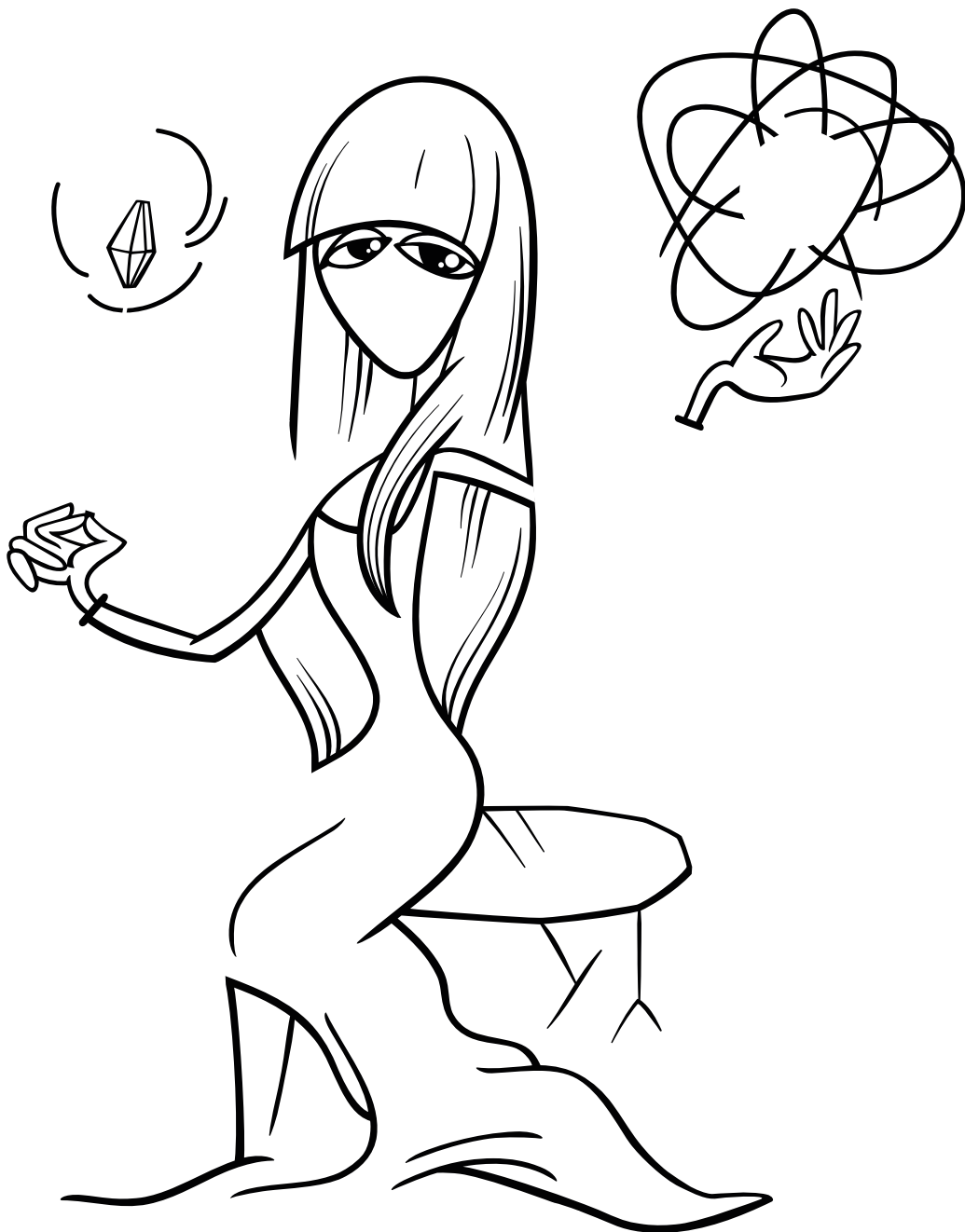

DRAWING

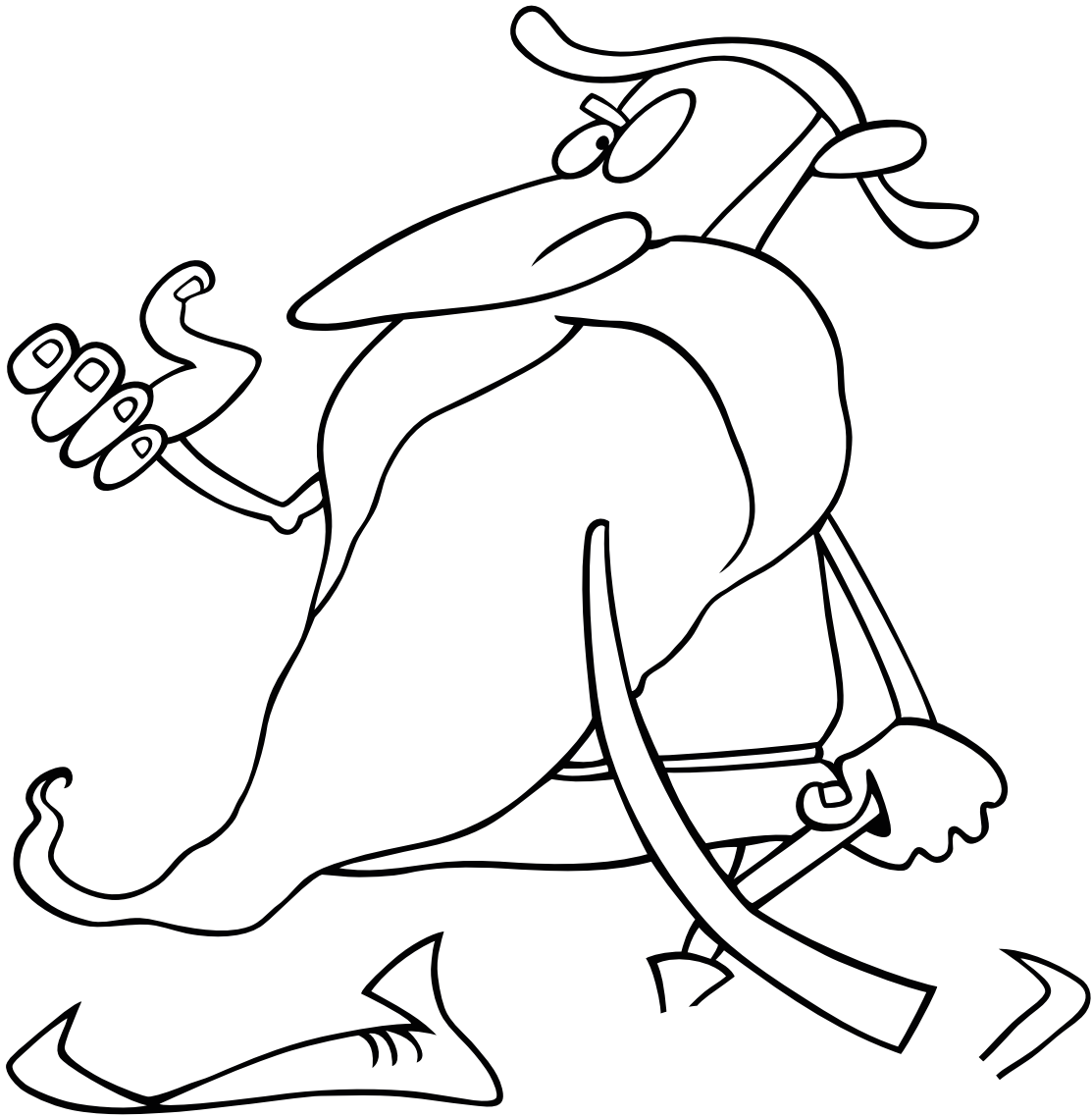

DRAWING

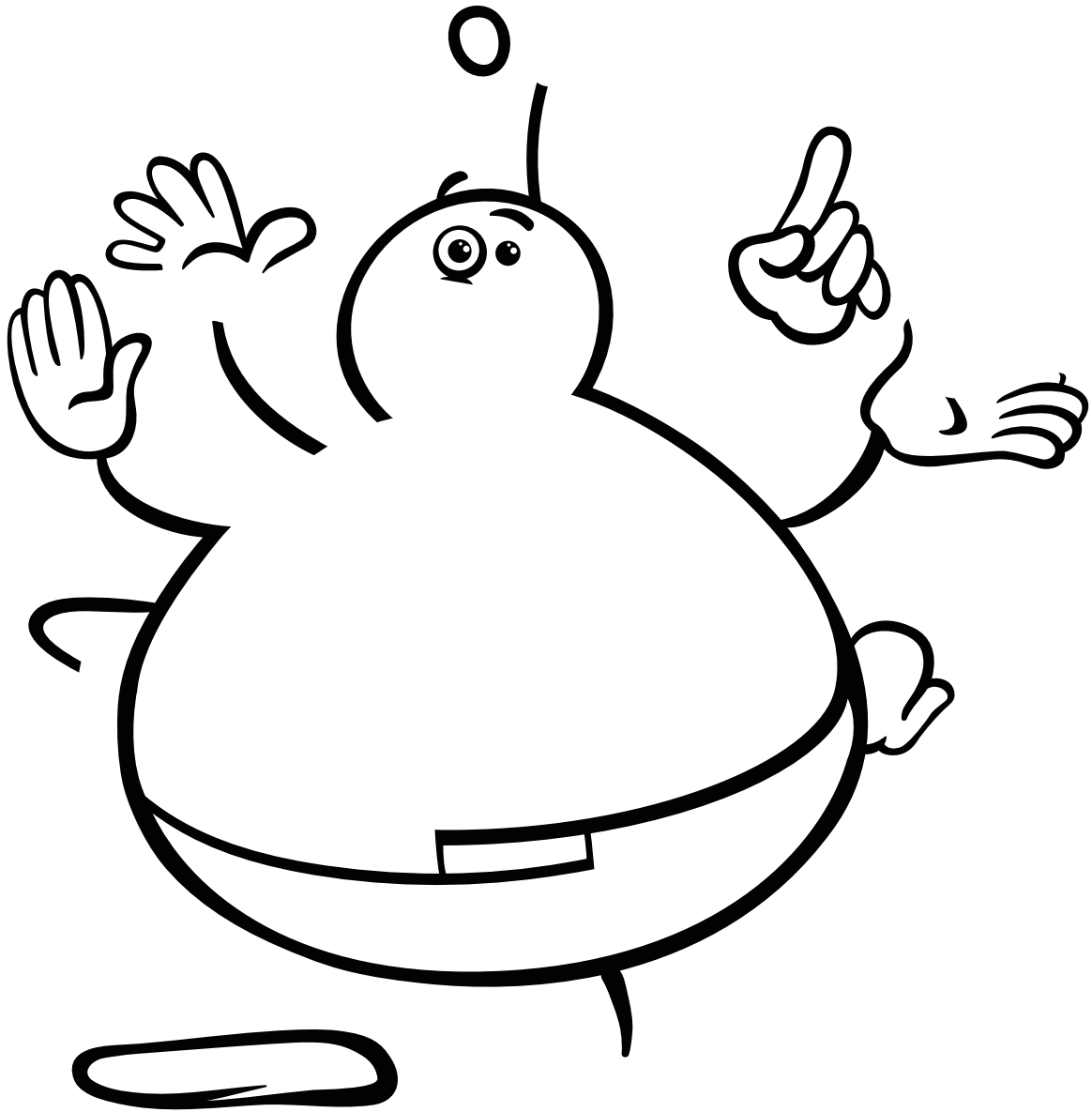
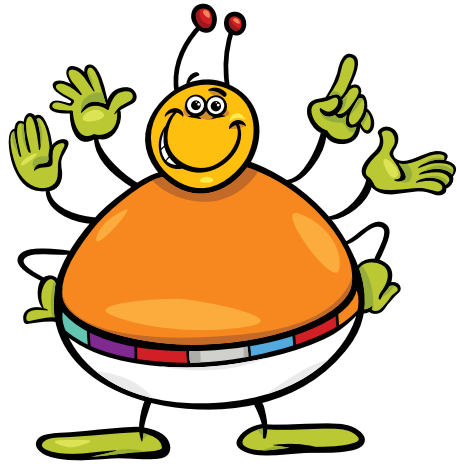
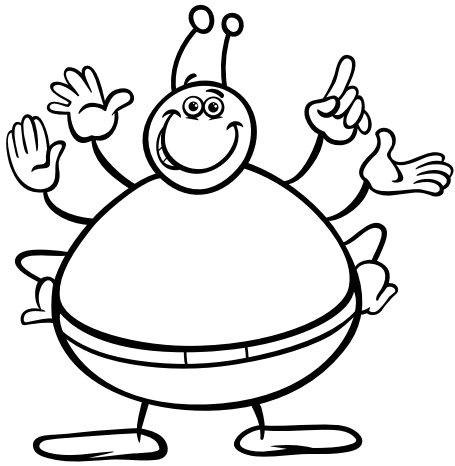

DRAWING

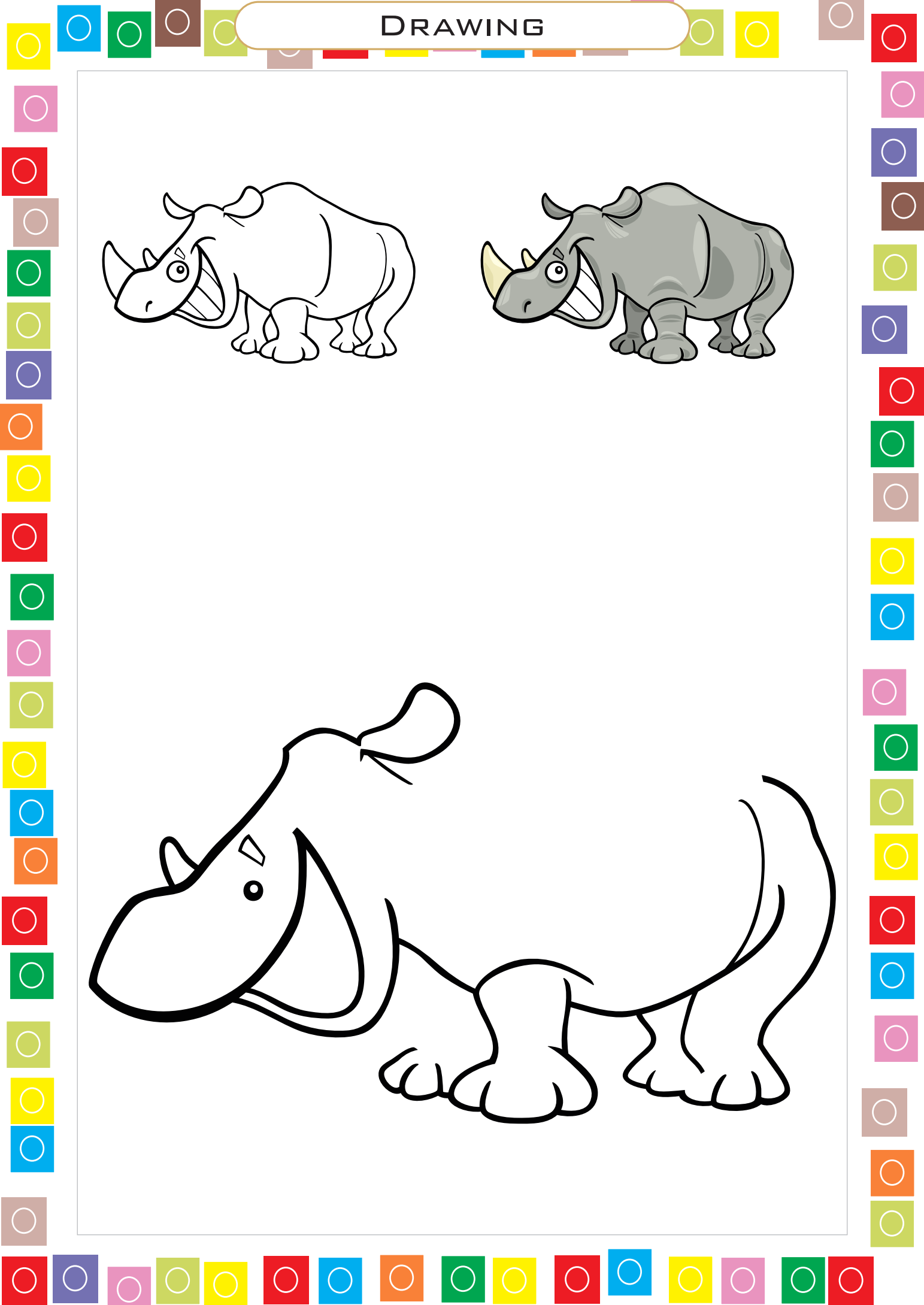
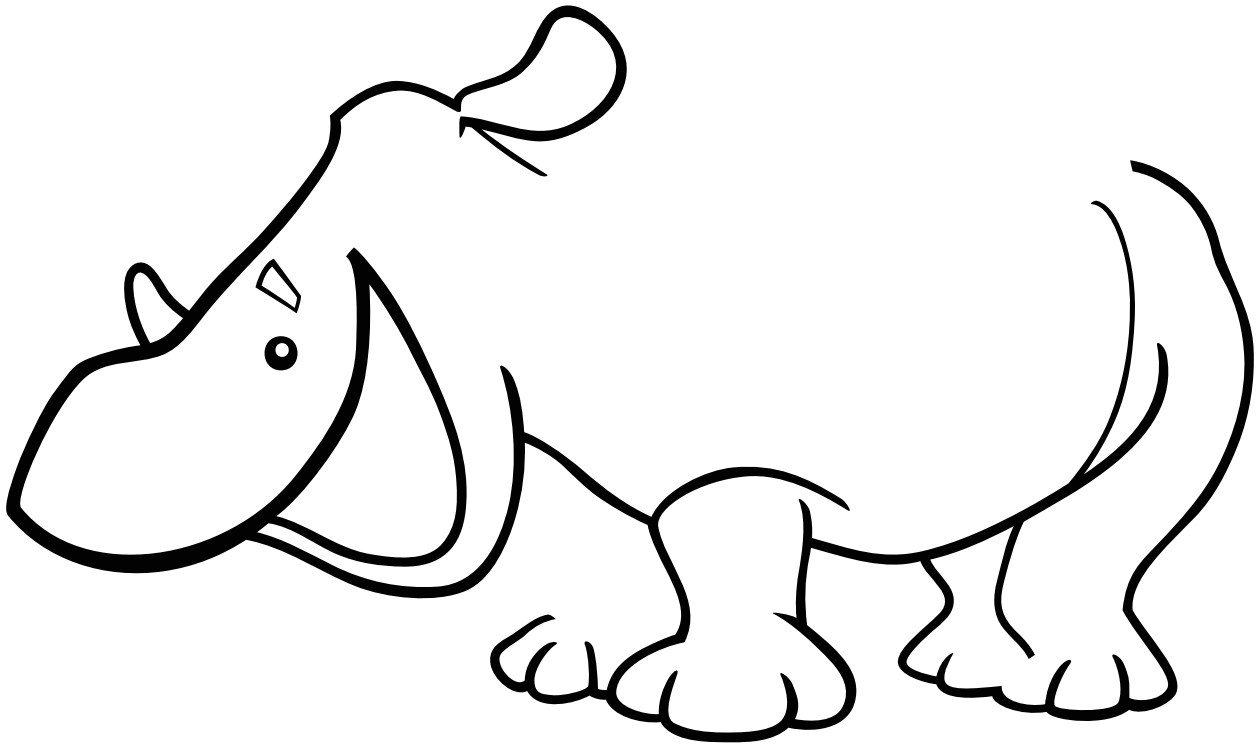
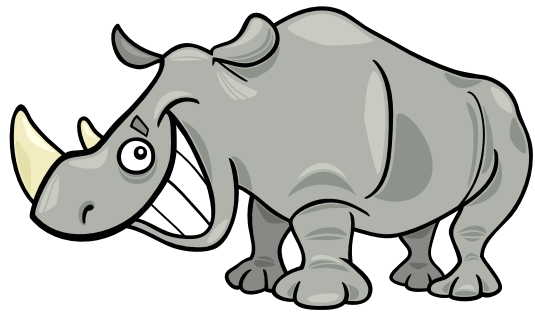
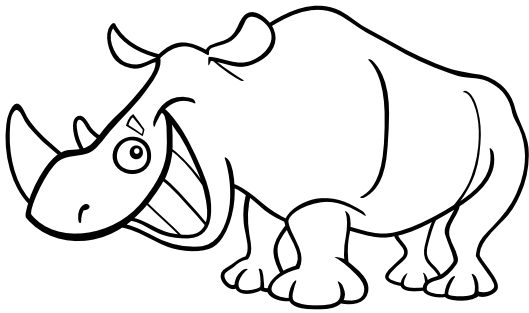

DRAWING

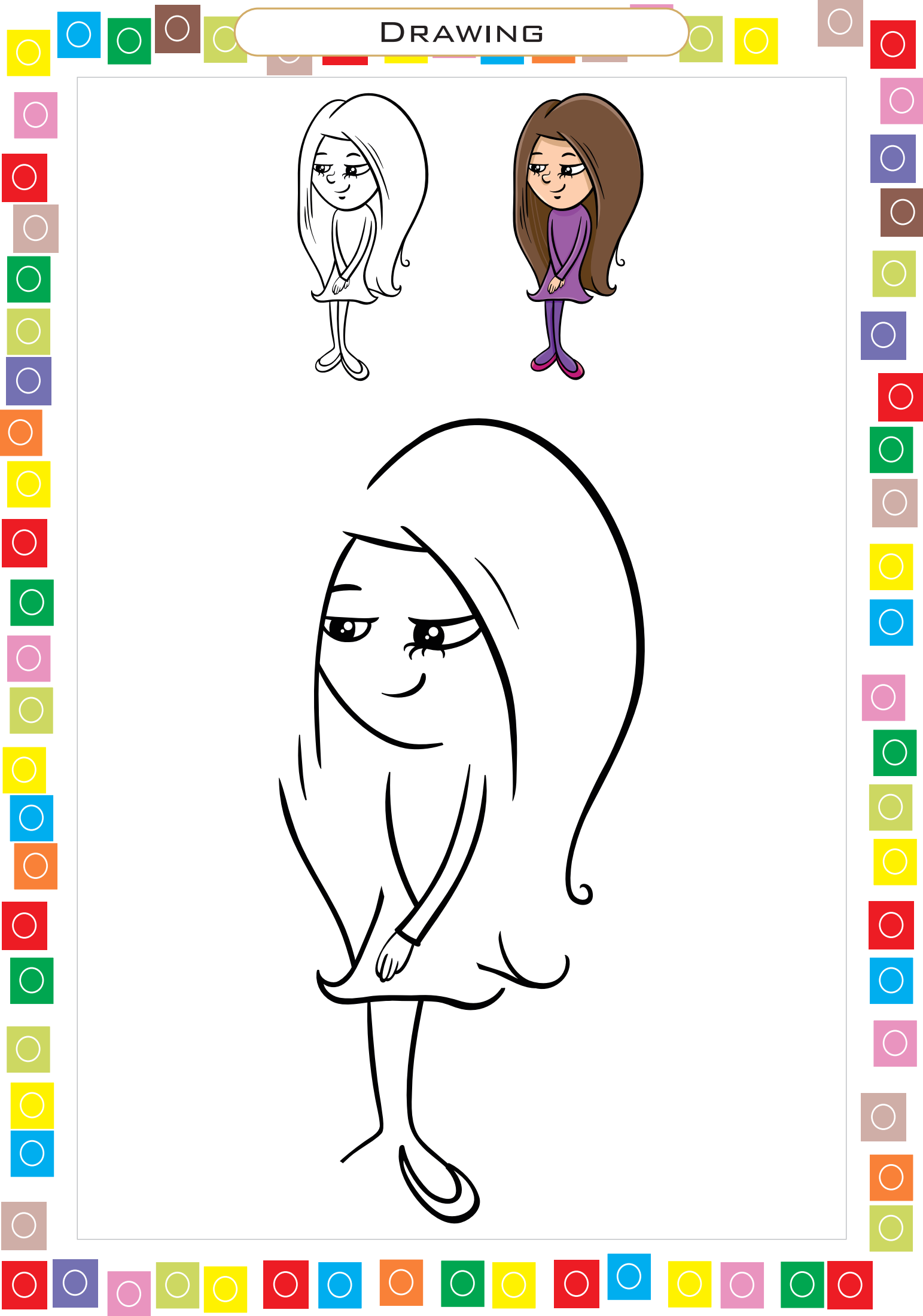
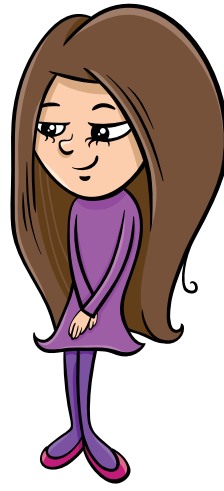
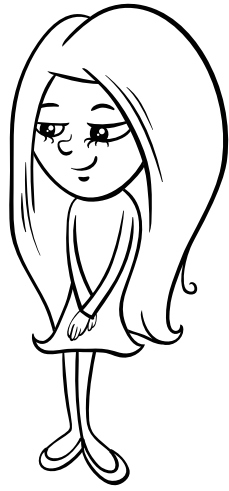

DRAWING

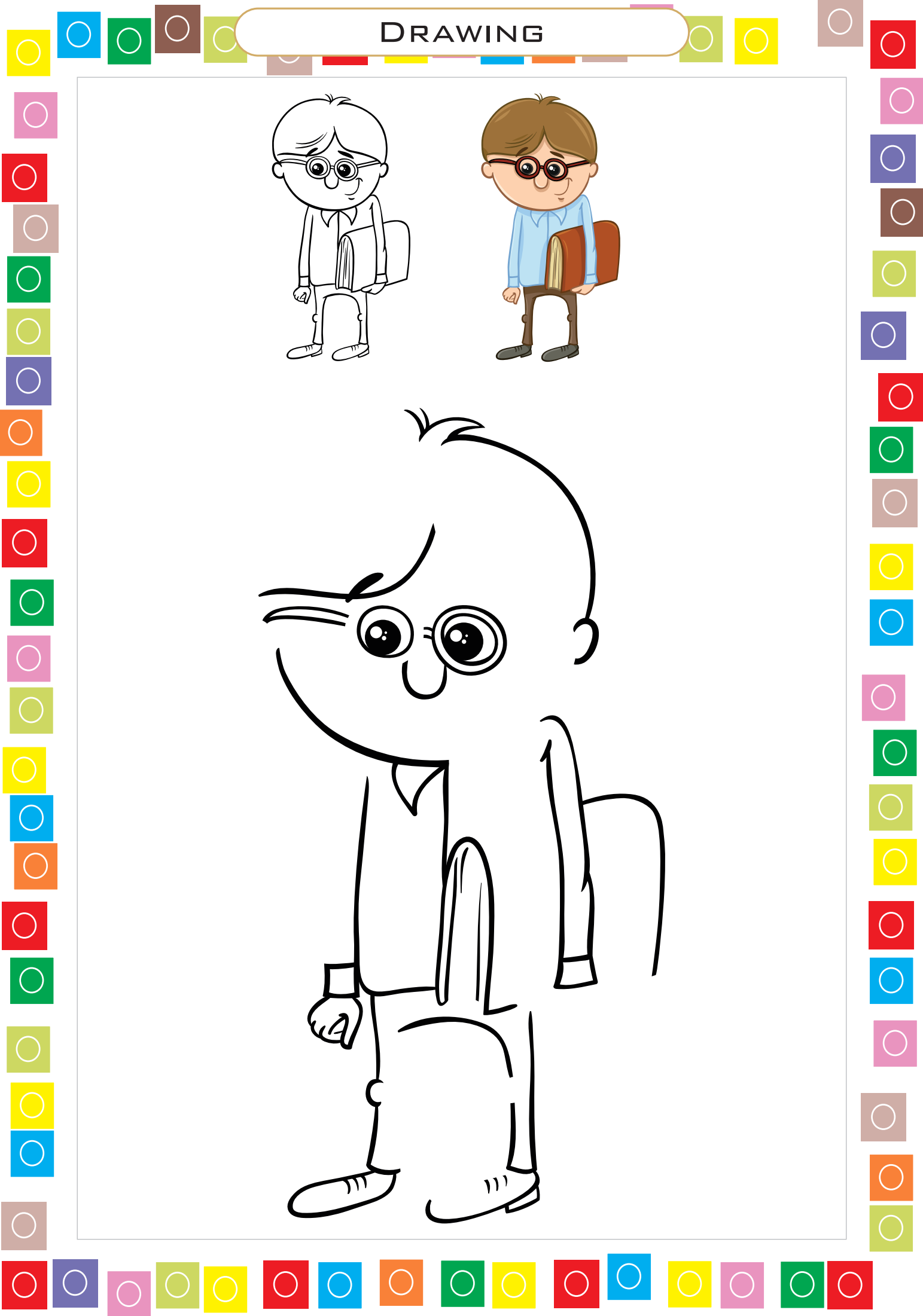
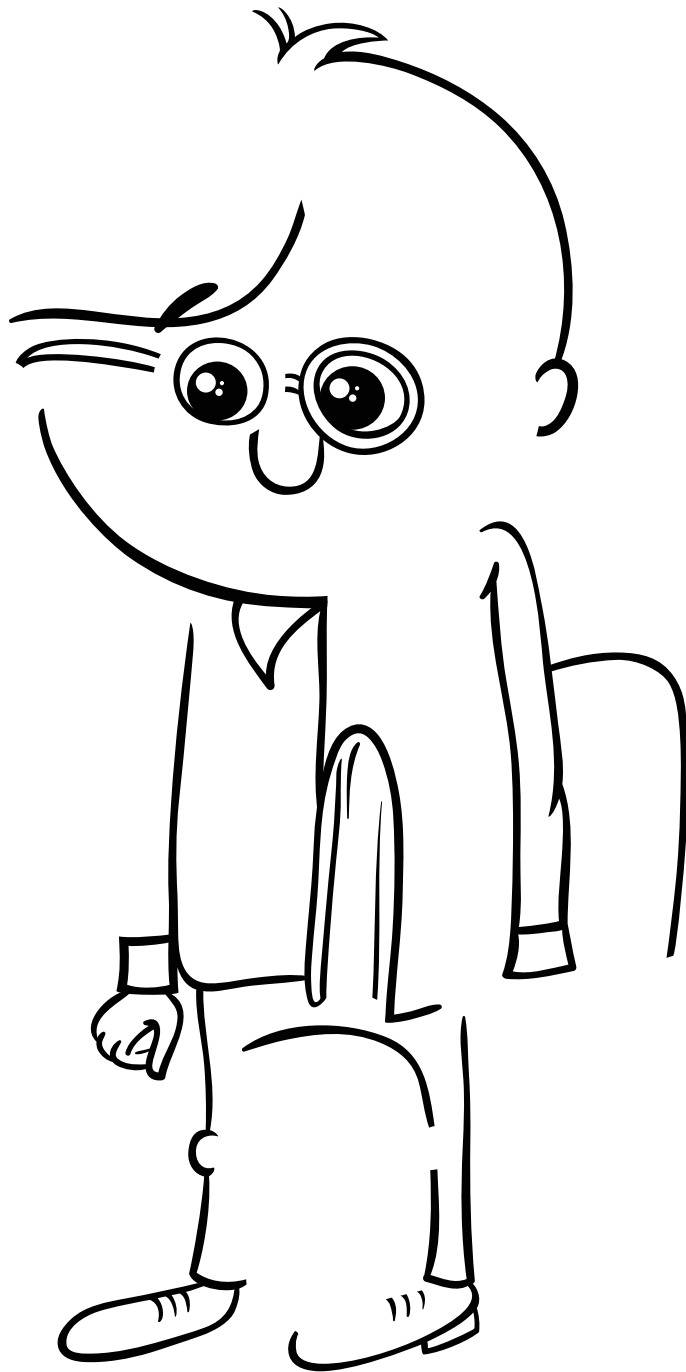
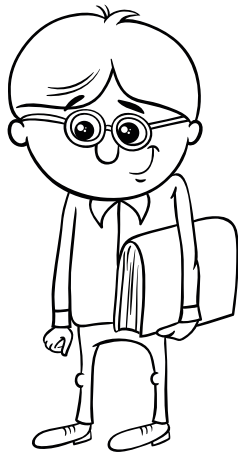

DRAWING

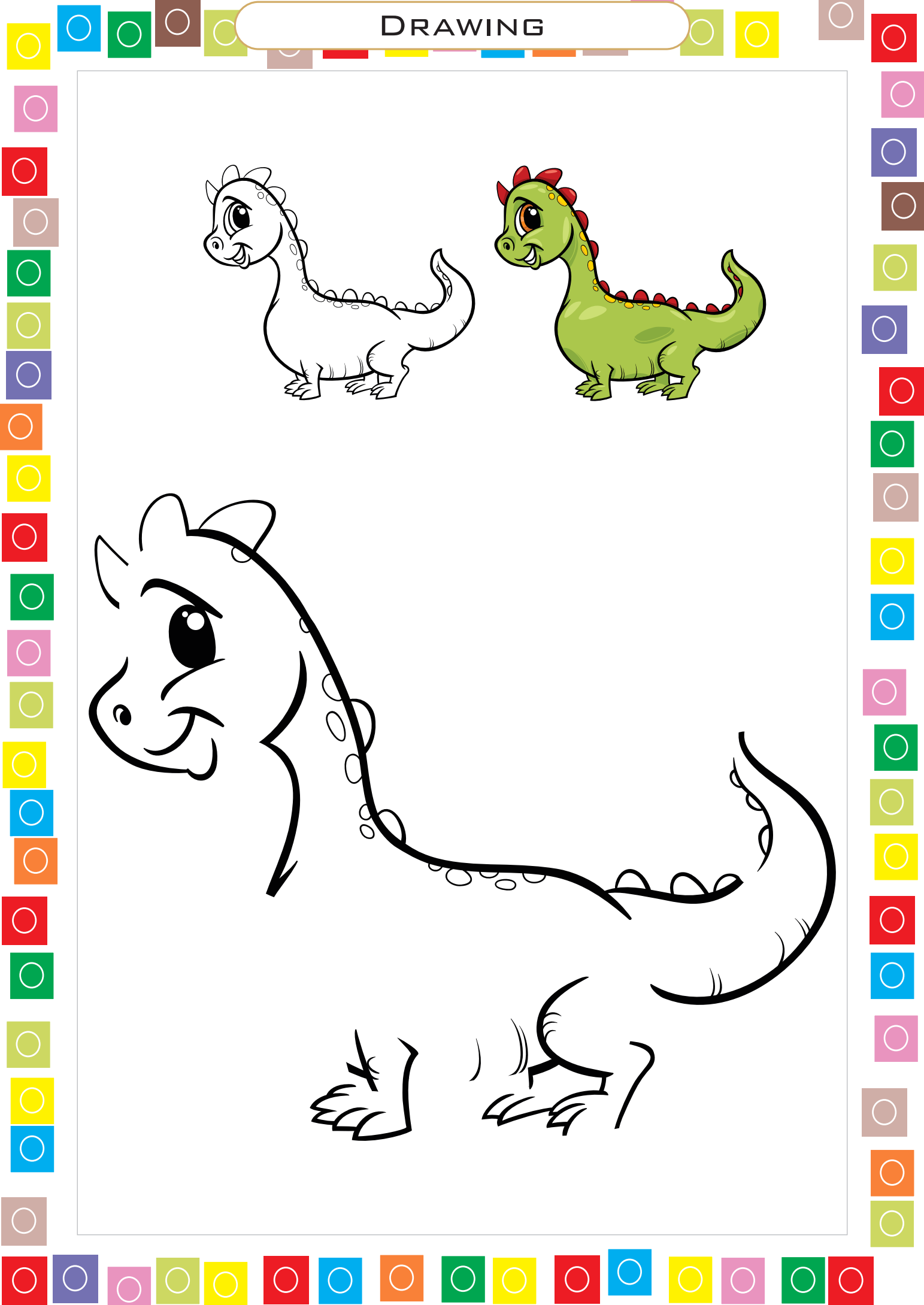
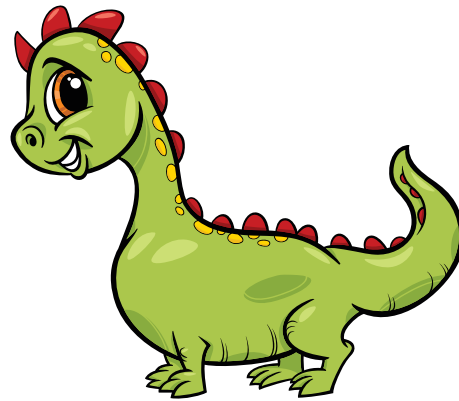
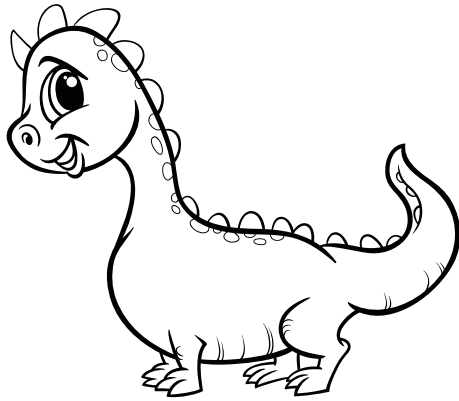

DRAWING

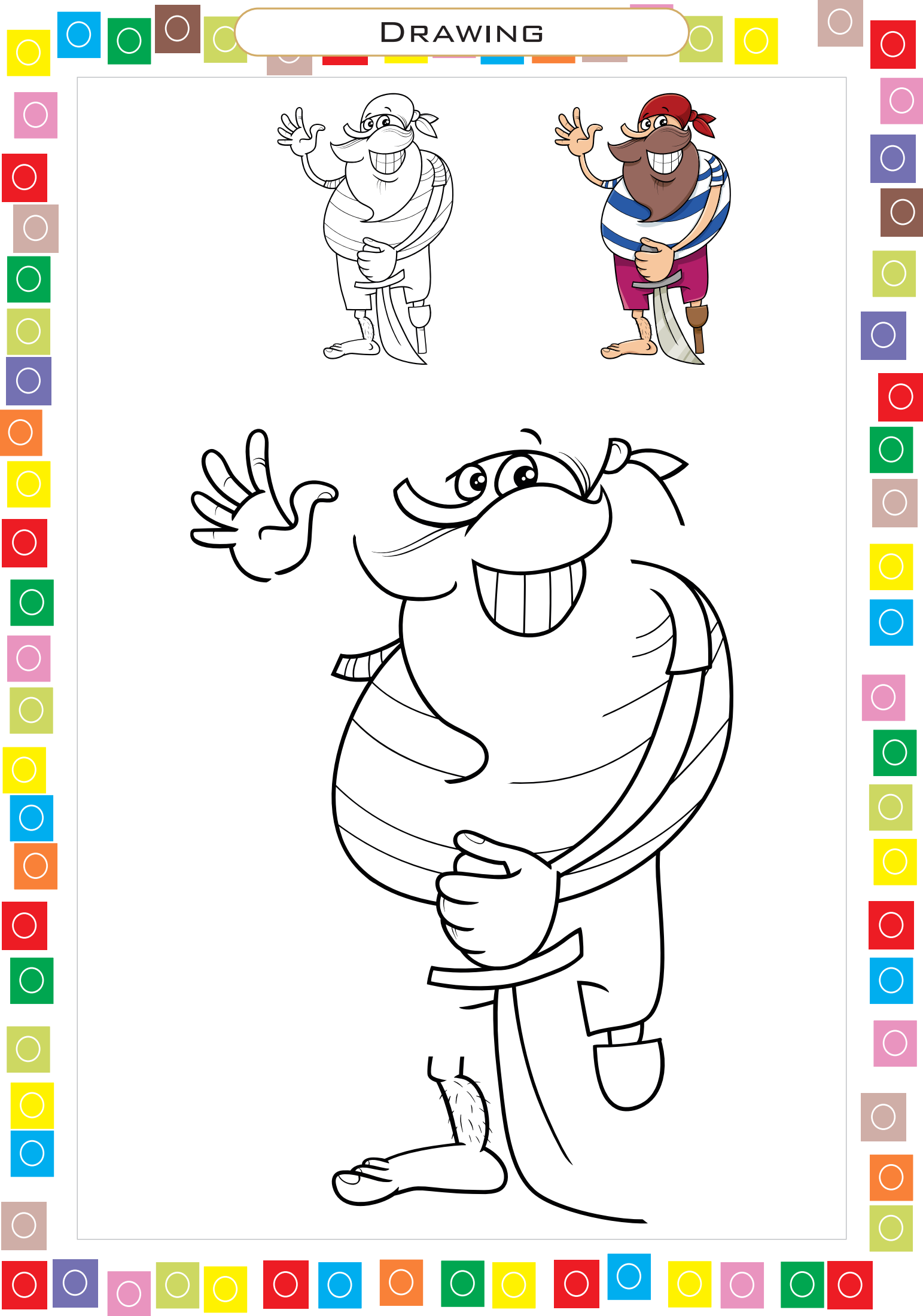

DRAWING

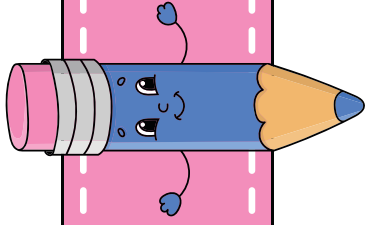

Copy the picture

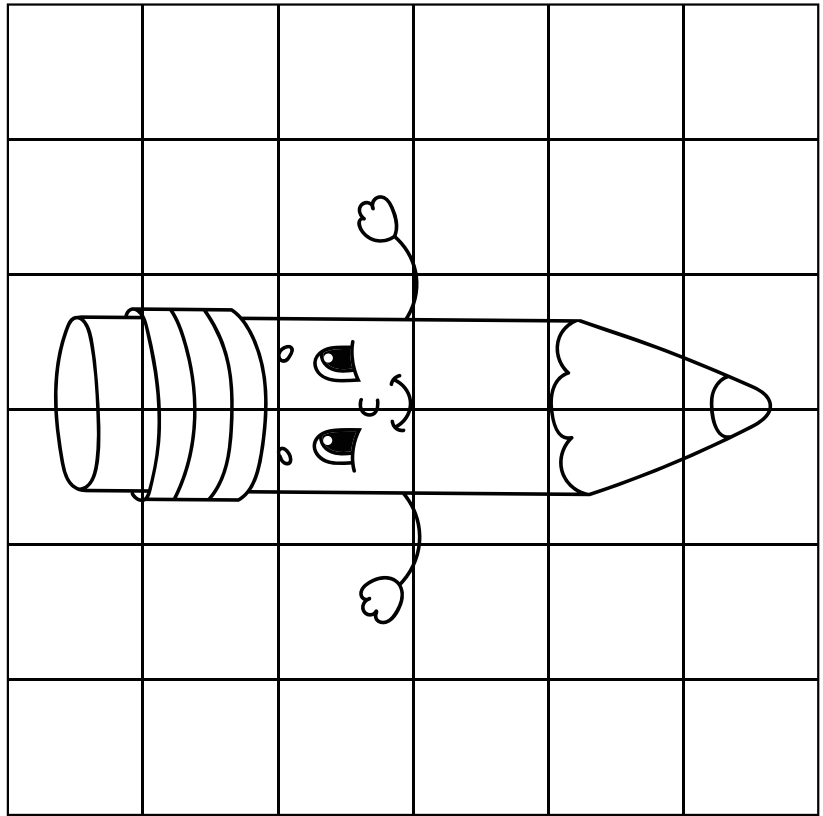
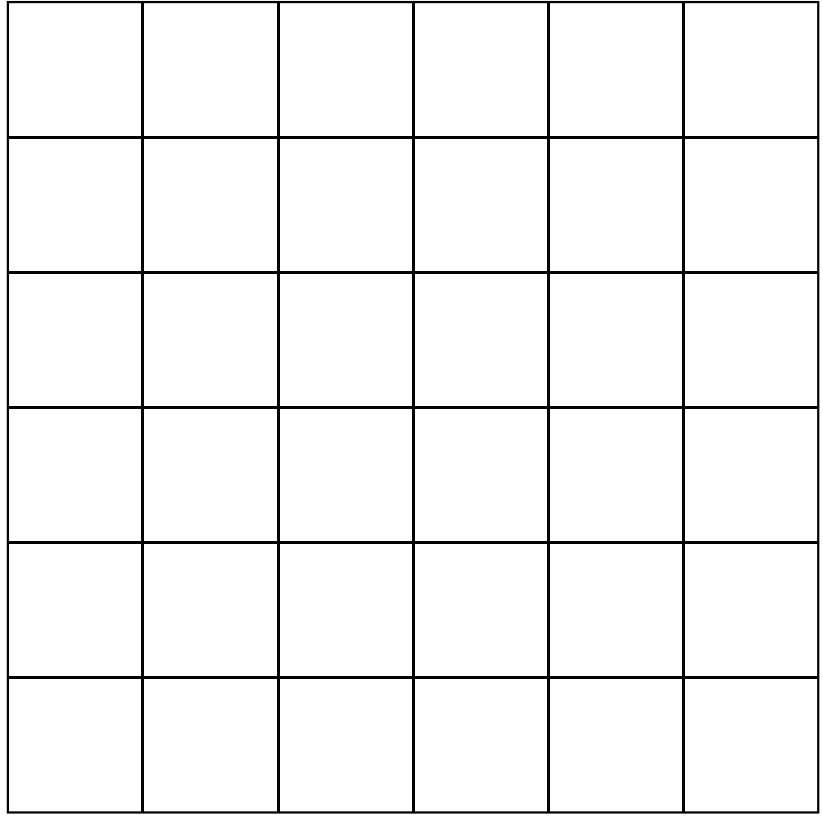

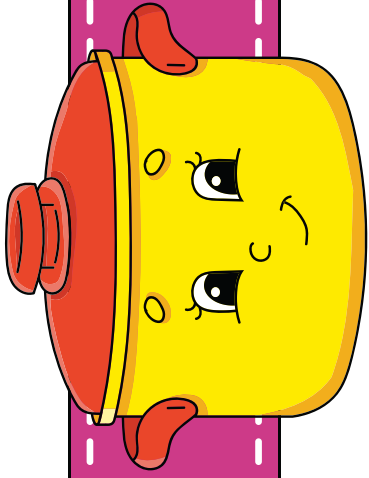

Copy the picture

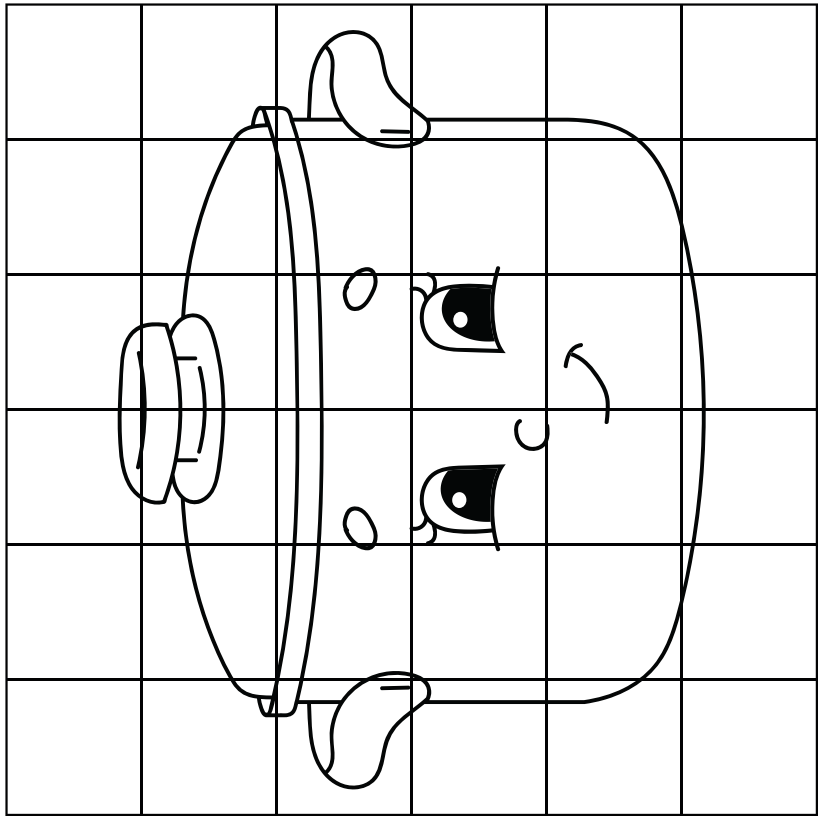
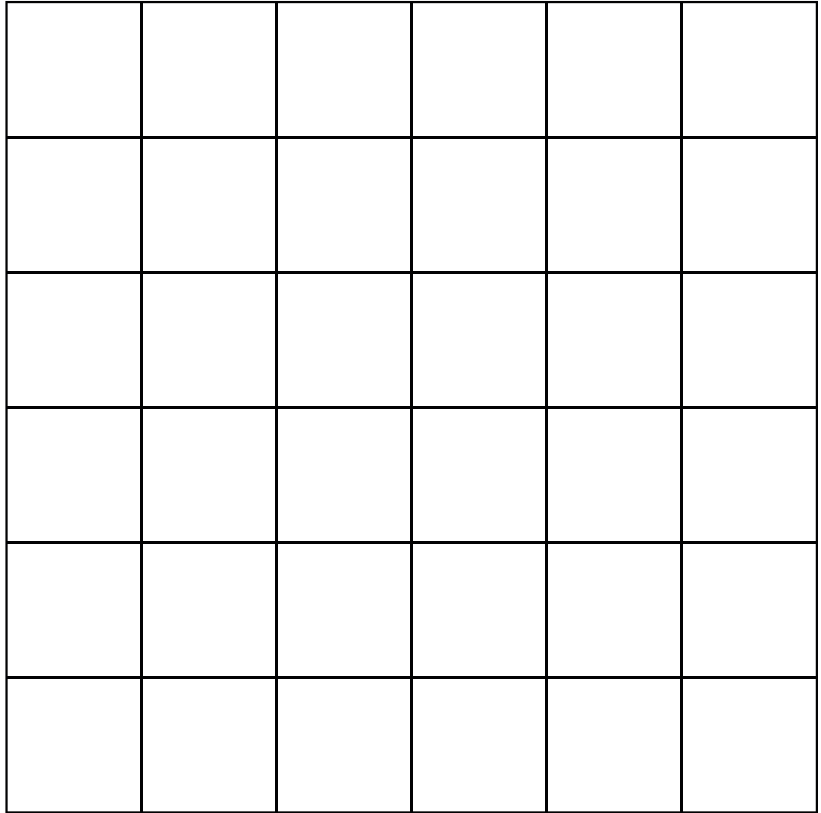

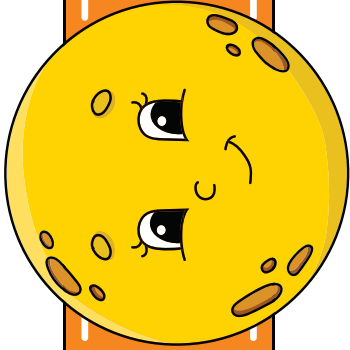

Copy the picture

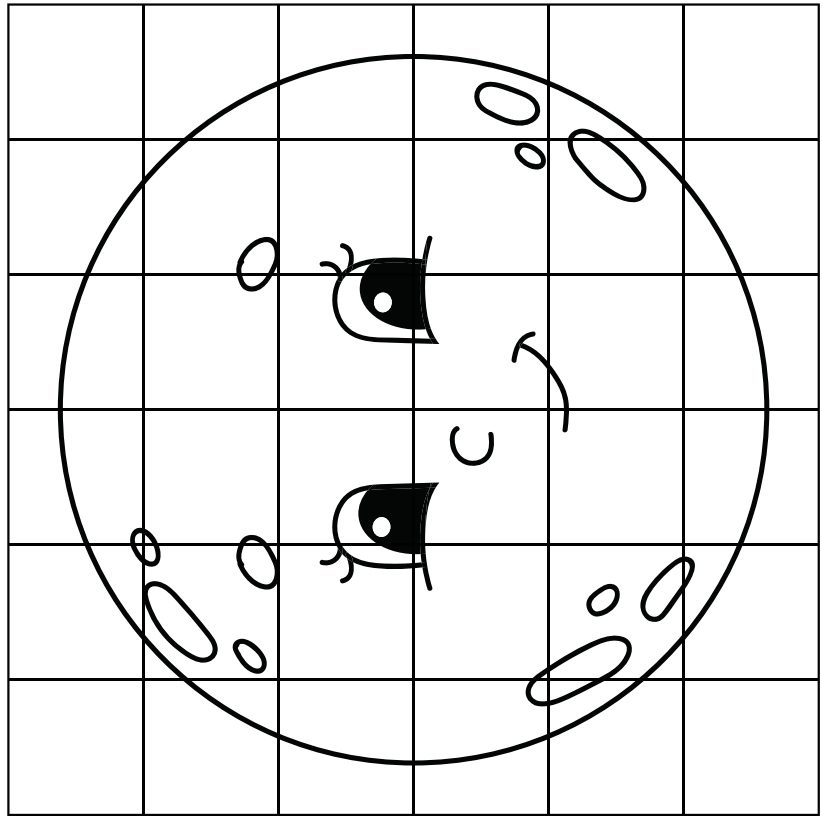
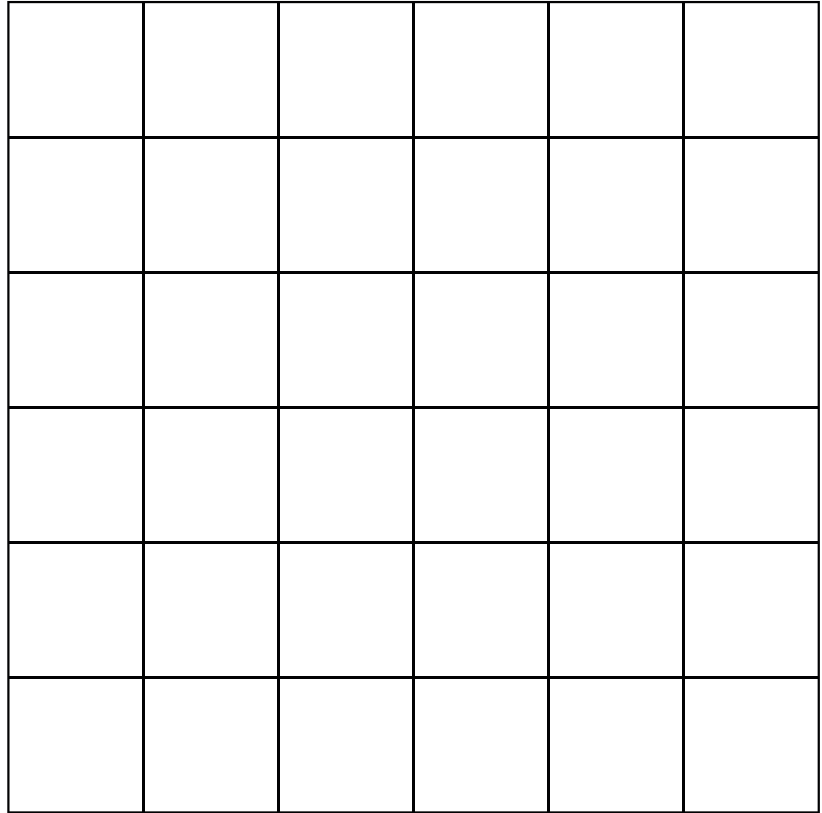

DRAWING

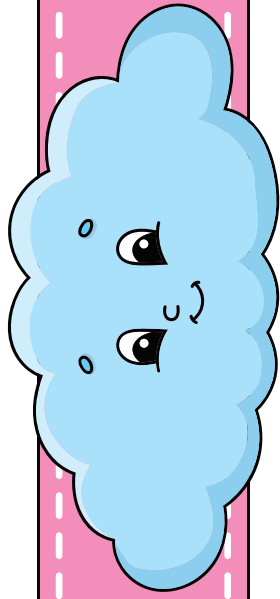

Copy the picture

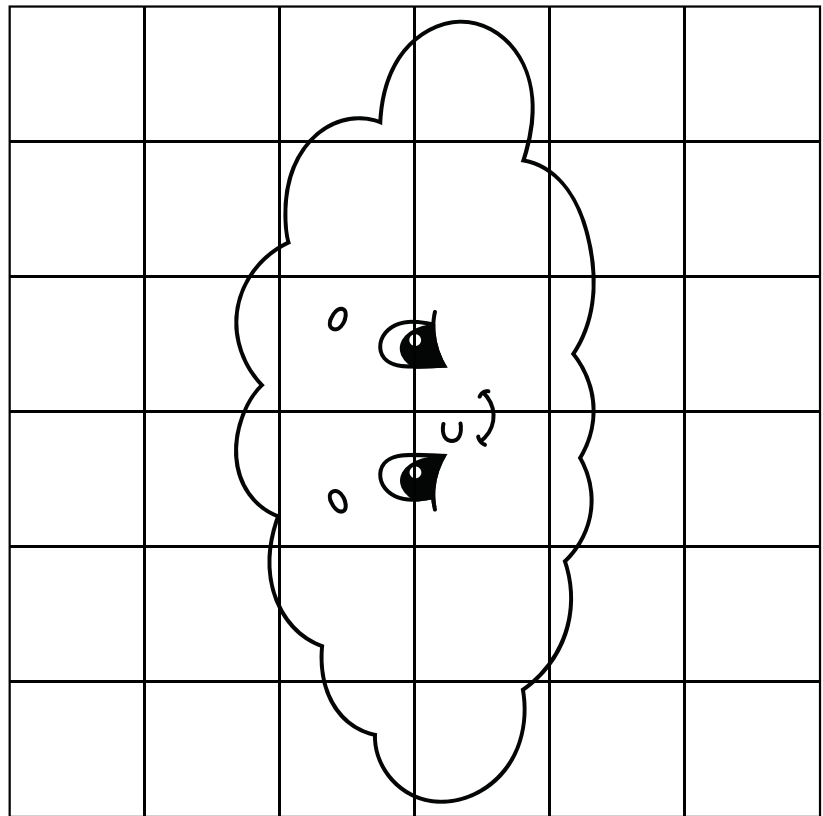
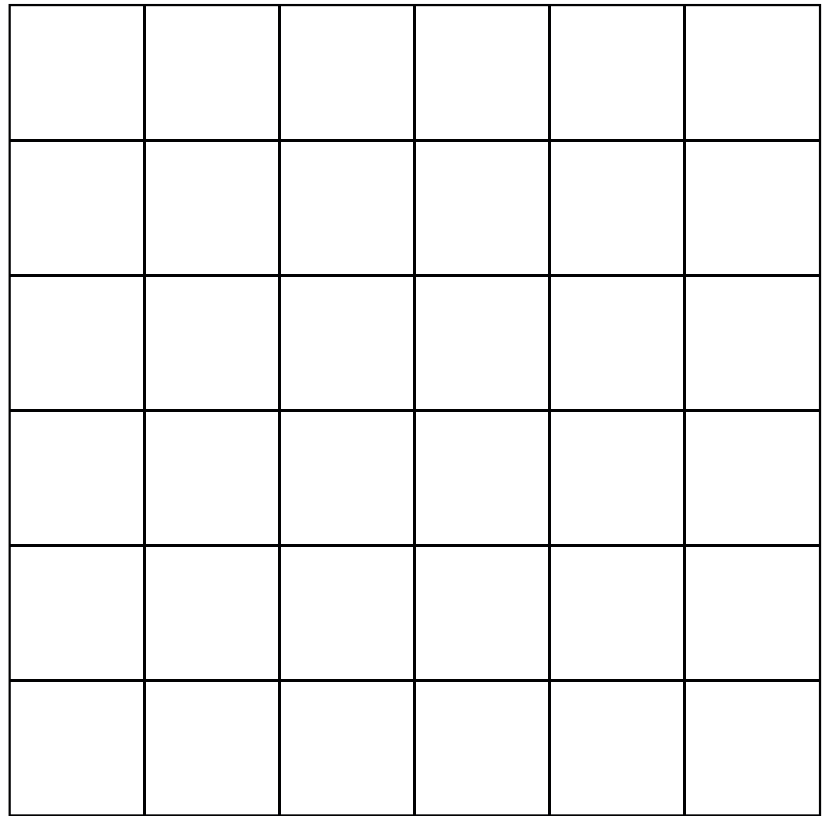

Copy the picture

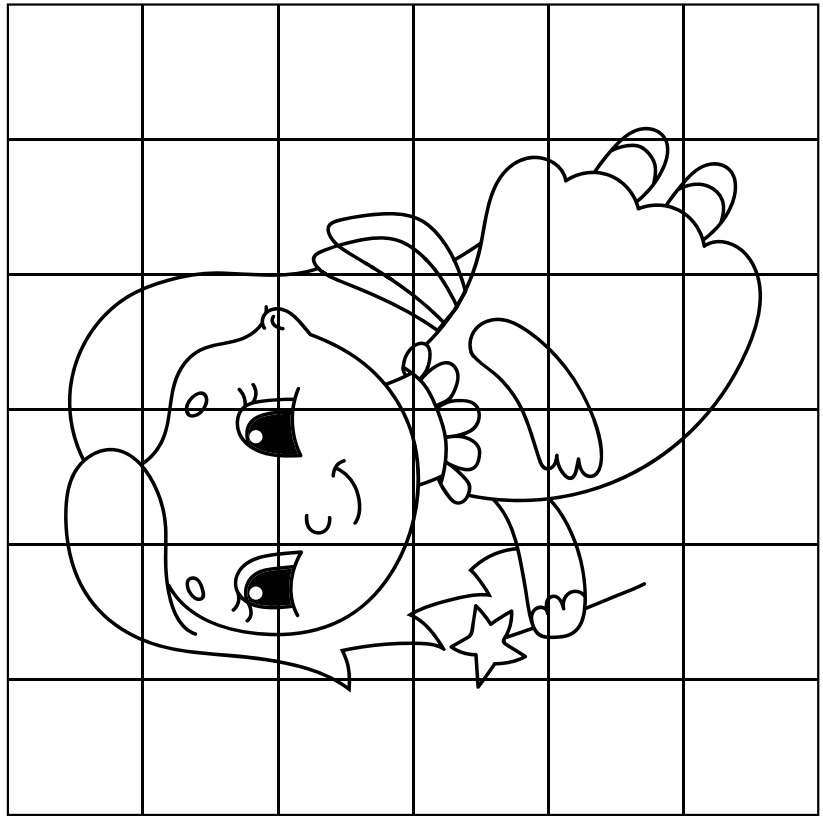
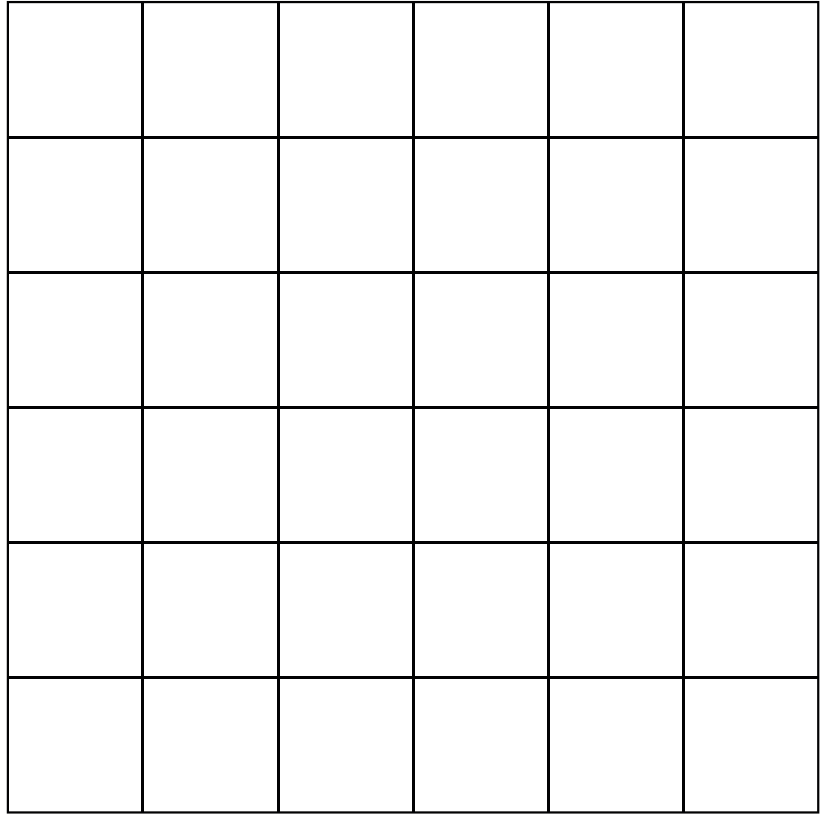
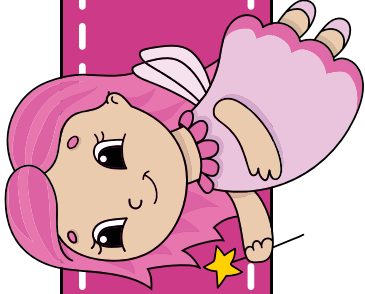

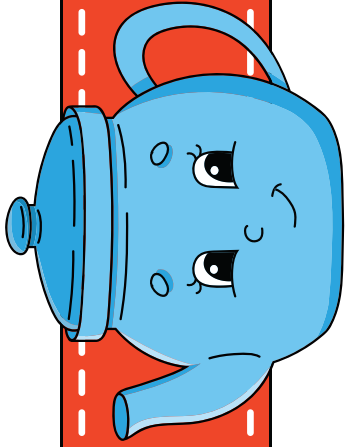

Copy the picture

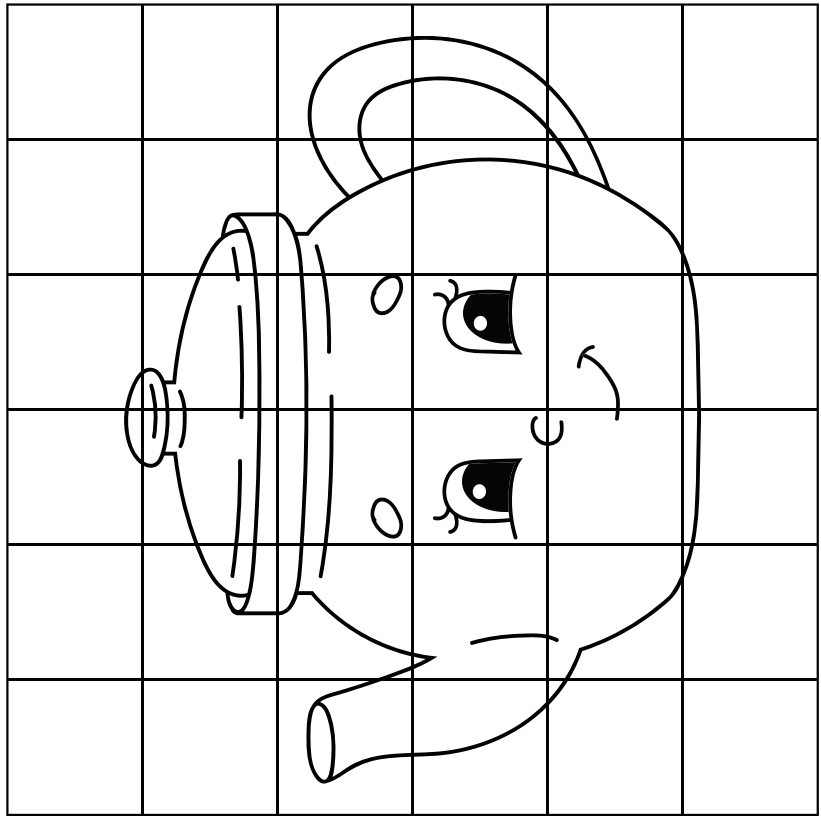
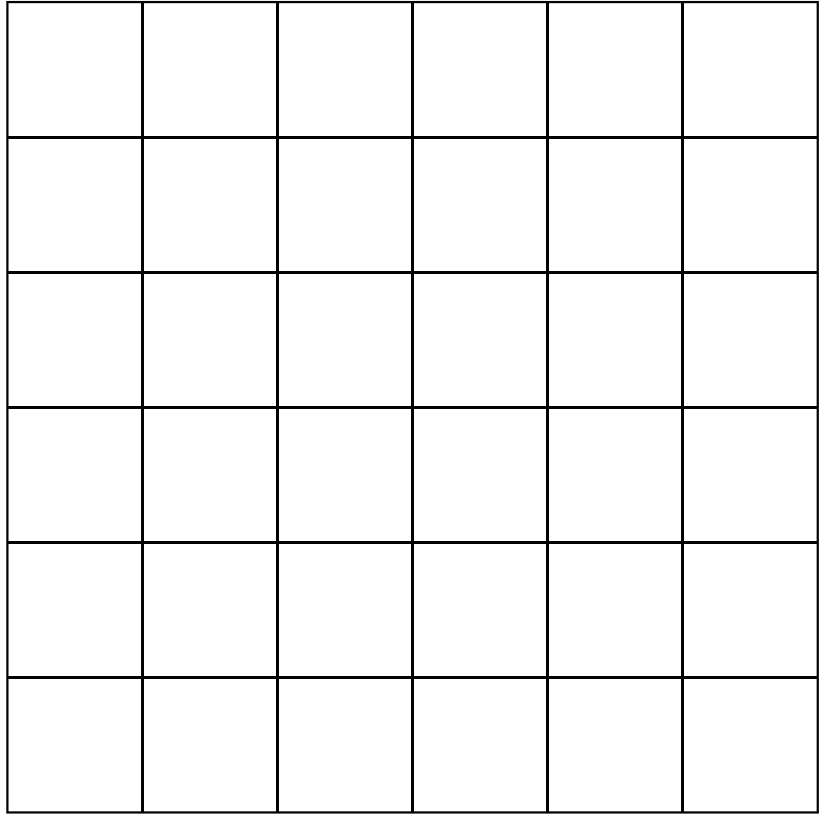

DRAWING

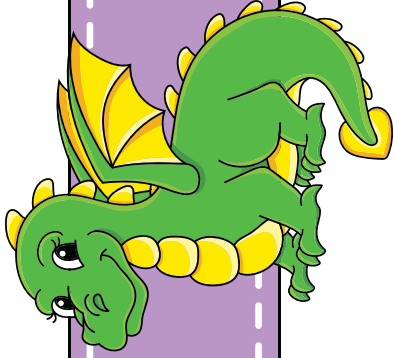

Copy the picture

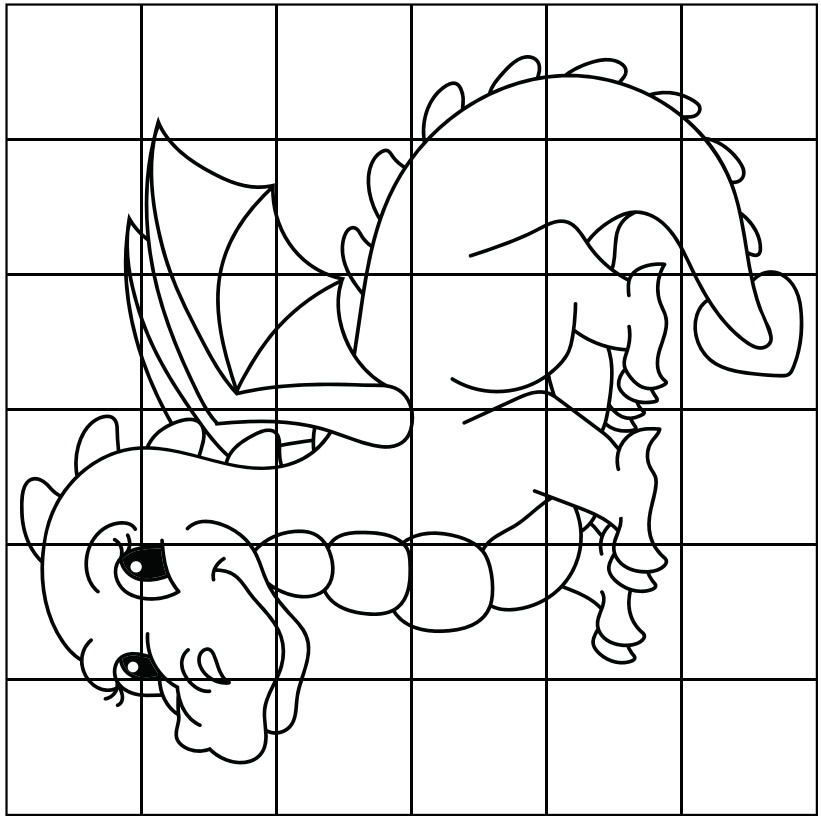
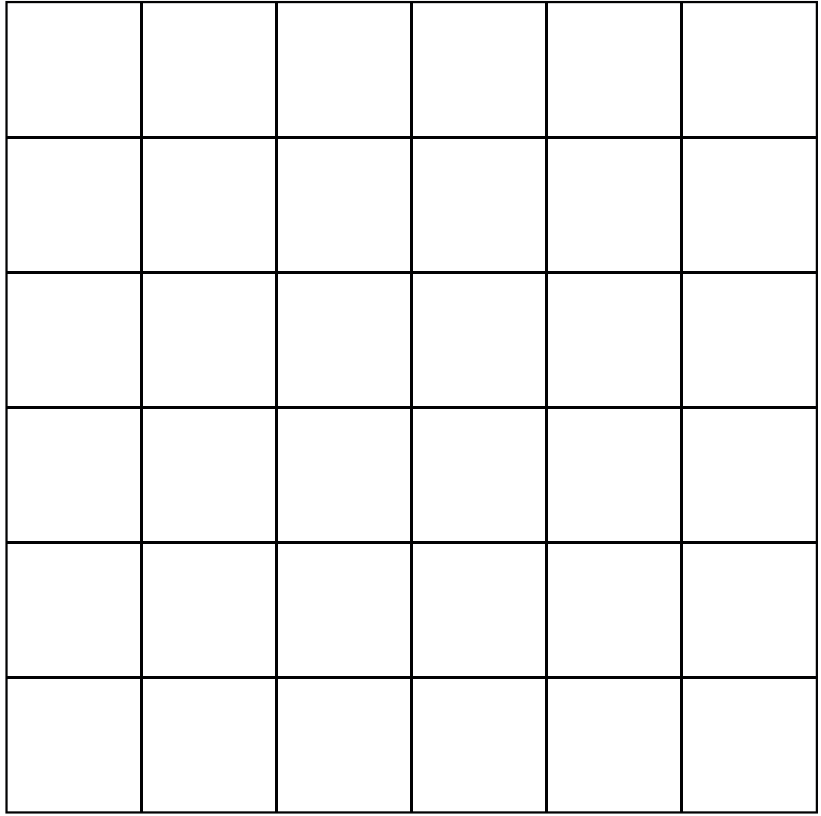

DRAWING

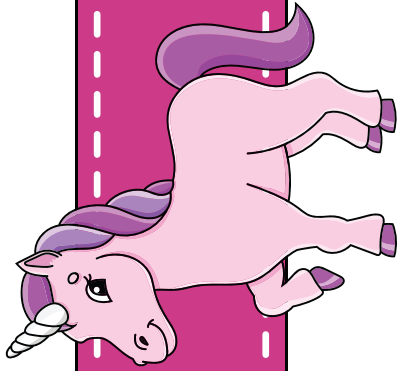

Copy the picture

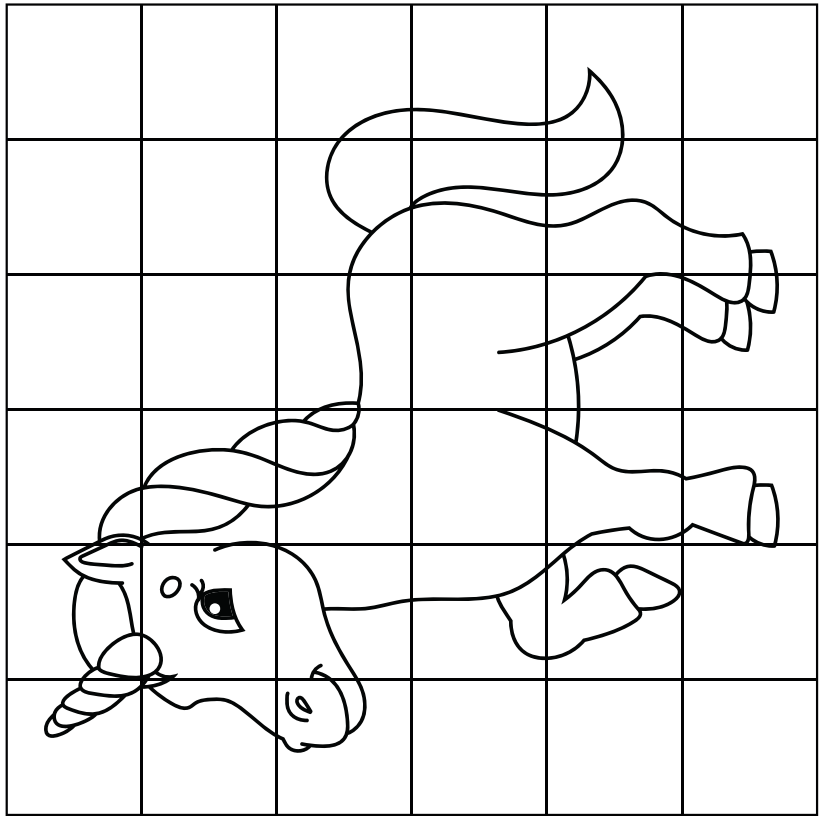
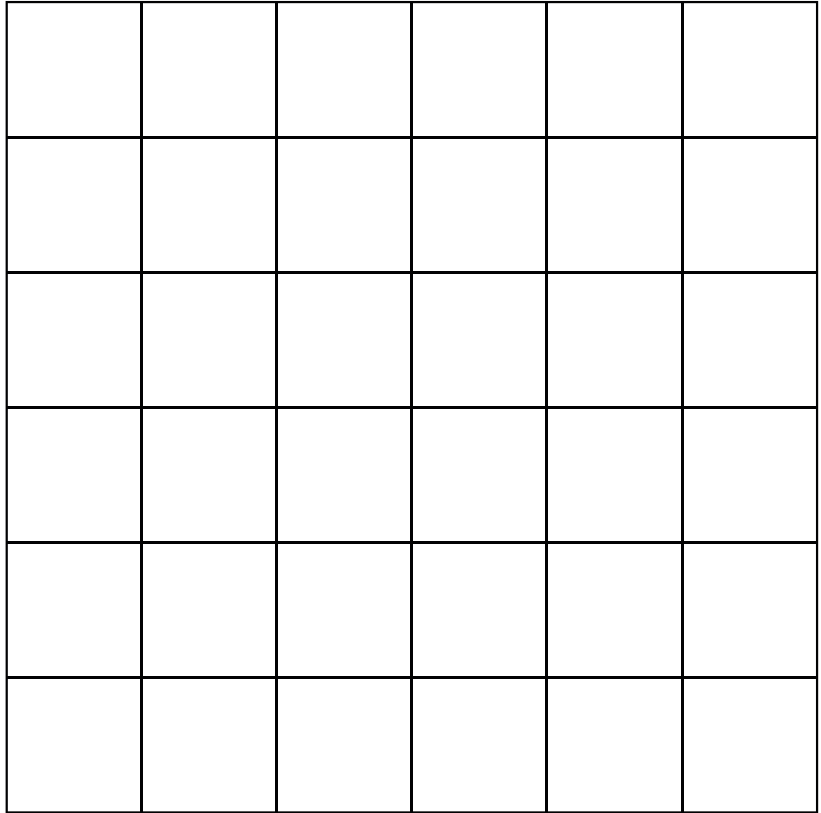

DRAWING

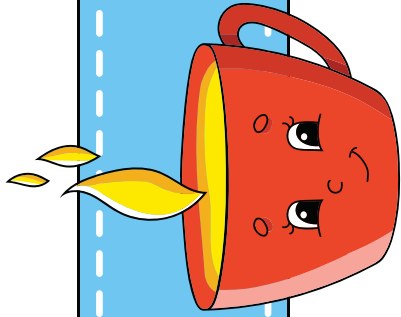

Copy the picture

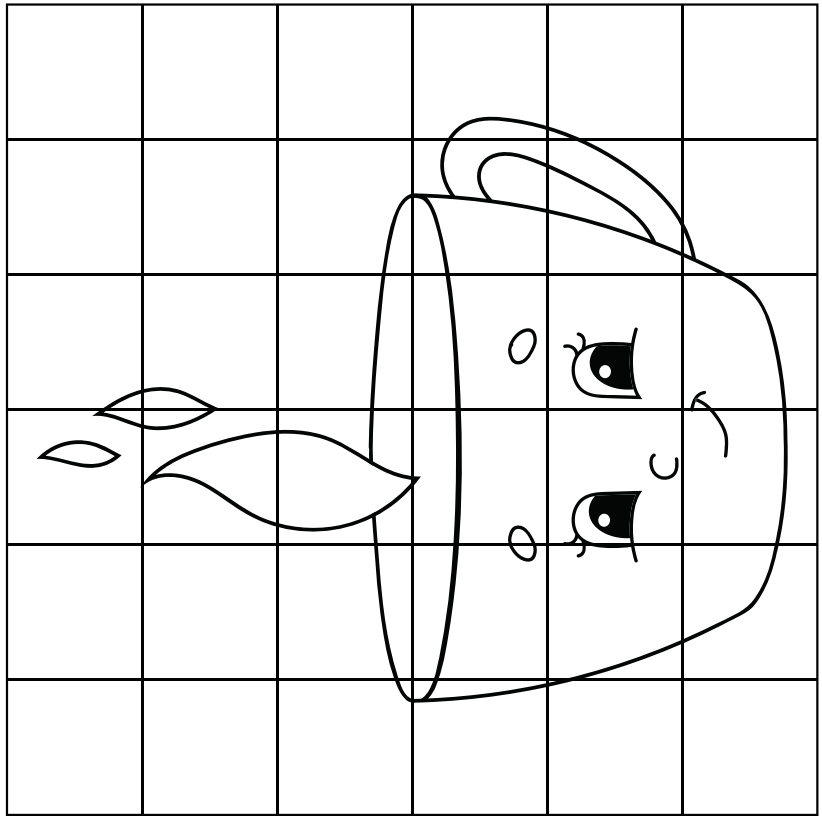
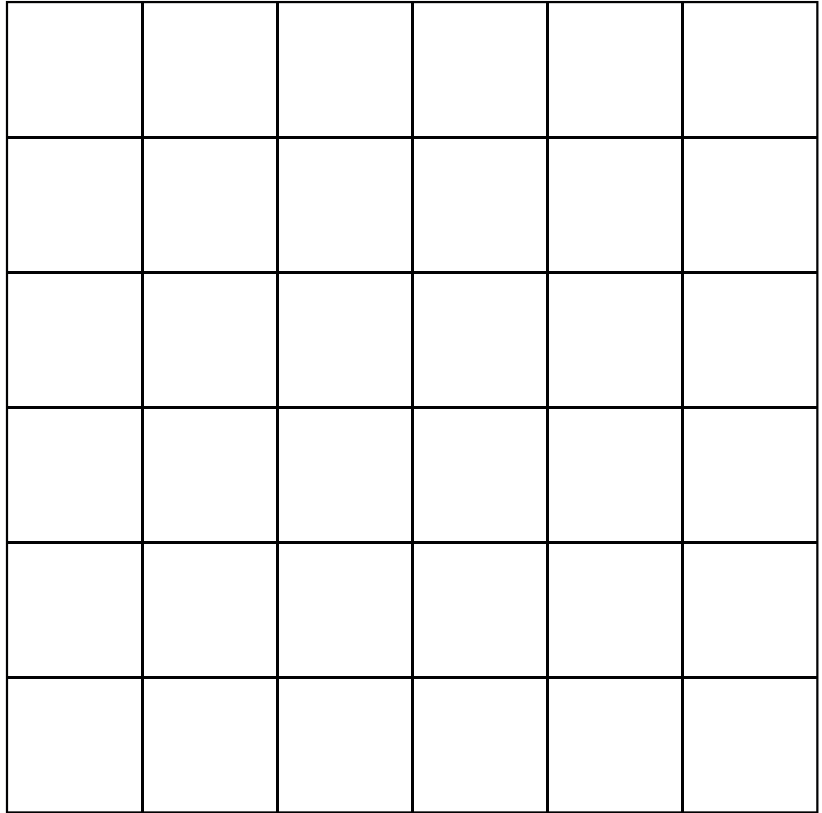

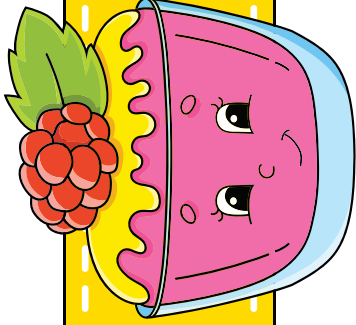

Copy the picture

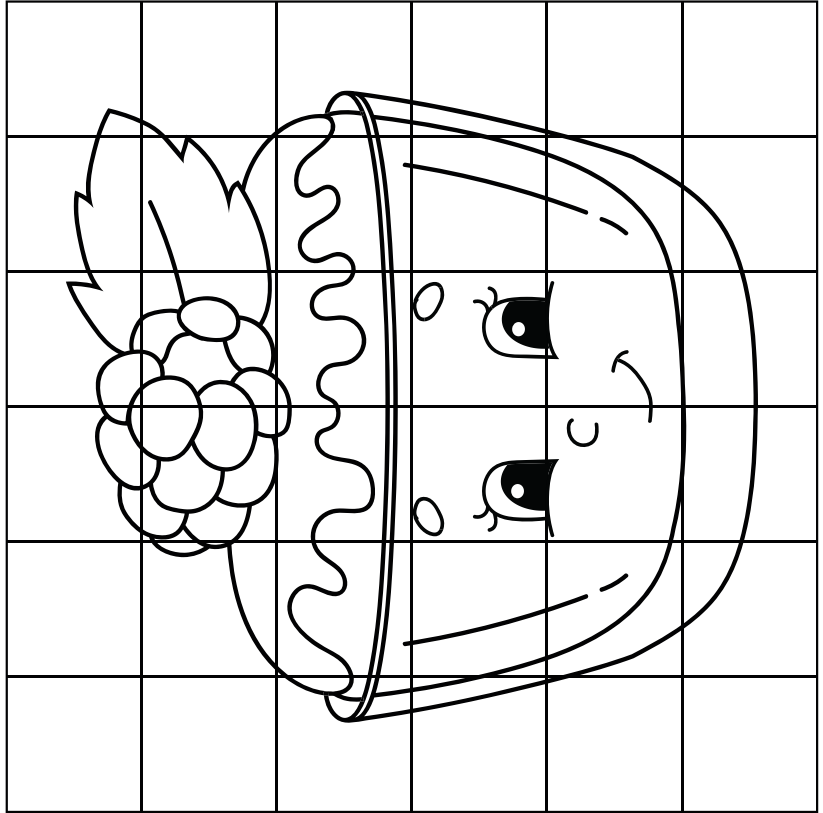
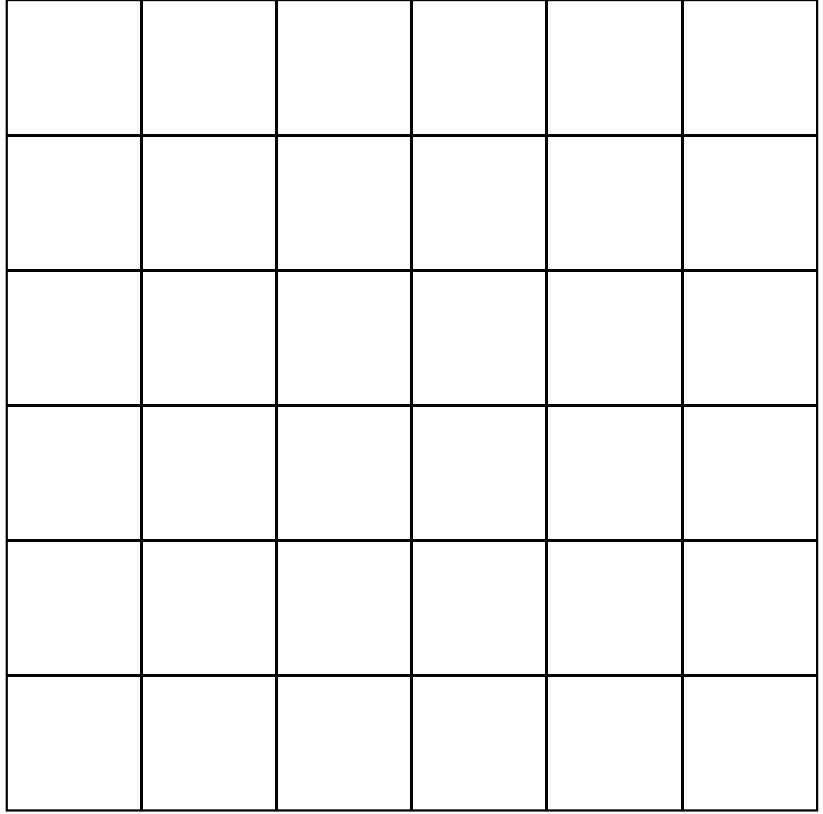

DRAWING

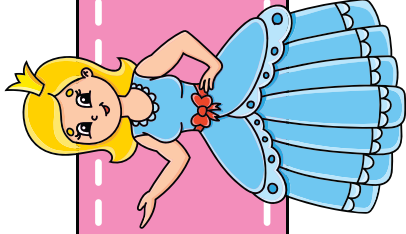

Copy the picture

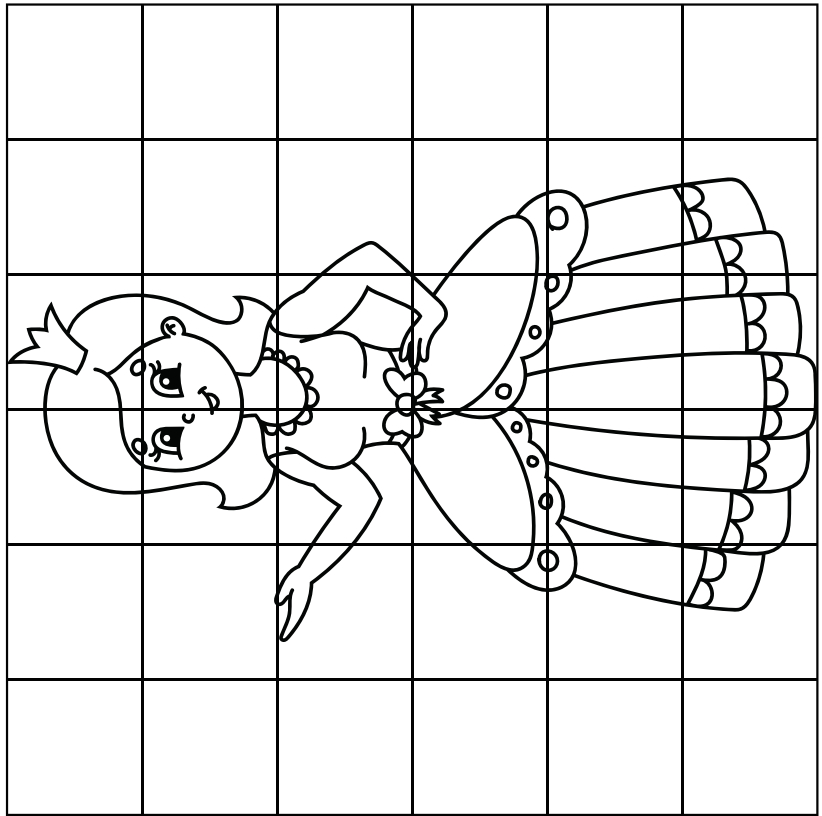
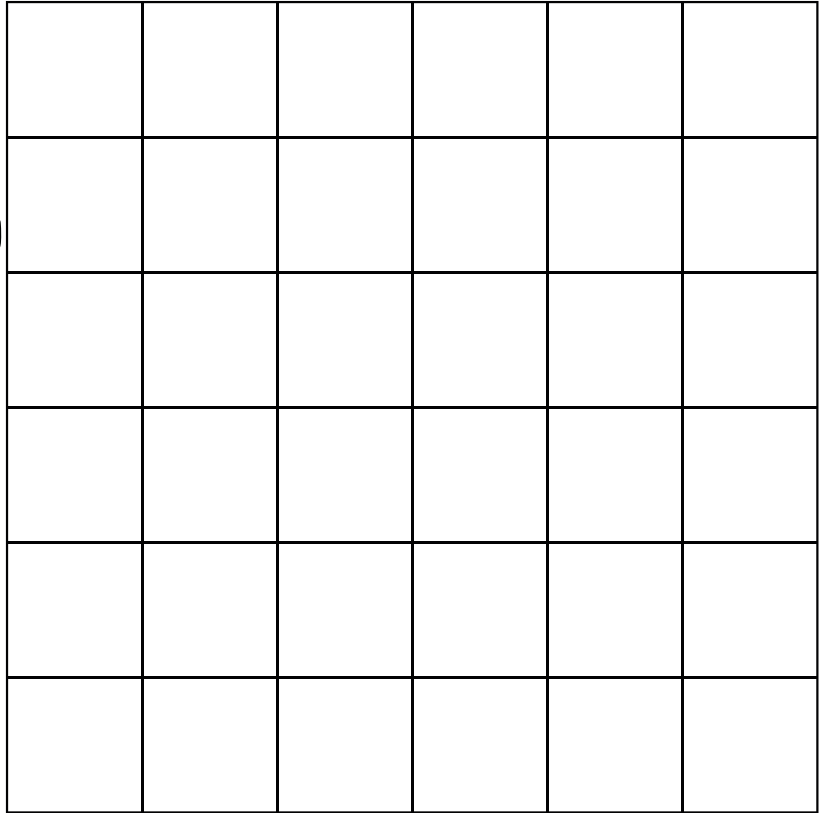

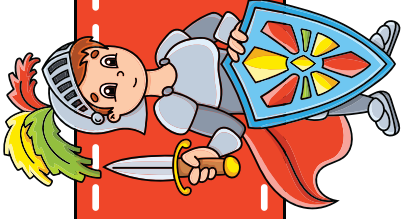

Copy the picture

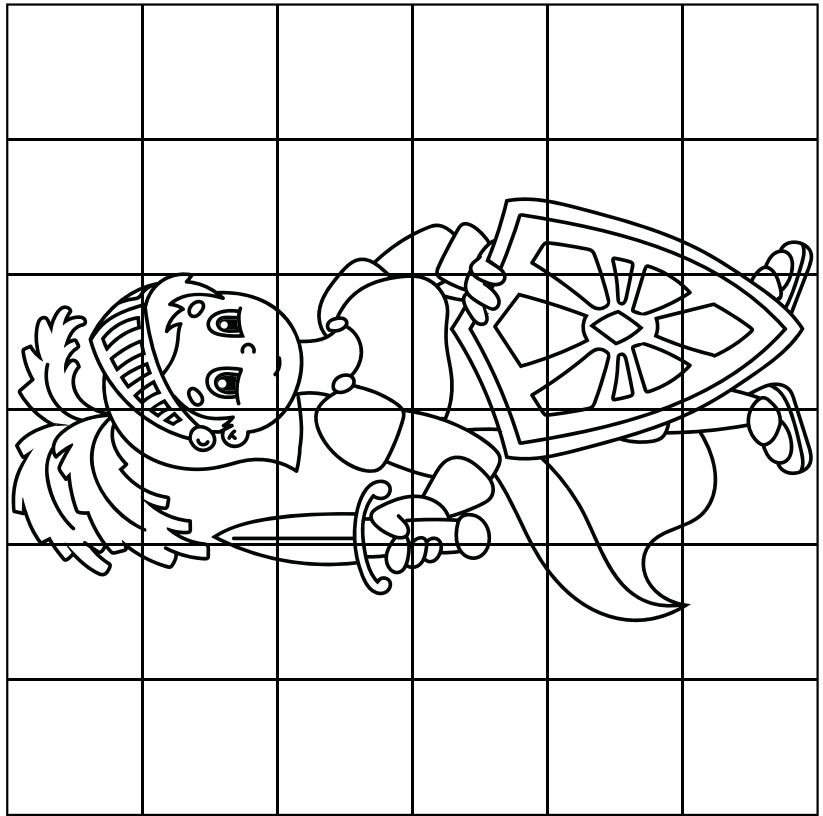
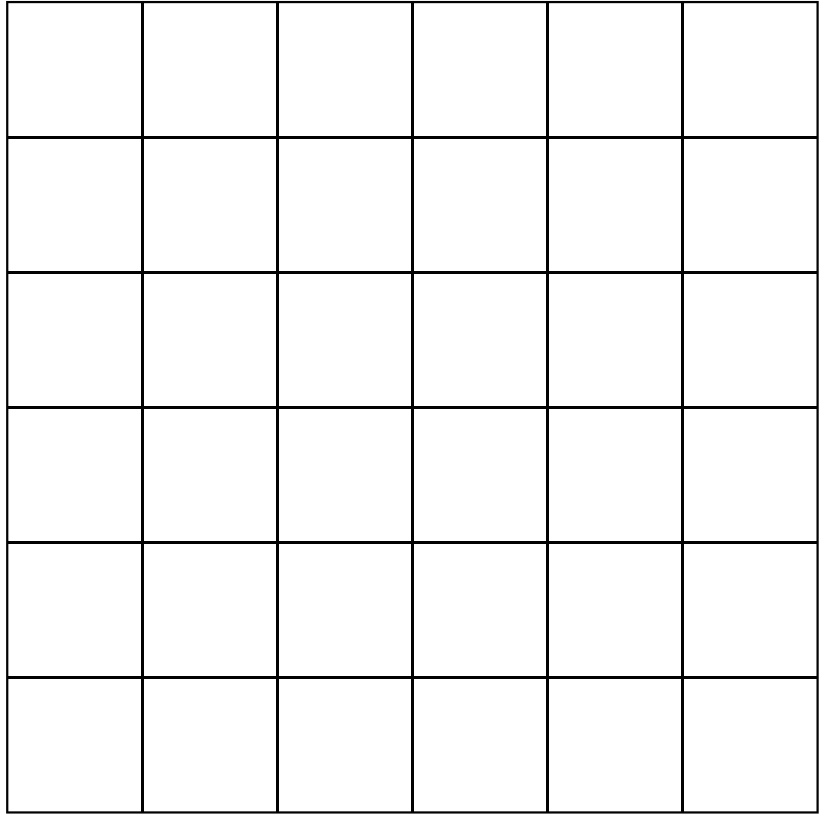

DRAWING

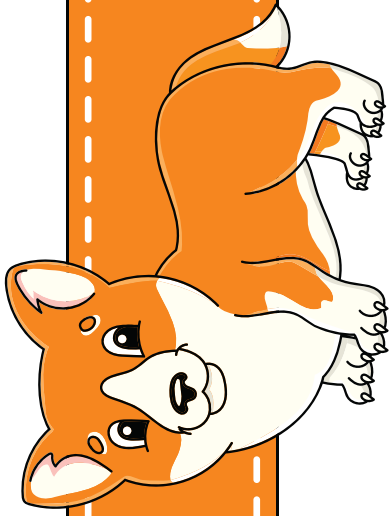

Copy the picture

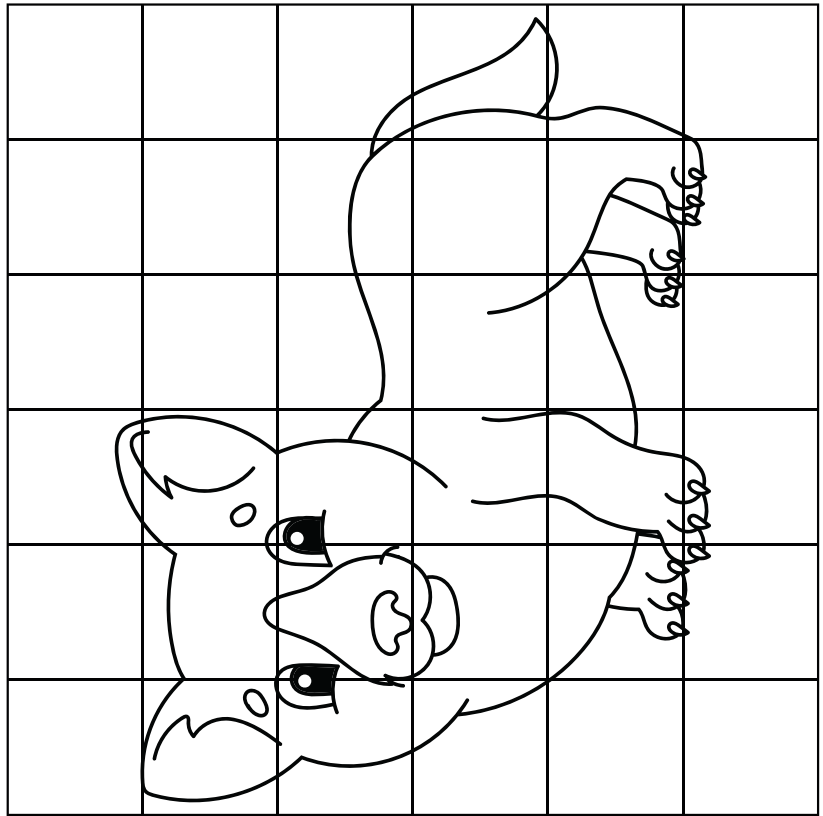
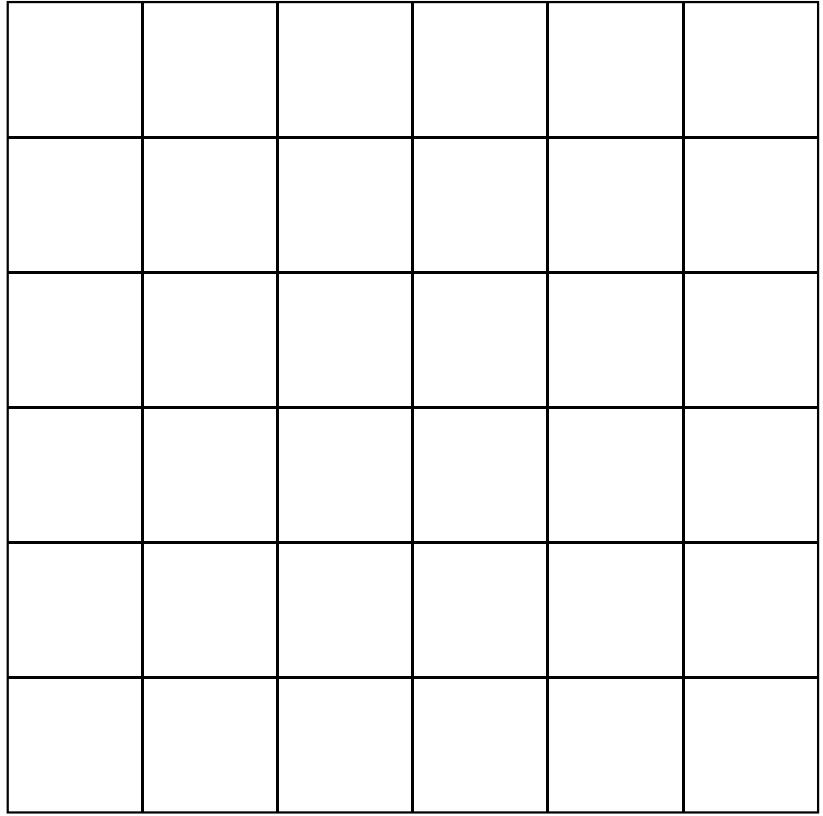

DRAWING

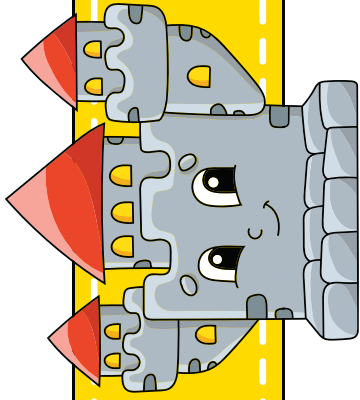

Copy the picture

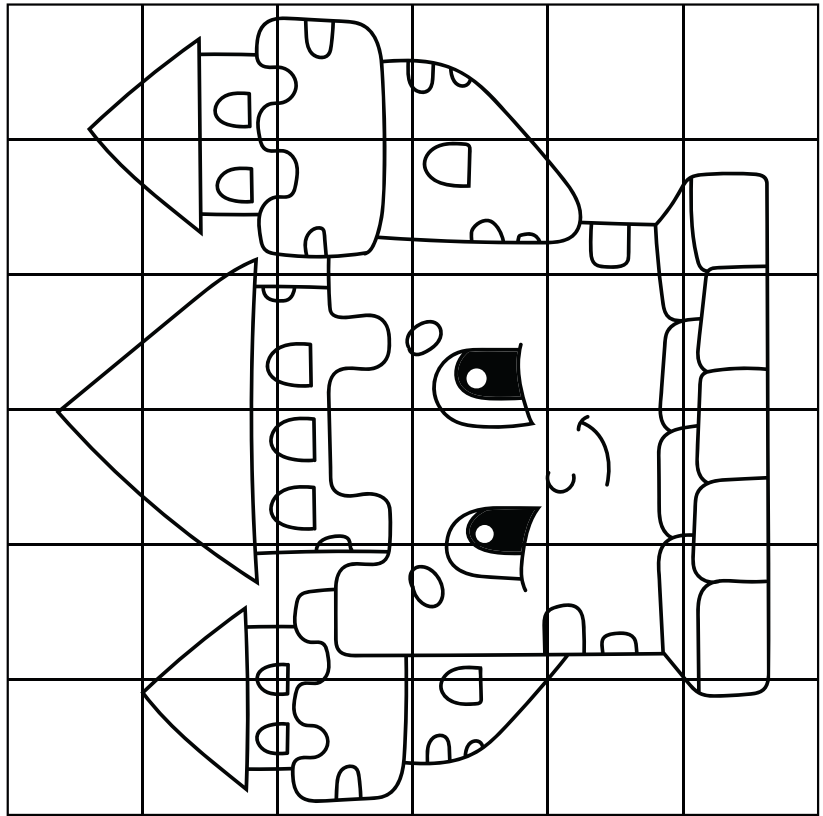
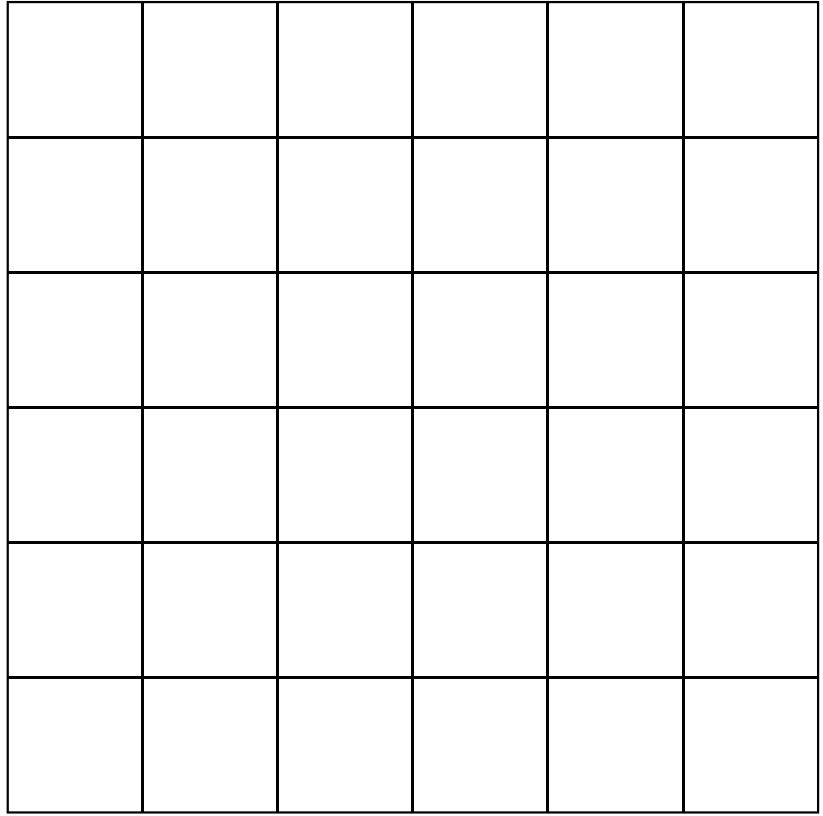

DRAWING

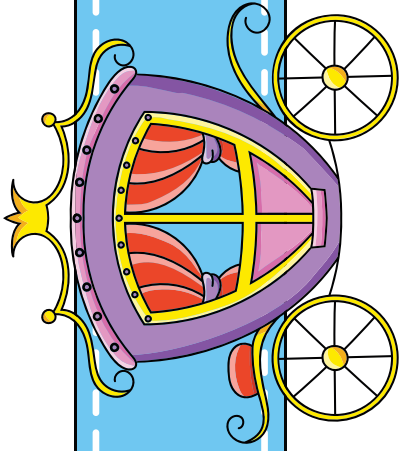

Copy the picture

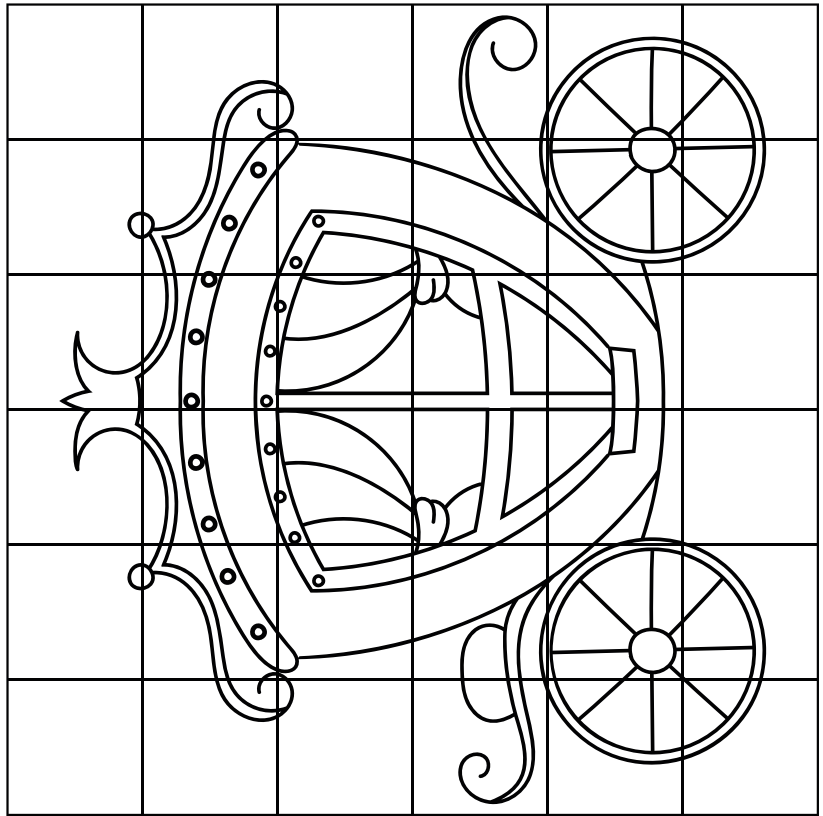
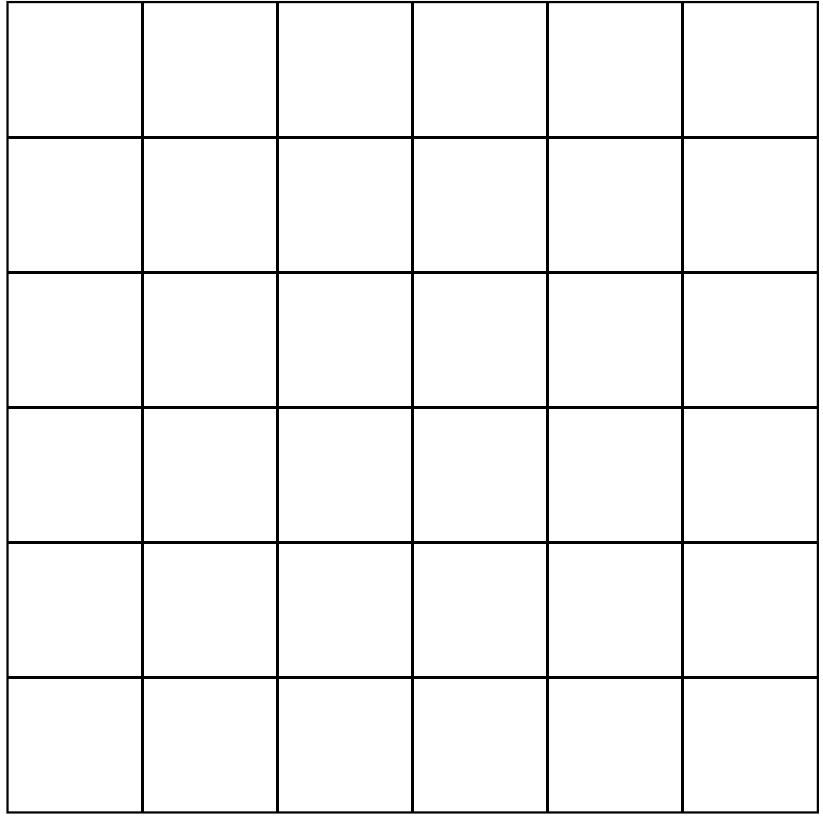

DRAWING

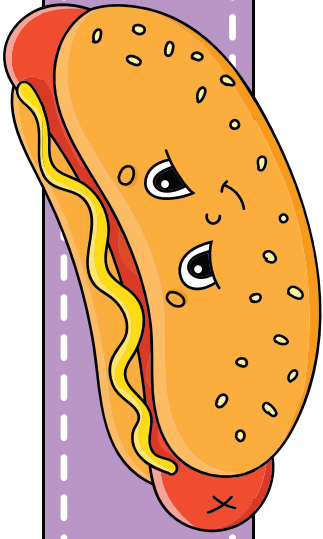

Copy the picture

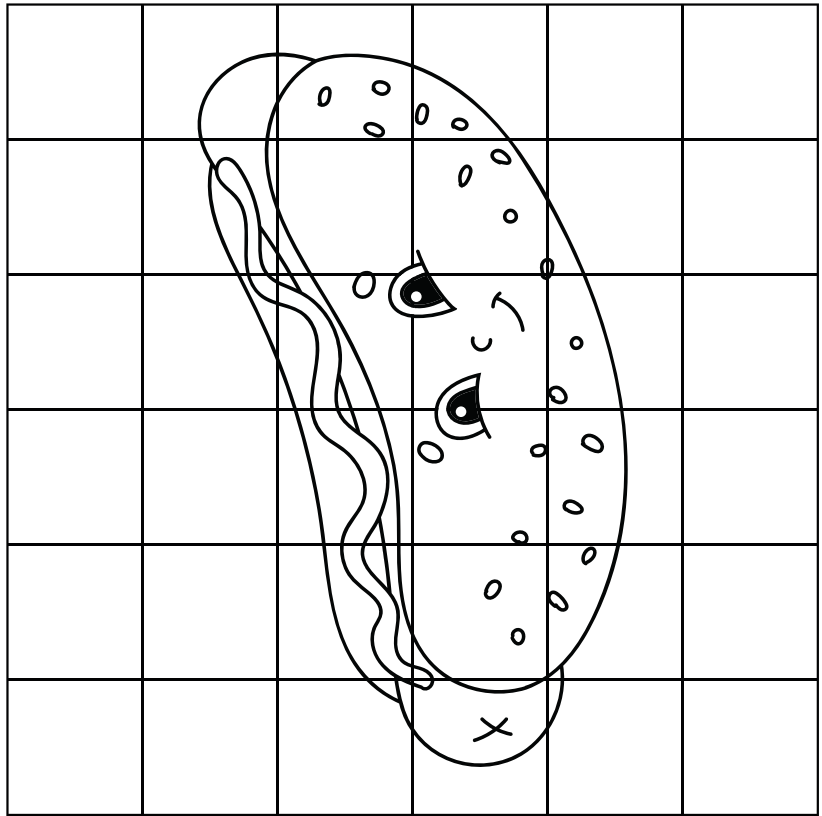
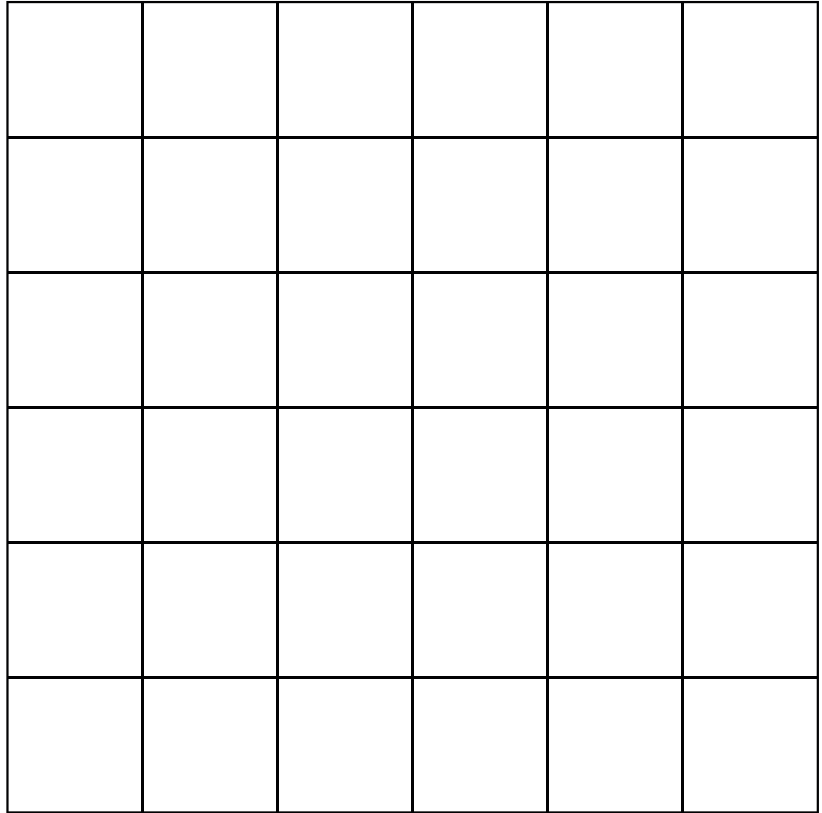

DRAWING

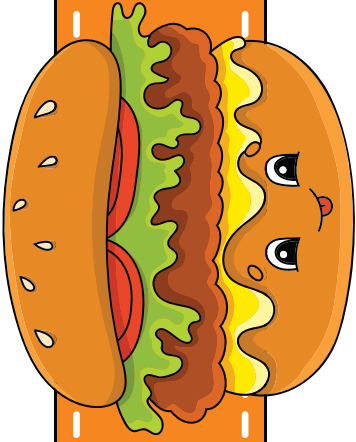

Copy the picture

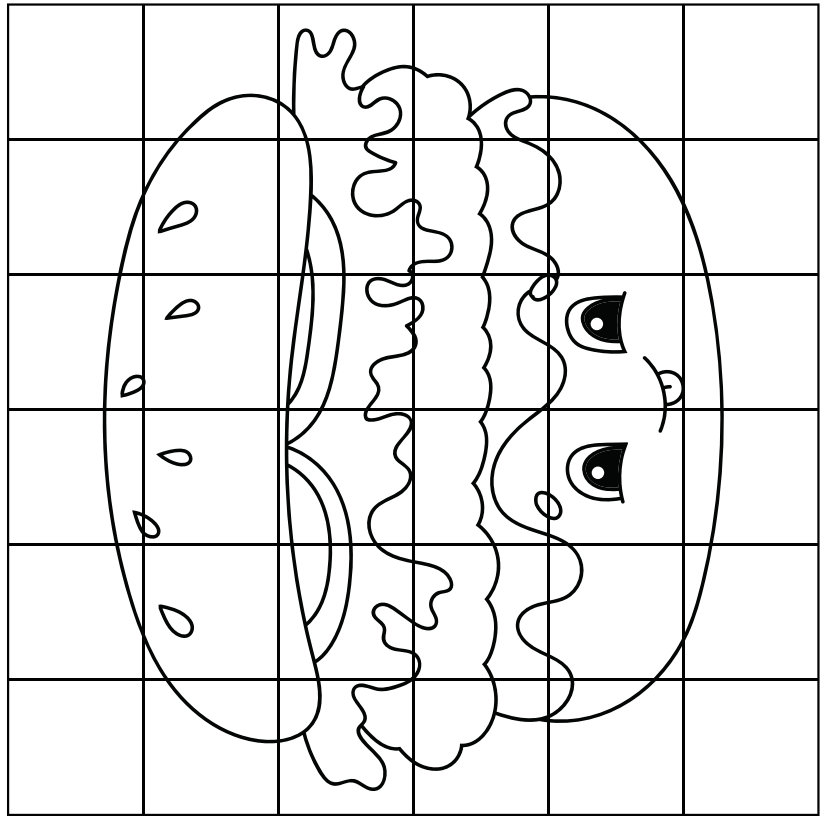
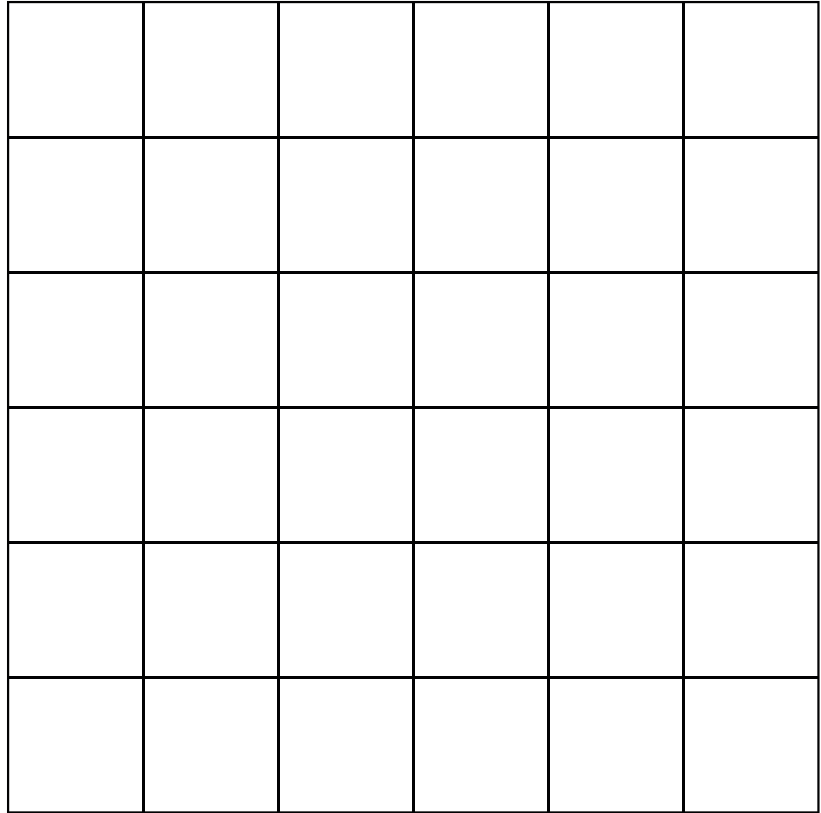

DRAWING

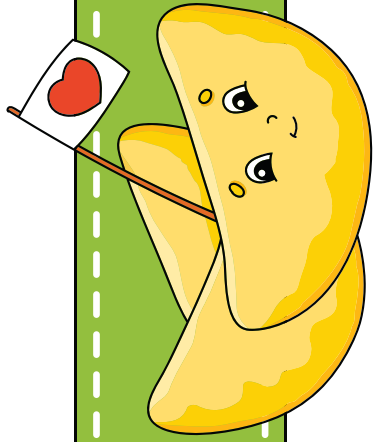

Copy the picture

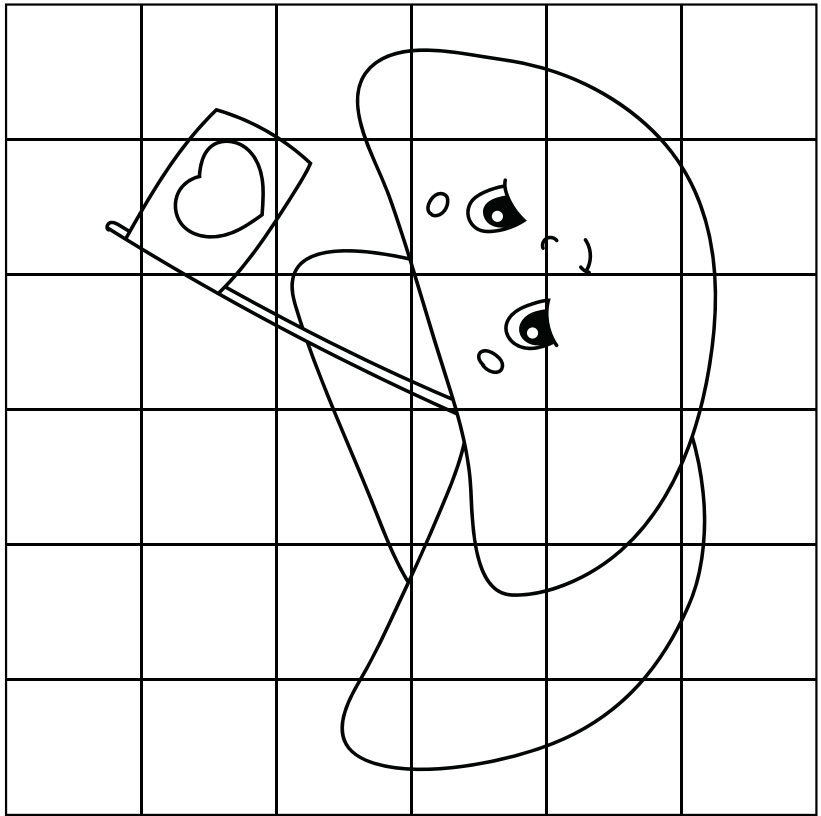
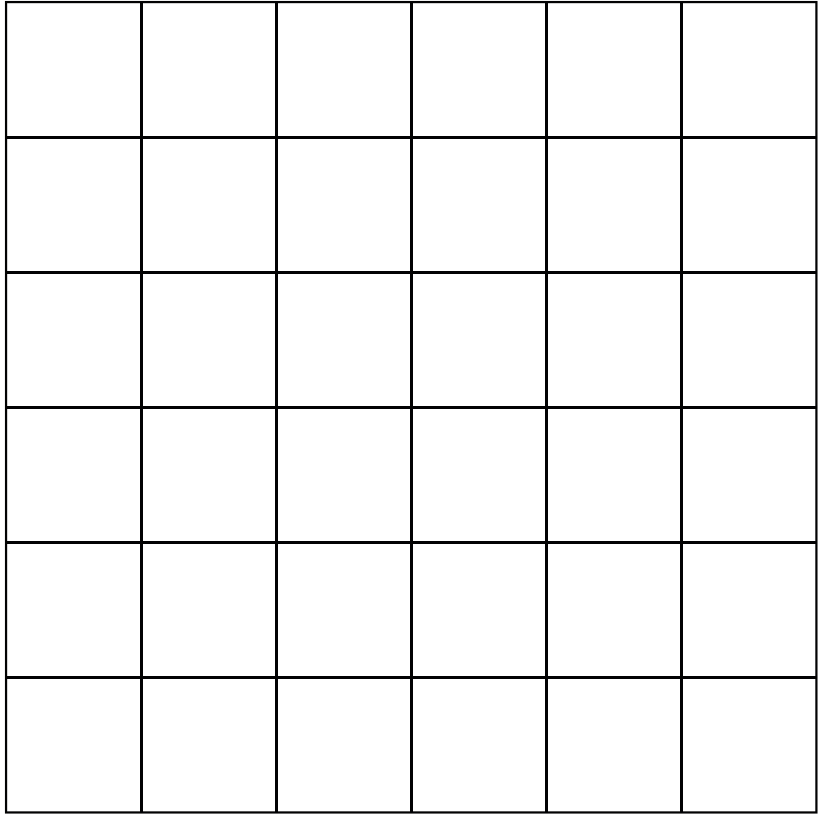

Copy the picture

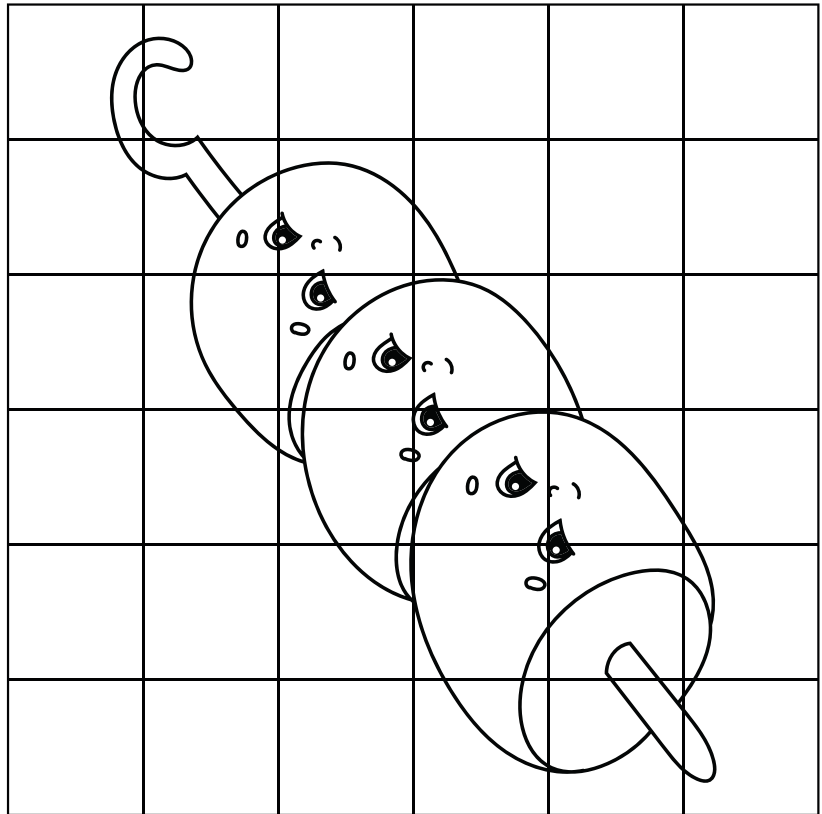
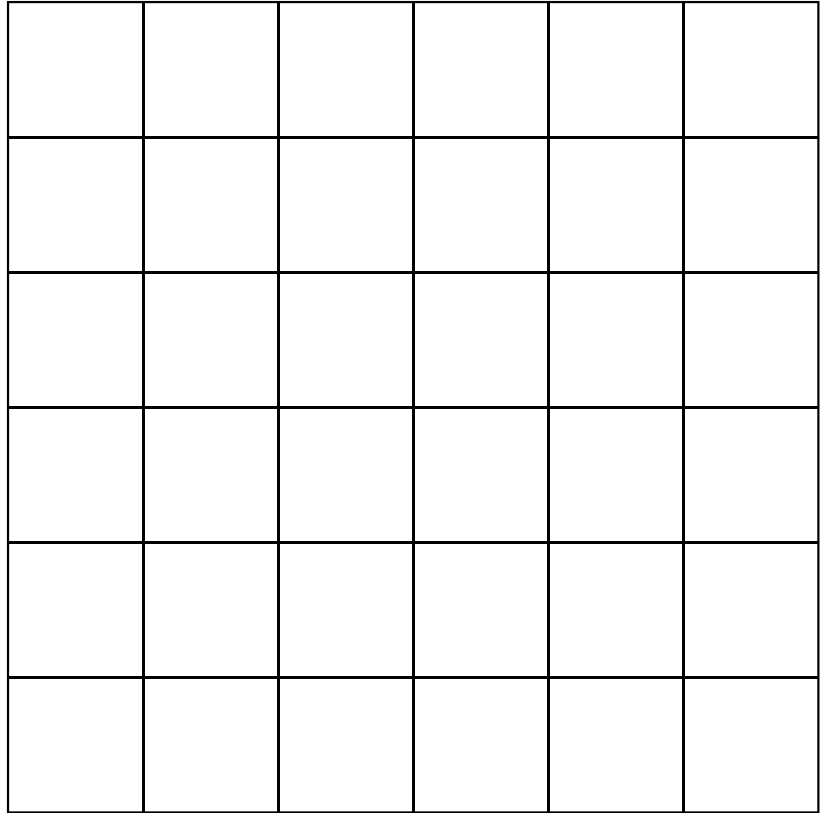
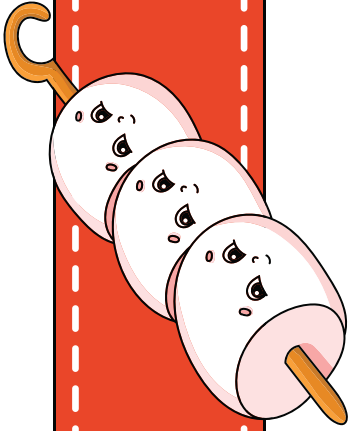

DRAWING

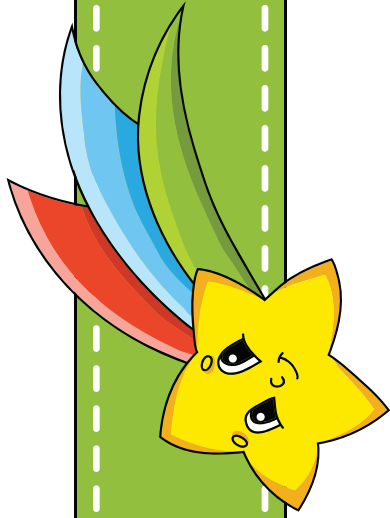

Copy the picture

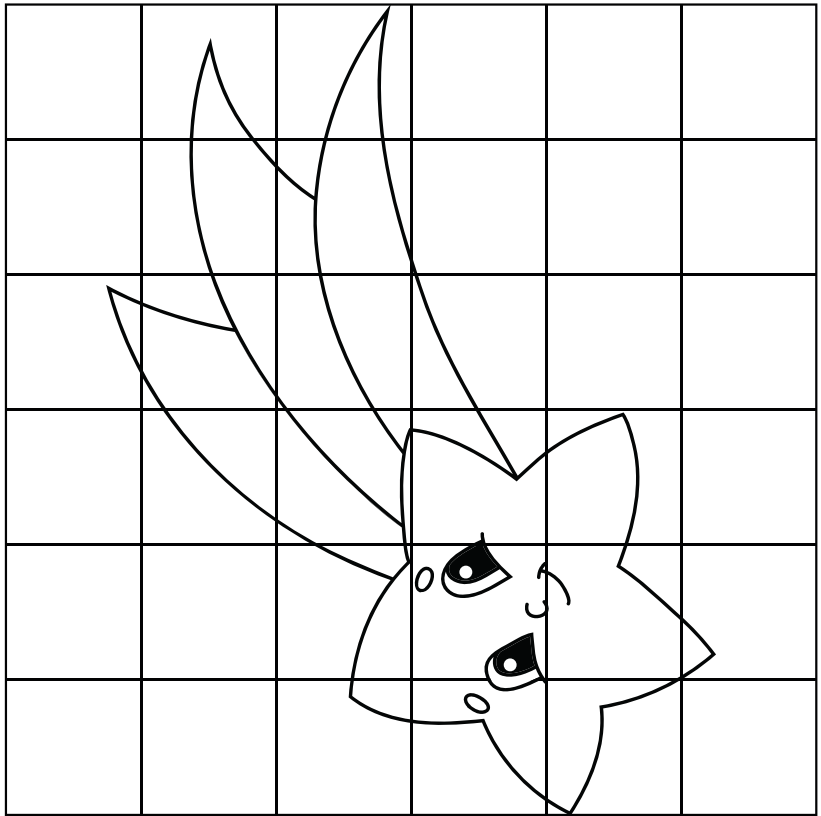
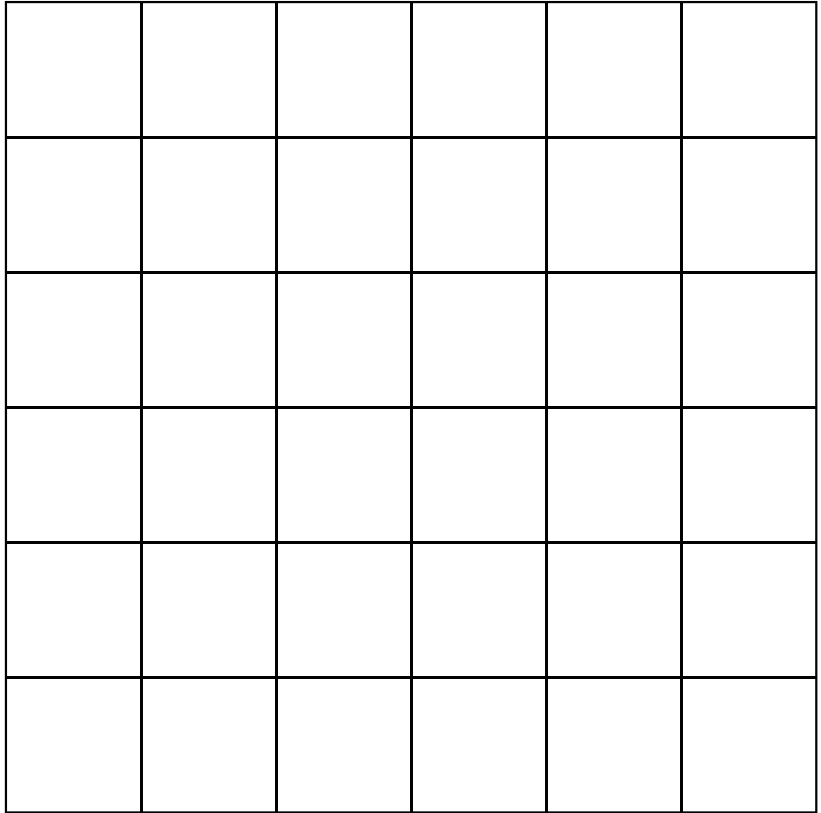

Finish the picture

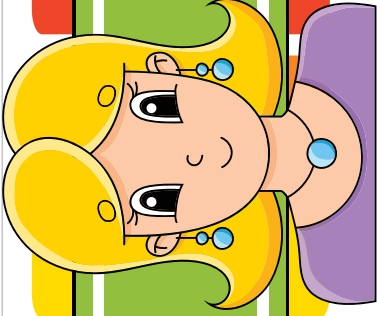

a b c d

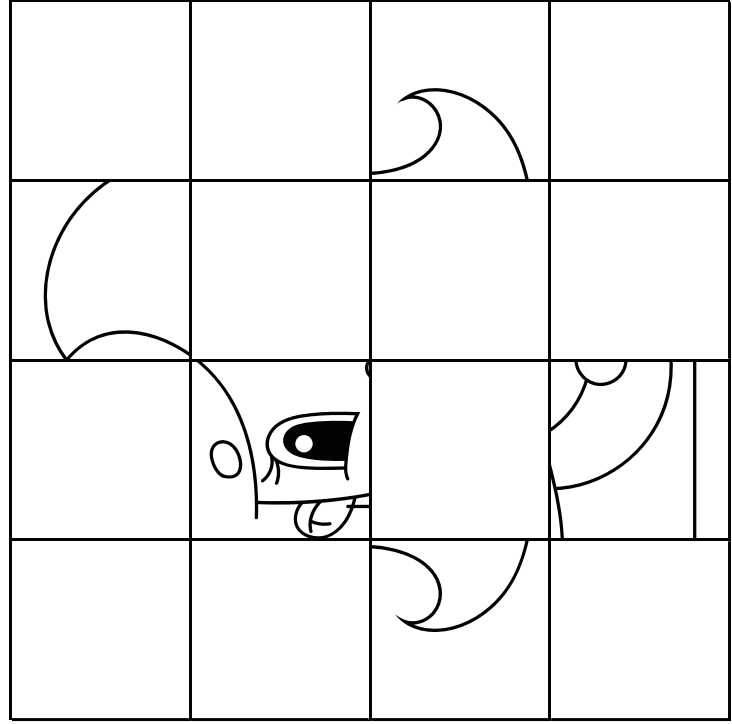

a b c d

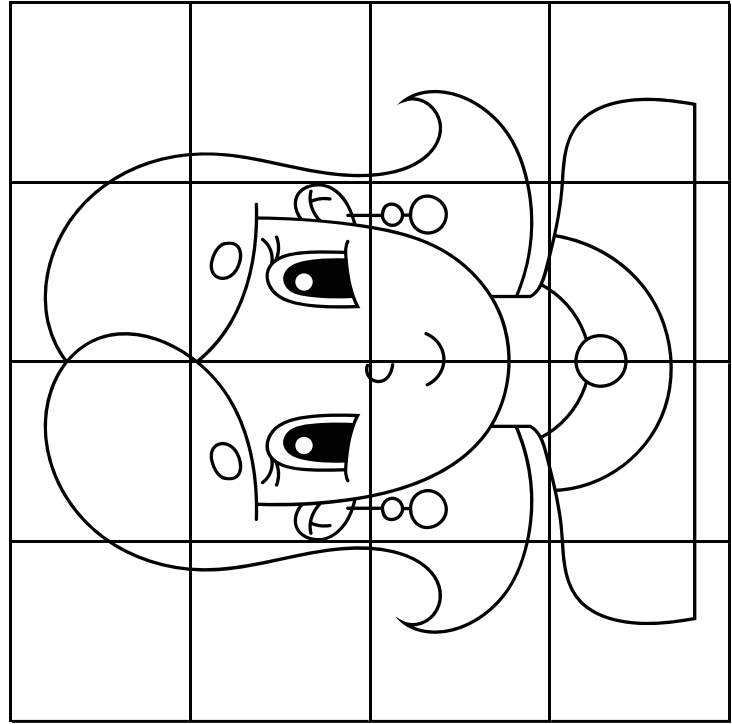

Finish the picture

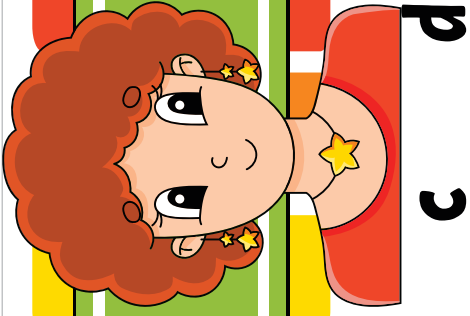

a b c d

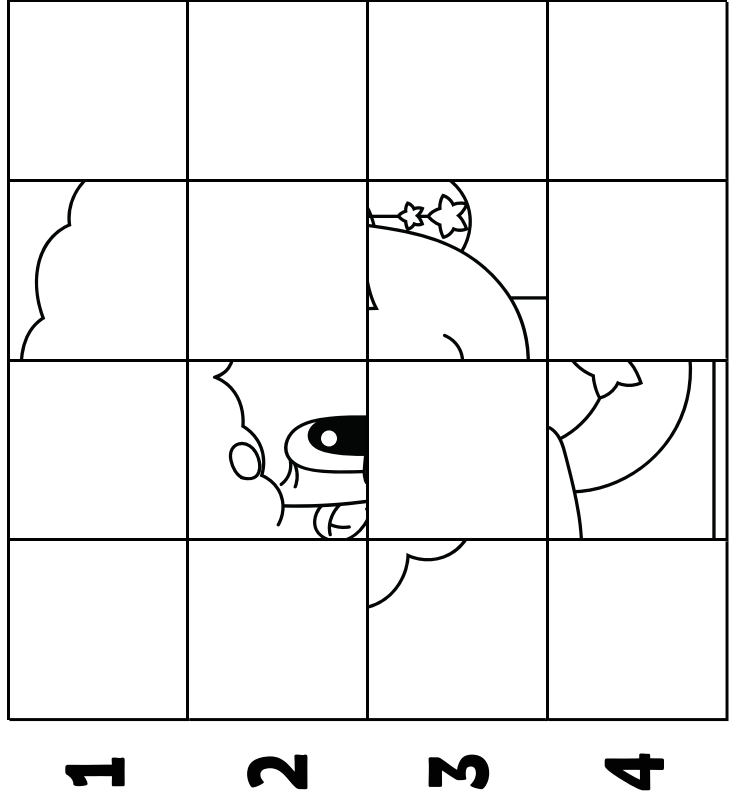

a b c d

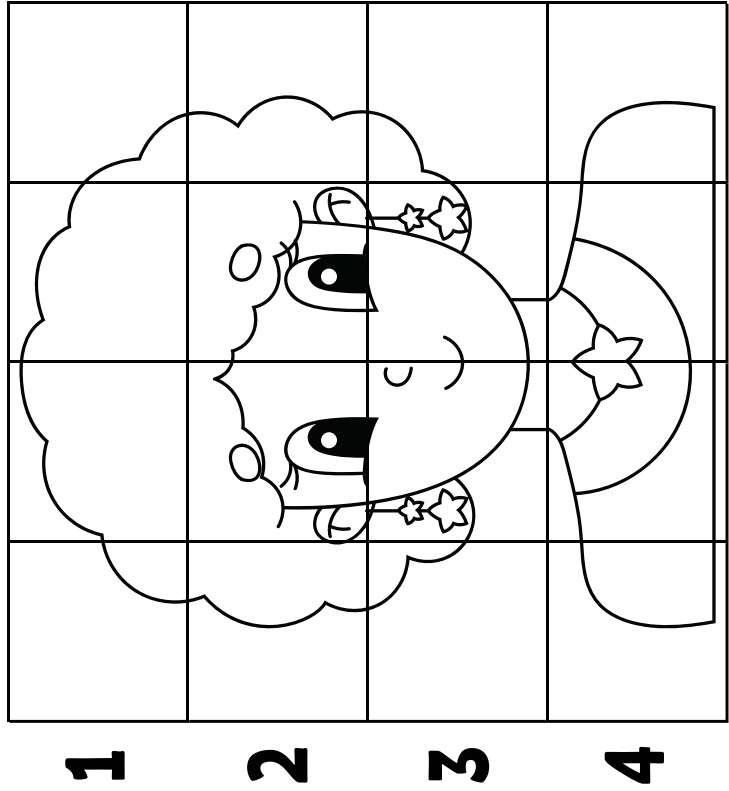

Finish the picture

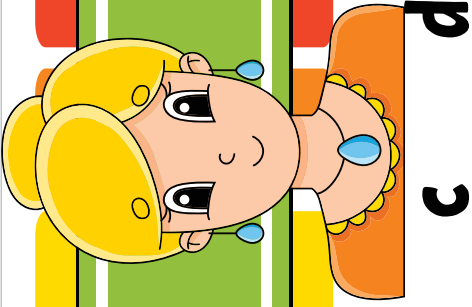

a b c d

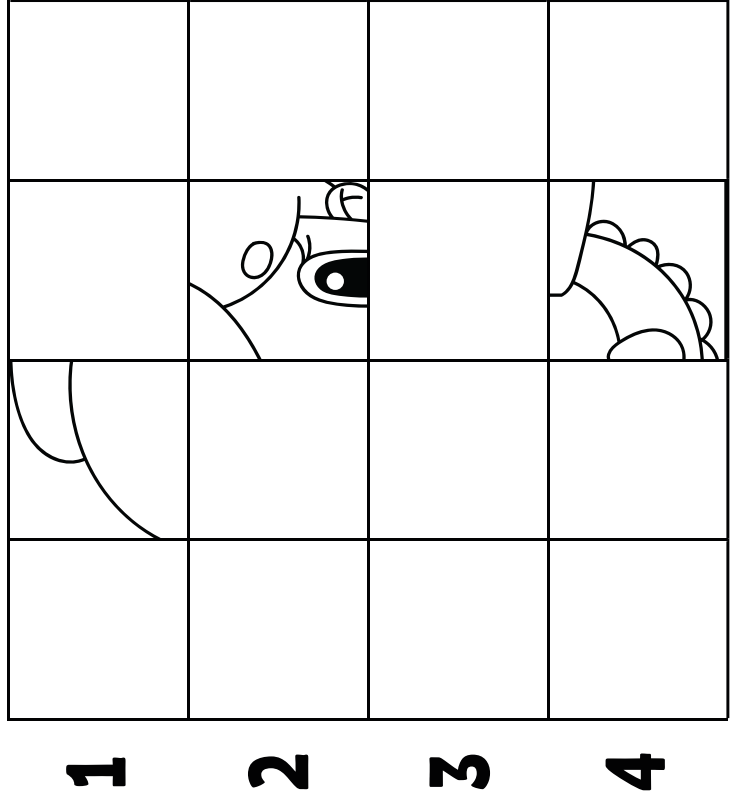

a b c d

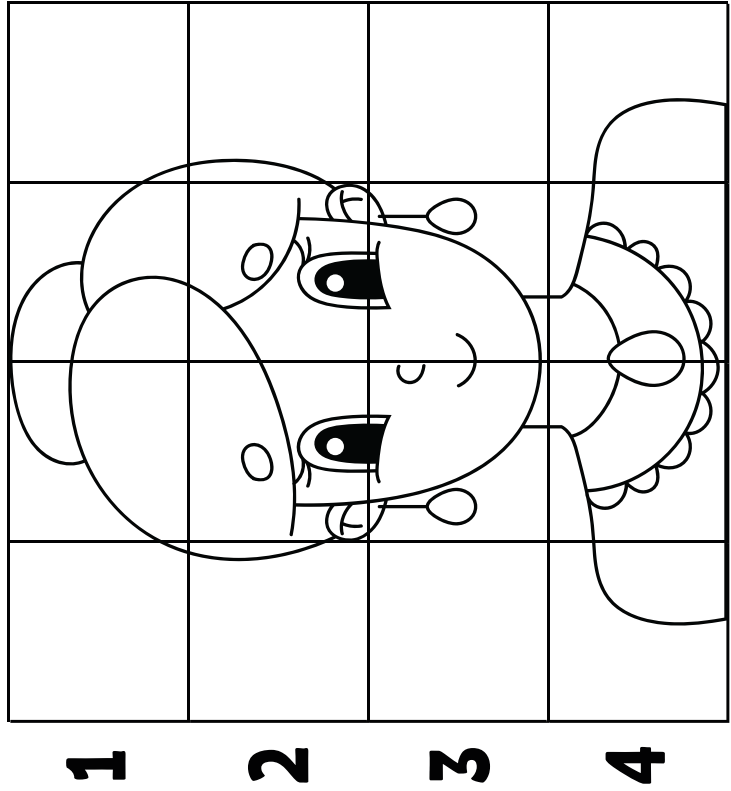

Finish the picture

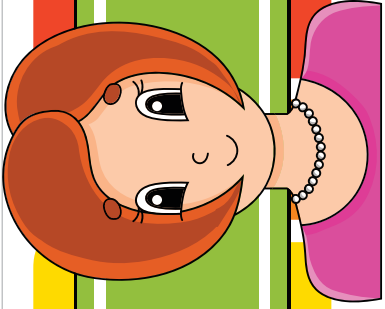

a b c d

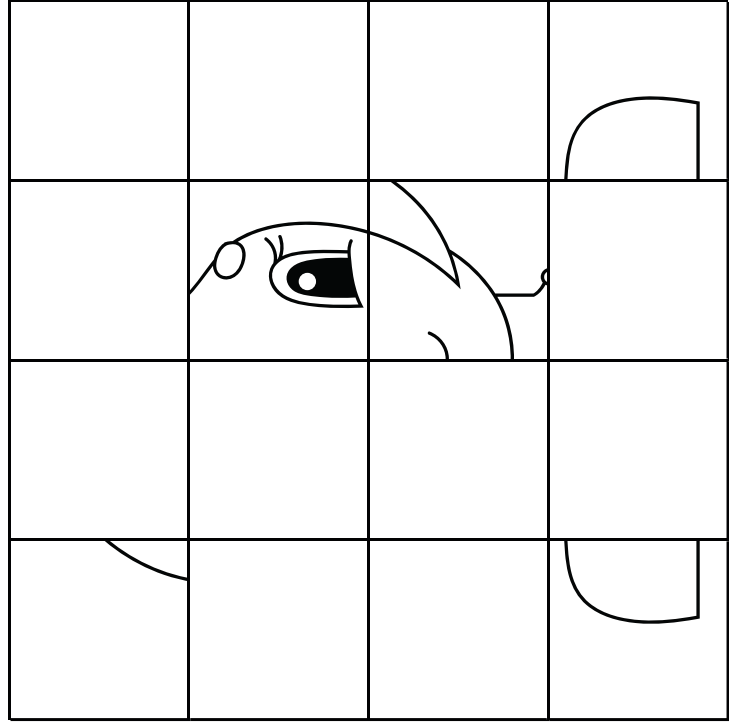

1 2 3 4

a b c d

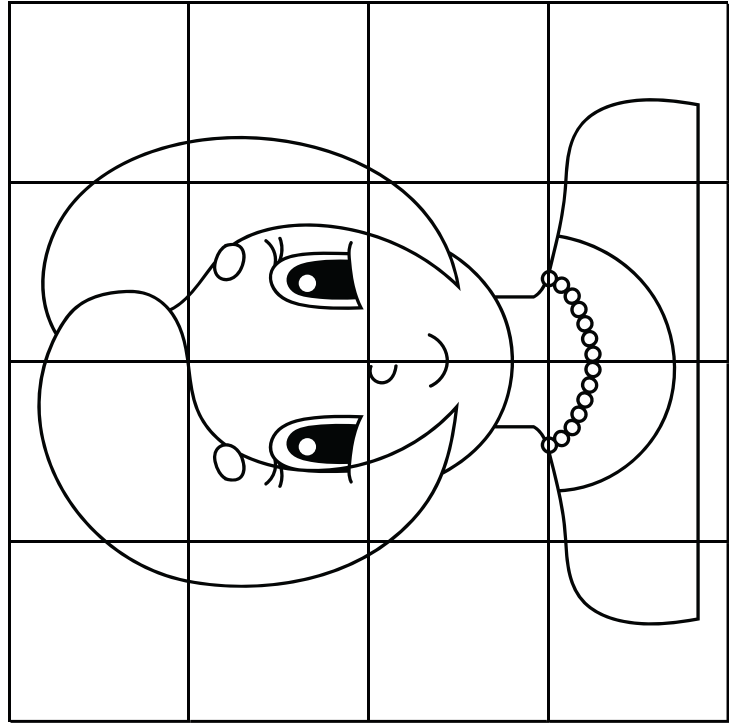

1 2 3 4

Finish the picture

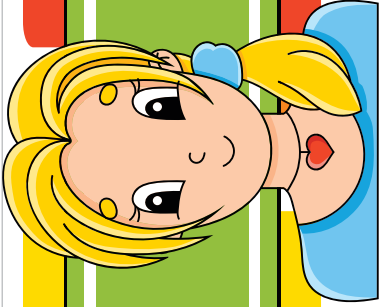

a b c d

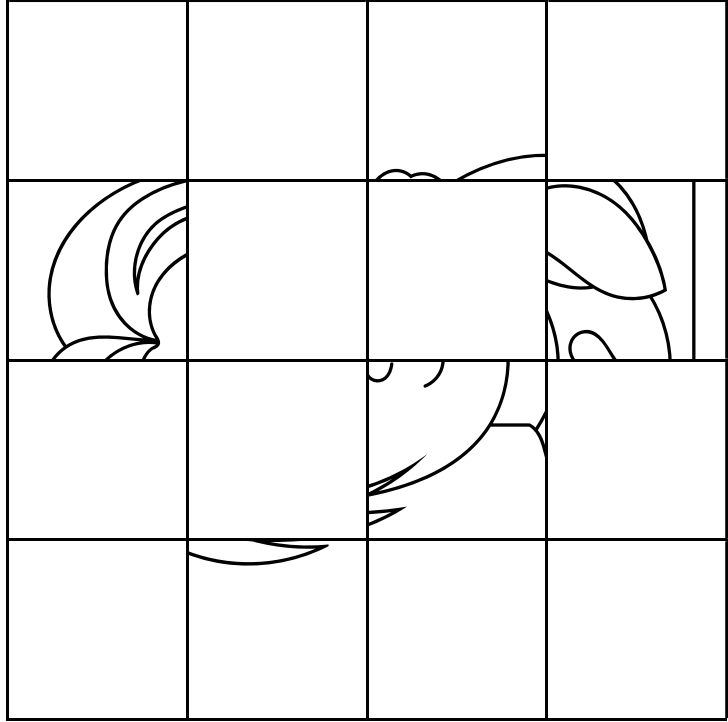

1 2 3 4

a b c d

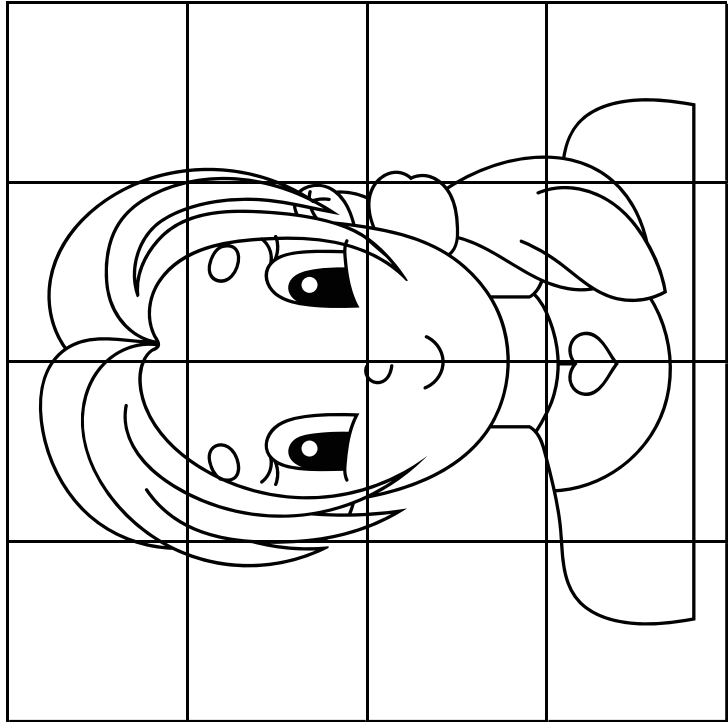

1 2 3 4

DRAWING

4
3
2
1

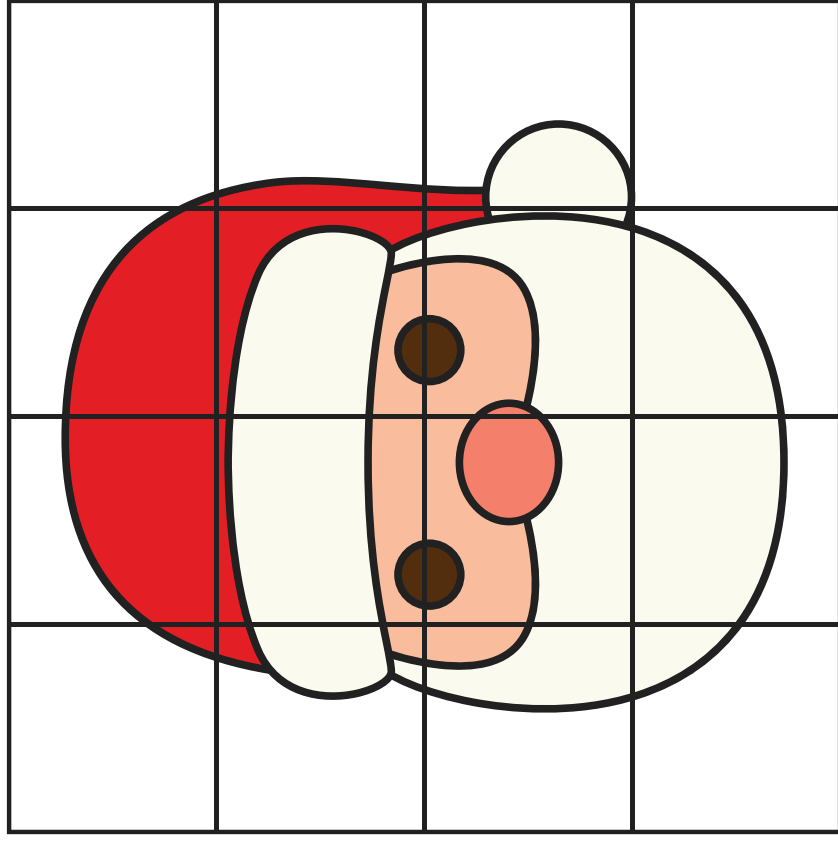

A B C D

4
3
2
1

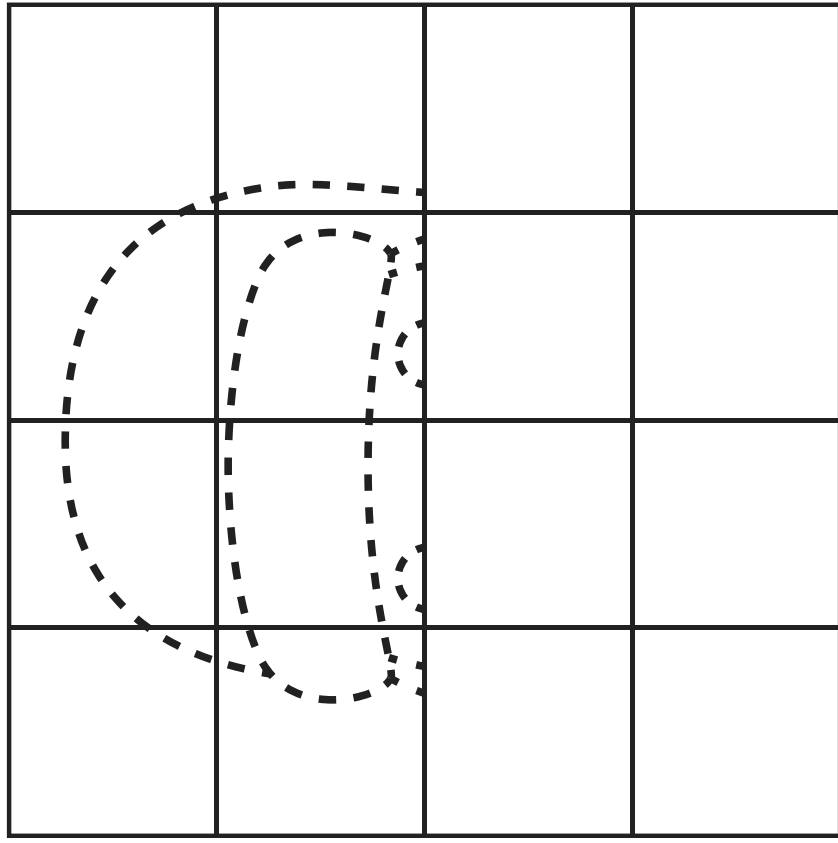

A B C D

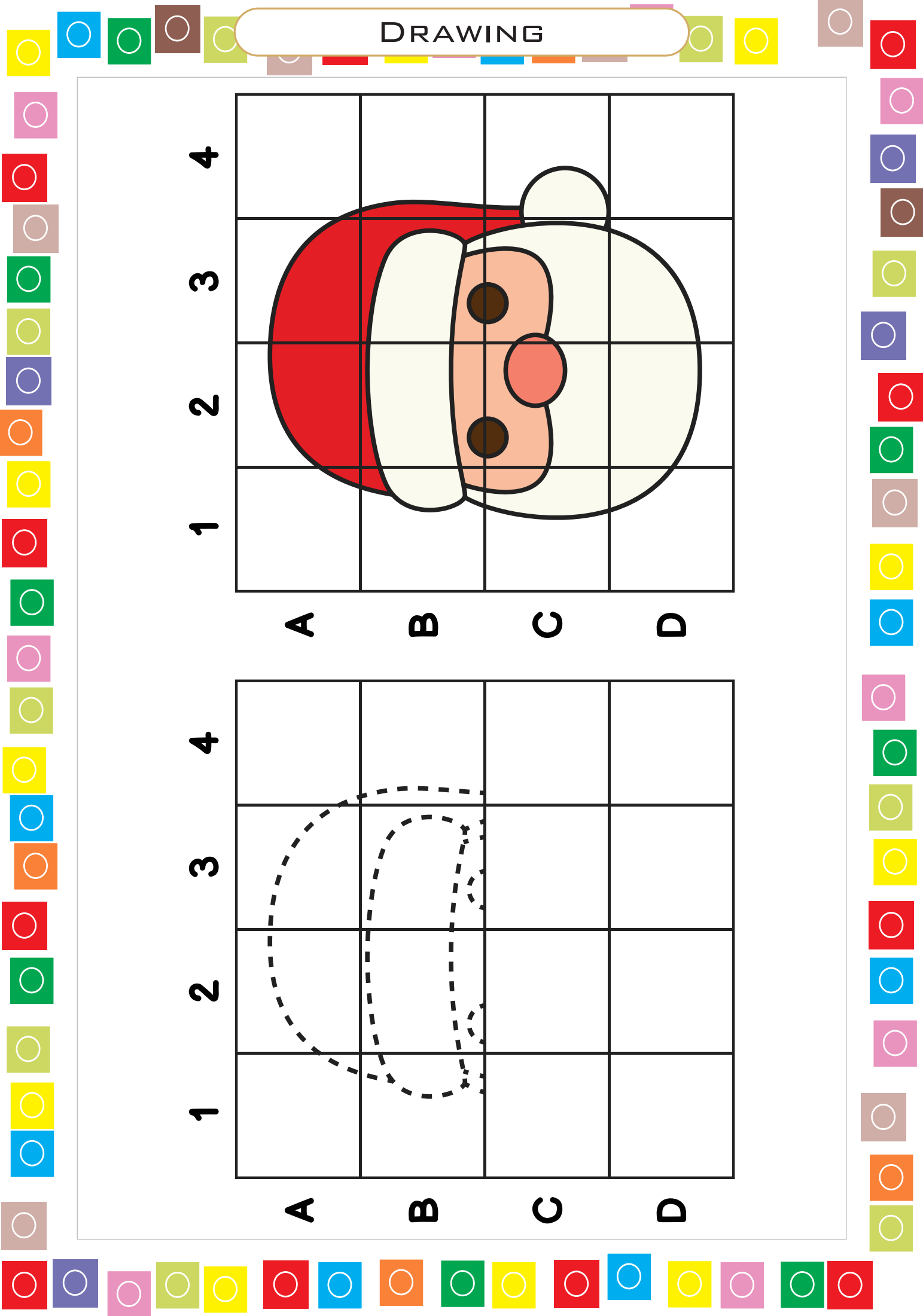

DRAWING

4
3
2
1

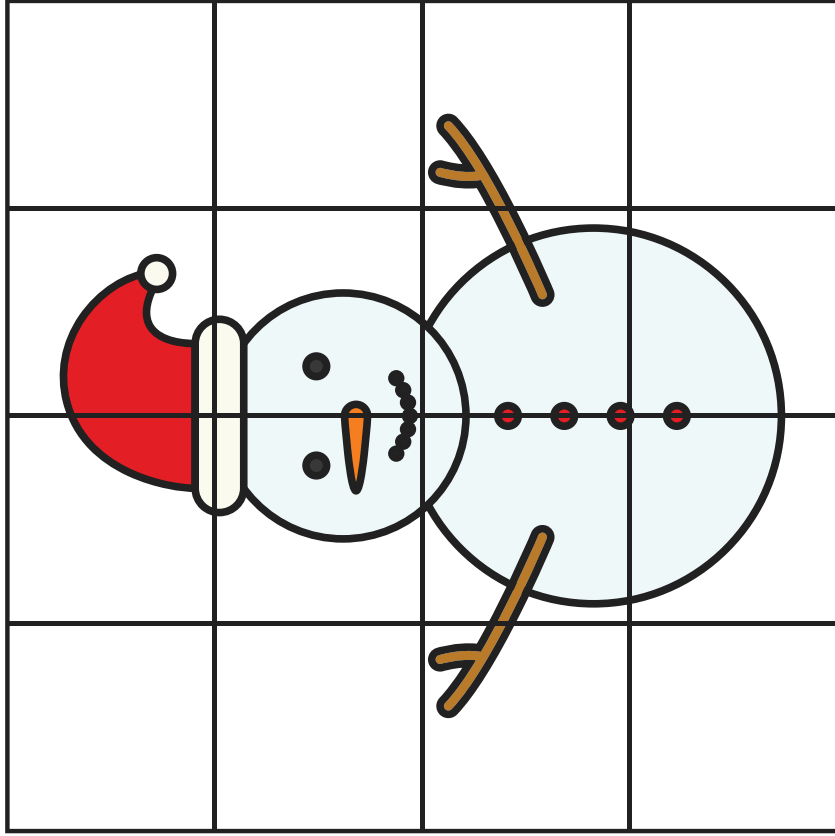

A B C D

4
3
2
1

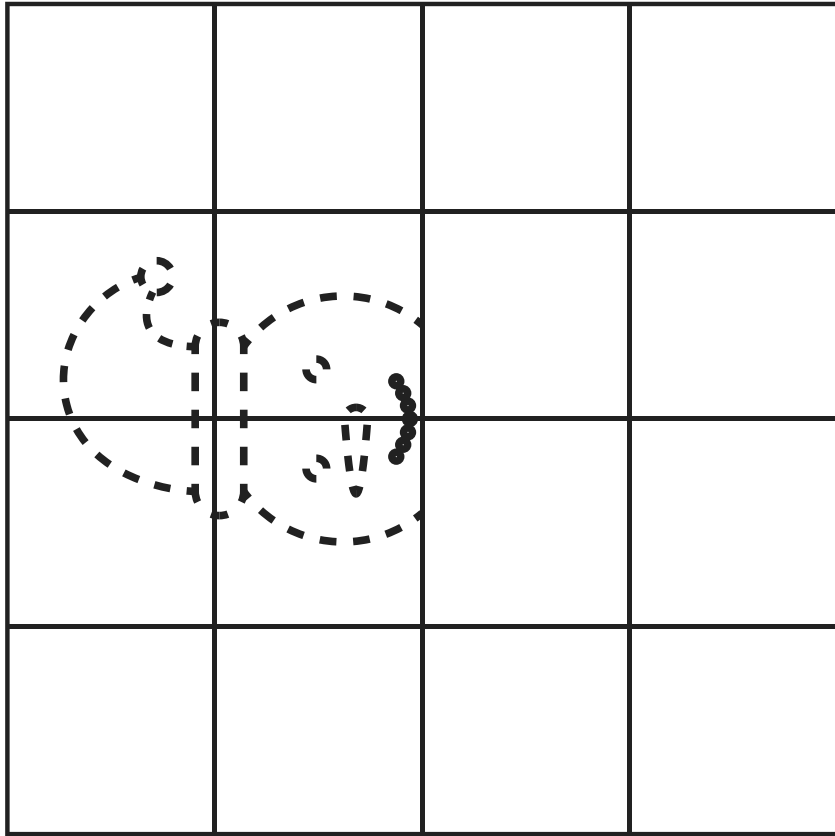

A B C D

DRAWING

4
3
2
1

A B C D

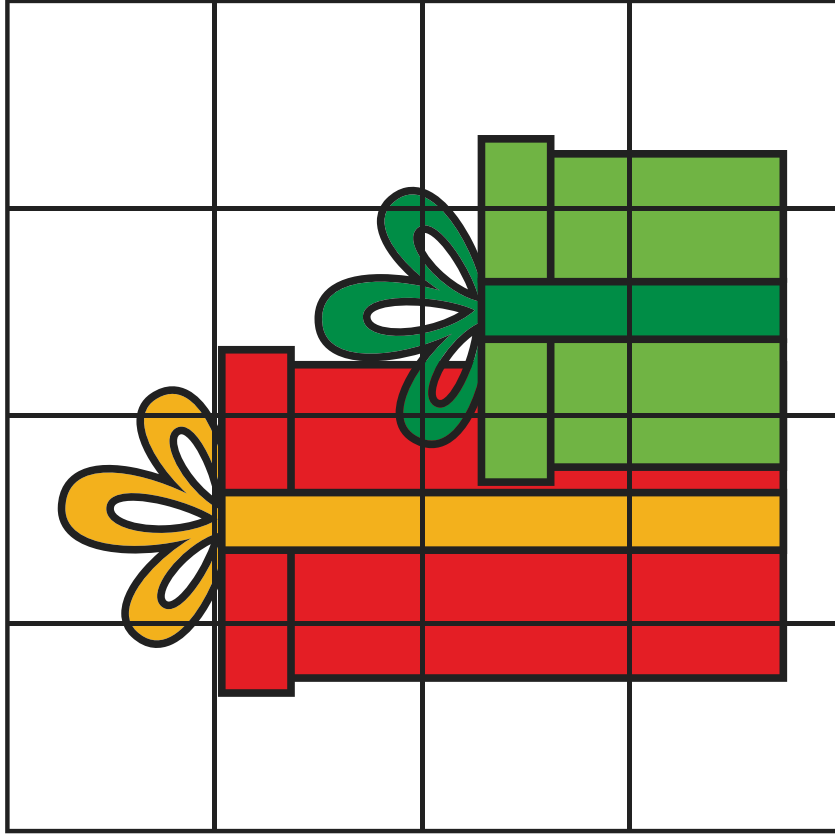

4
3
2
1

A B C D

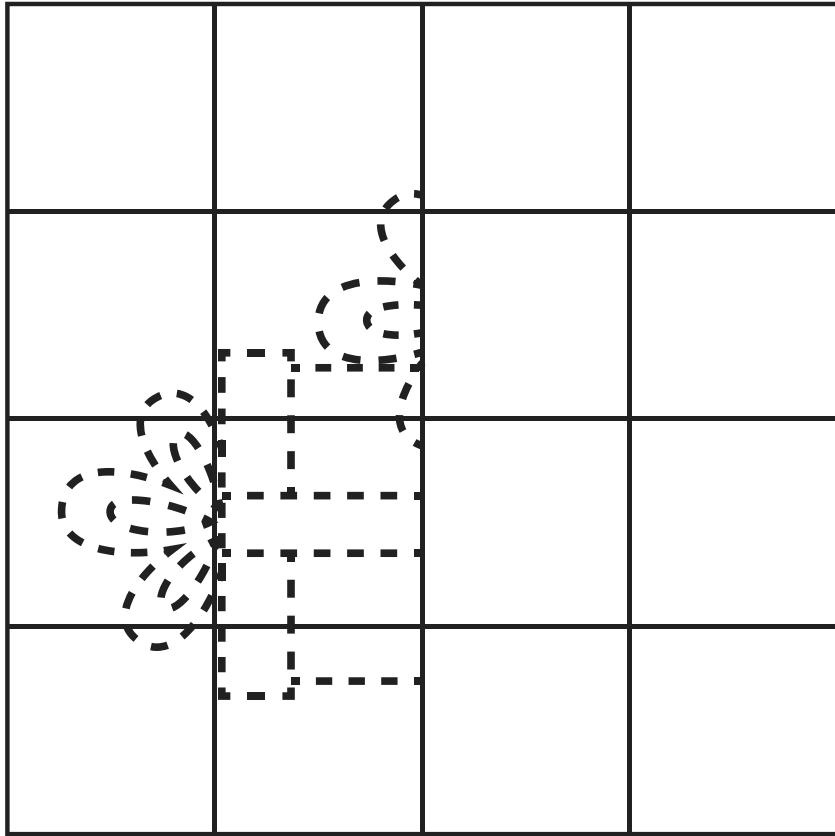

DRAWING

4
3
2
1

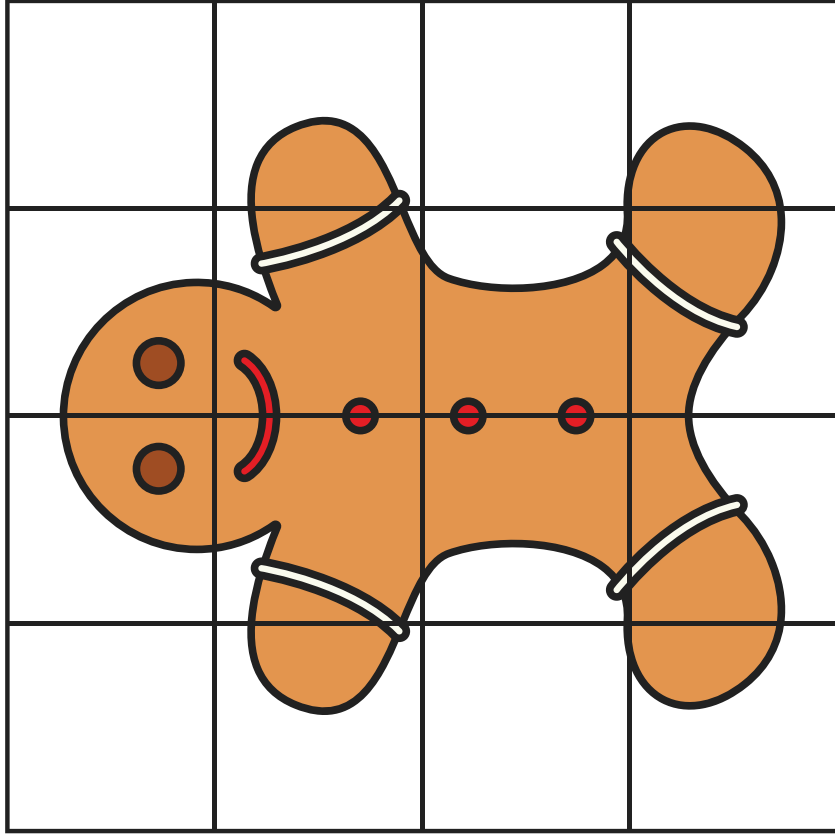

A B C D

4
3
2
1

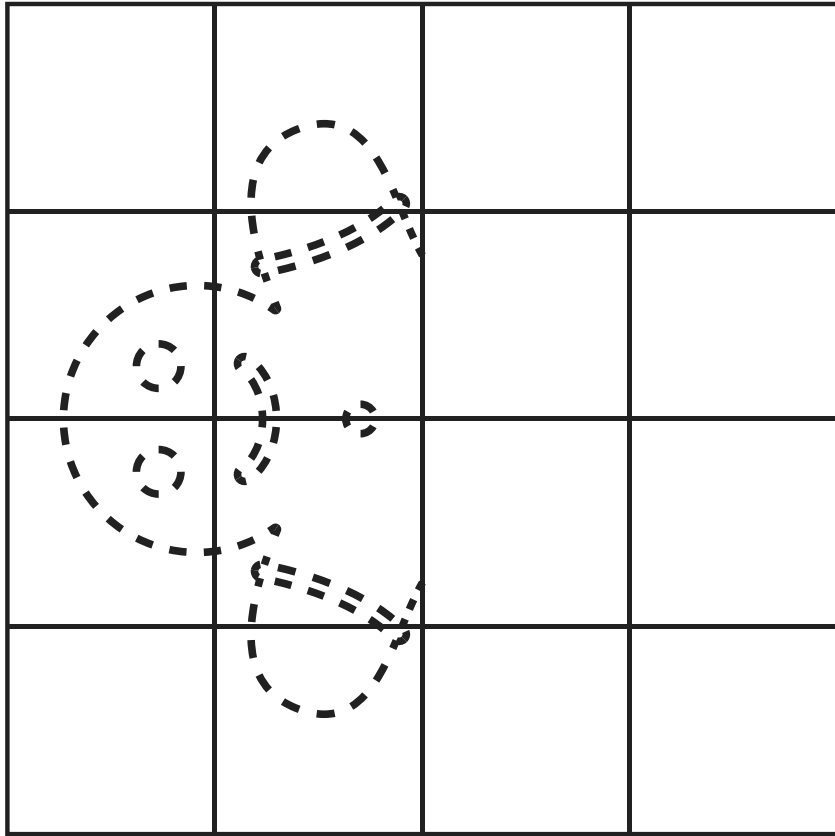

A B C D

DRAWING

4
3
2
1

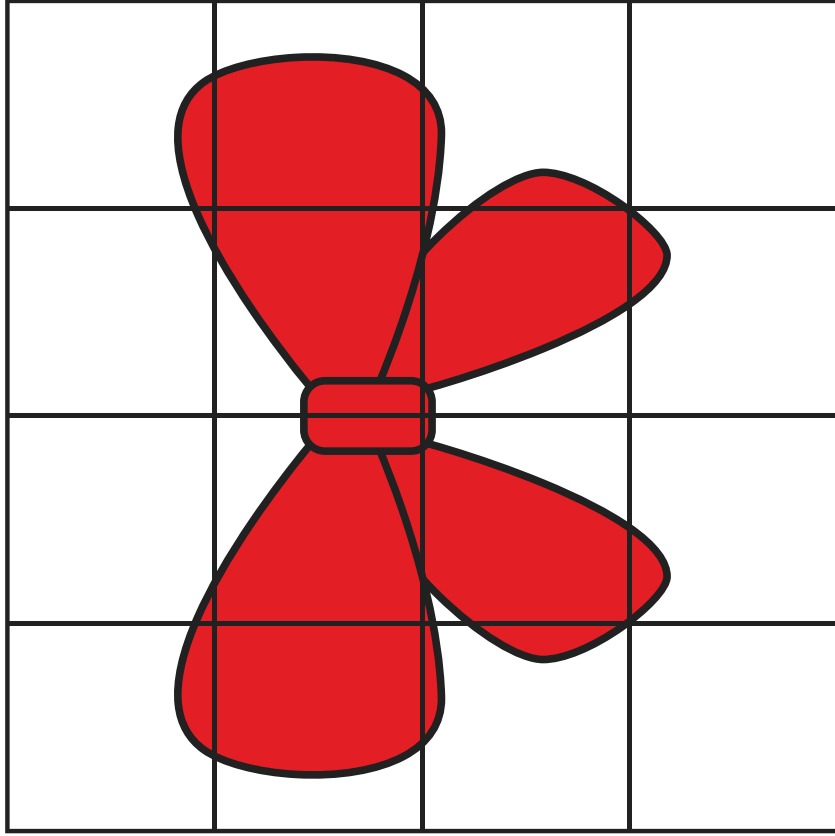

A B C D

4
3
2
1

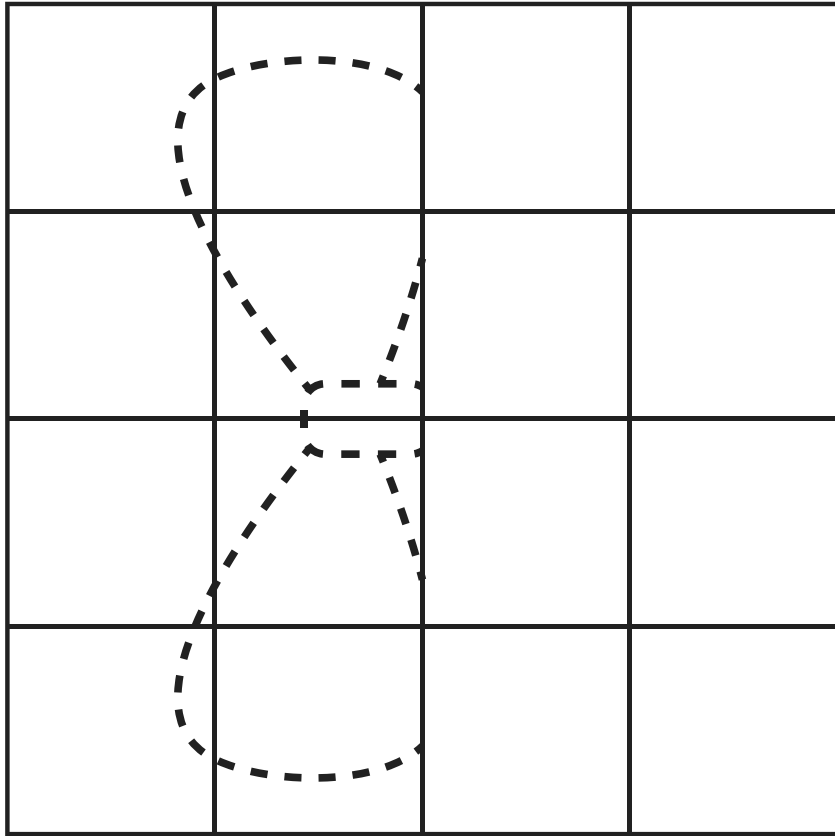

A B C D

DRAWING

4
3
2
1

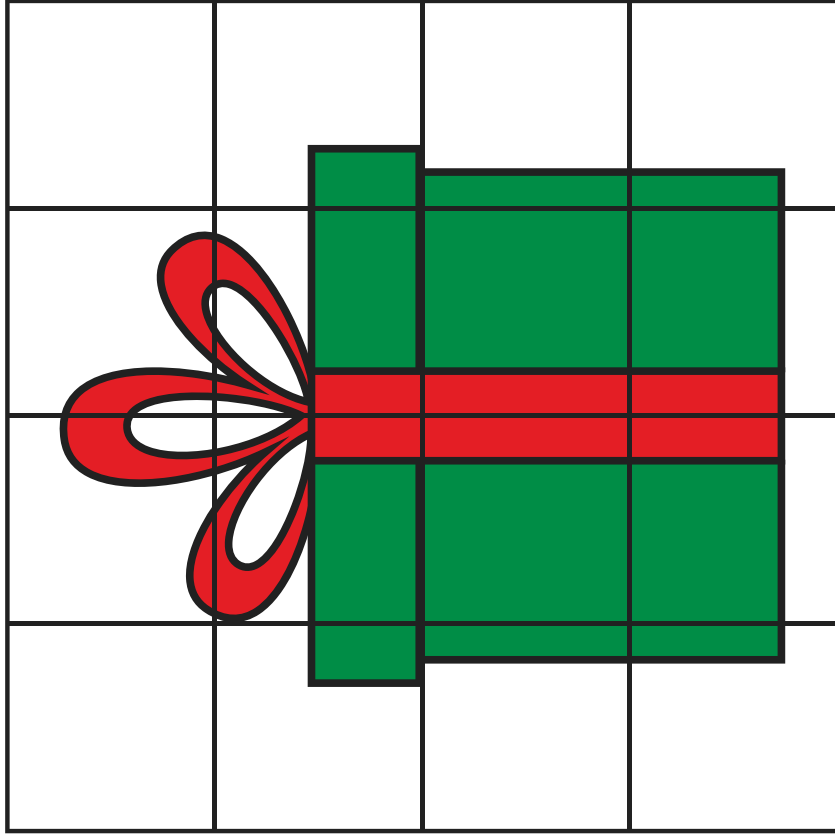

A B C D

4
3
2
1

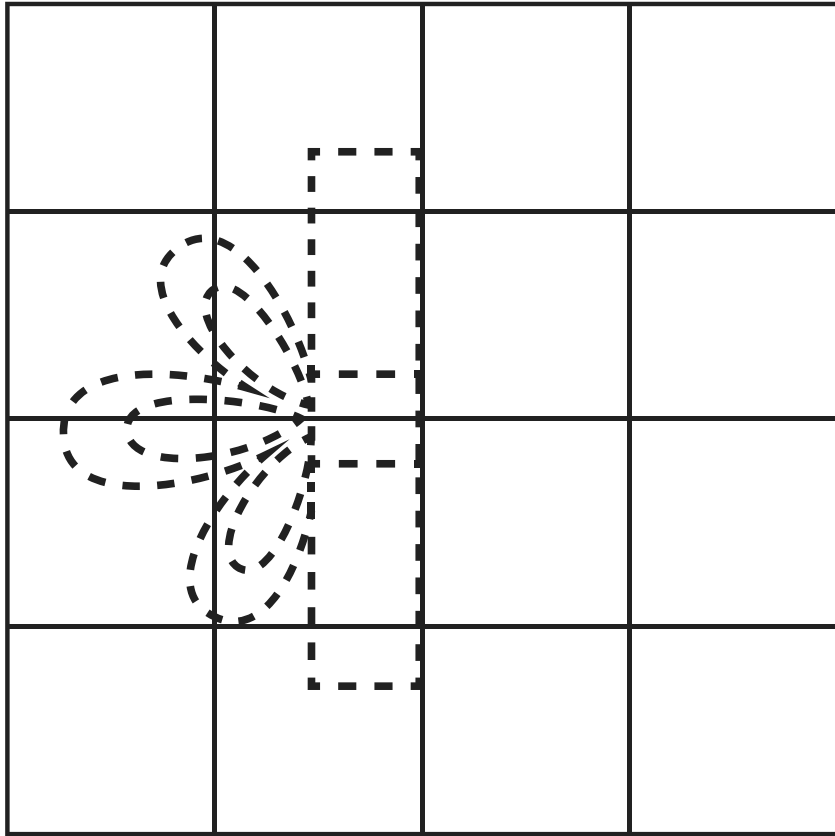

A B C D

DRAWING

4
3
2
1

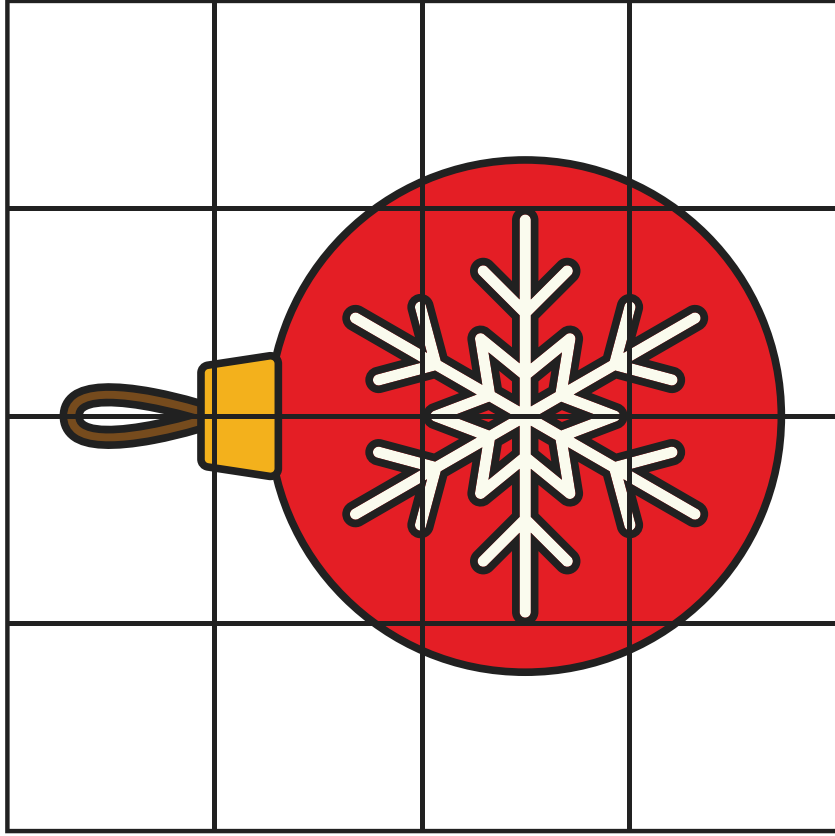

A B C D

4
3
2
1

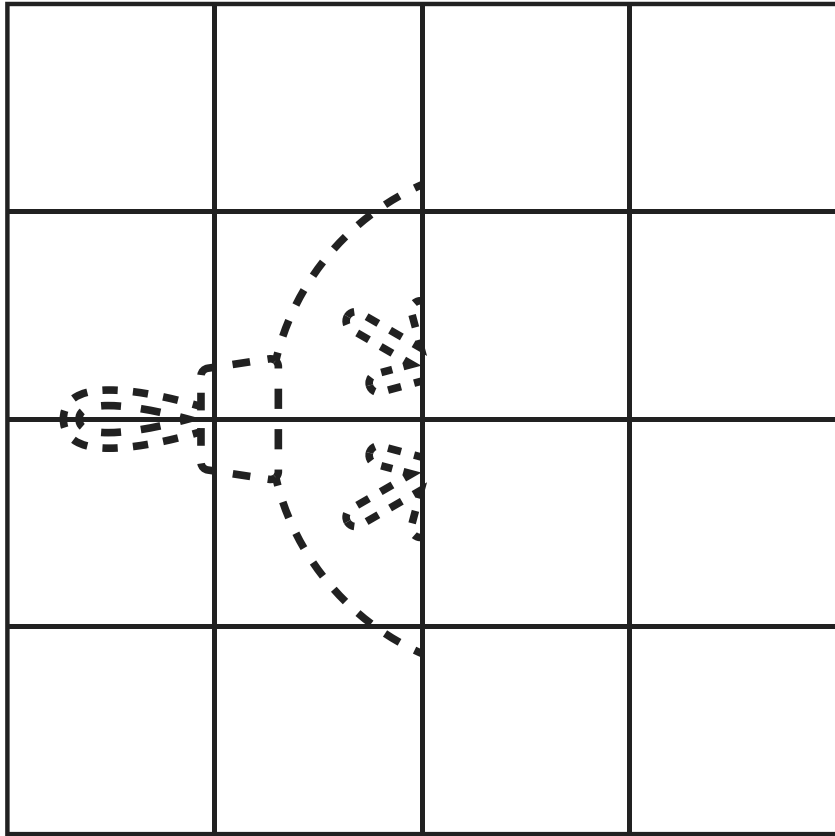

A B C D

DRAWING

4
3
2
1

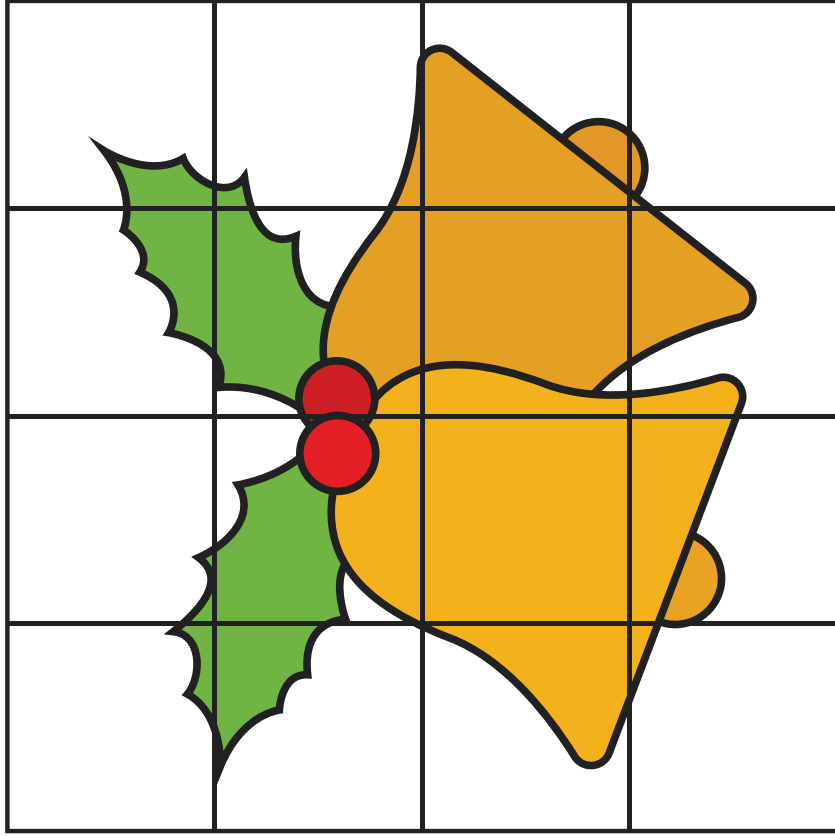

A B C D

4
3
2
1

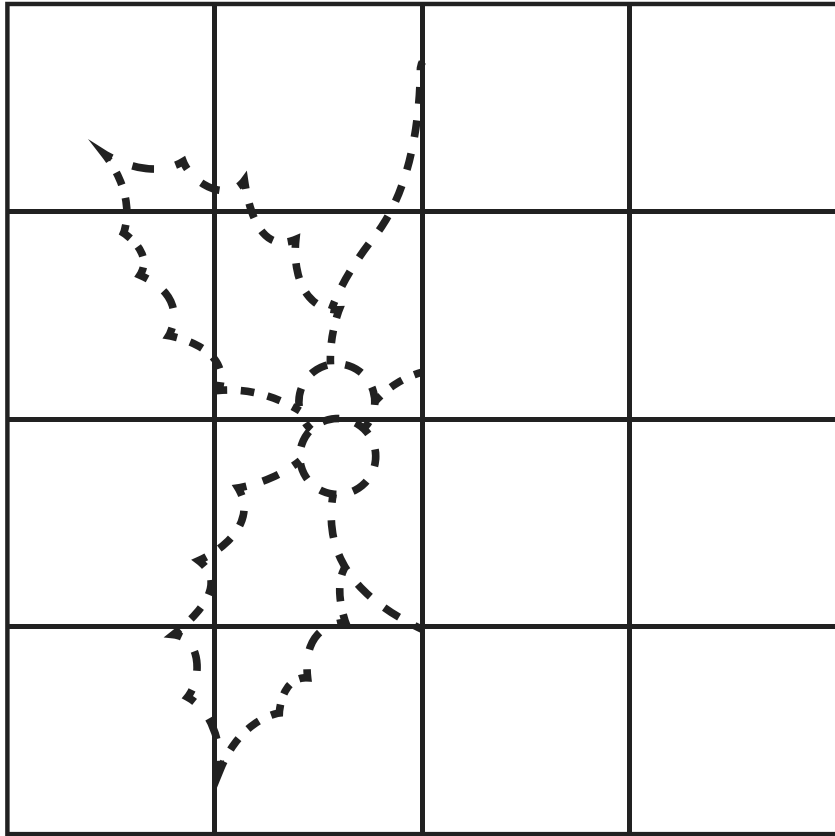

A B C D

DRAWING

4
3
2
1

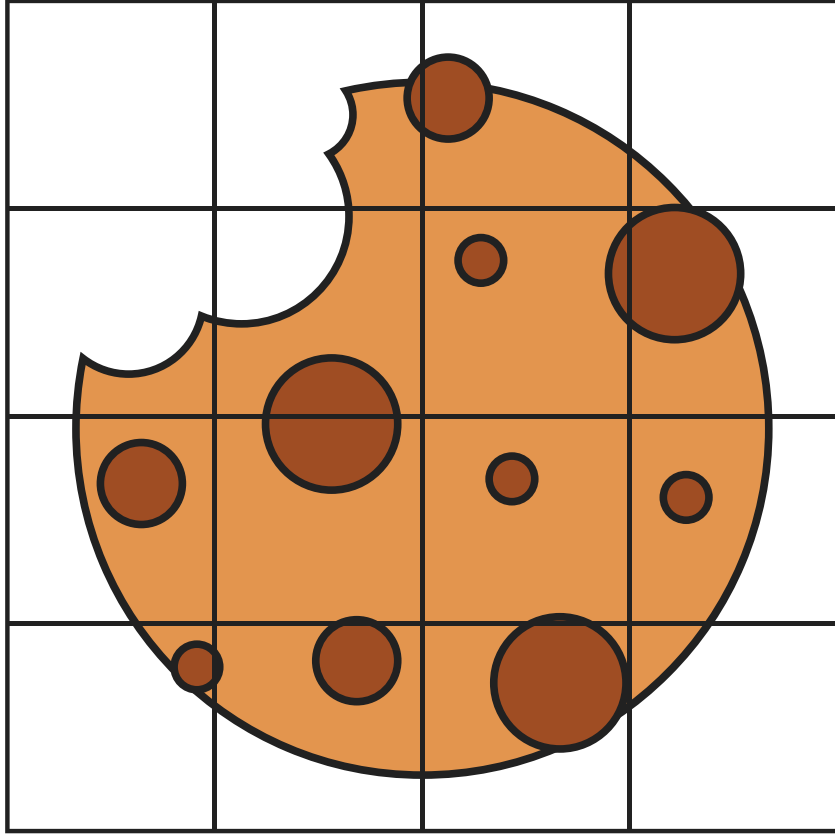

A B C D

4
3
2
1

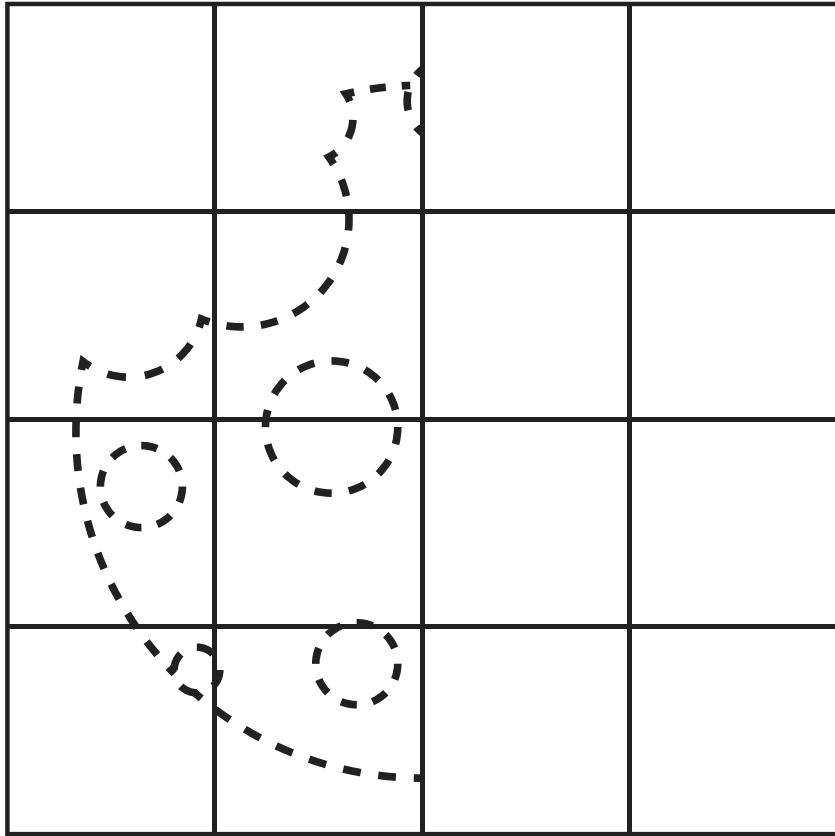

A B C D

DRAWING

4
3
2
1

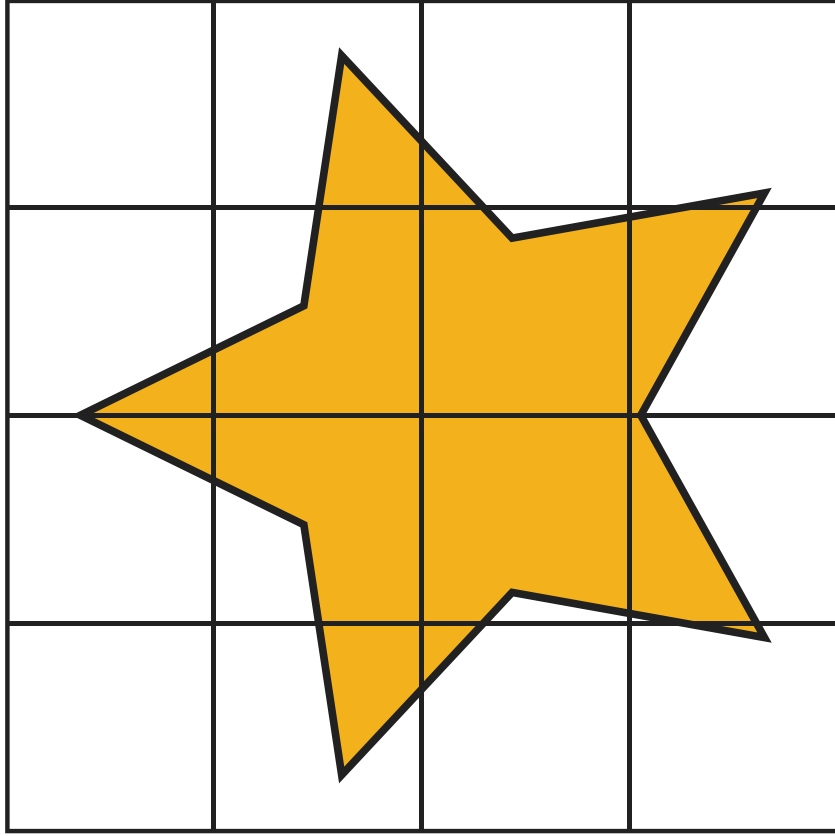

A B C D

4
3
2
1

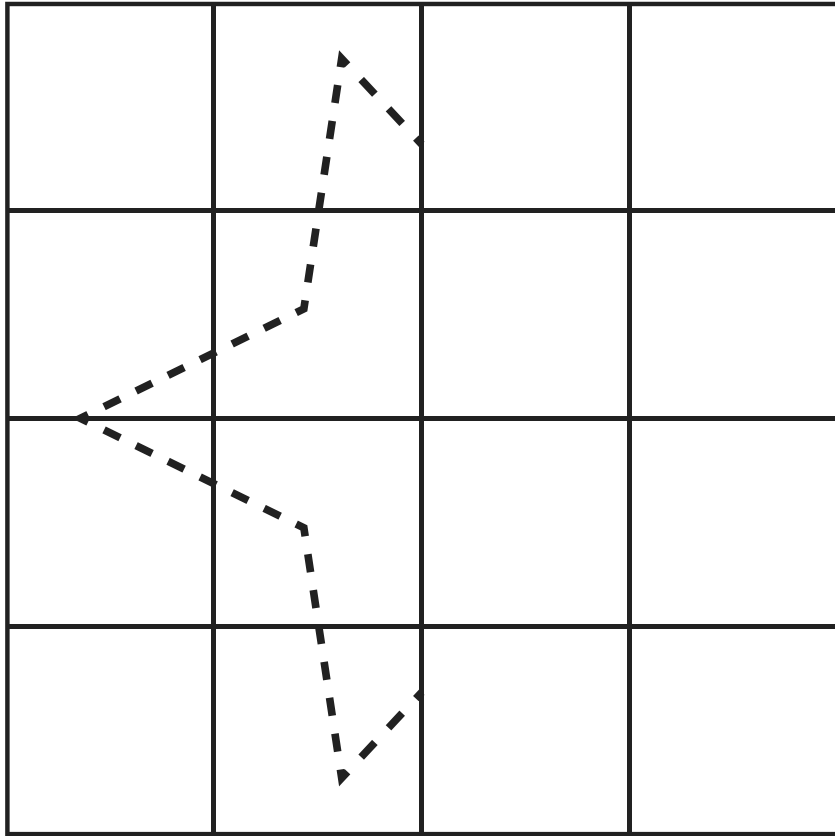

A B C D

DRAWING

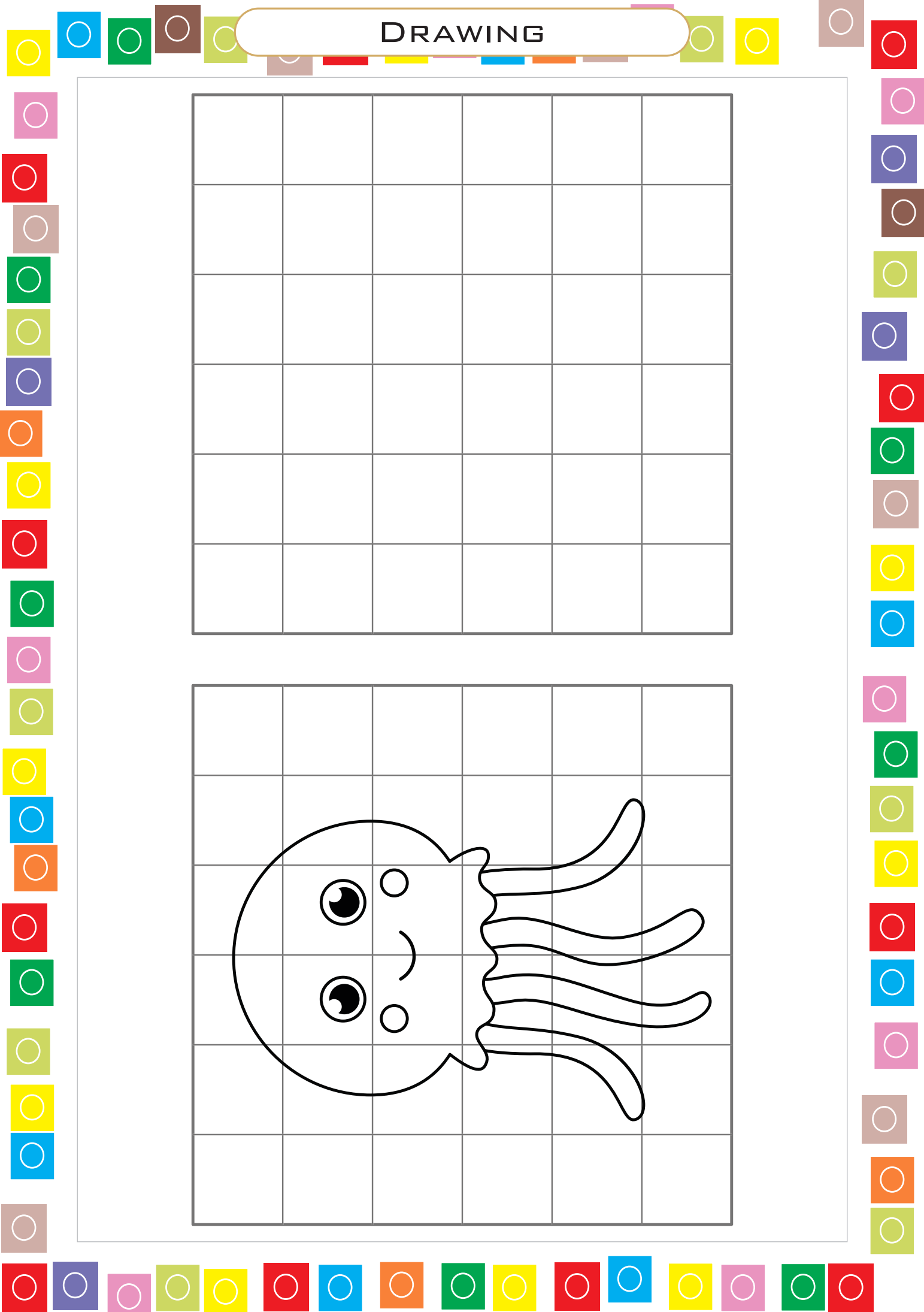
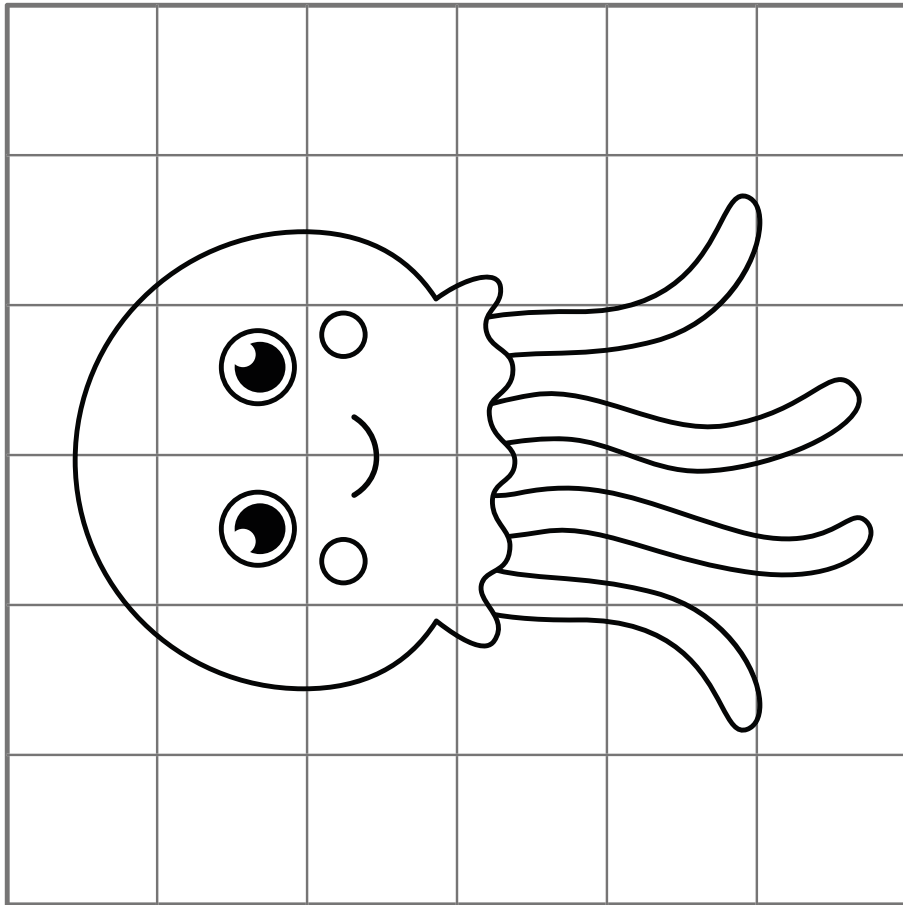
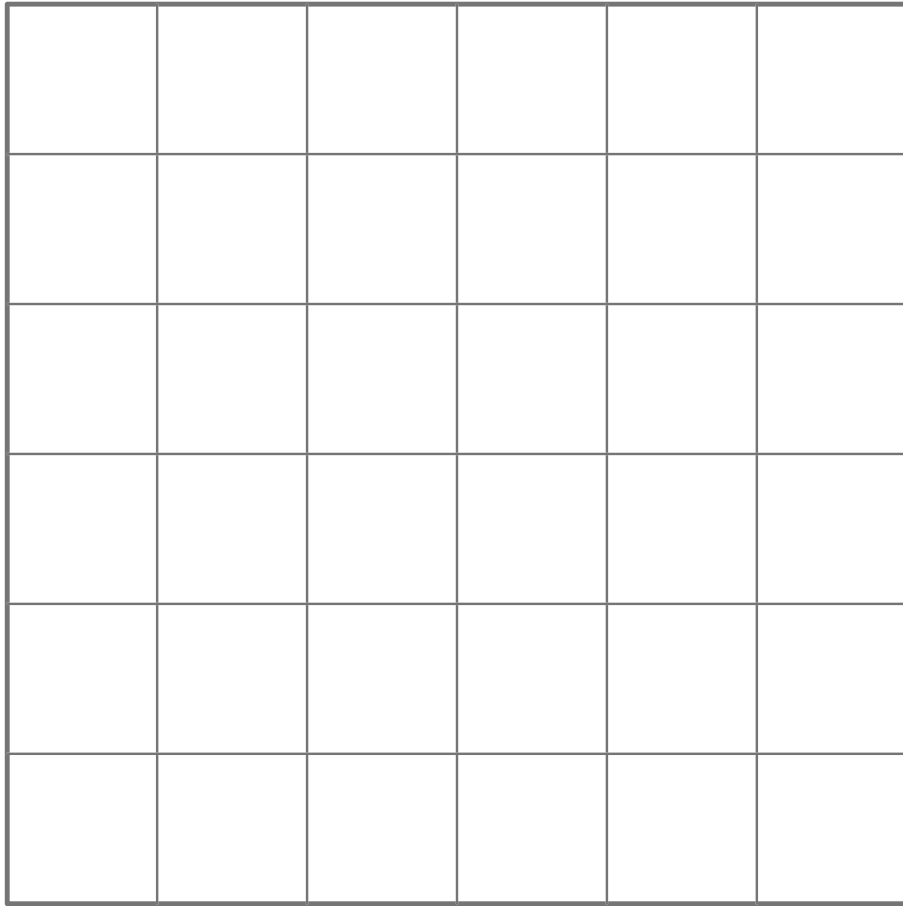

DRAWING

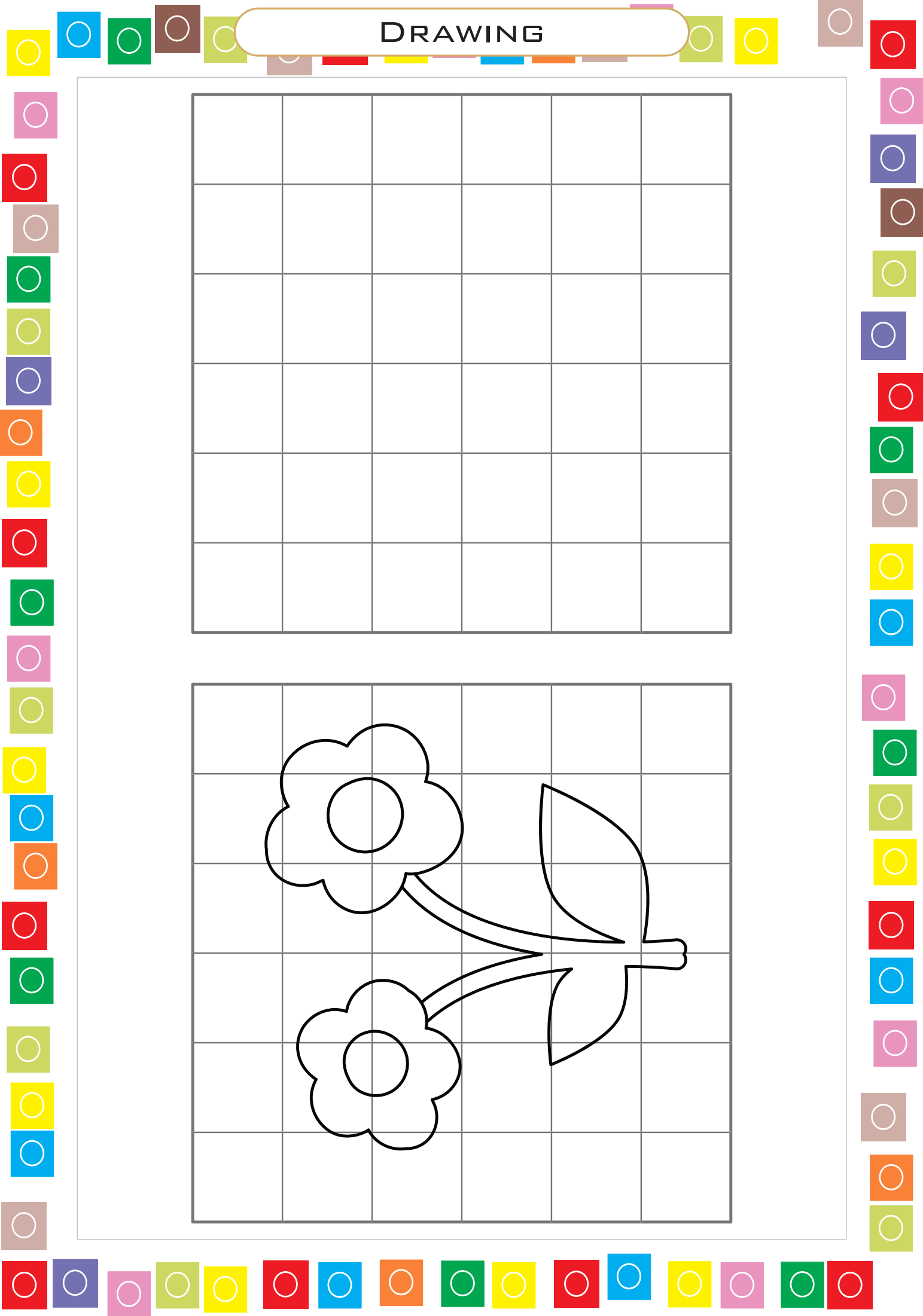
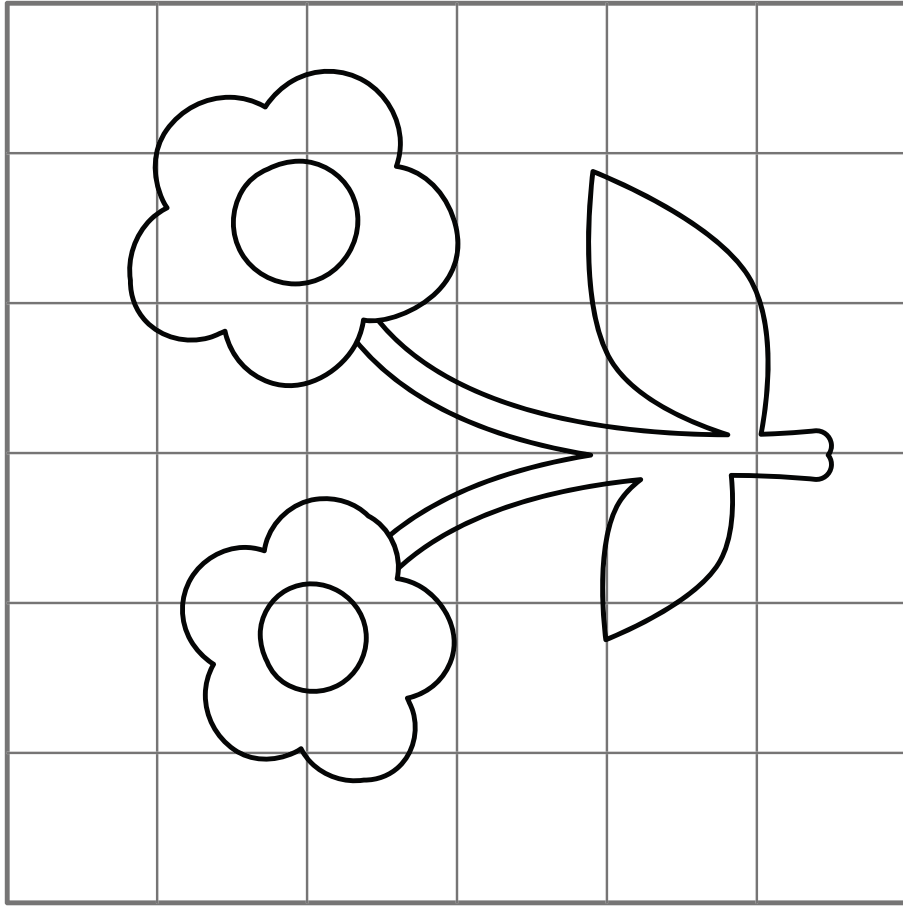
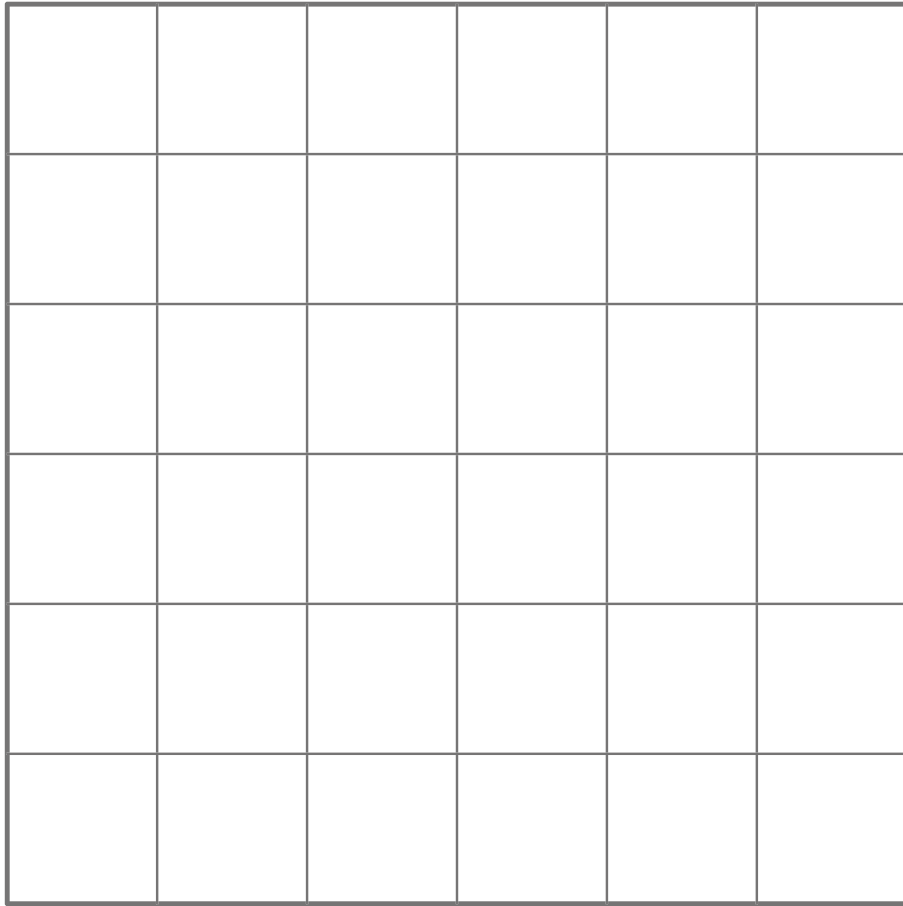

DRAWING

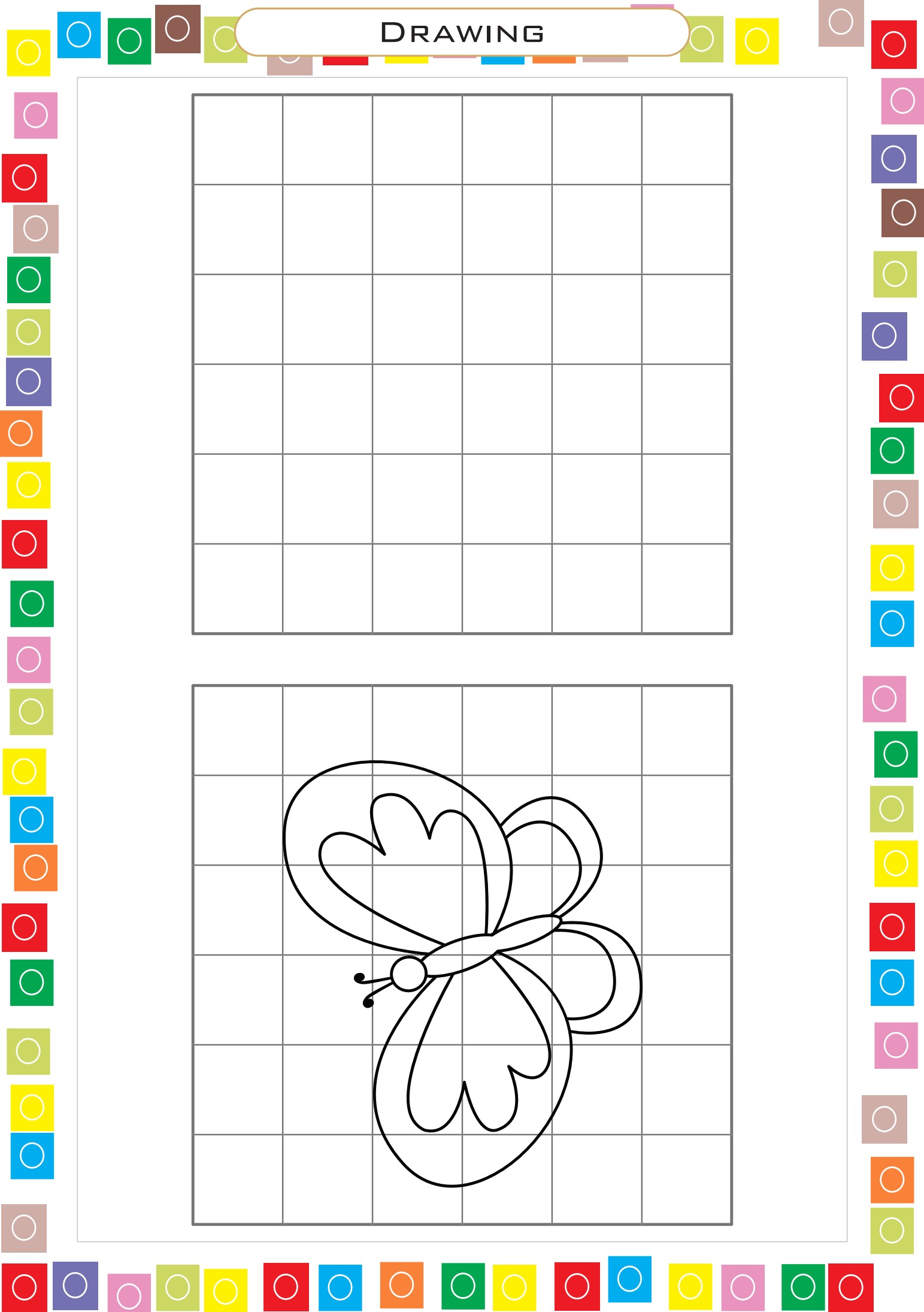
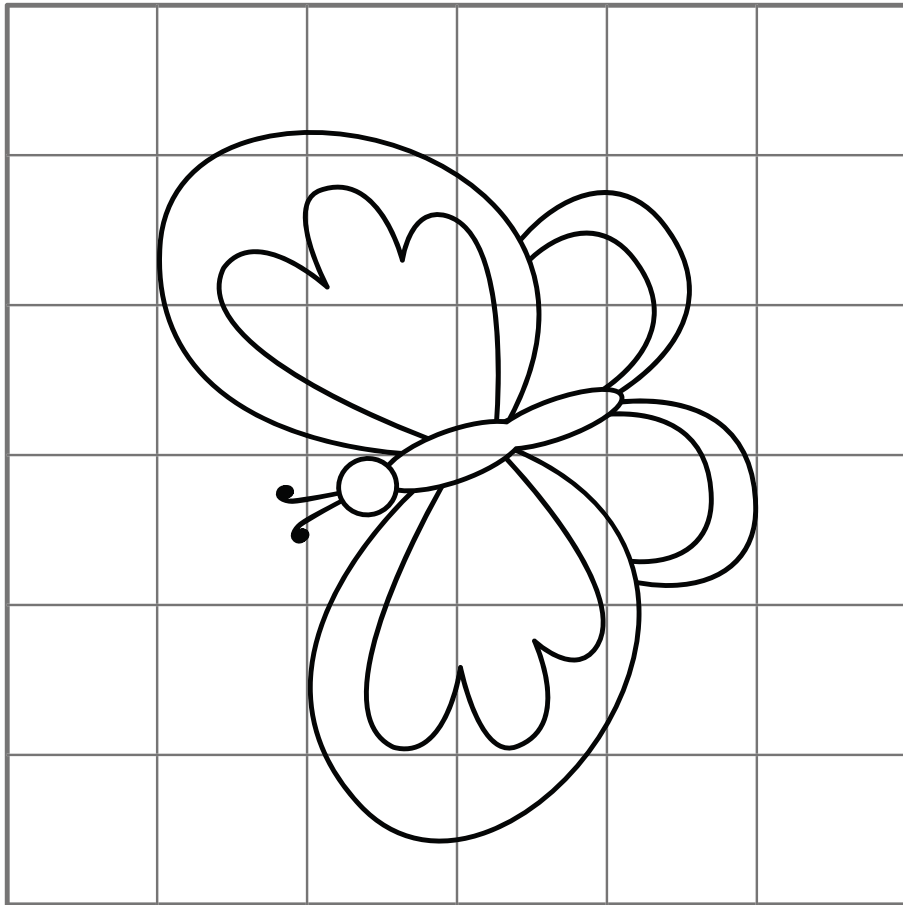
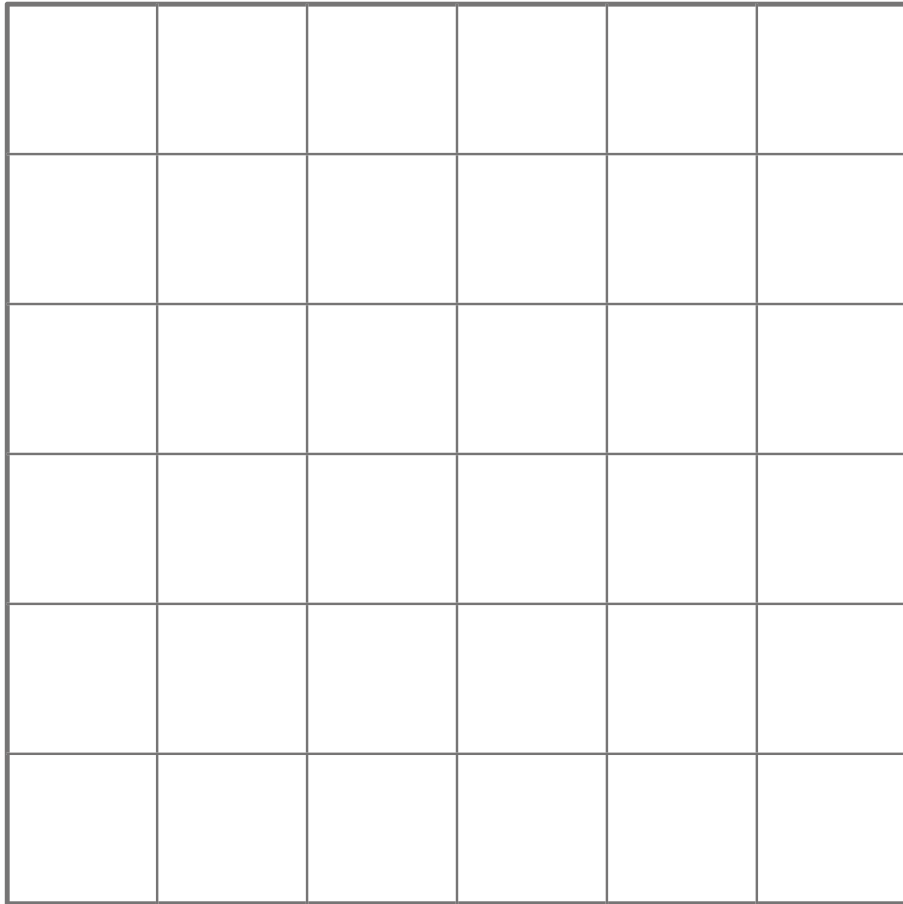

DRAWING

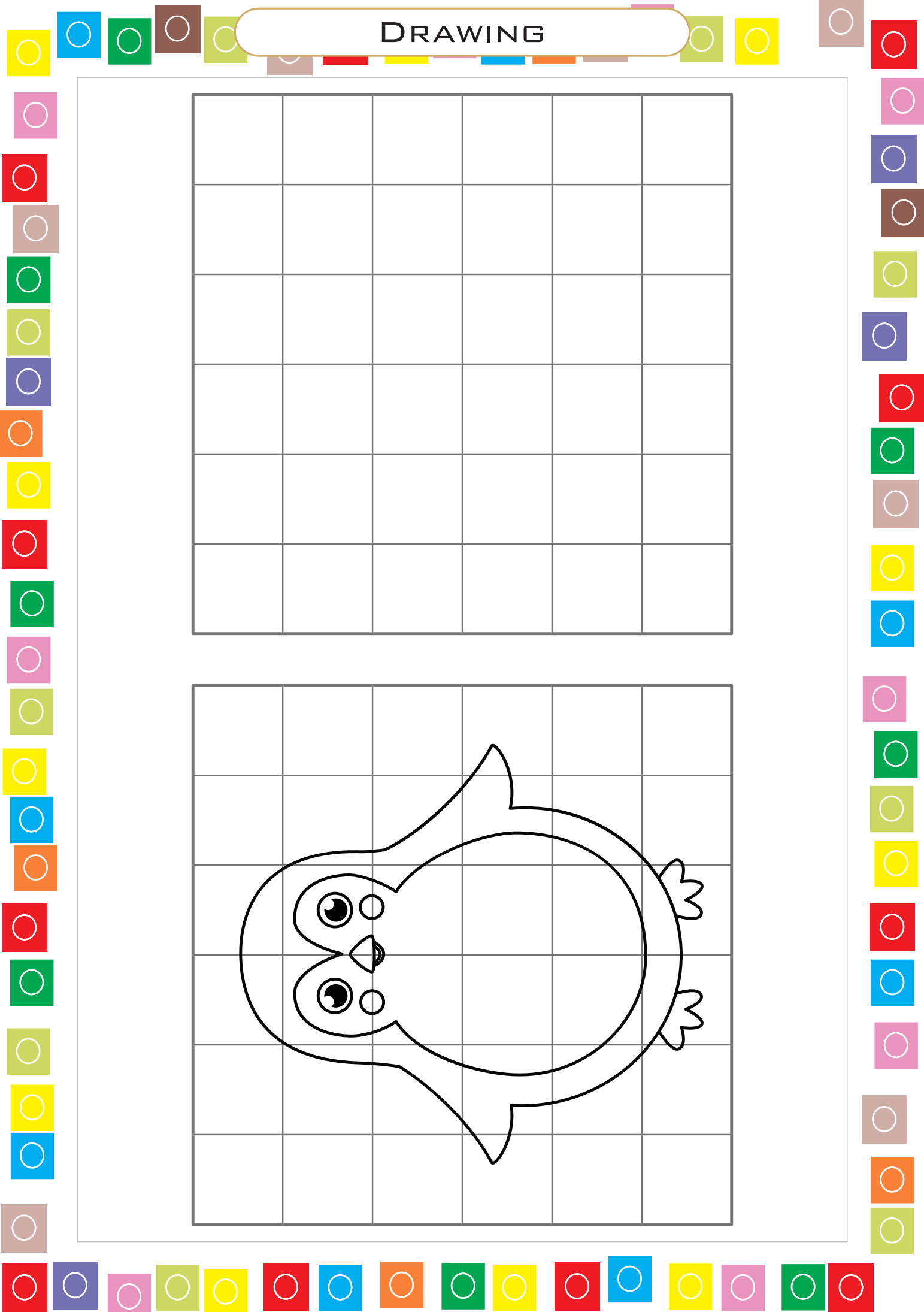
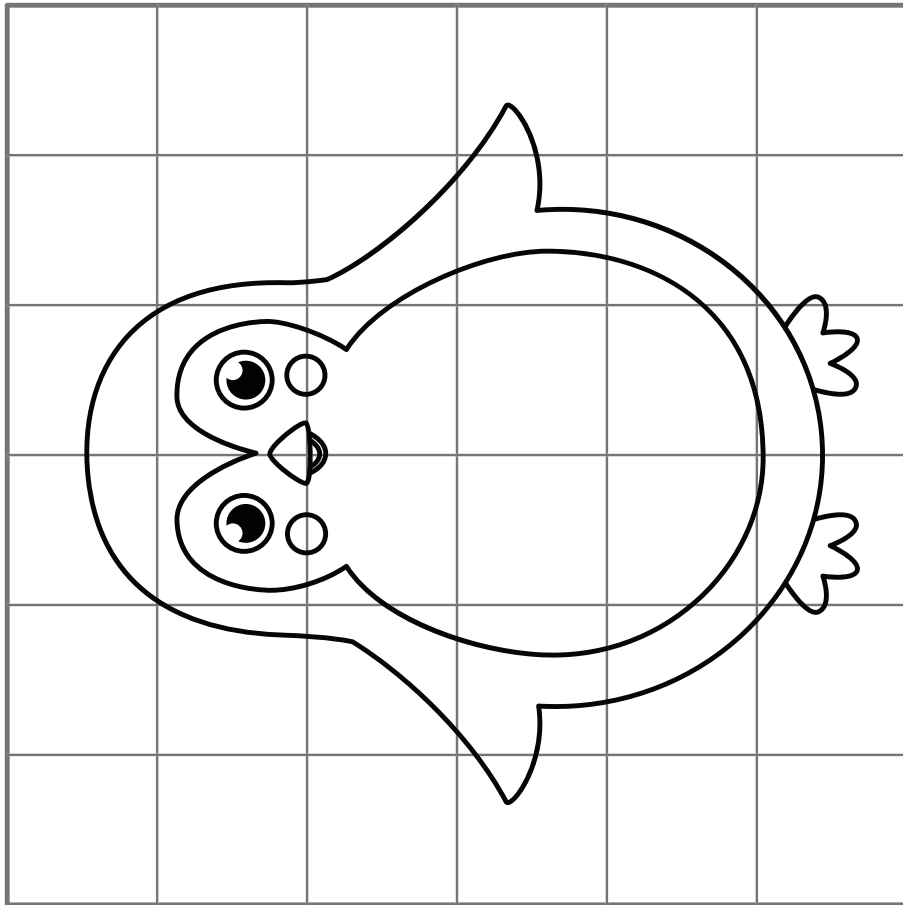
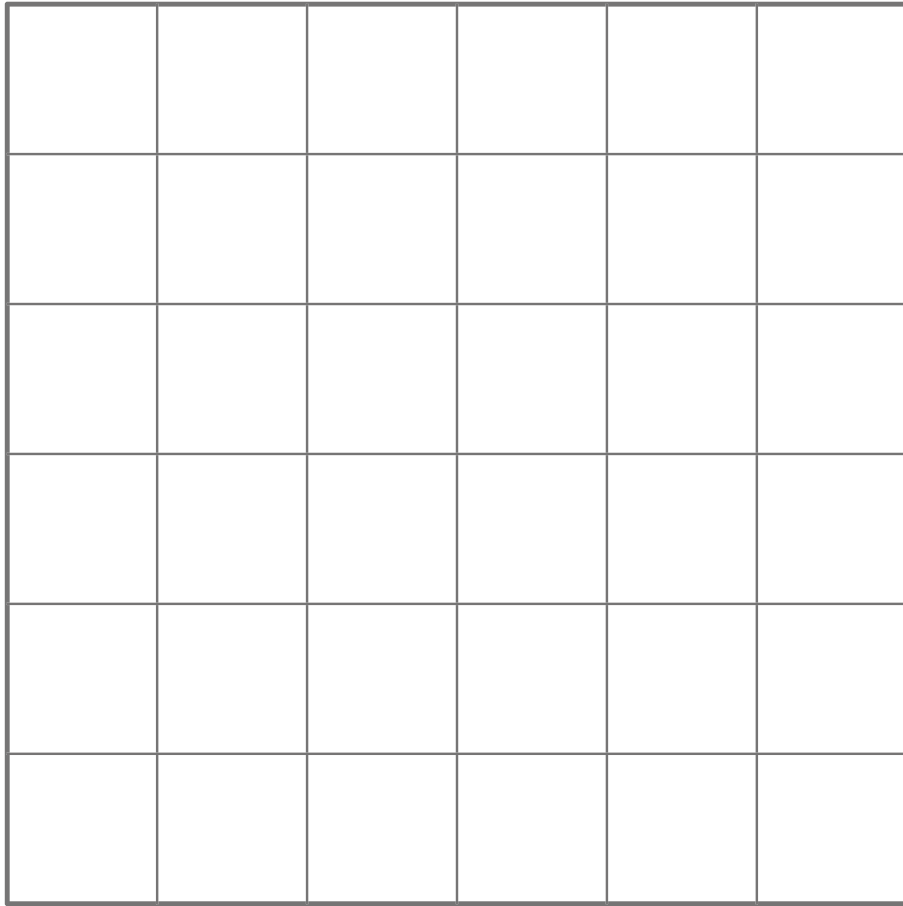

DRAWING

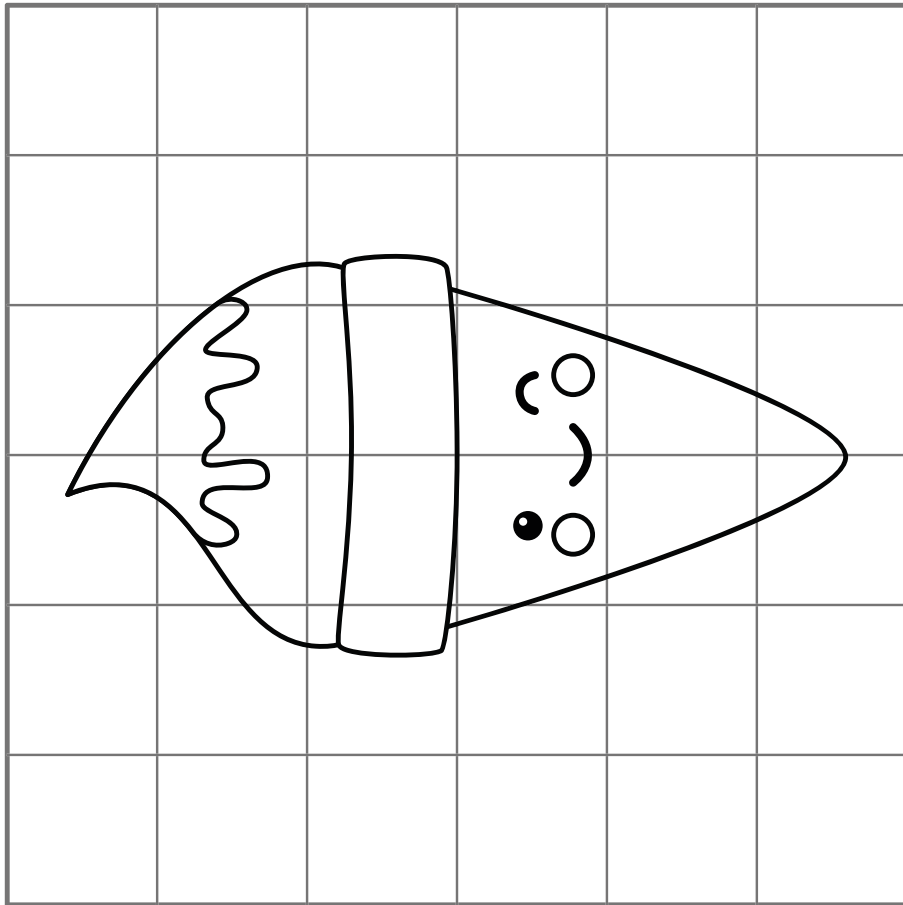
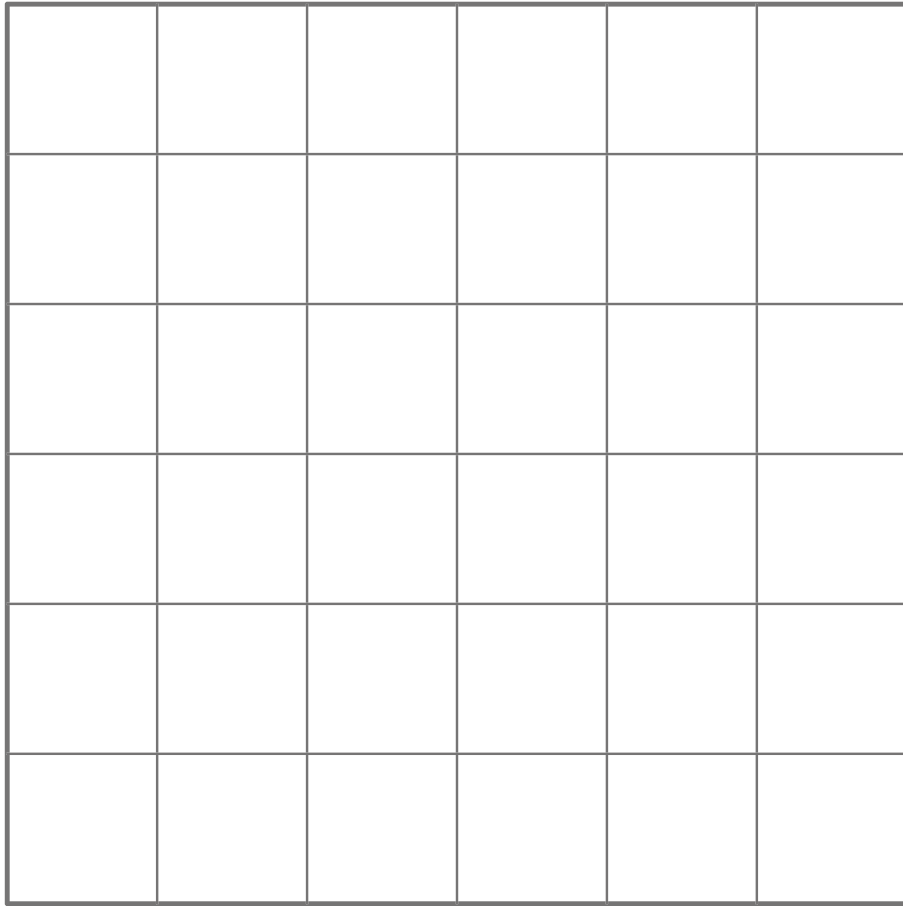

DRAWING

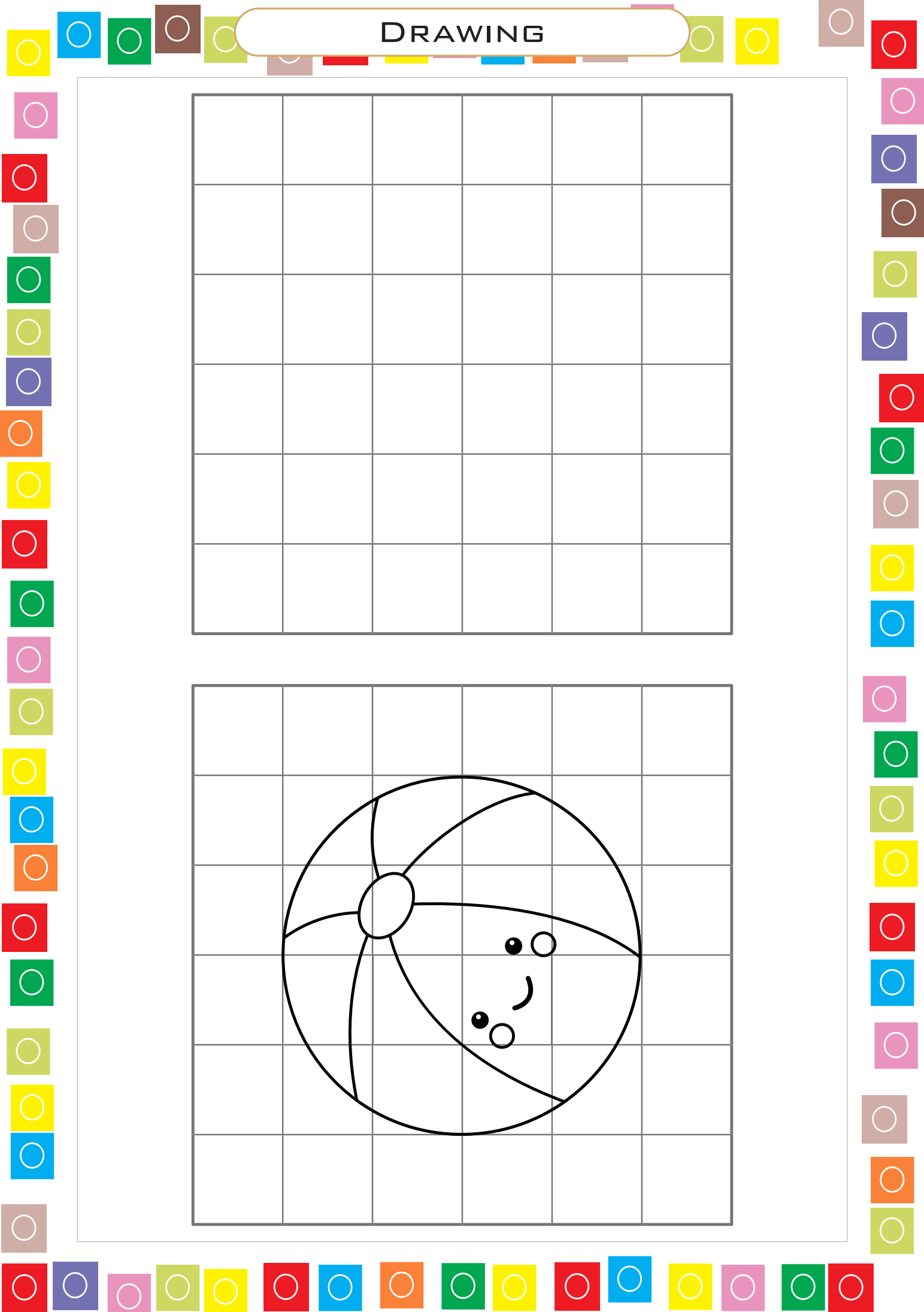
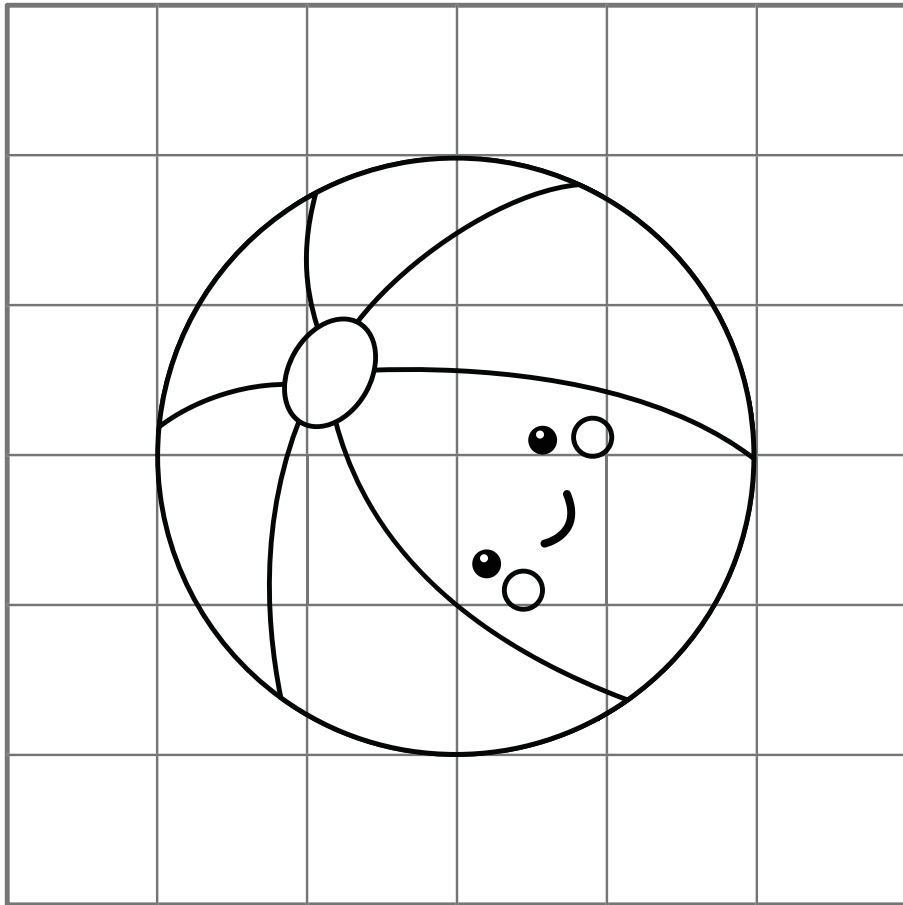
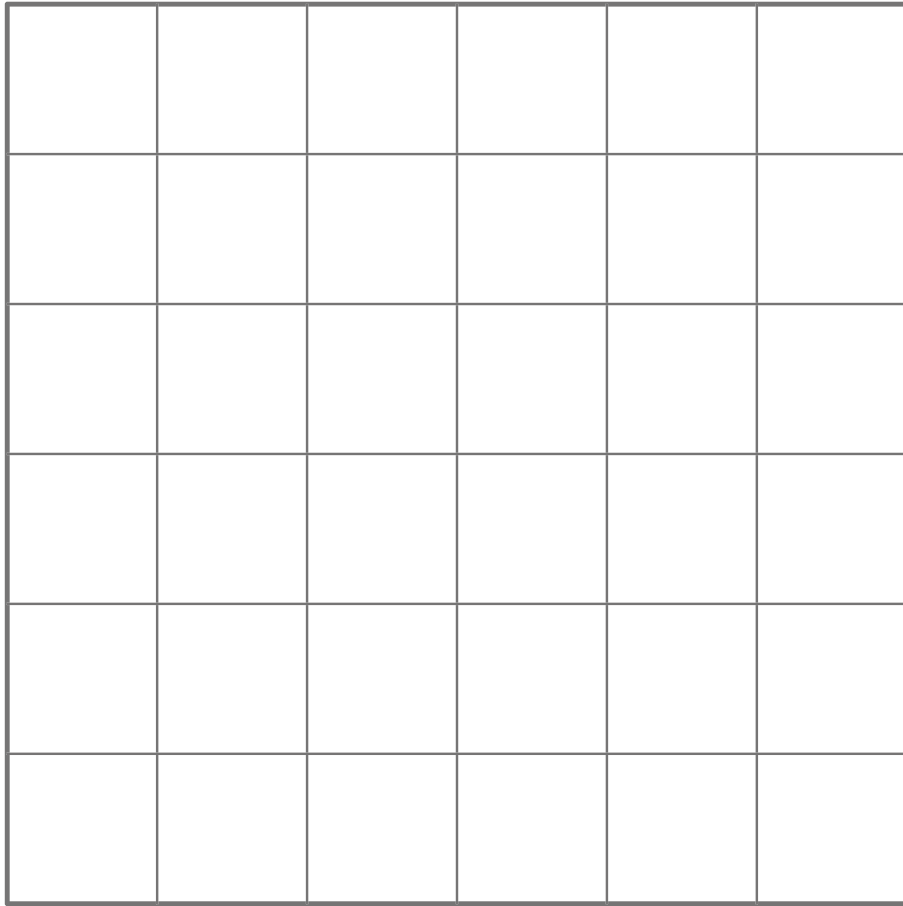

DRAWING

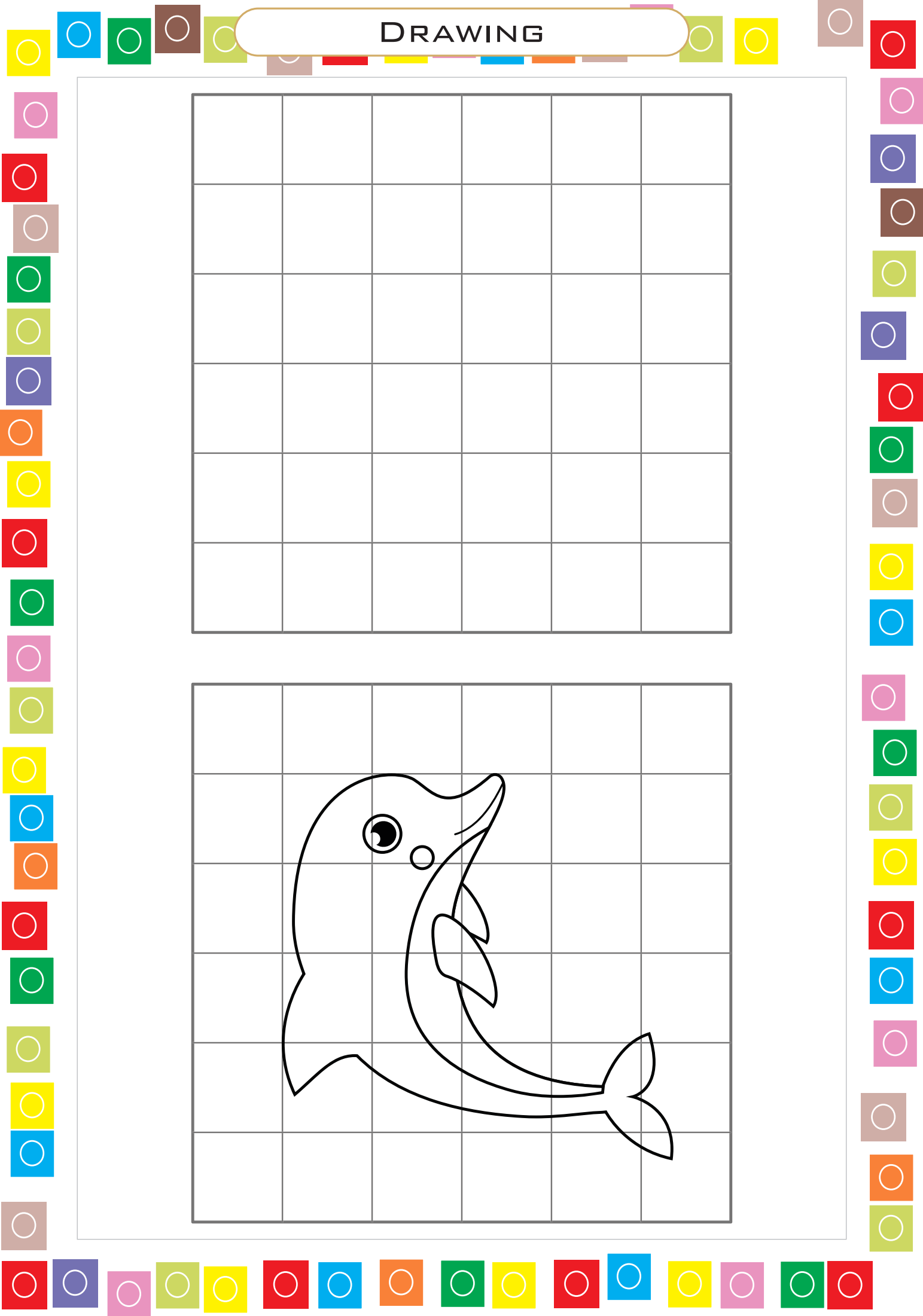
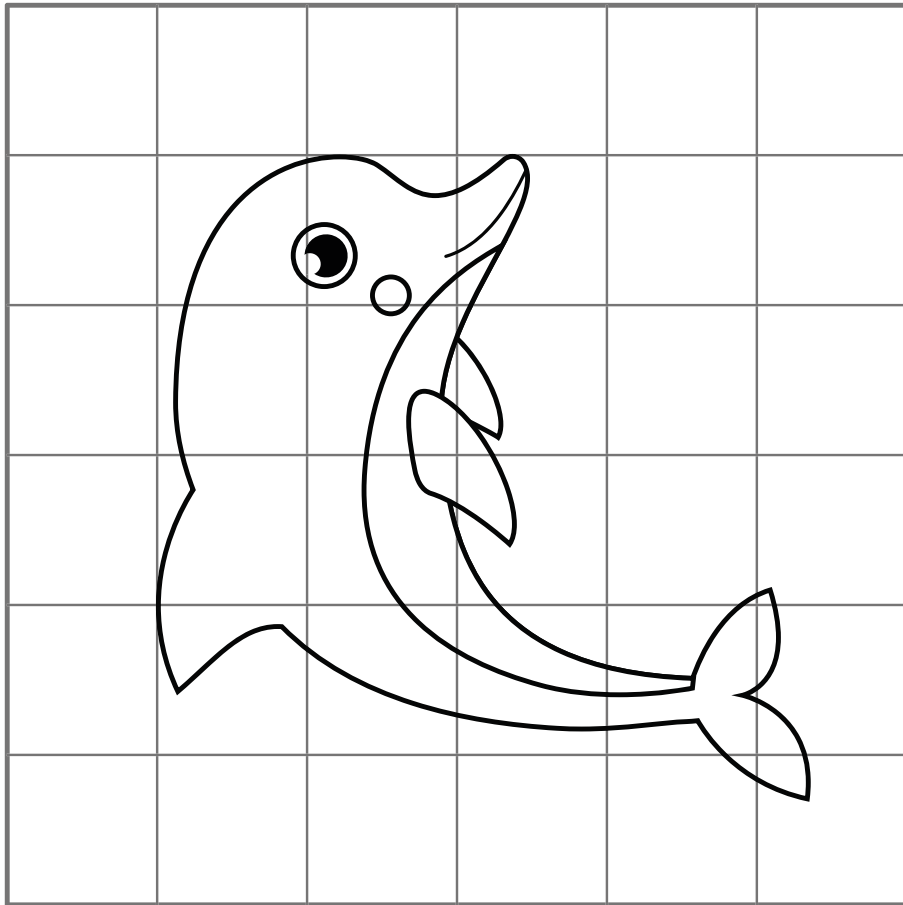
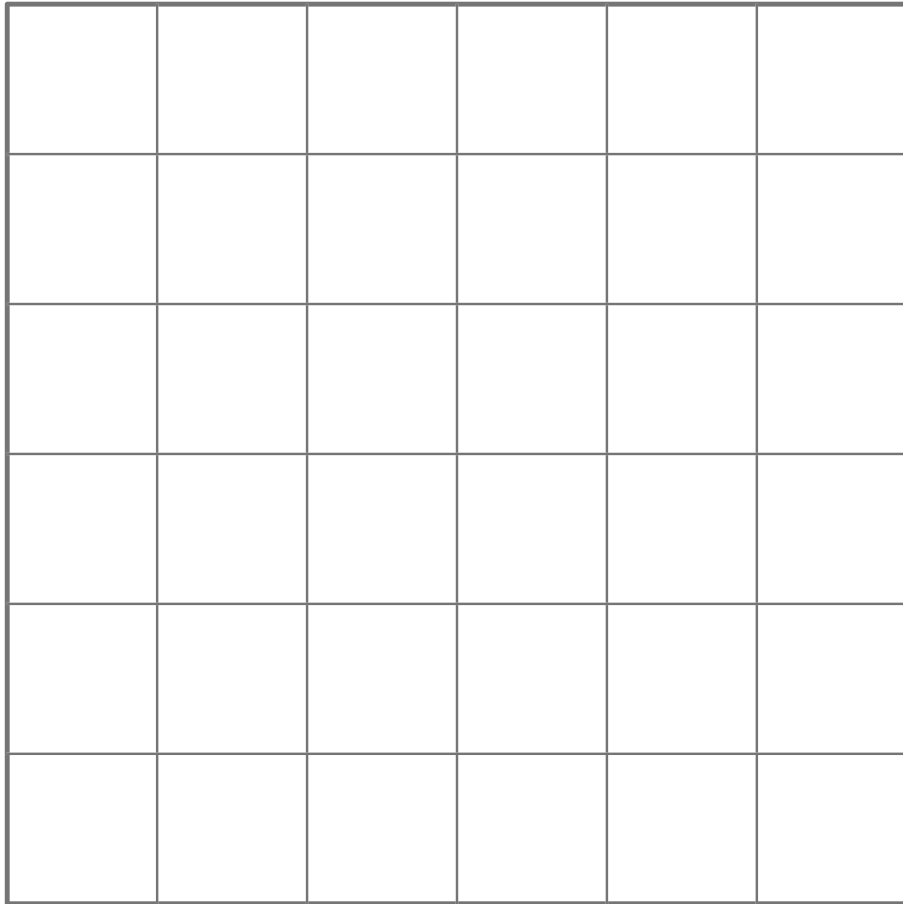

DRAWING

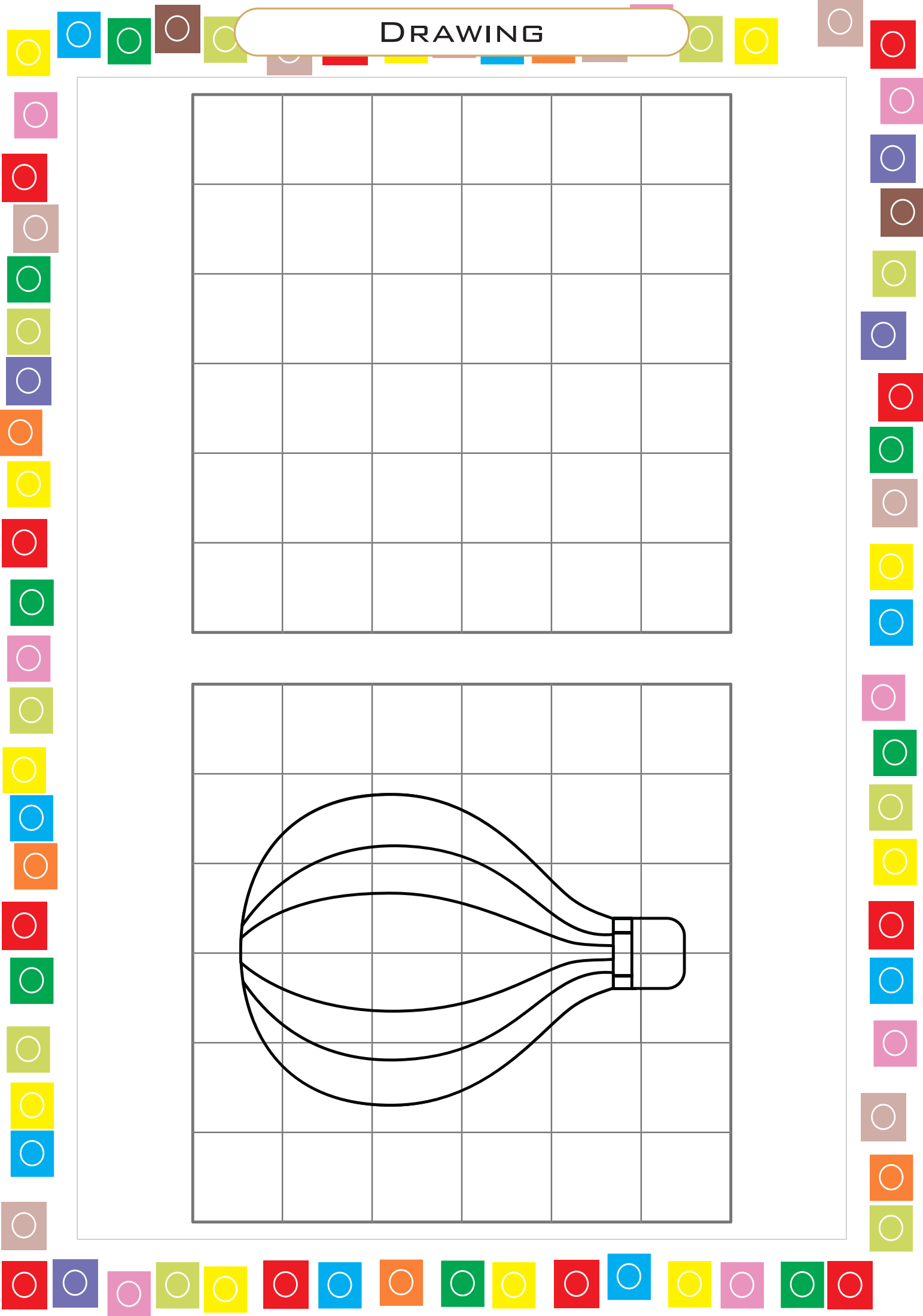
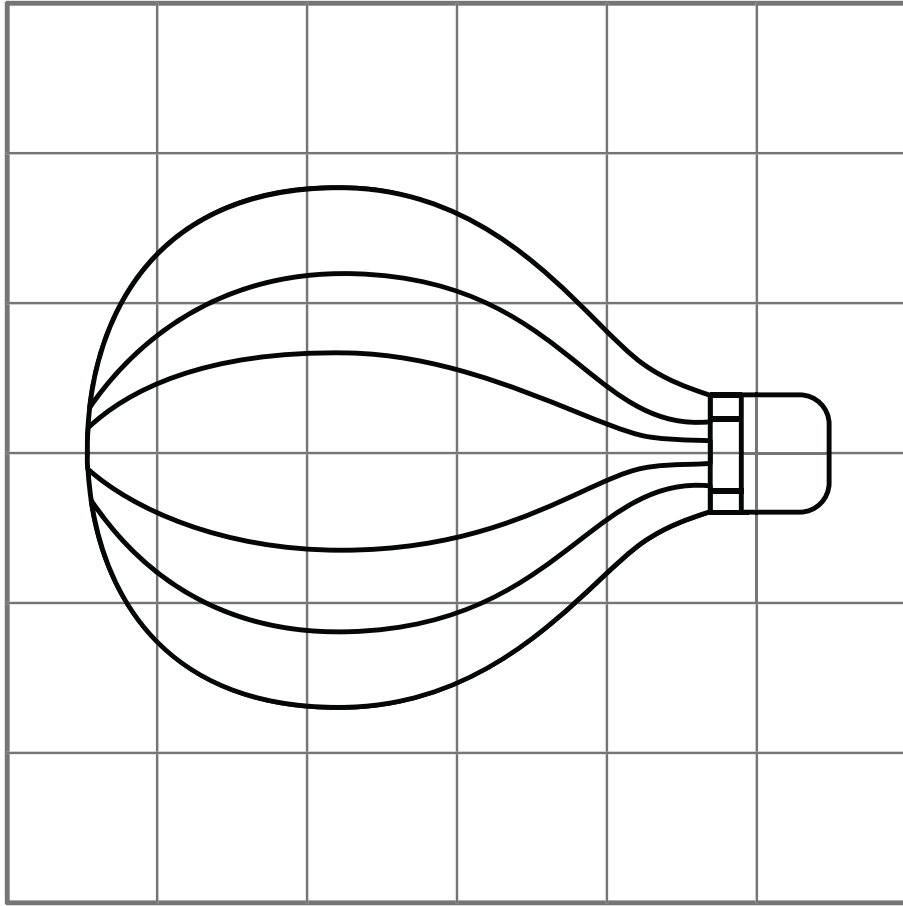
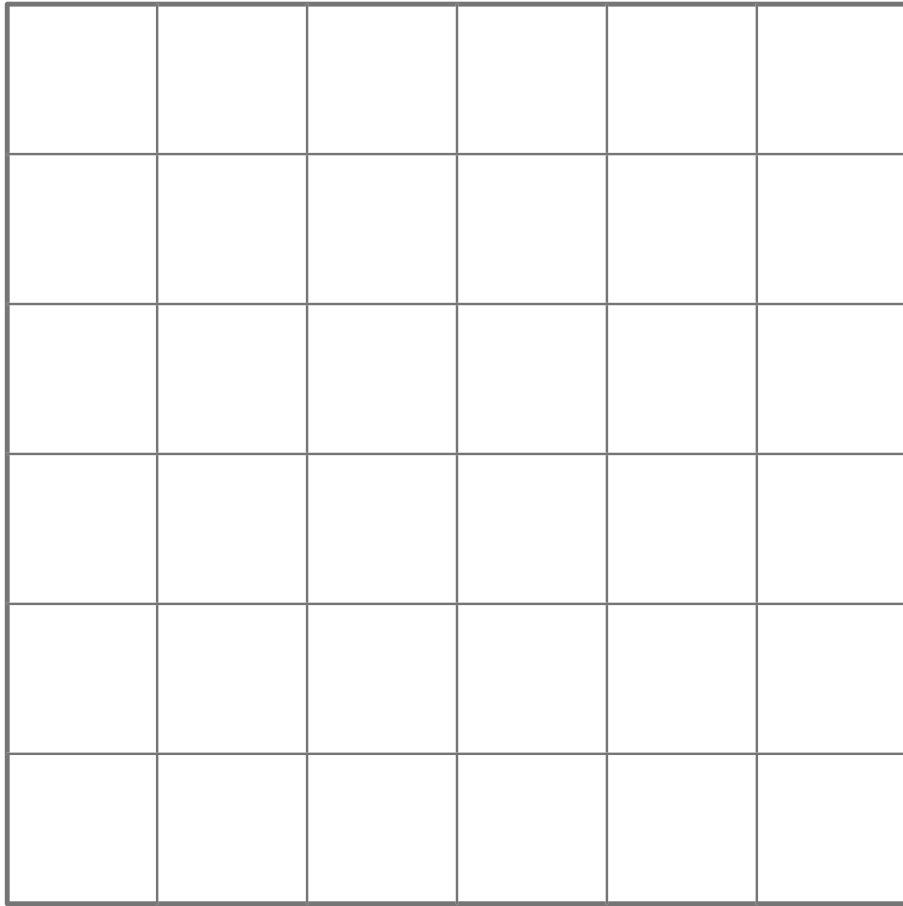

DRAWING

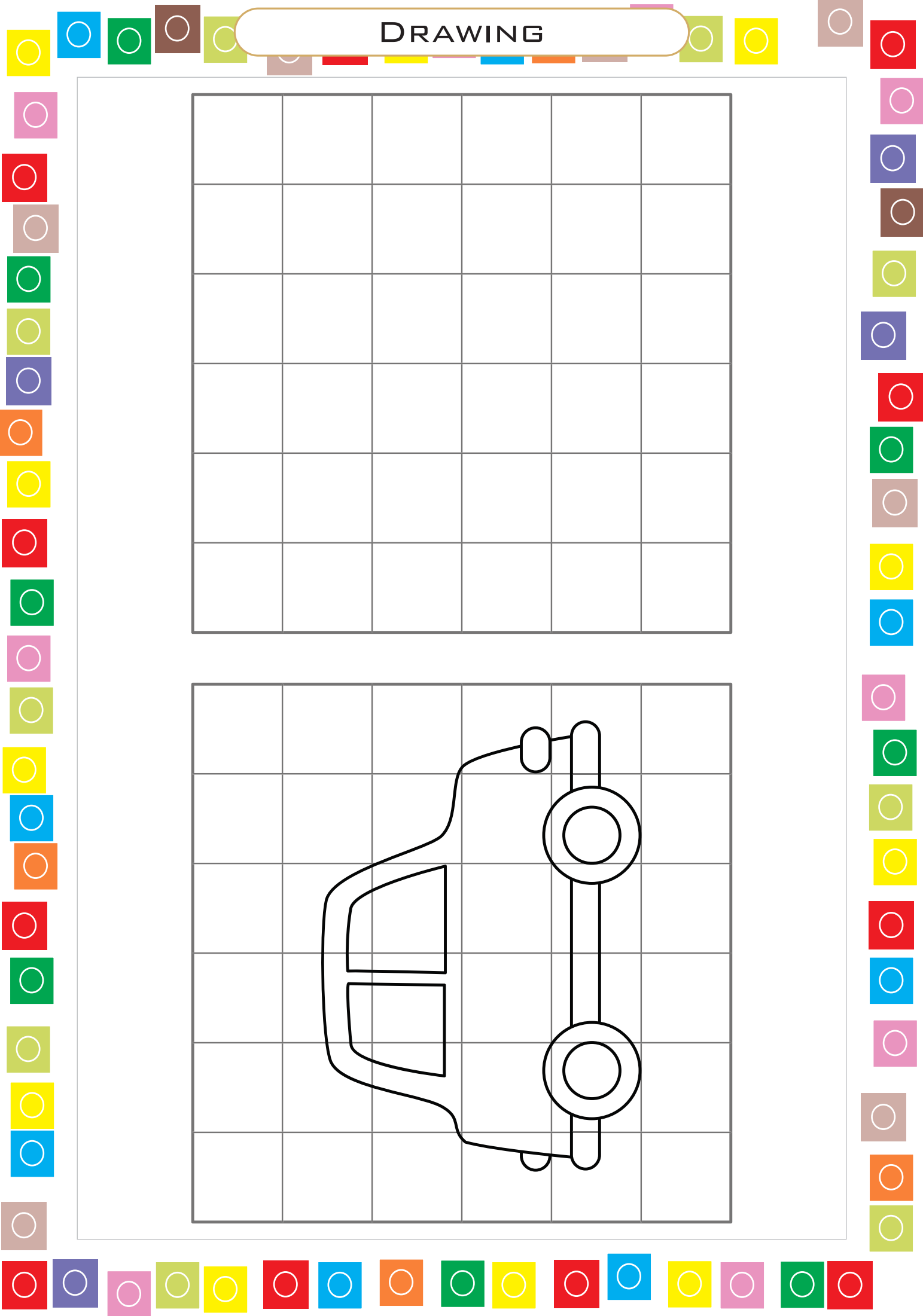
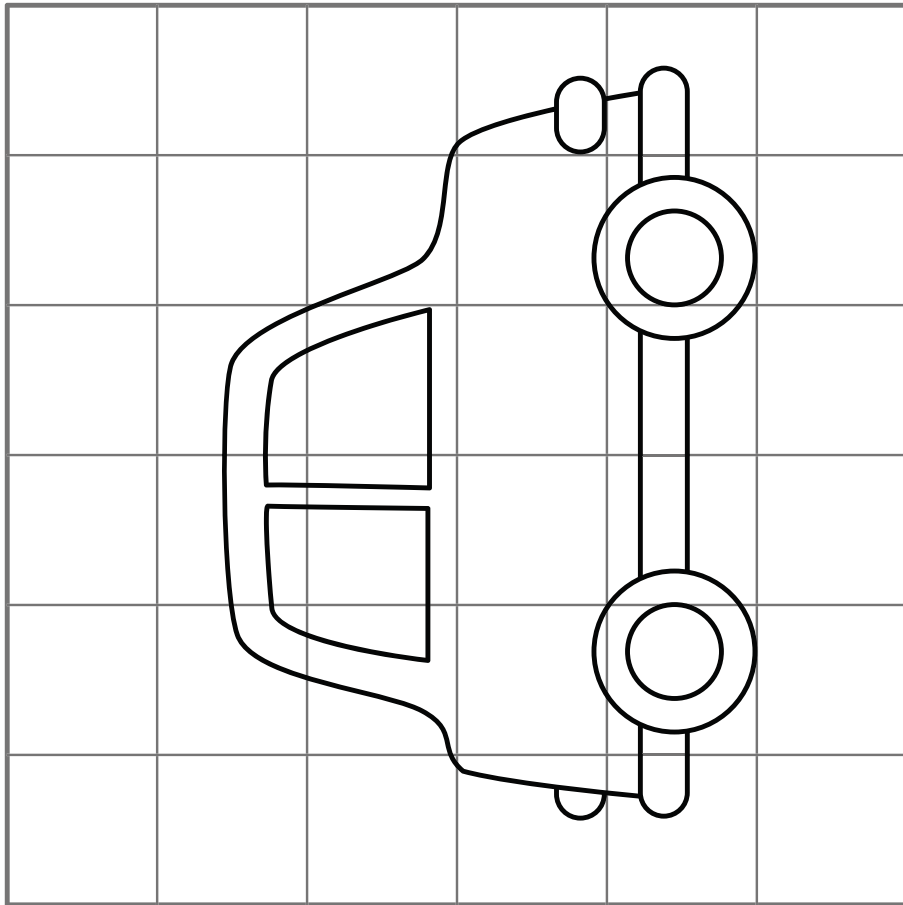
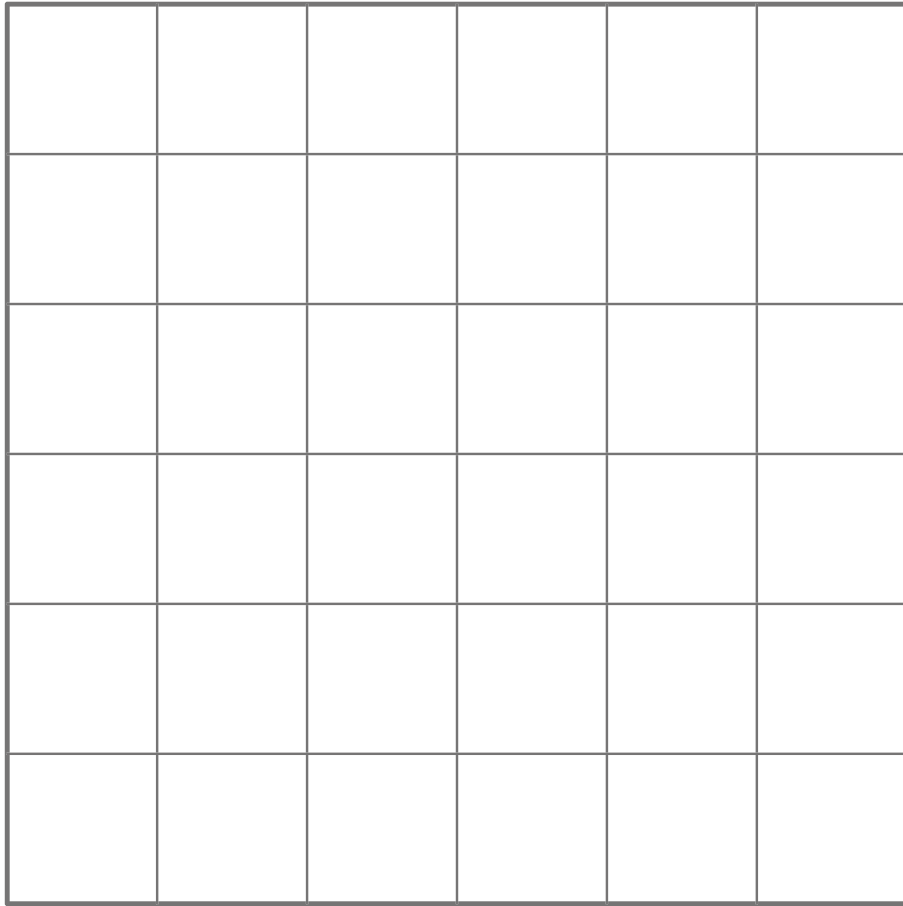

DRAWING

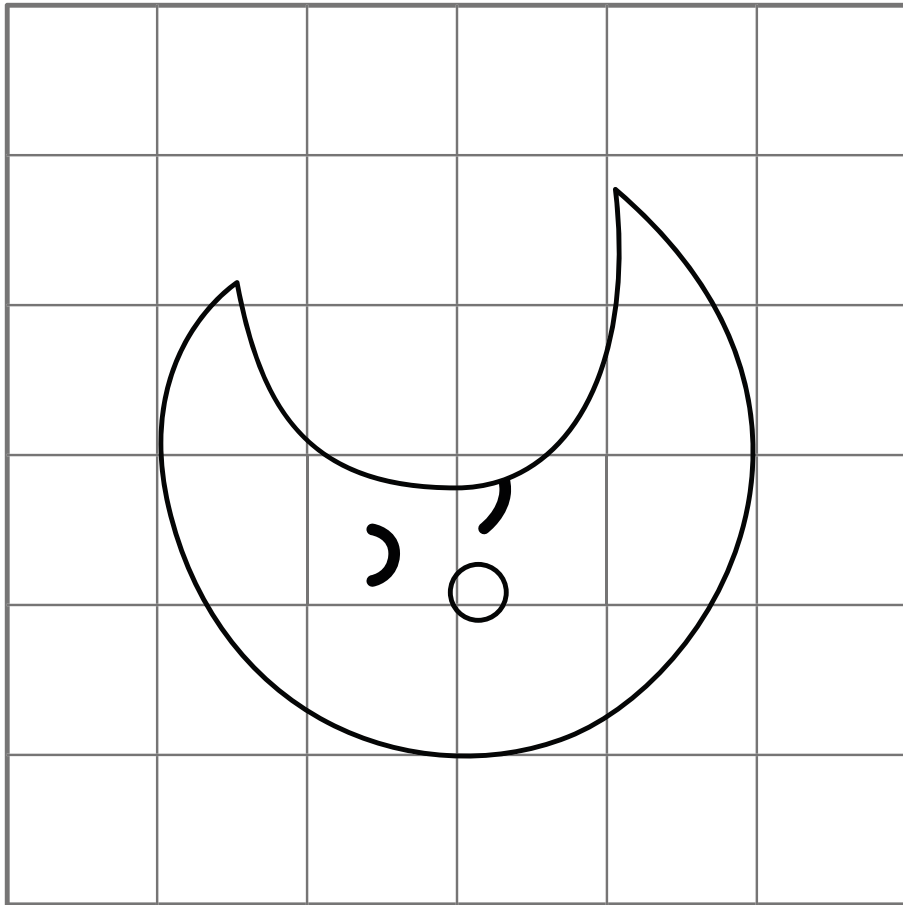
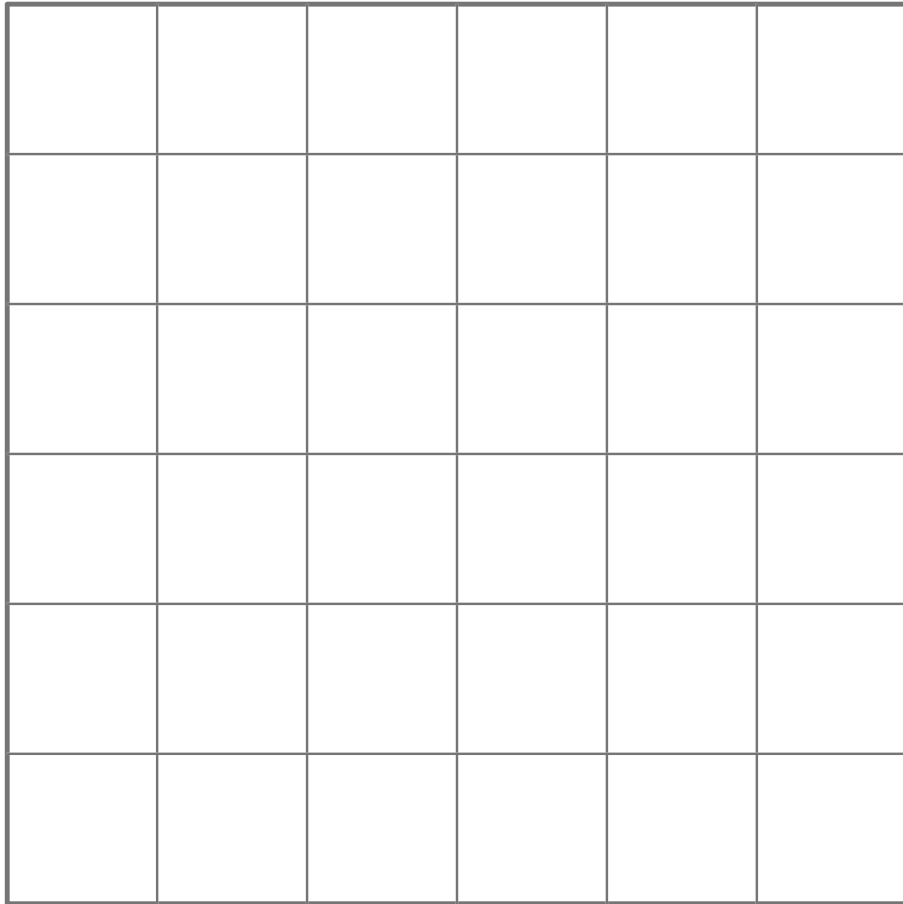

DRAWING

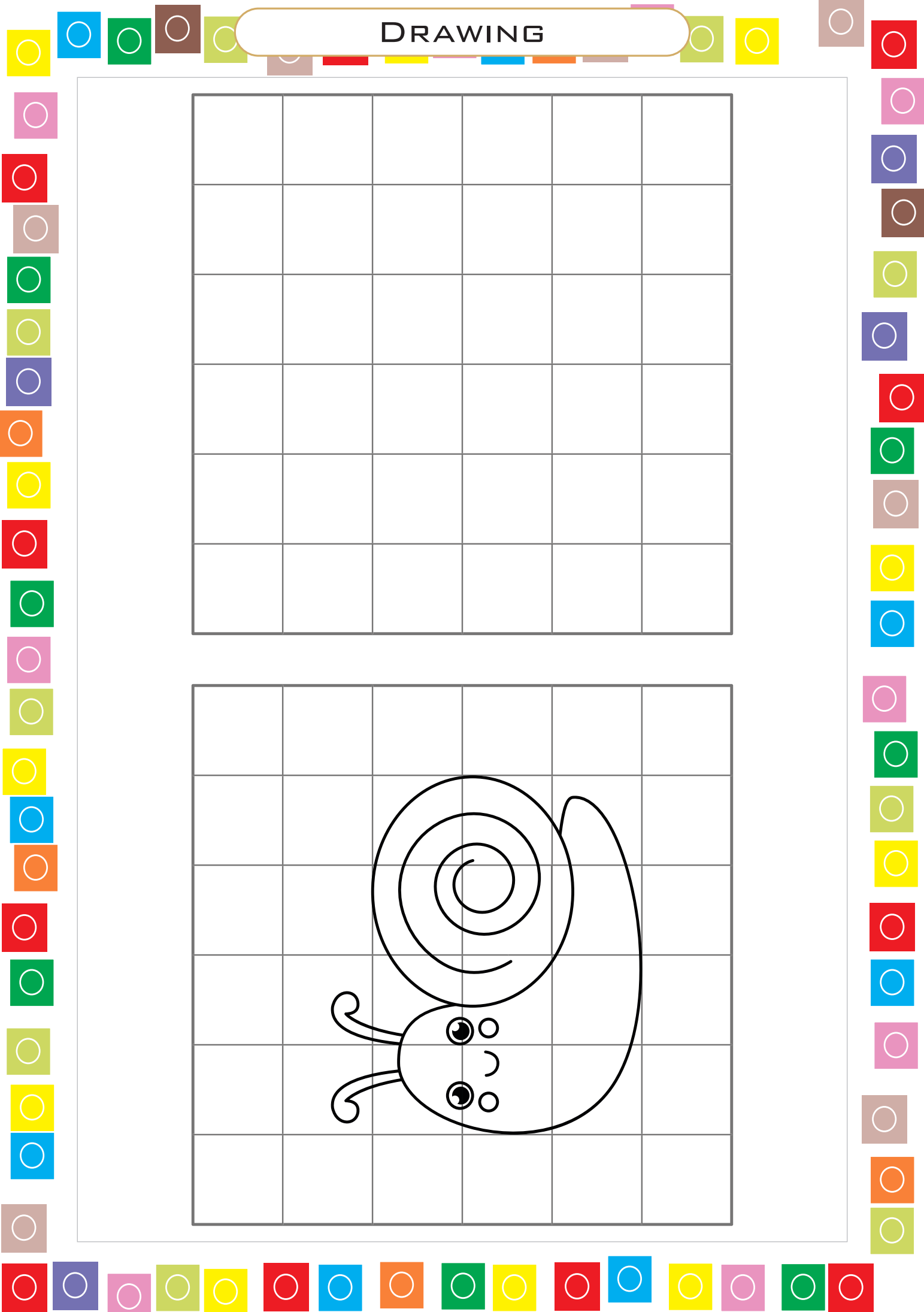
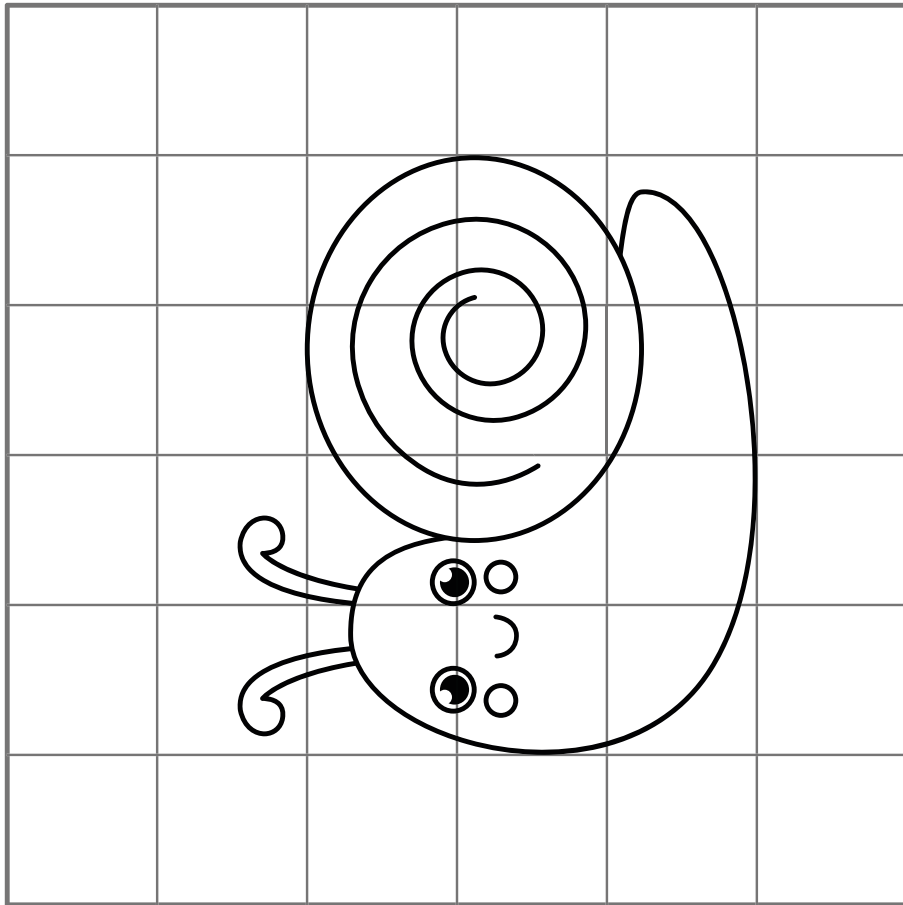
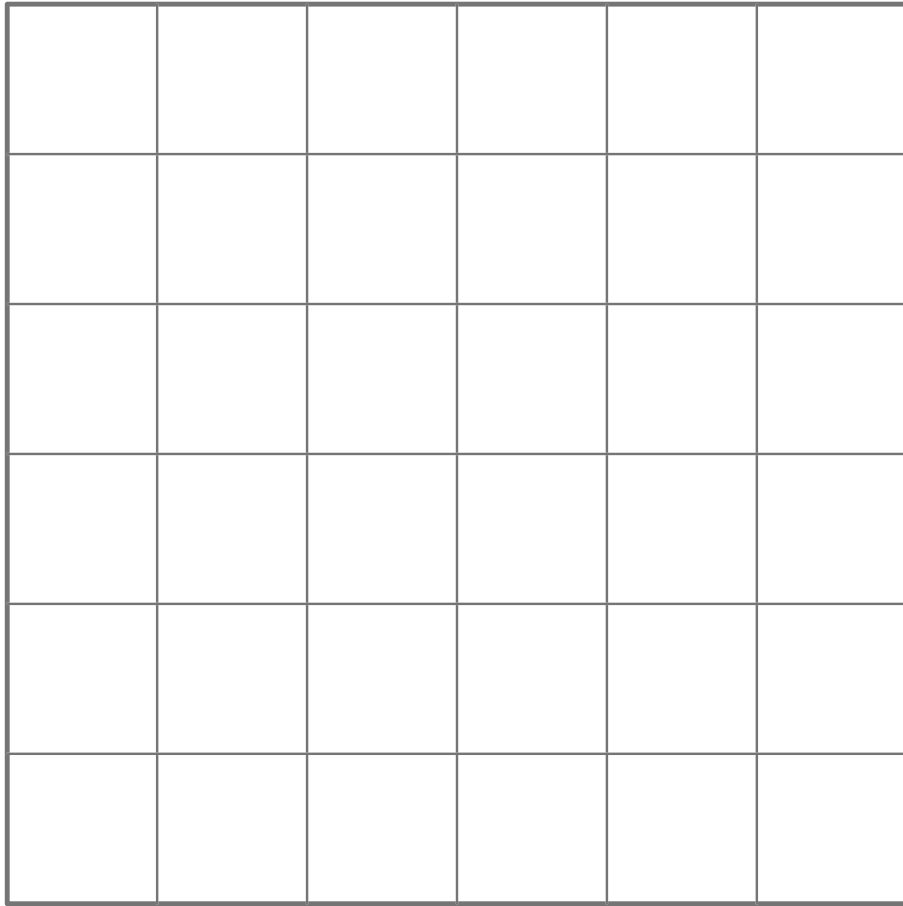

DRAWING

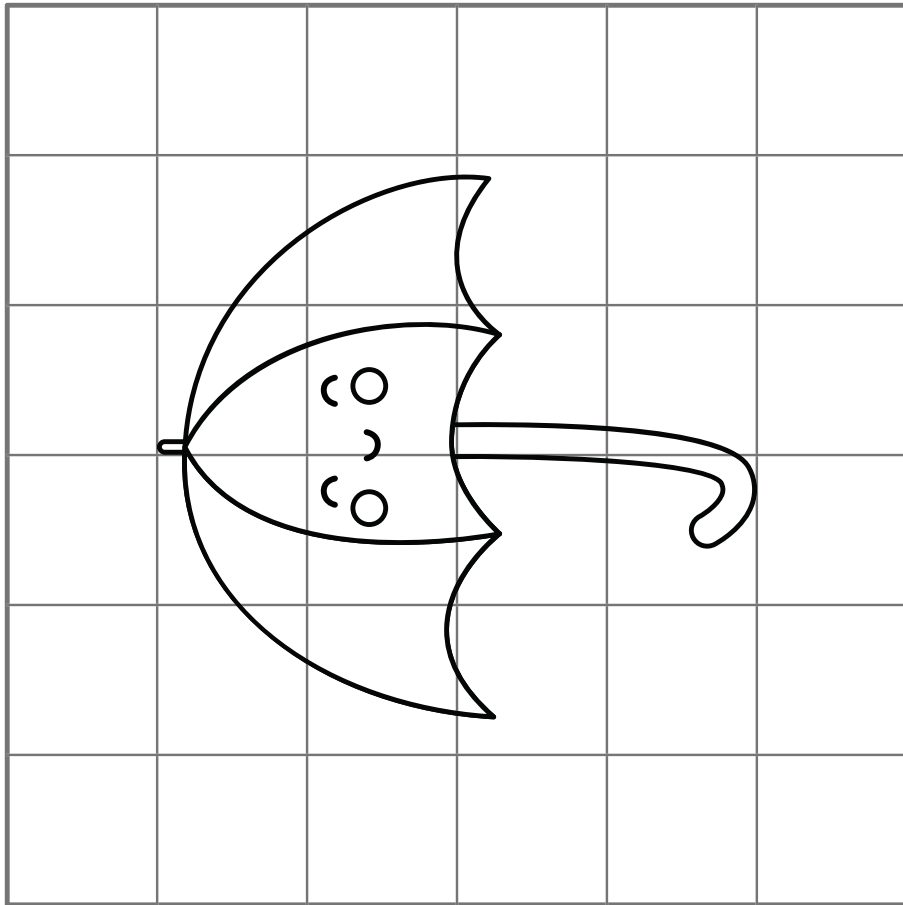
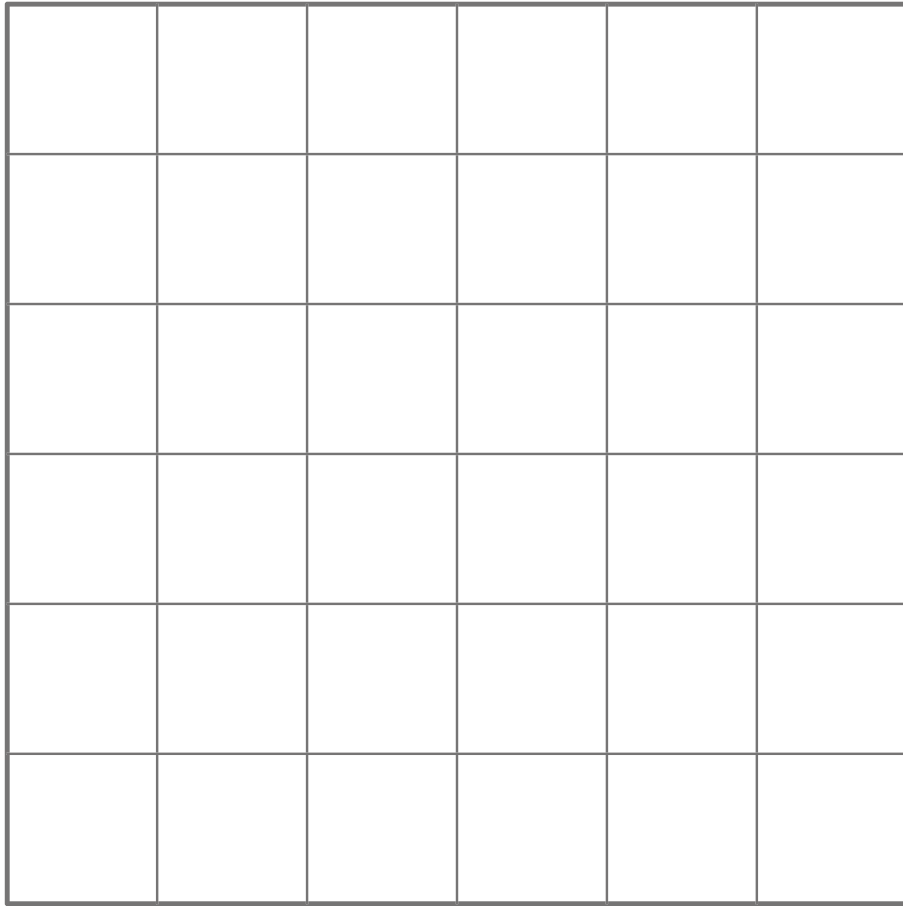

DRAWING

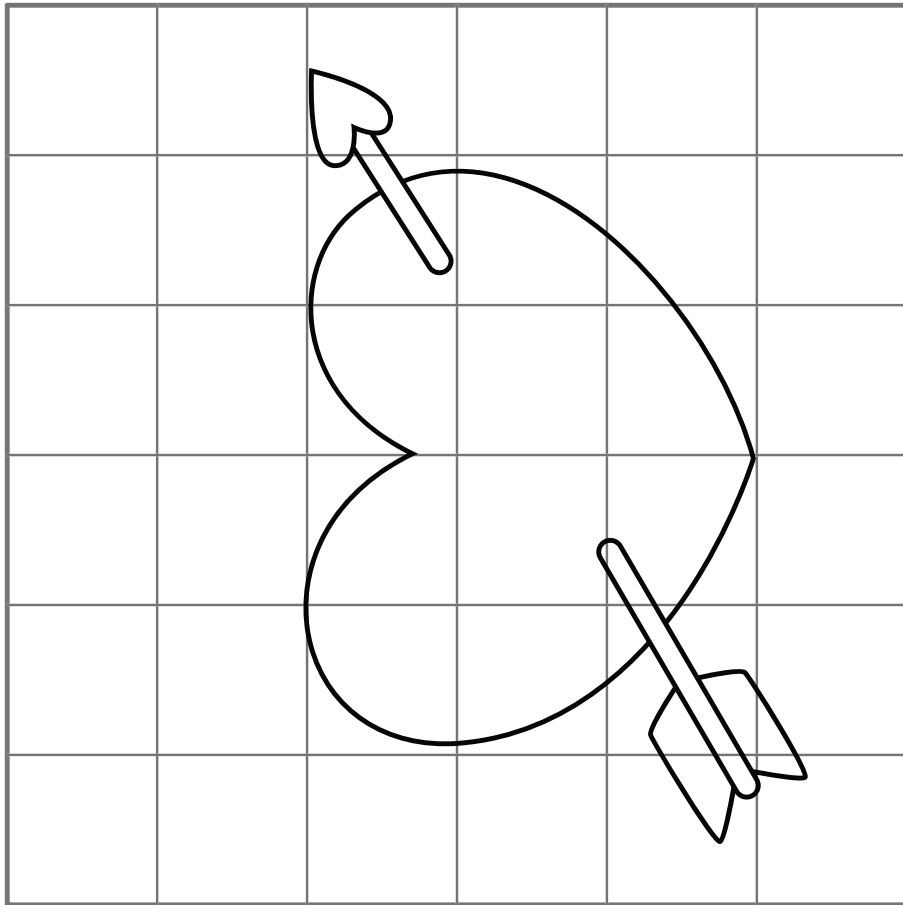
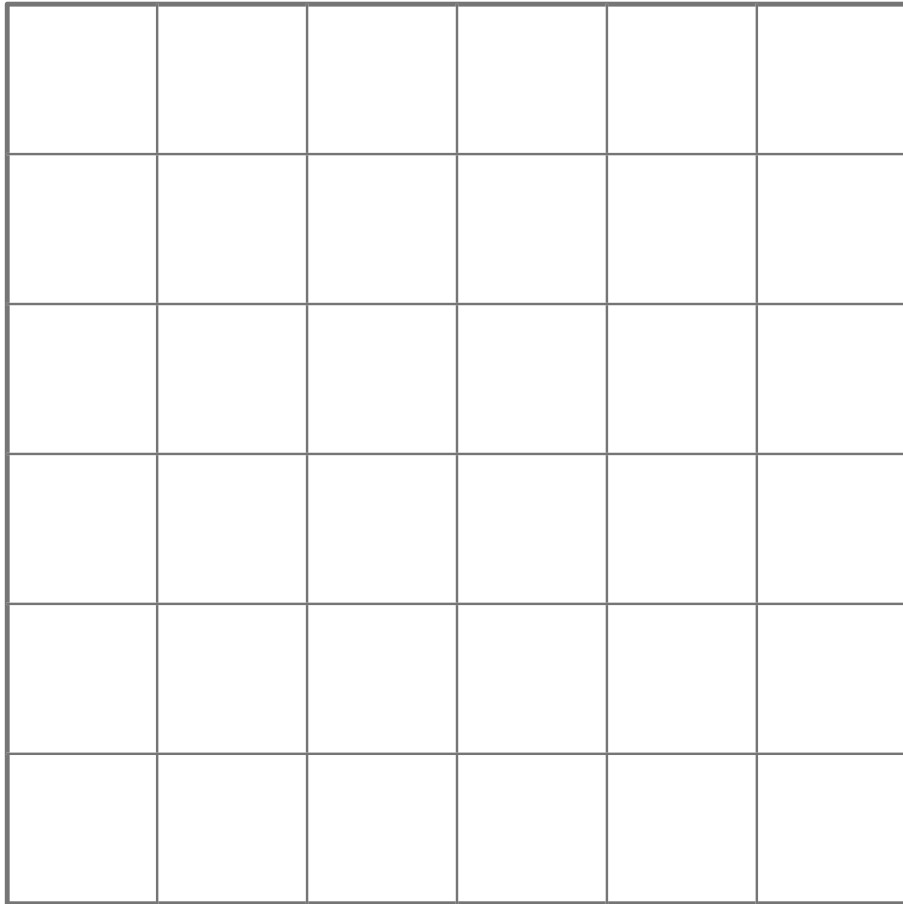

DRAWING

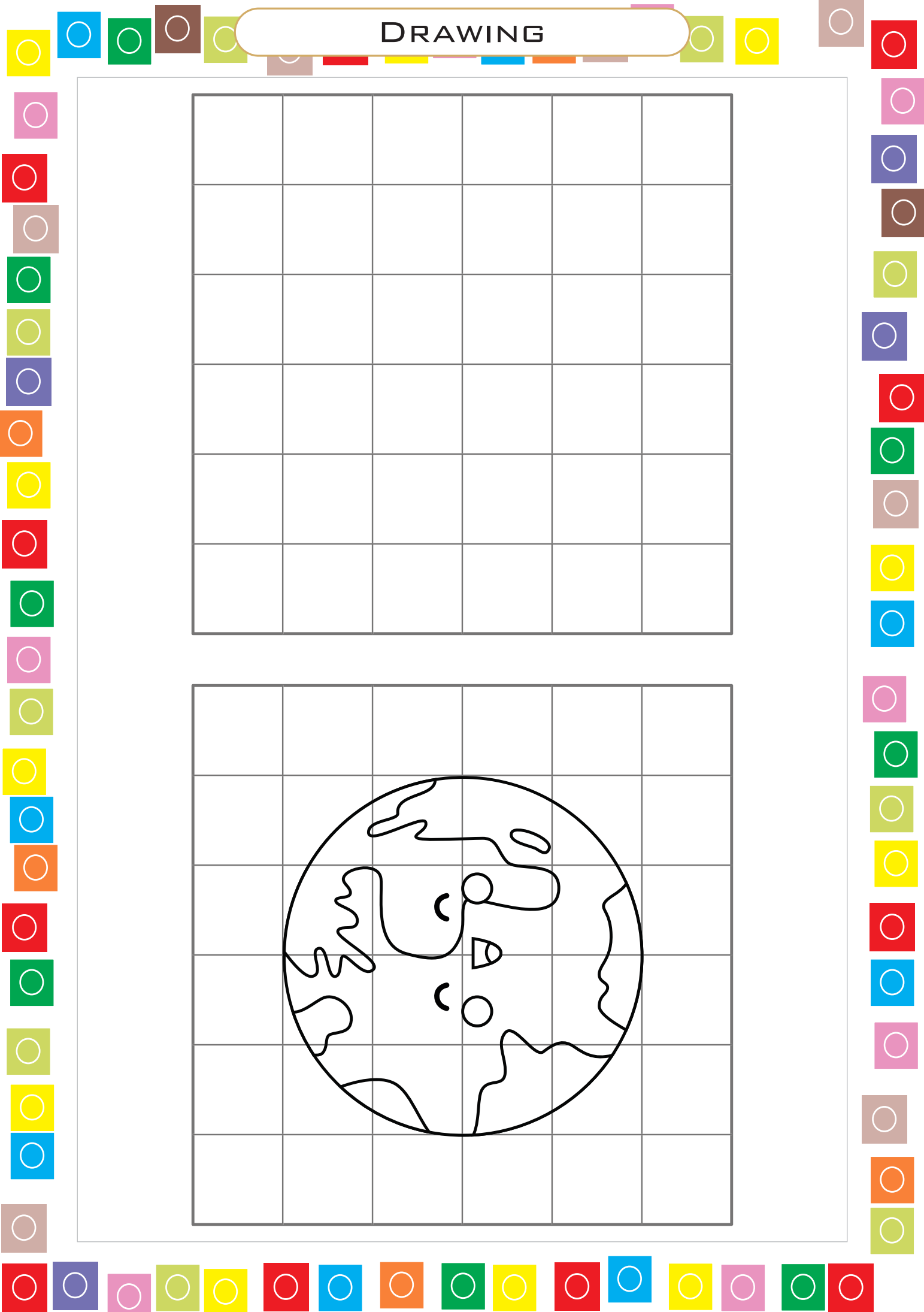
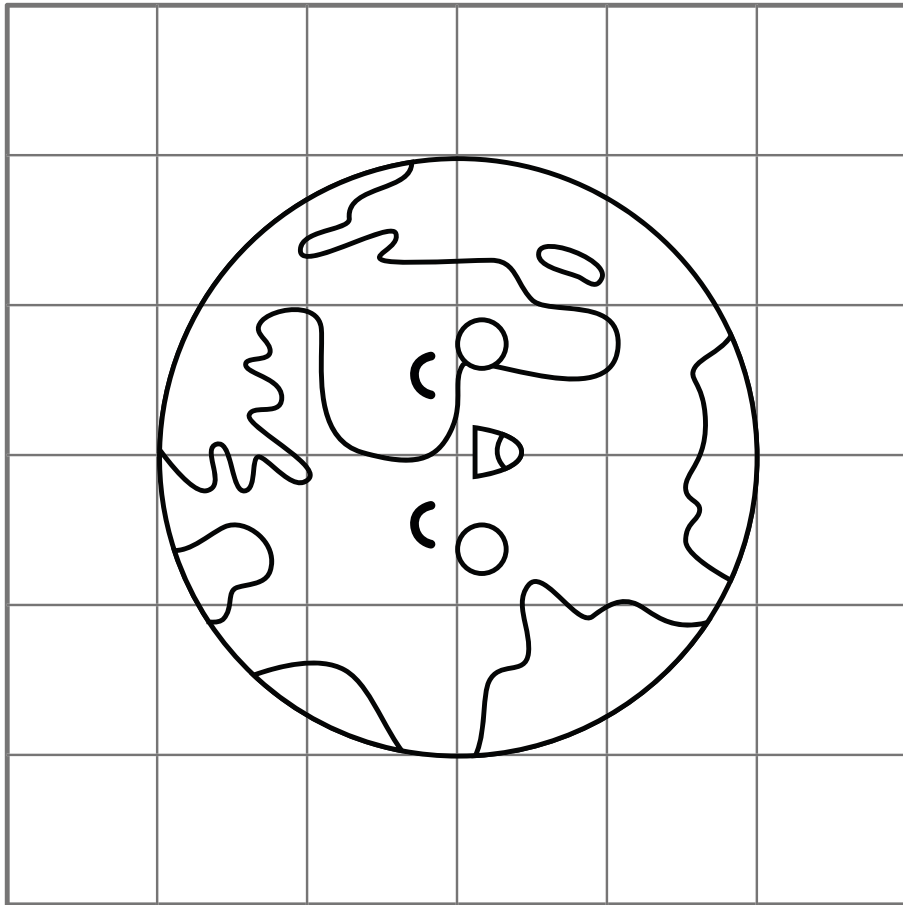
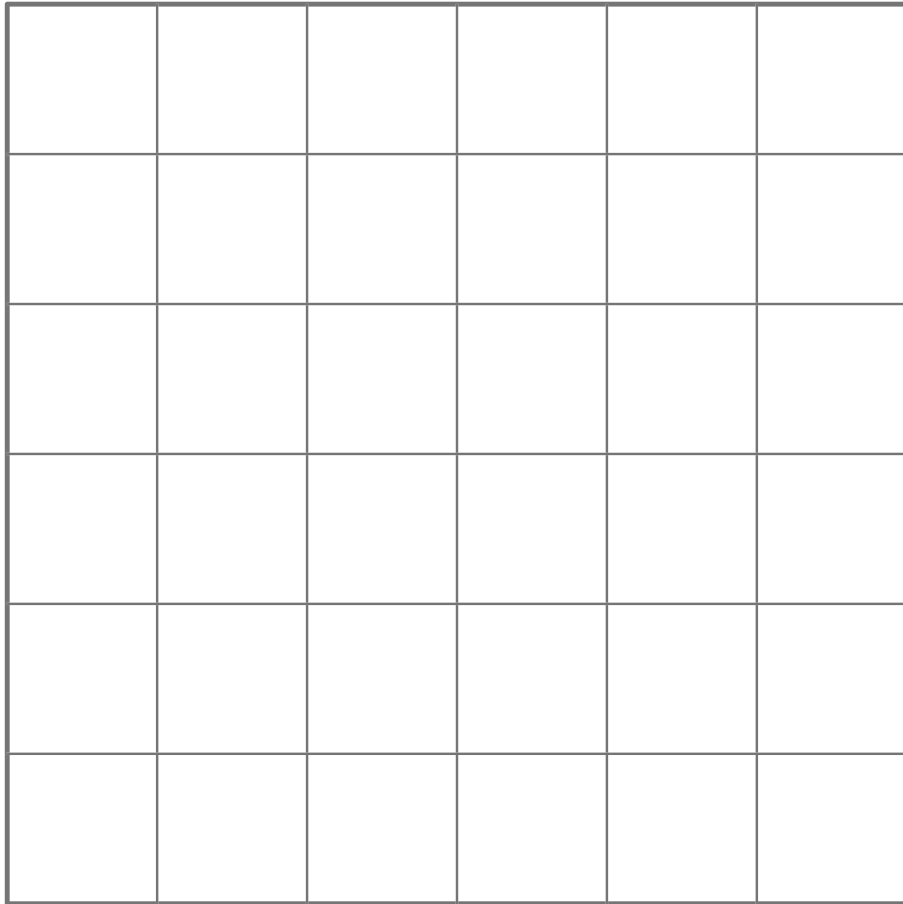

DRAWING

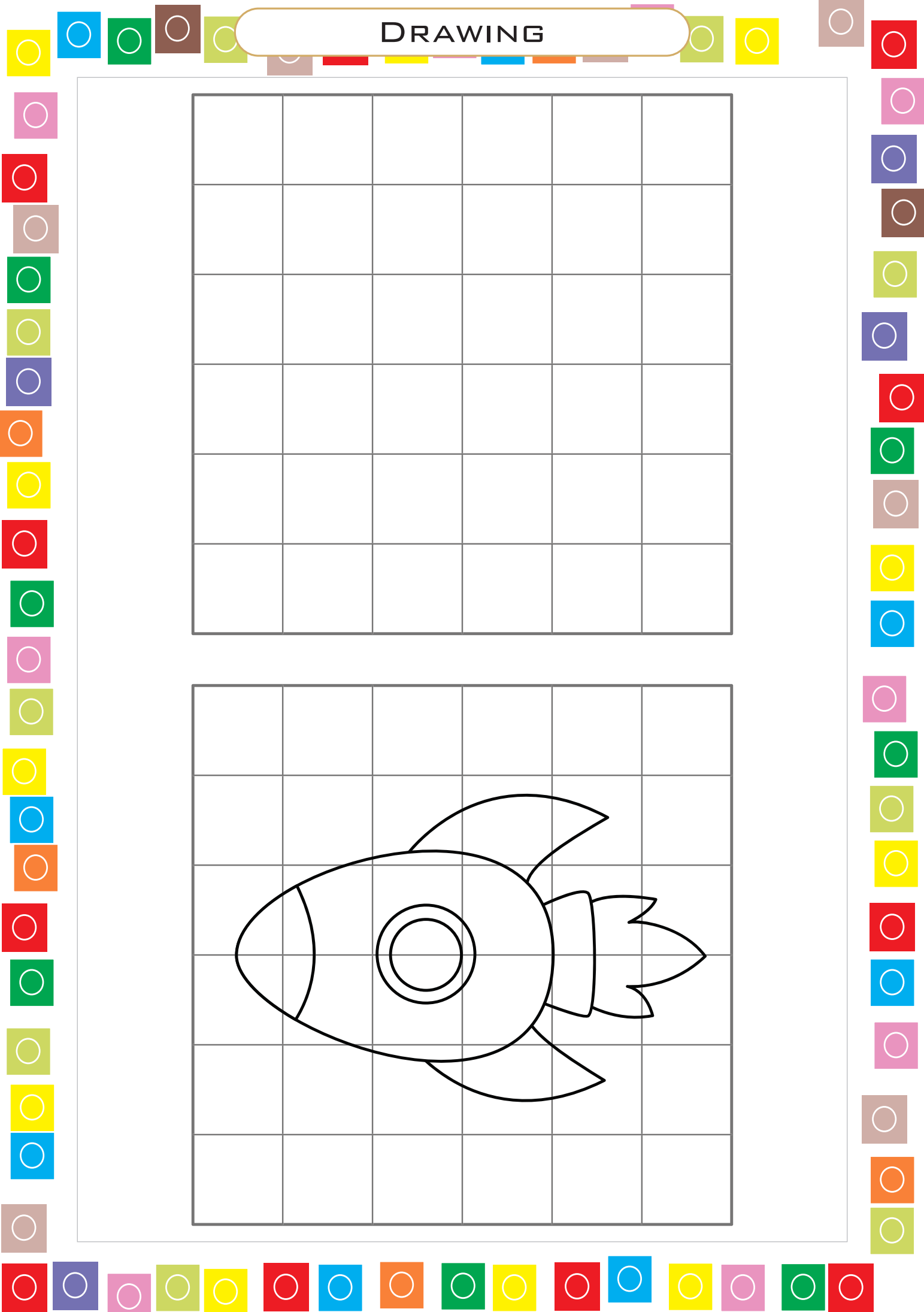
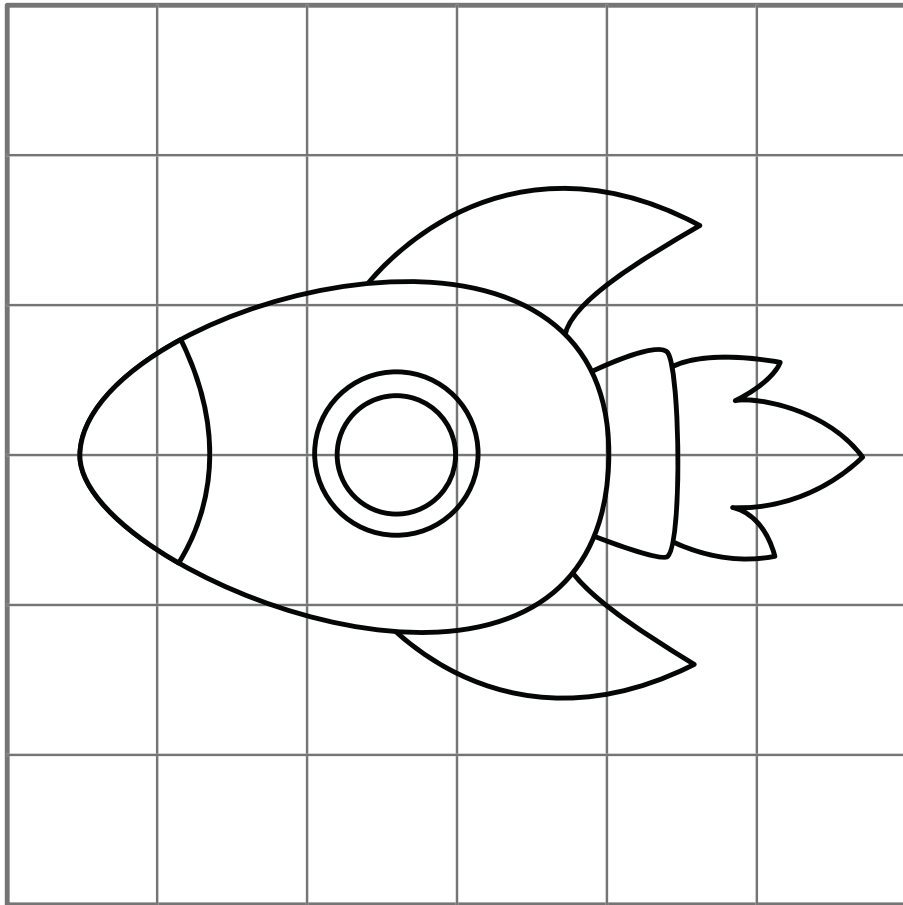
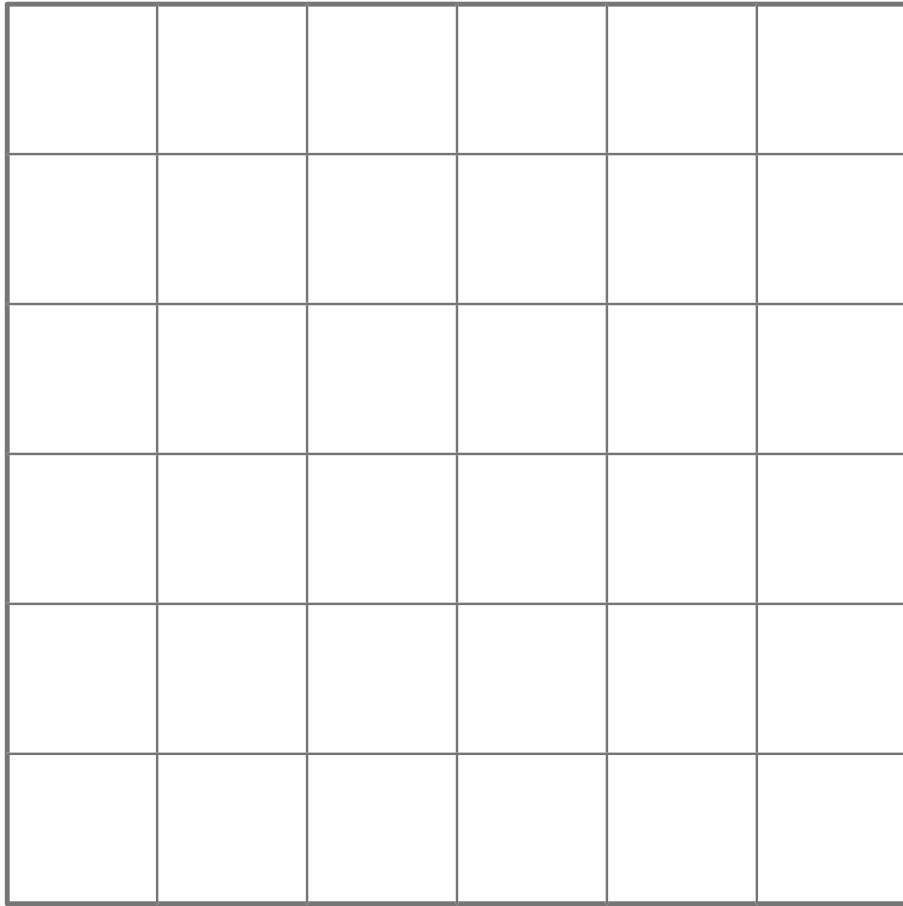

DRAWING

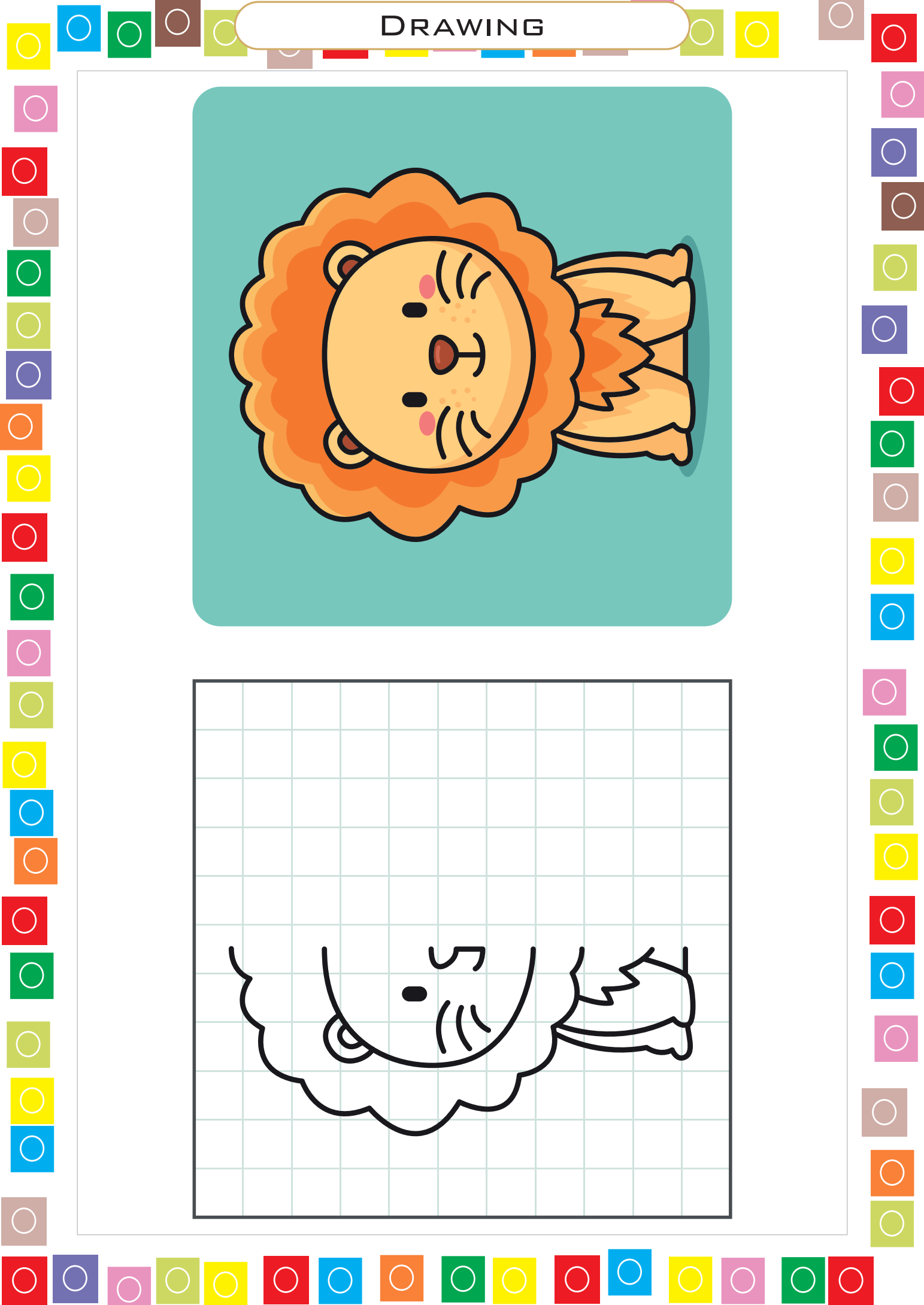
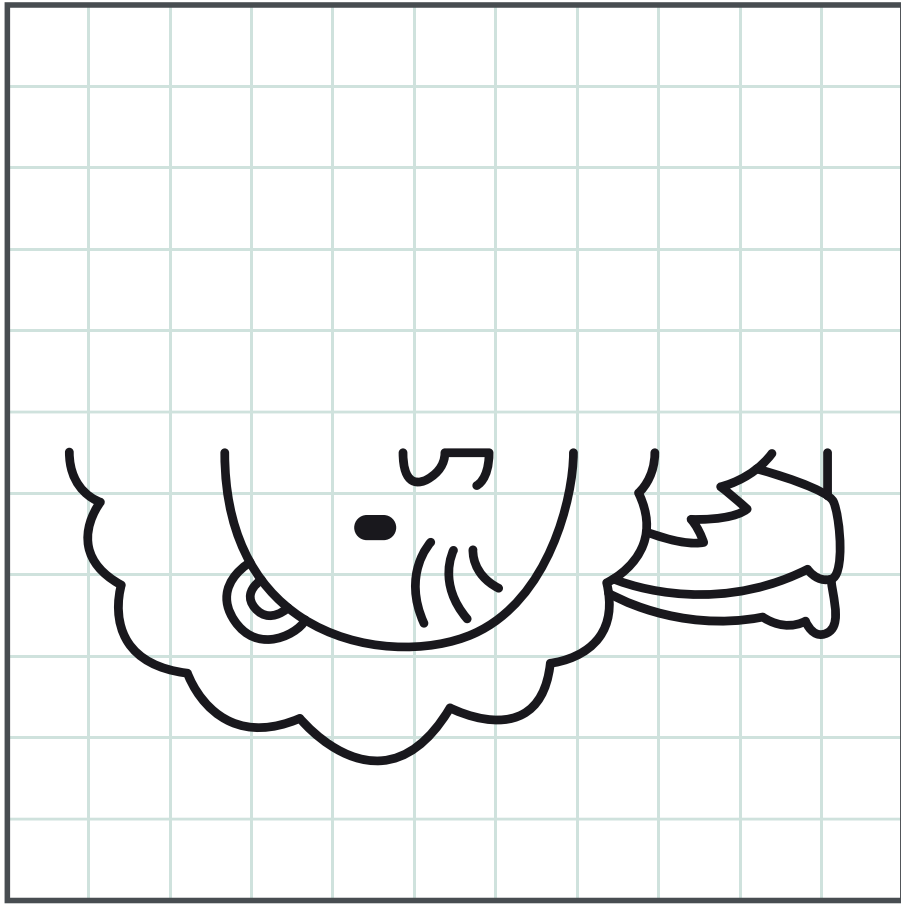
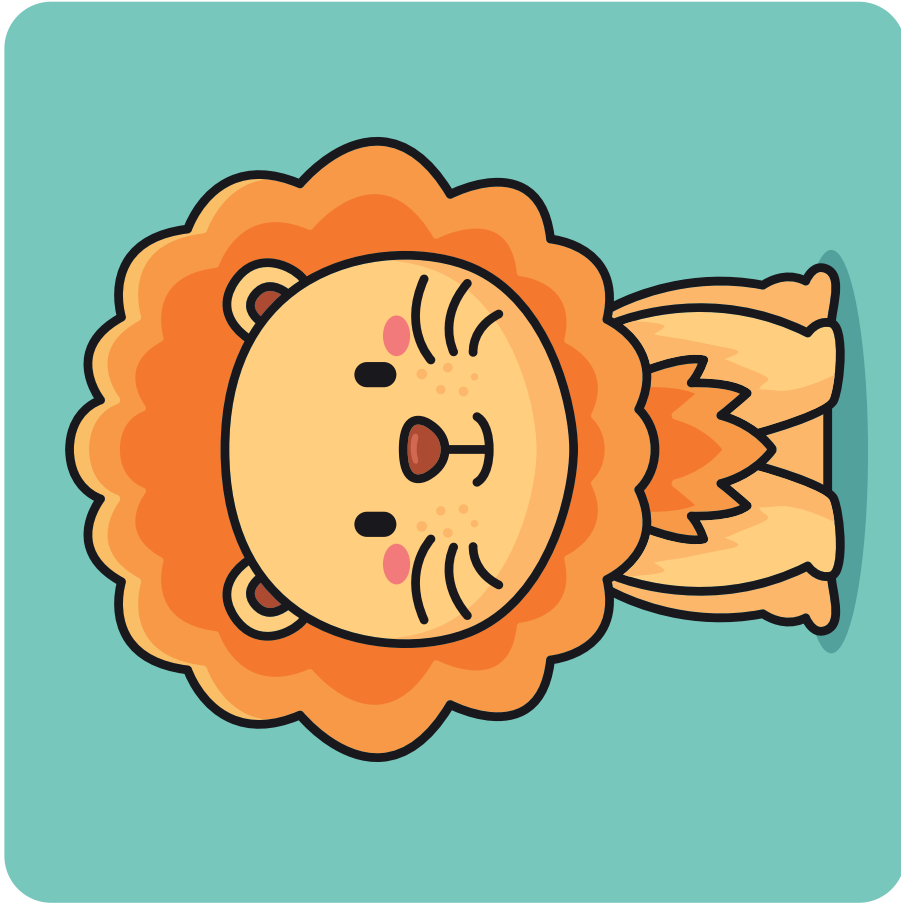

DRAWING

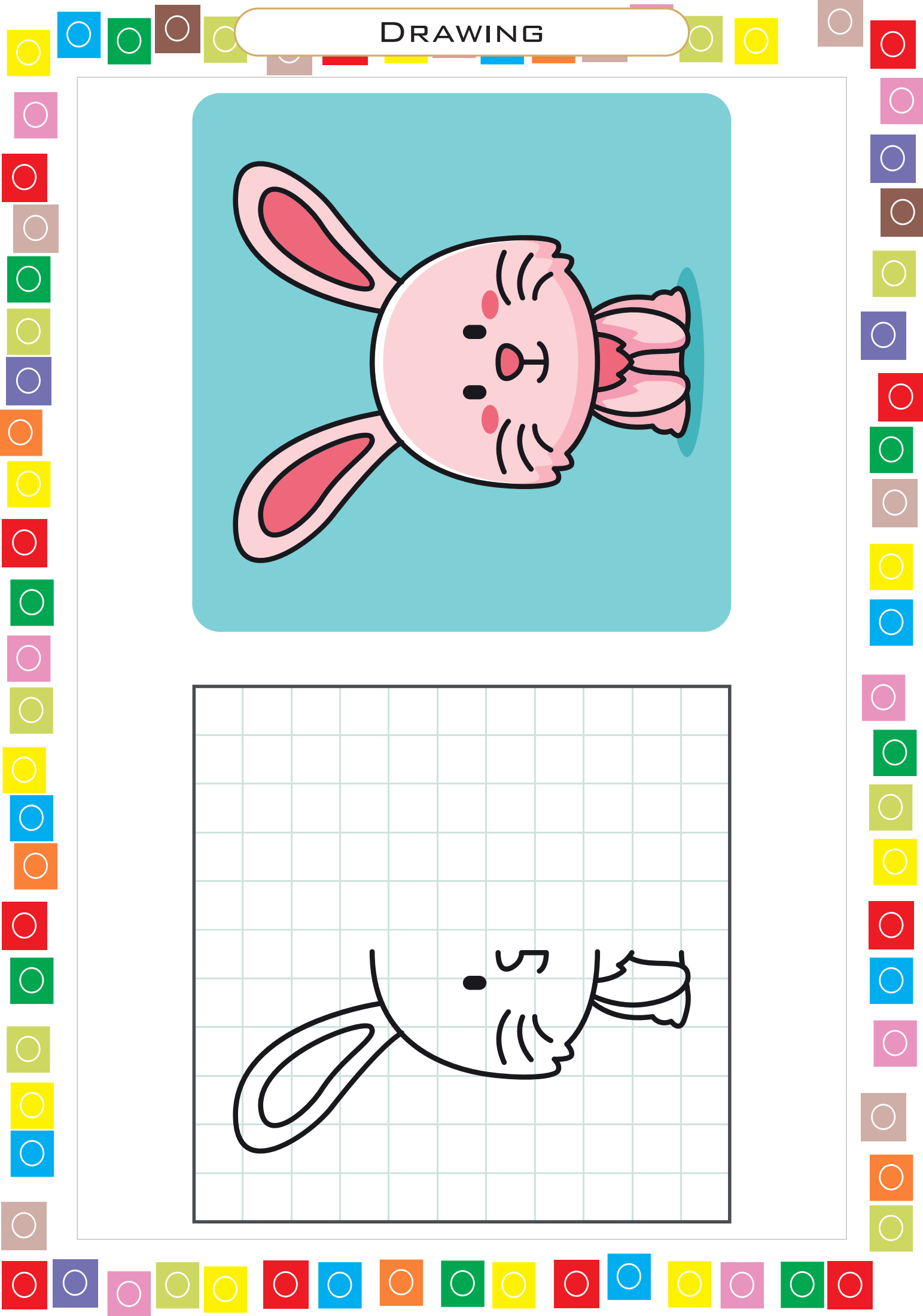
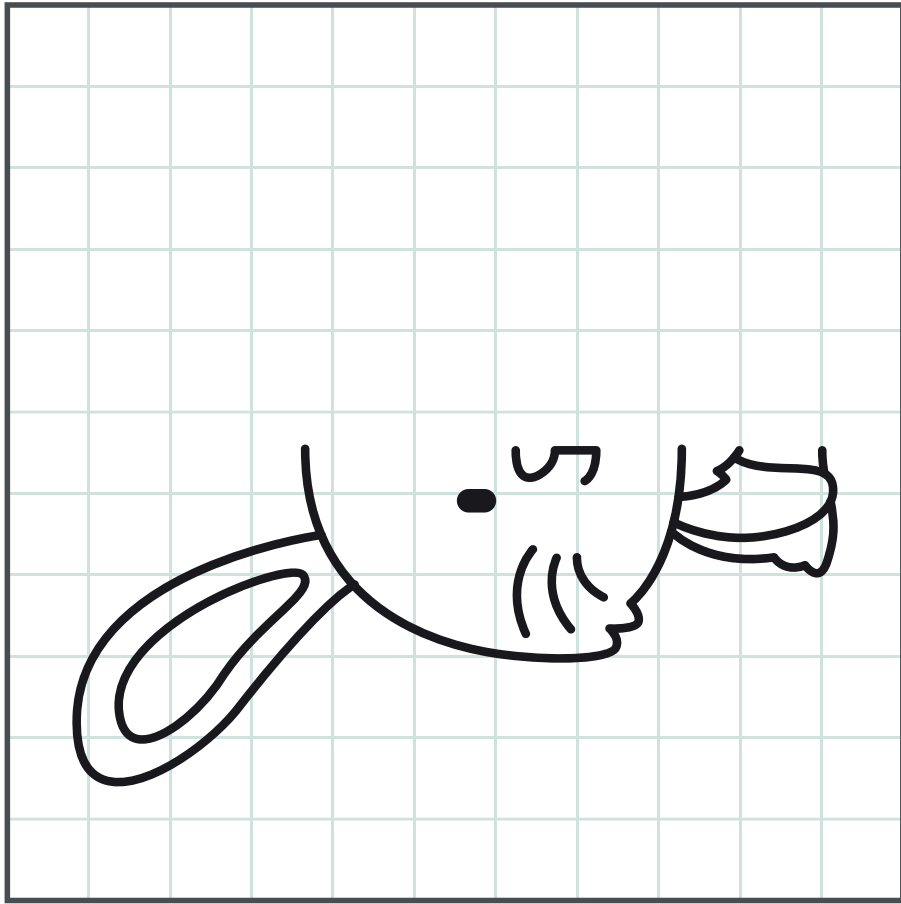
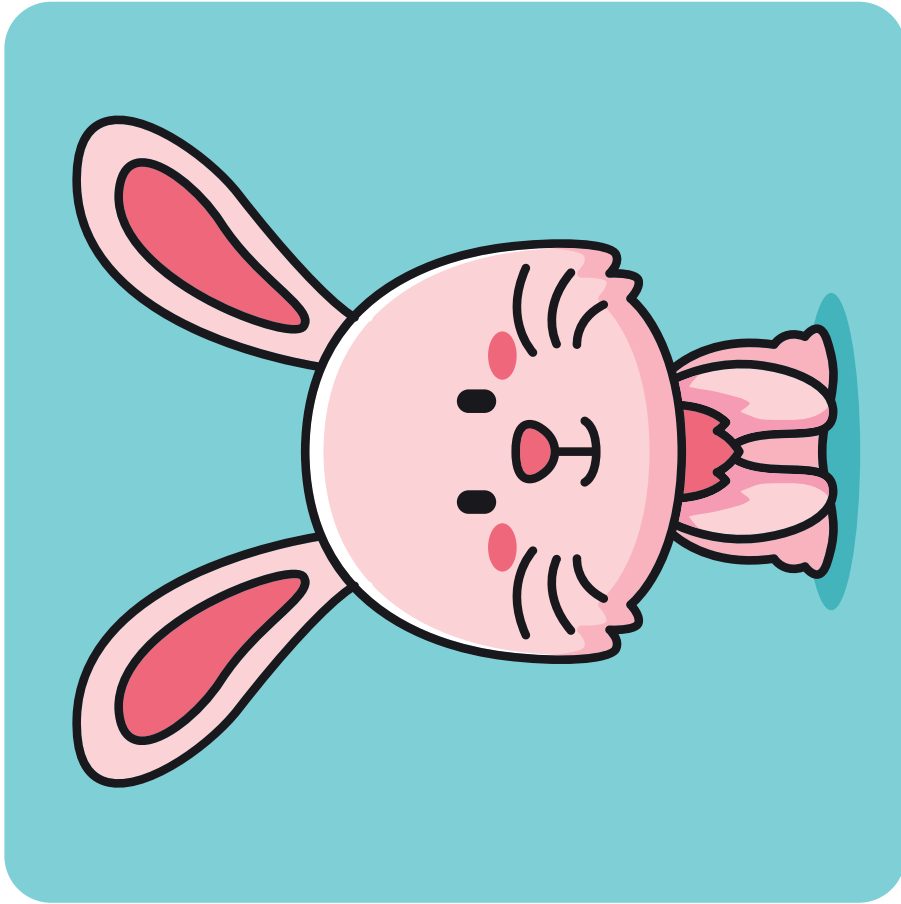

DRAWING

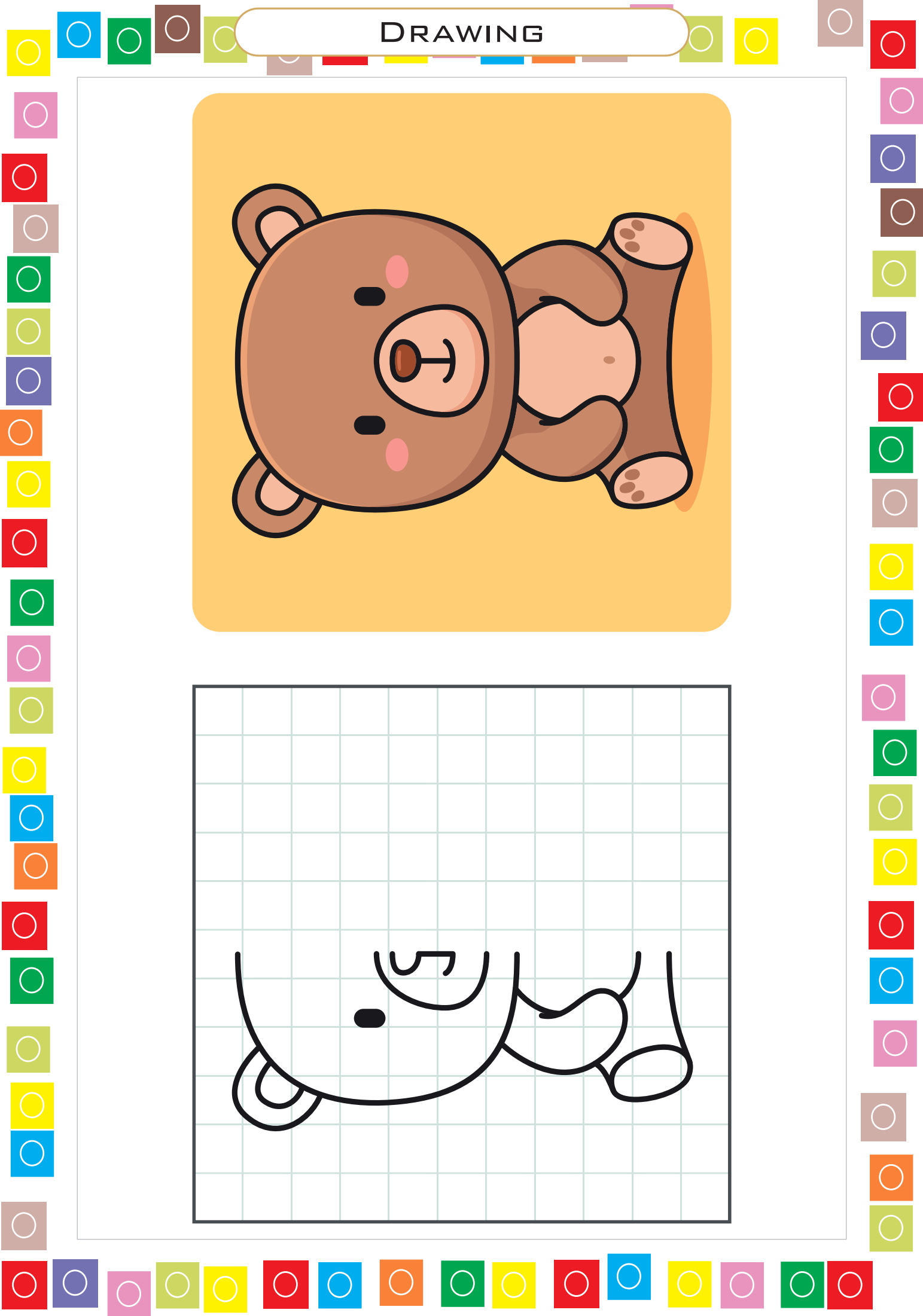
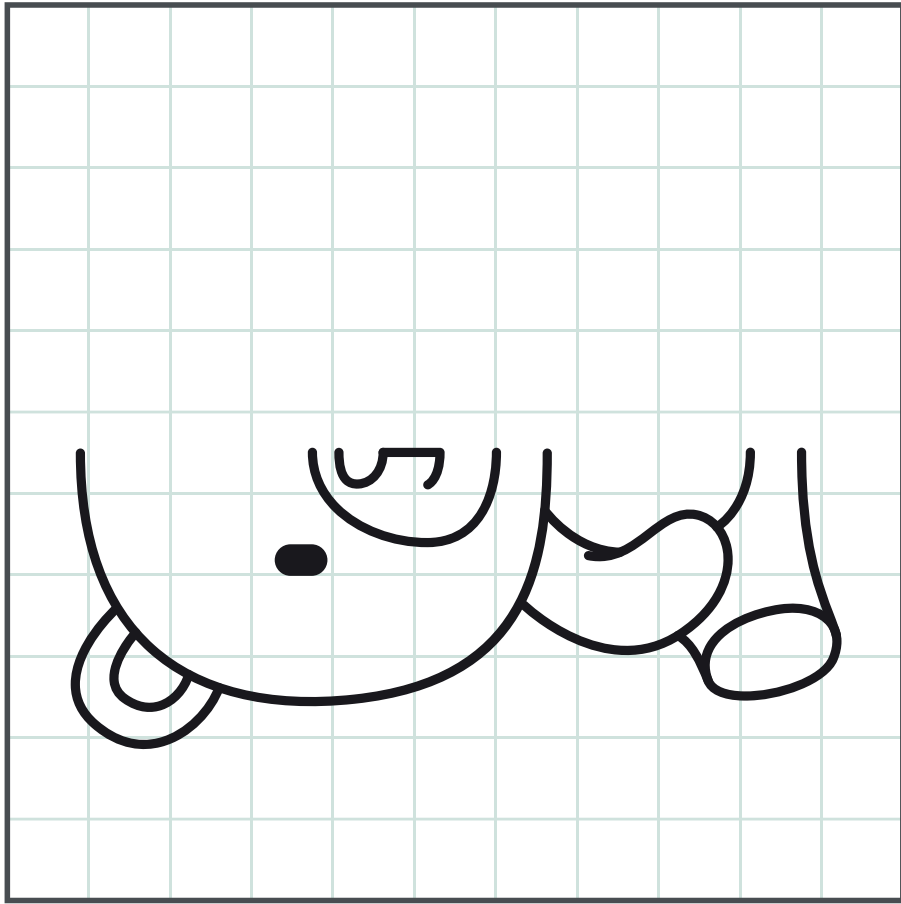

DRAWING

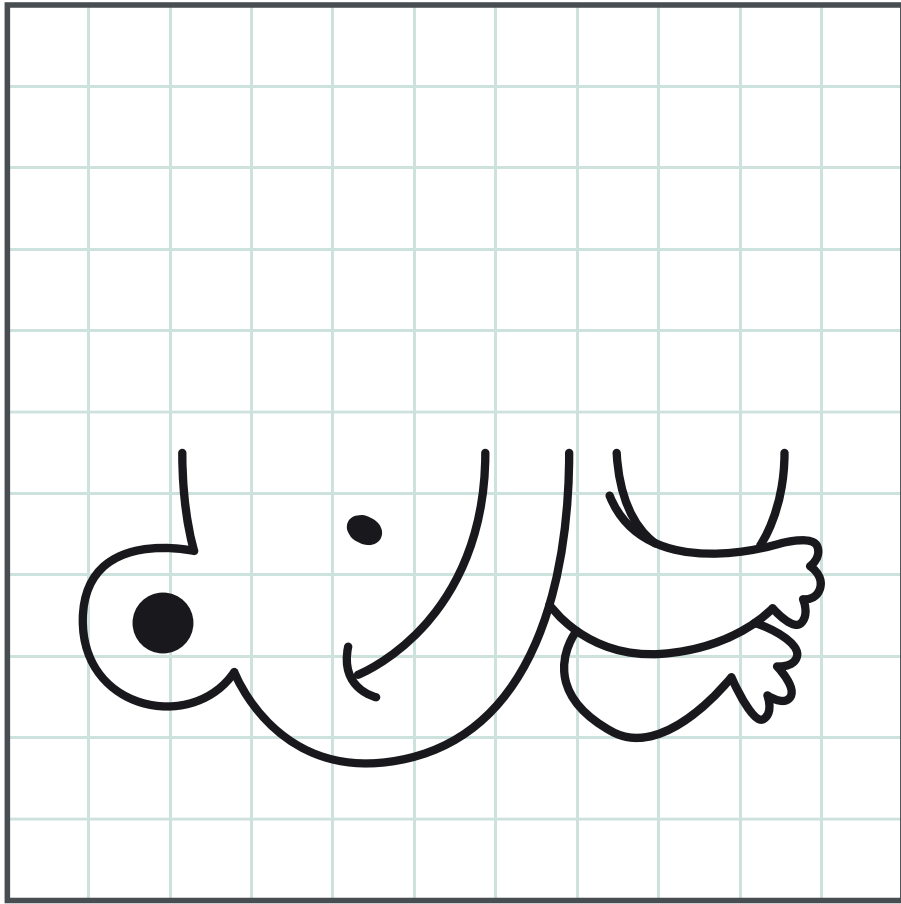
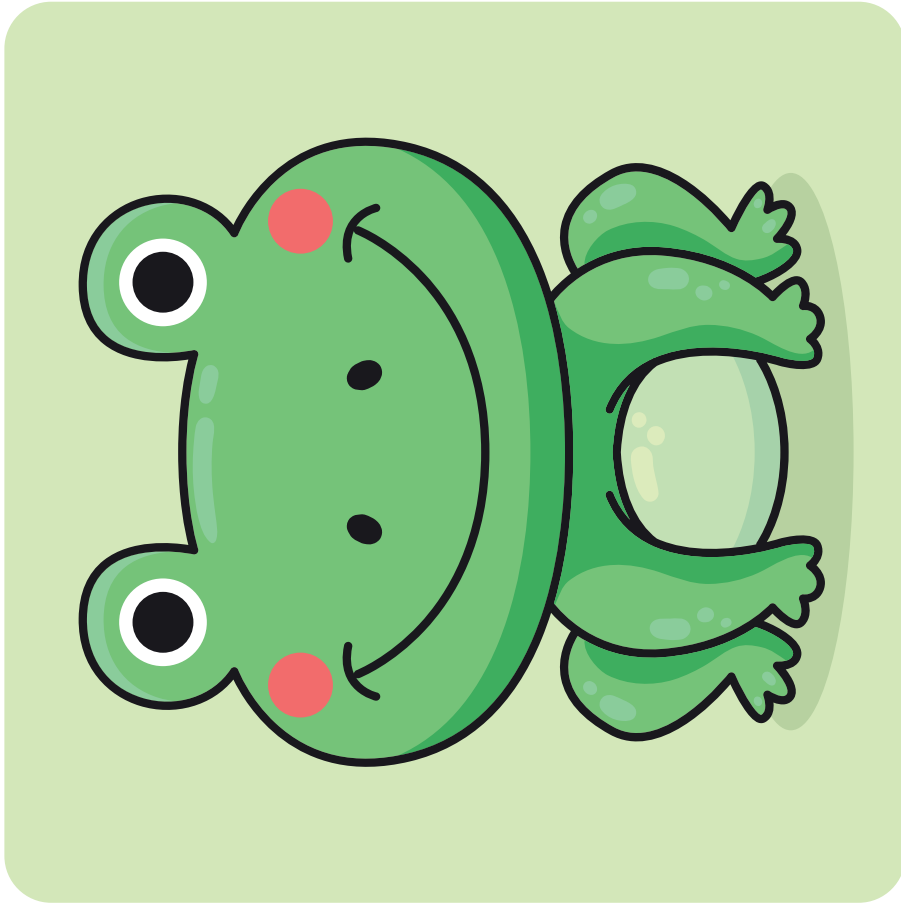

DRAWING

