

The 100 Best

Connect the dots

WorkSheets

For Kids

(A4 Printable)



CONNECT THE DOTS

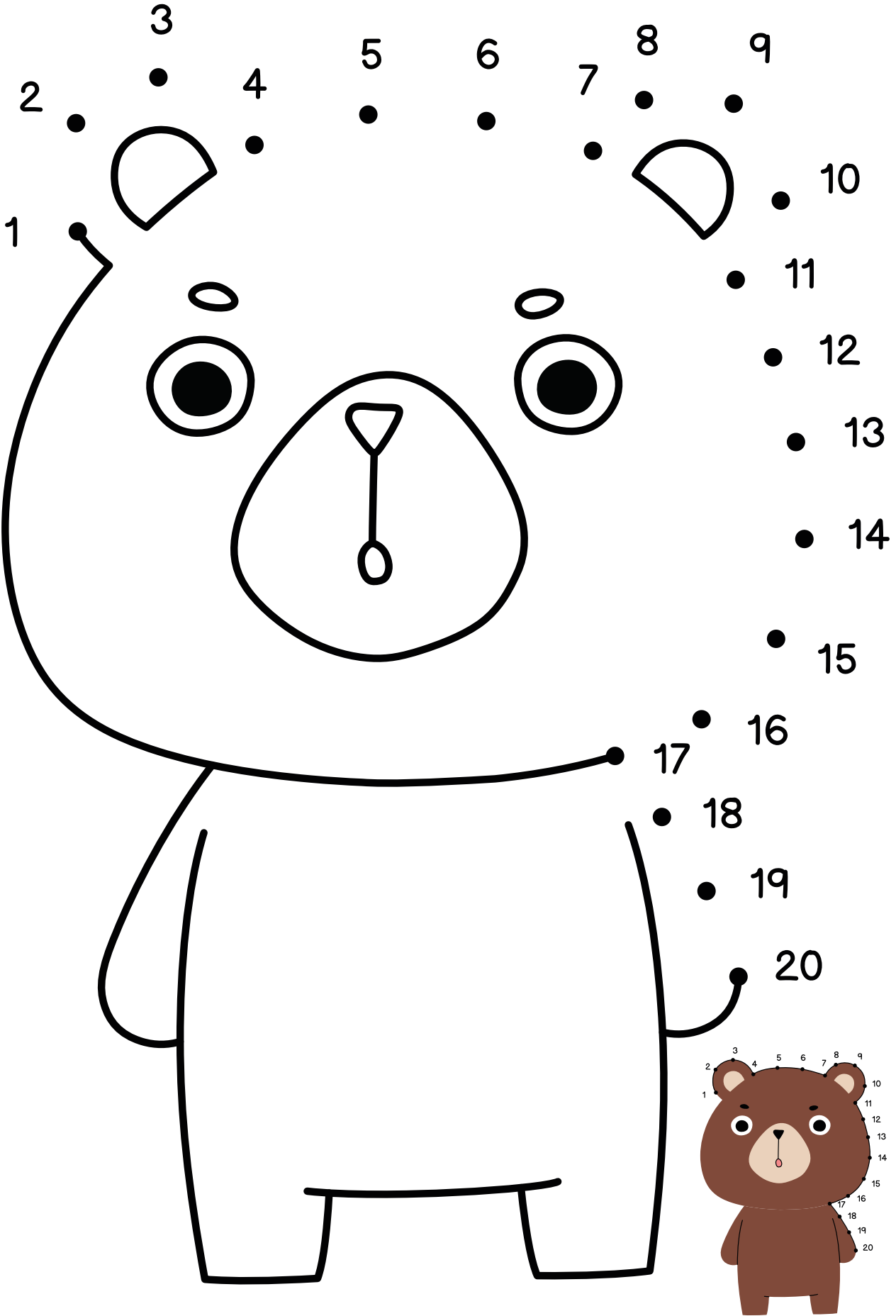

CONNECT THE DOTS

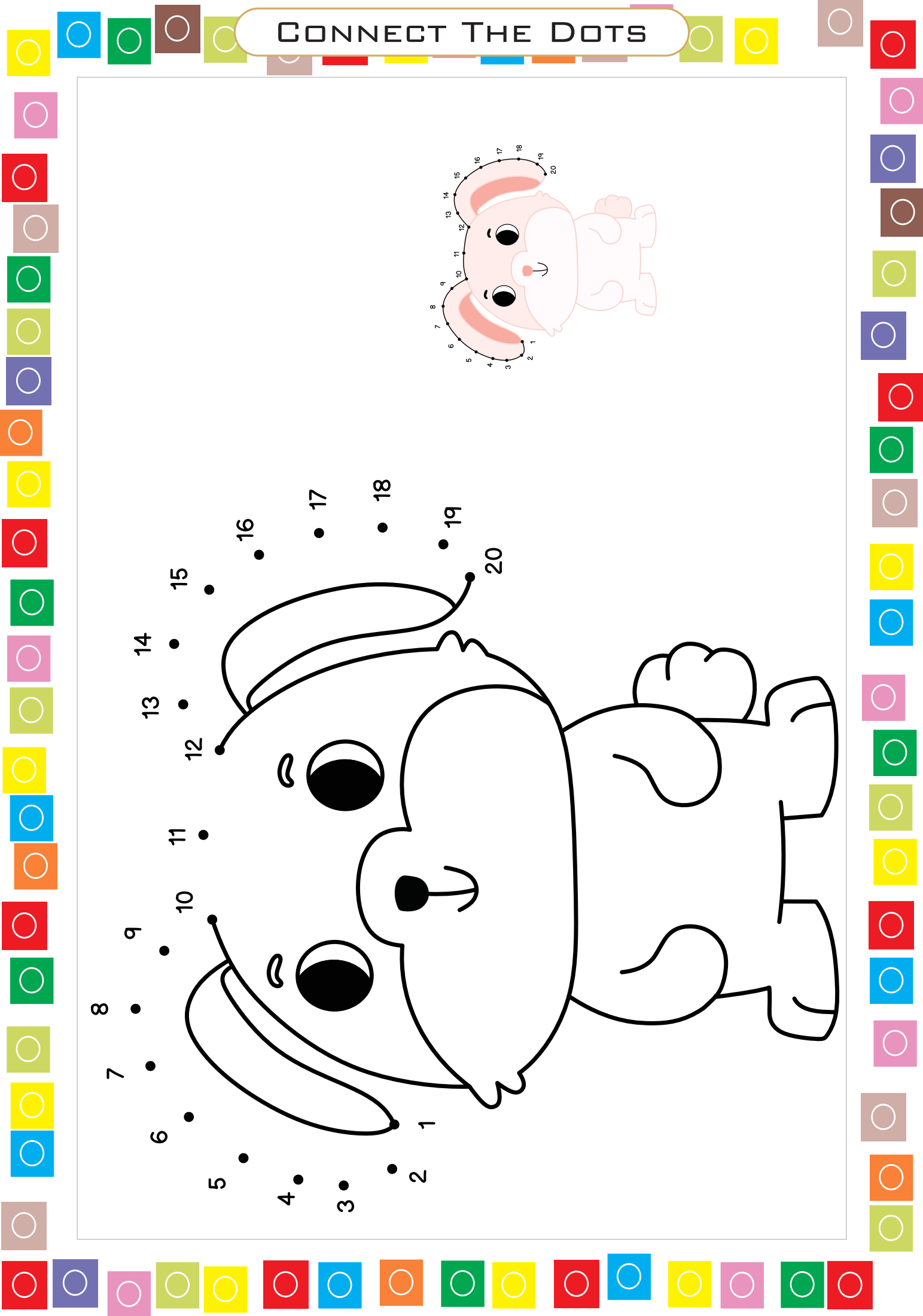
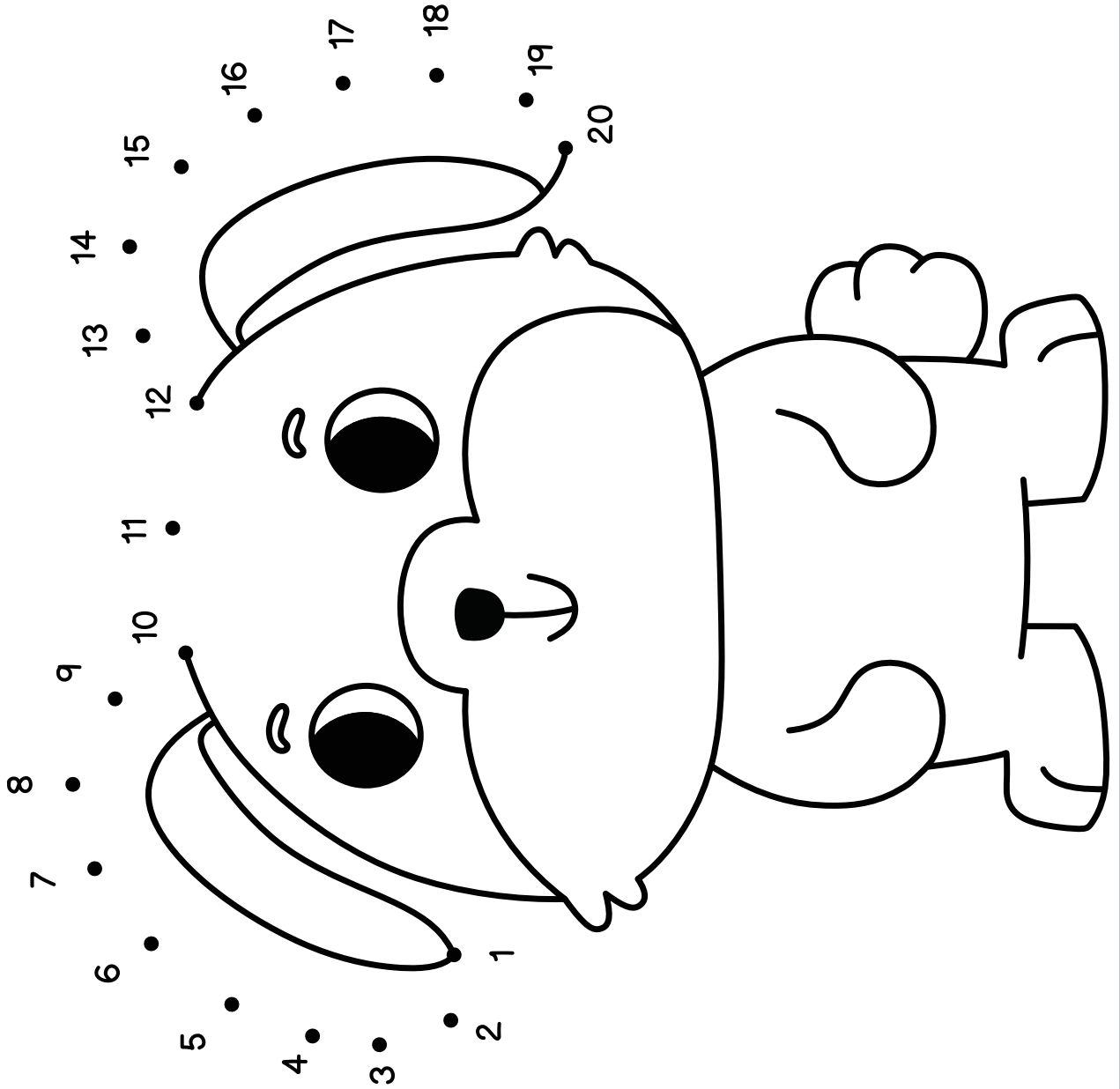
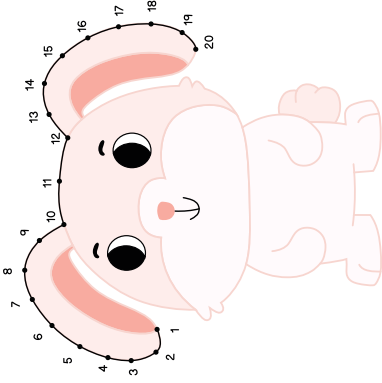

CONNECT THE DOTS

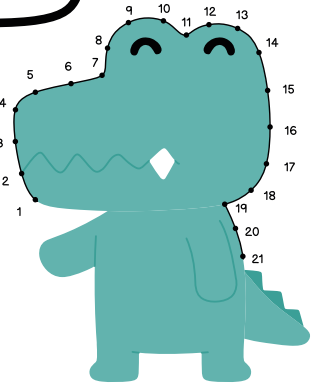
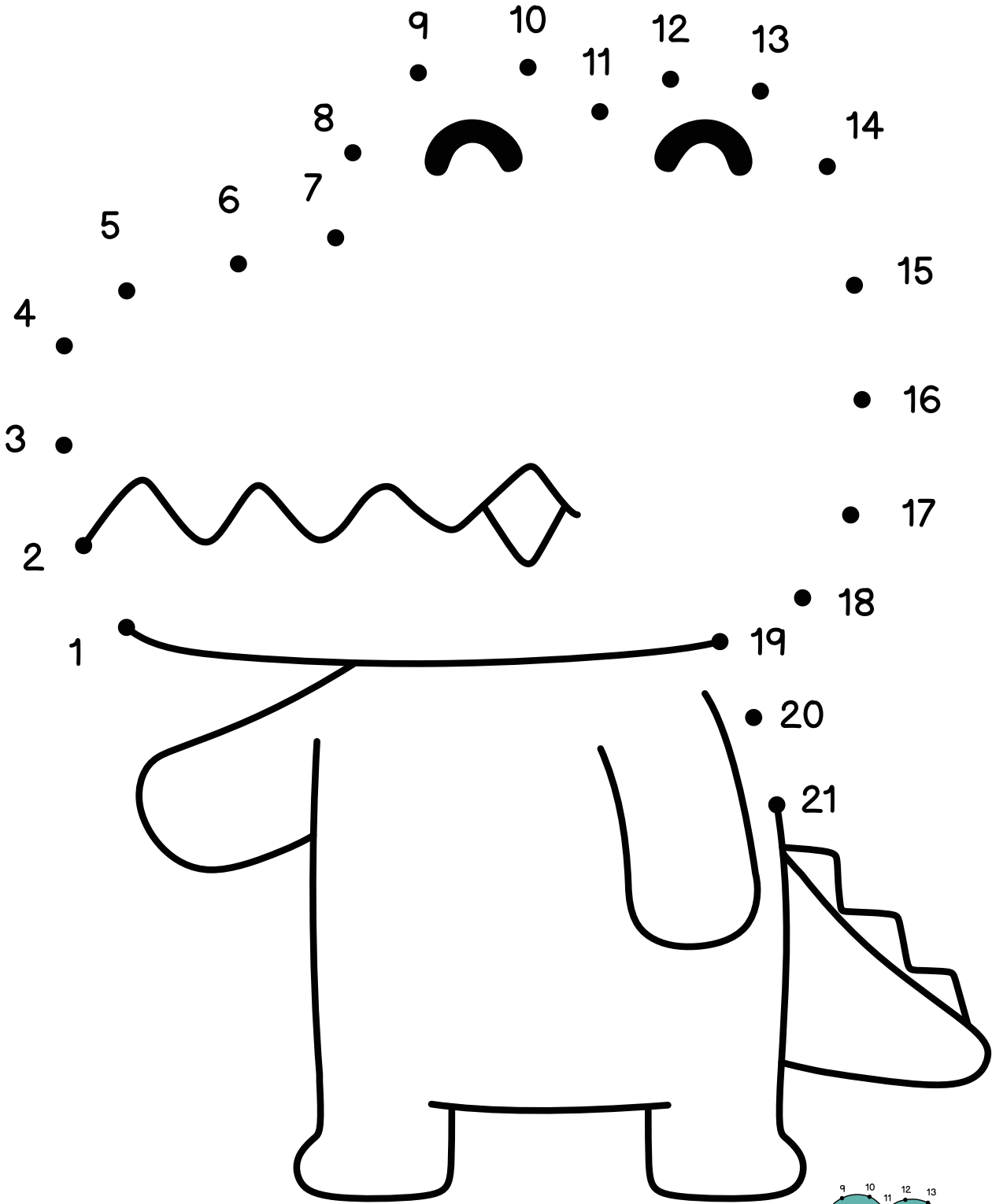

CONNECT THE DOTS

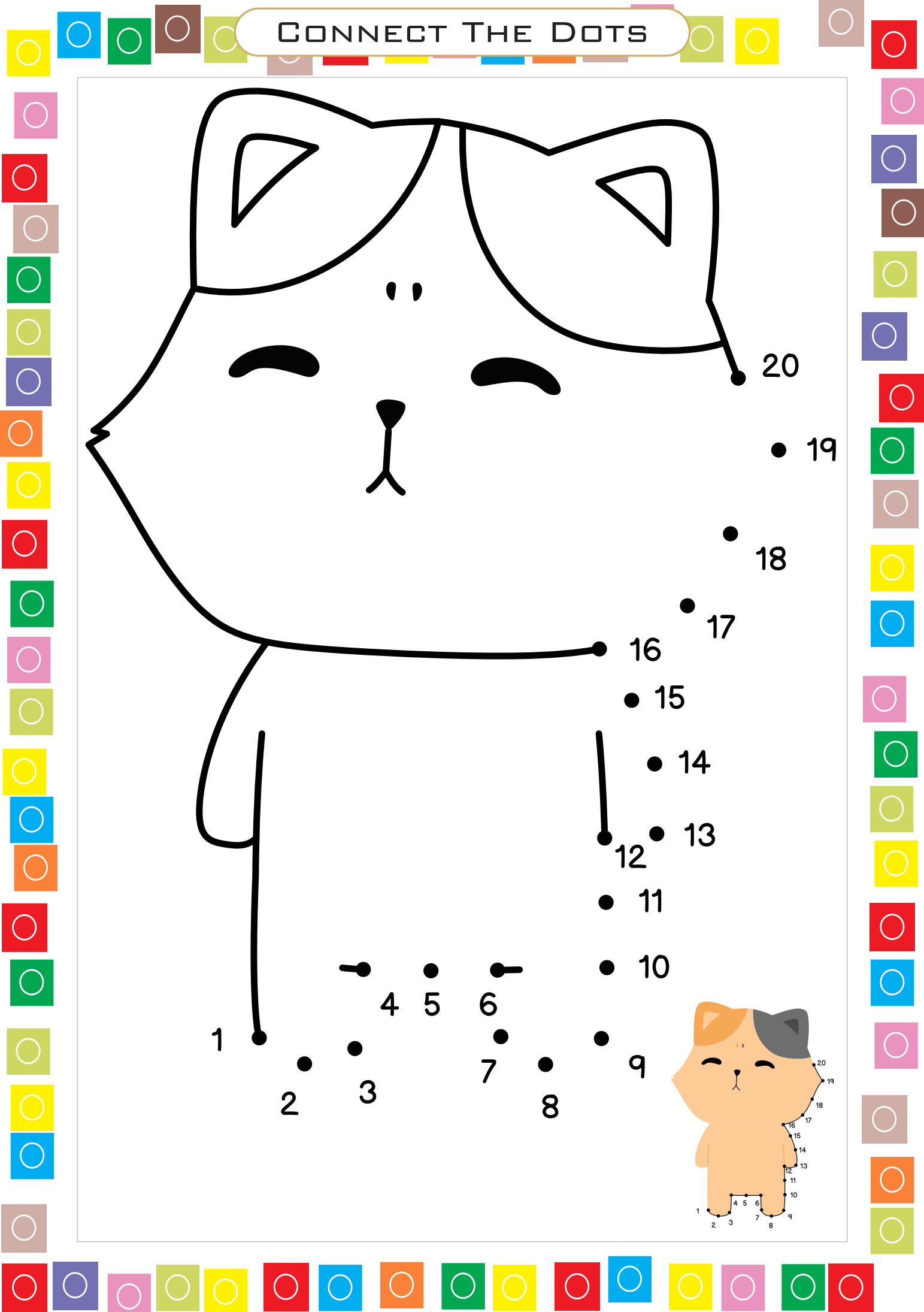
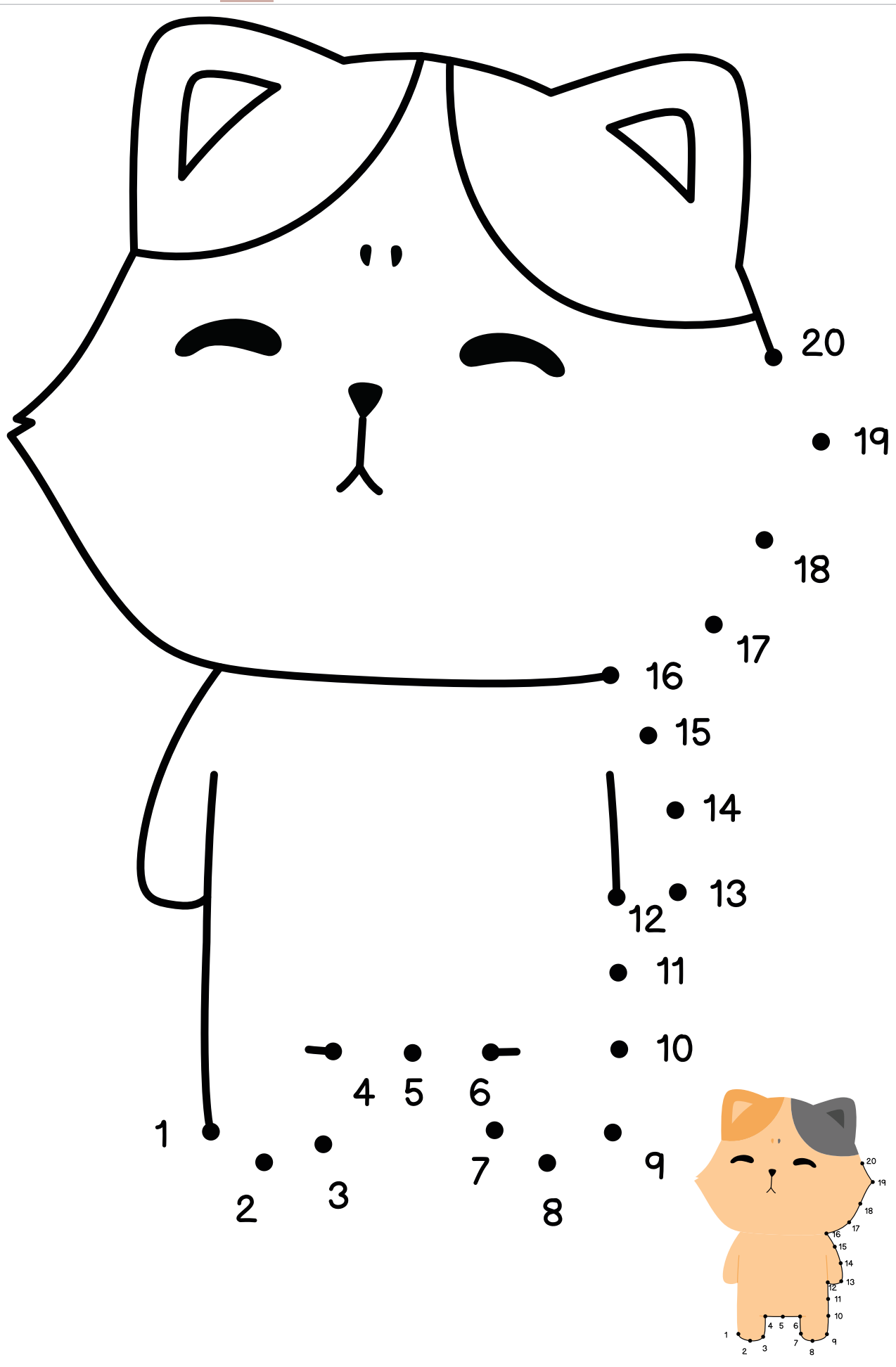

CONNECT THE DOTS

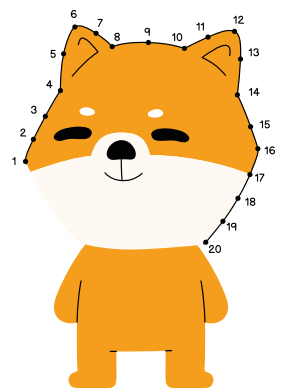
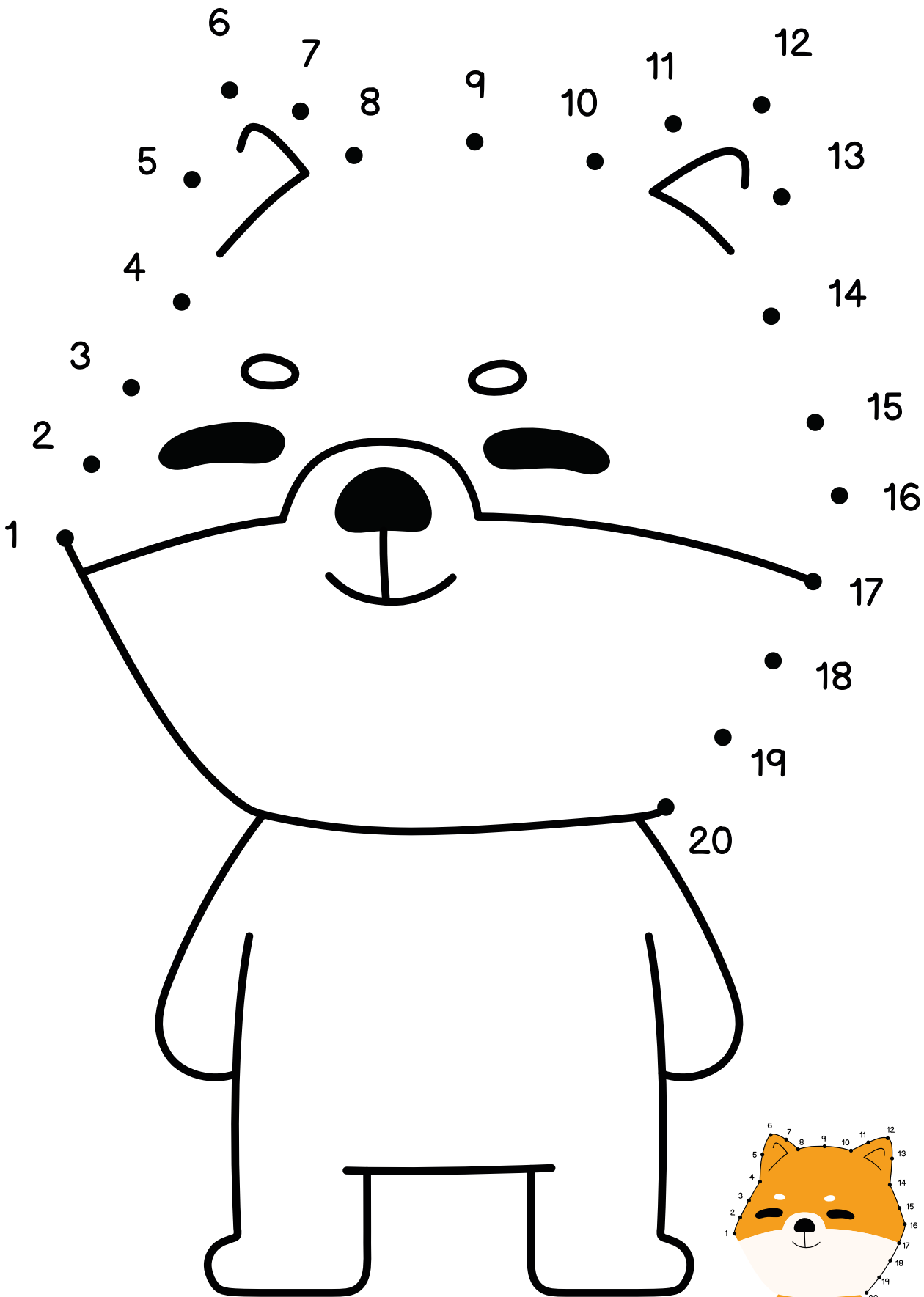

CONNECT THE DOTS

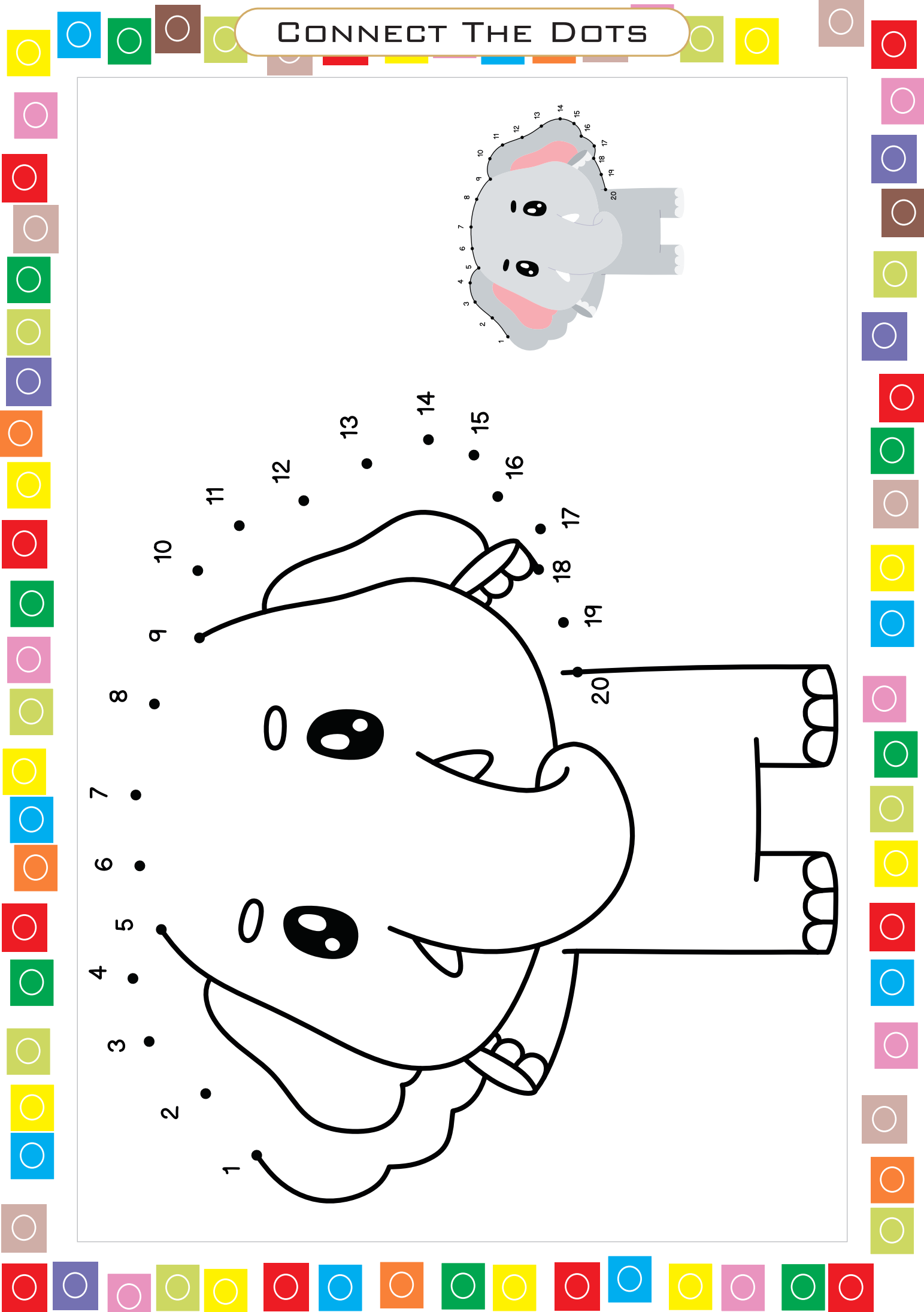
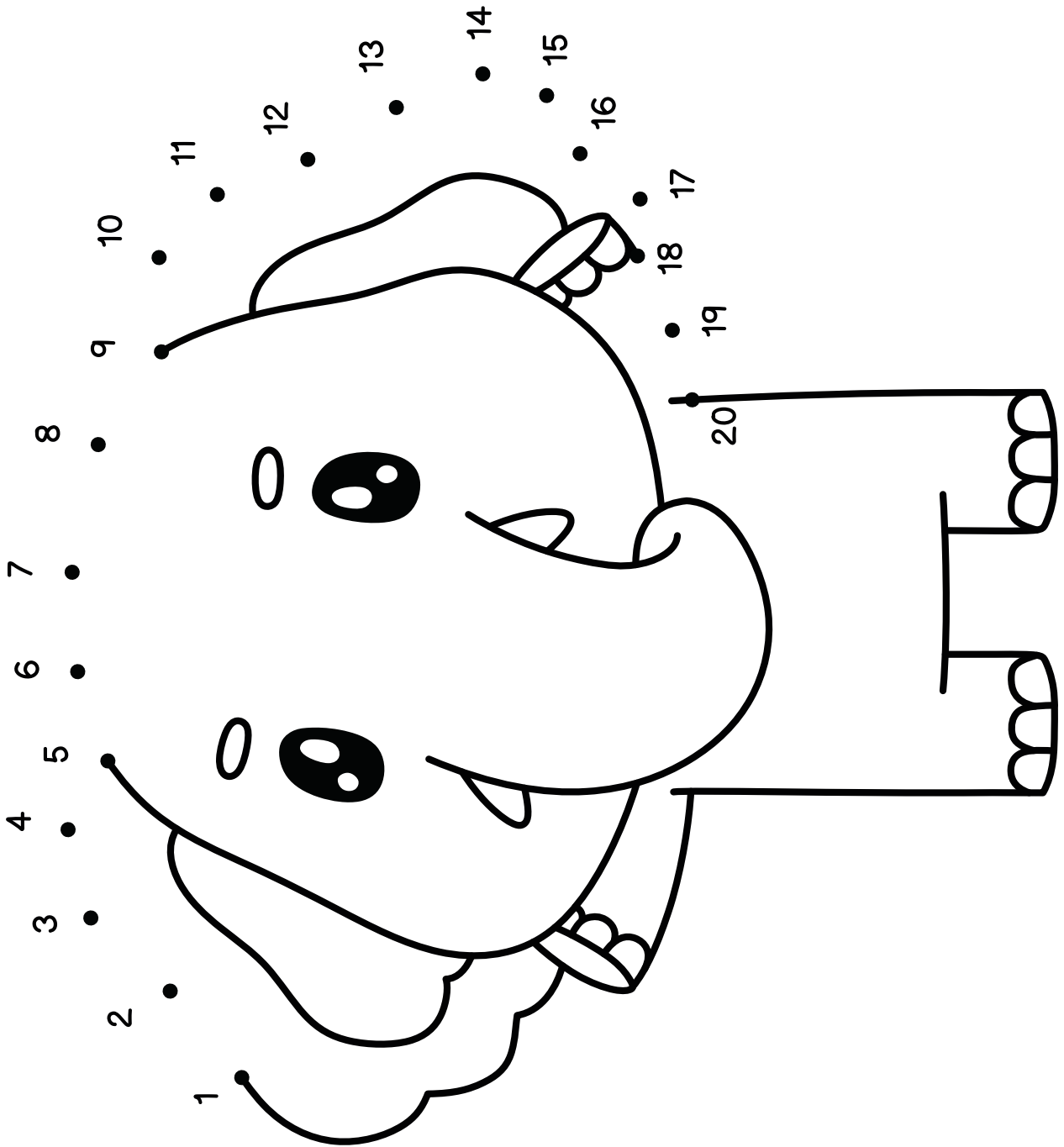
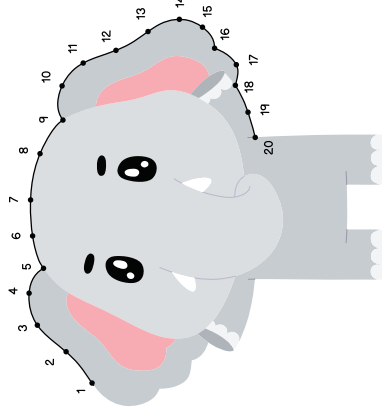

CONNECT THE DOTS

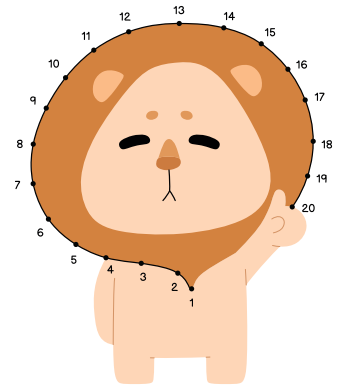

CONNECT THE DOTS

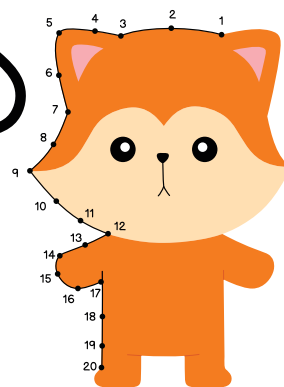
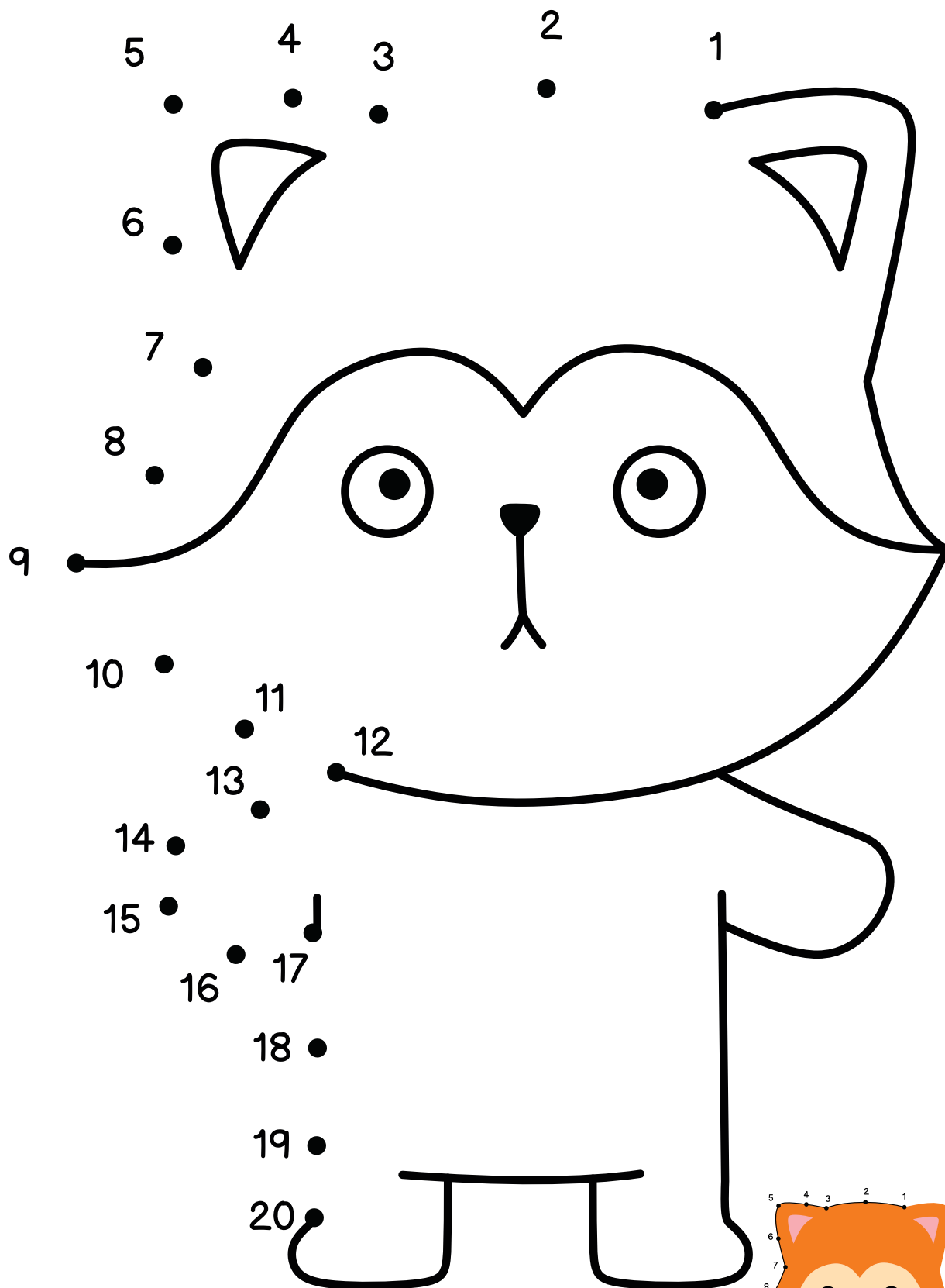

CONNECT THE DOTS

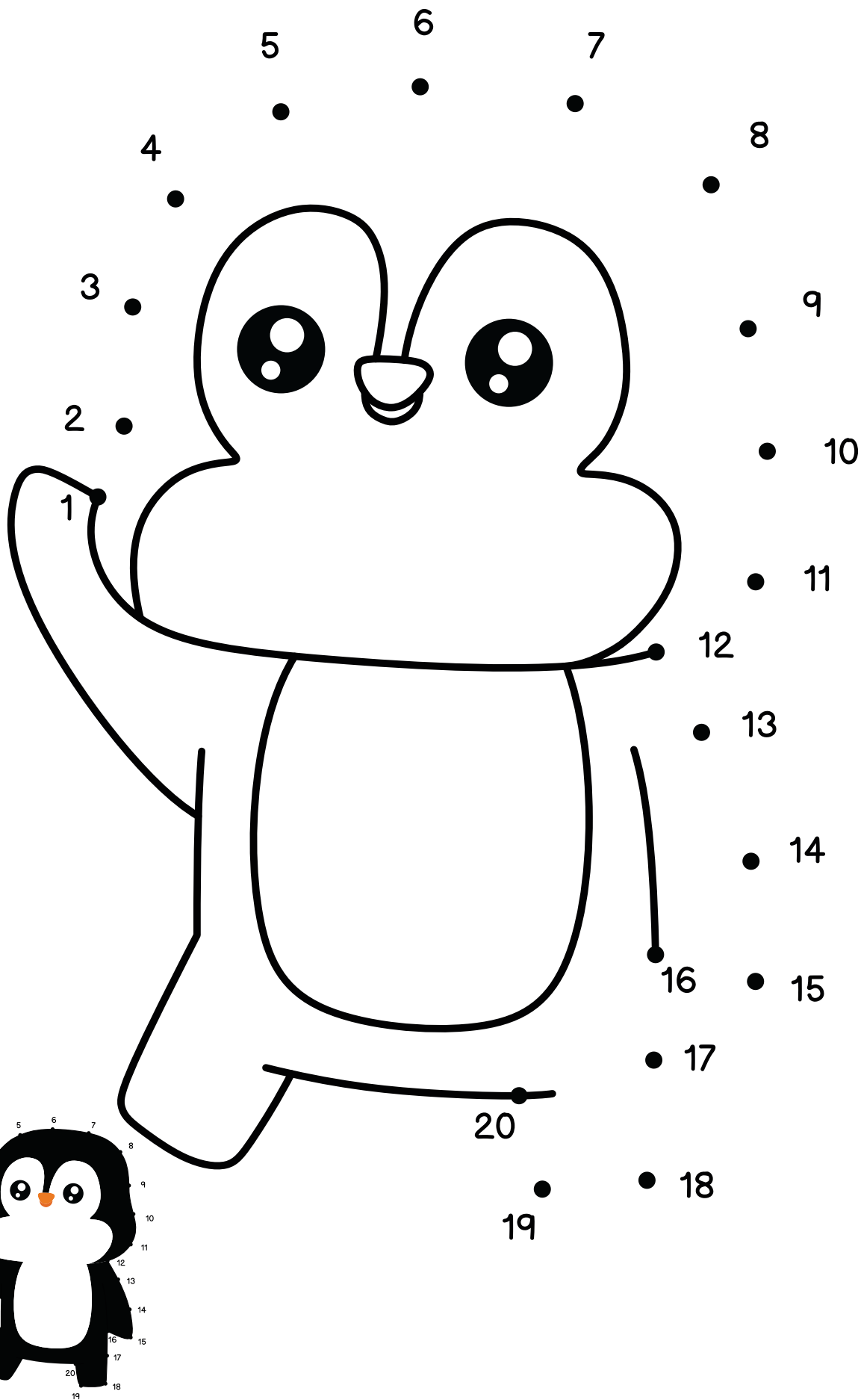

CONNECT THE DOTS

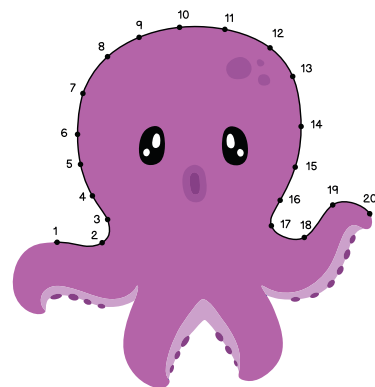
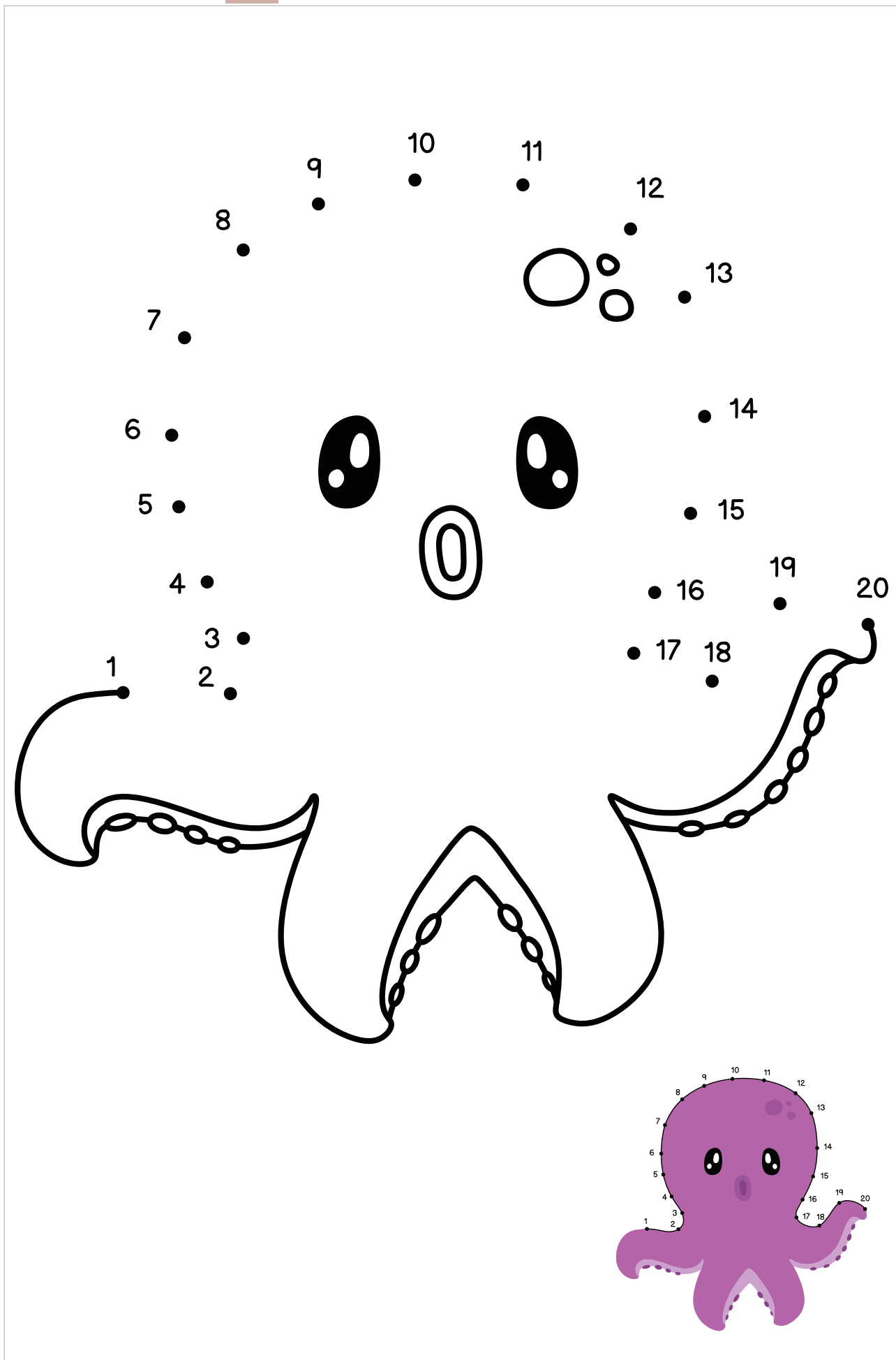

CONNECT THE DOTS

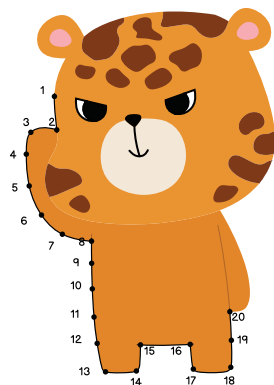
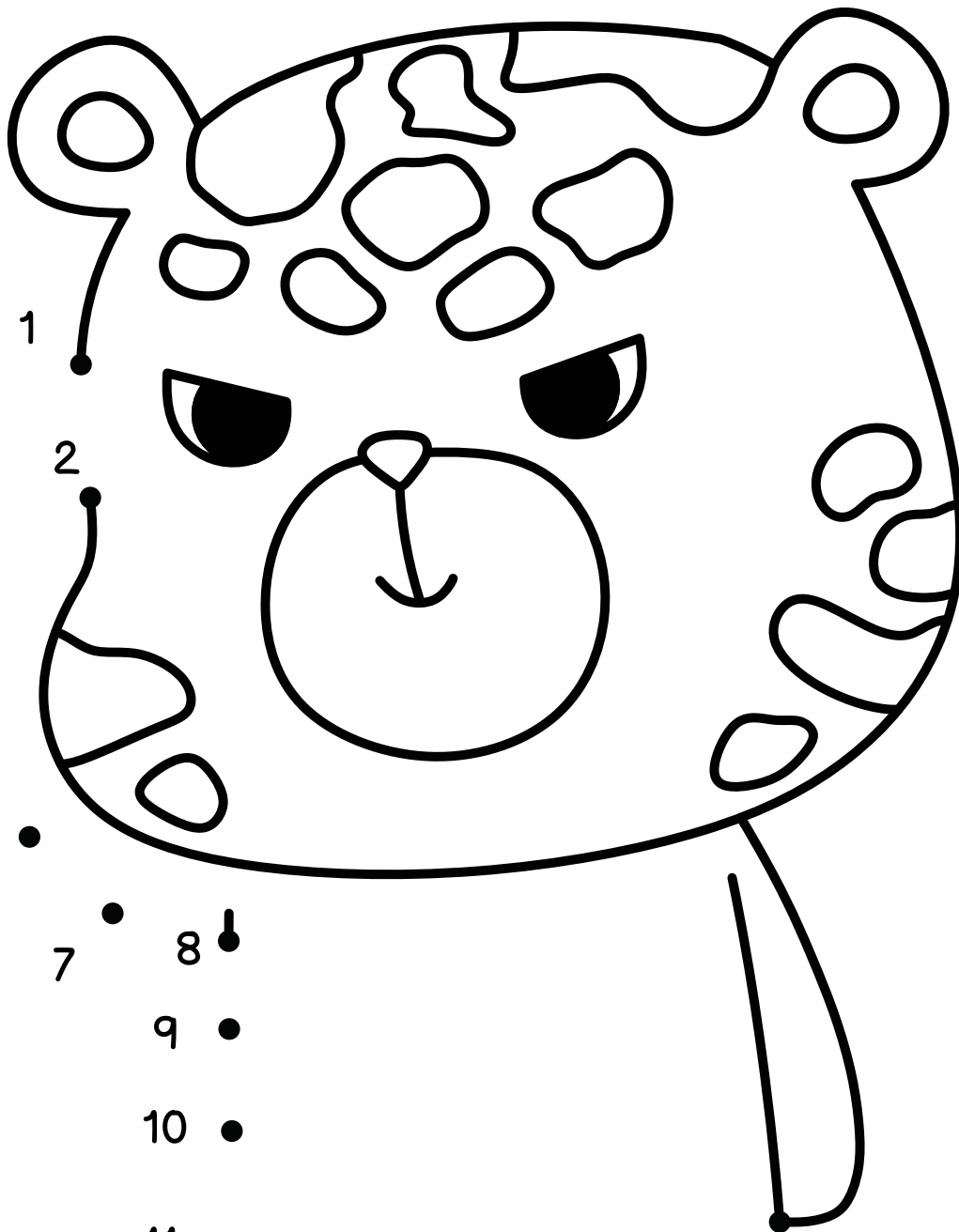

CONNECT THE DOTS

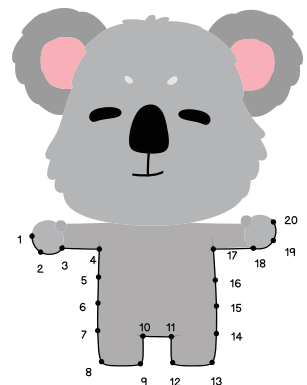
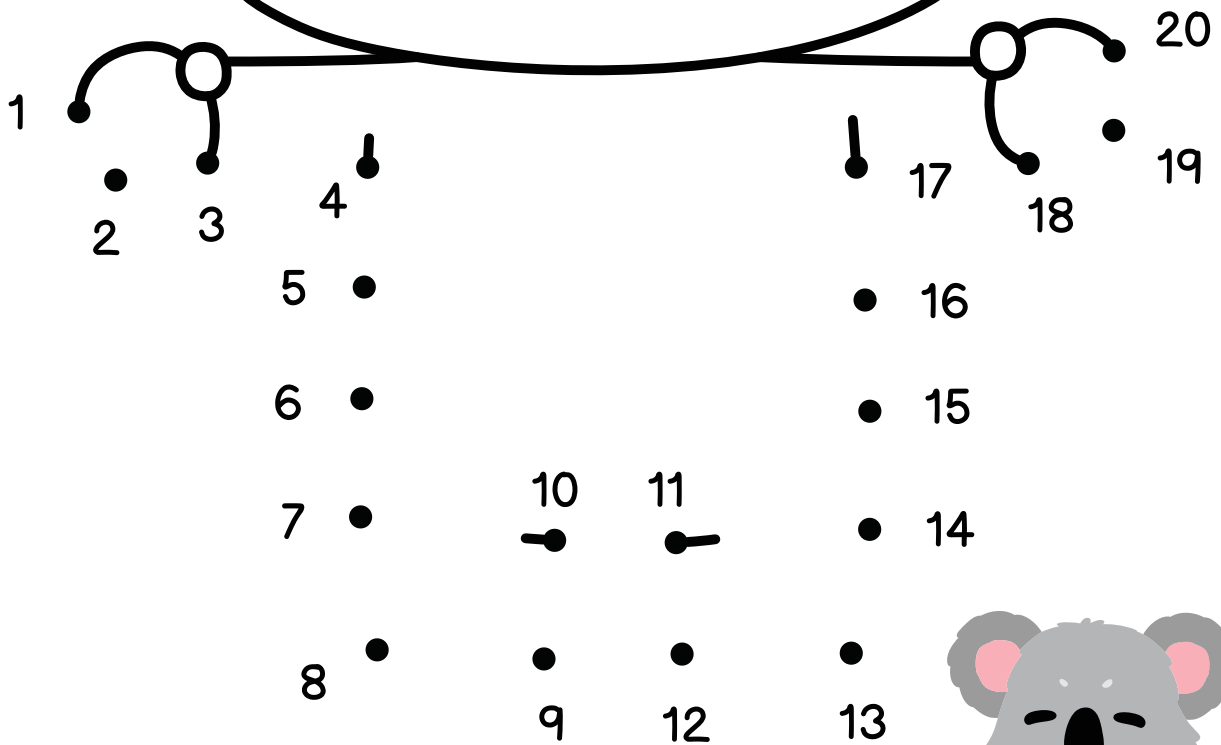
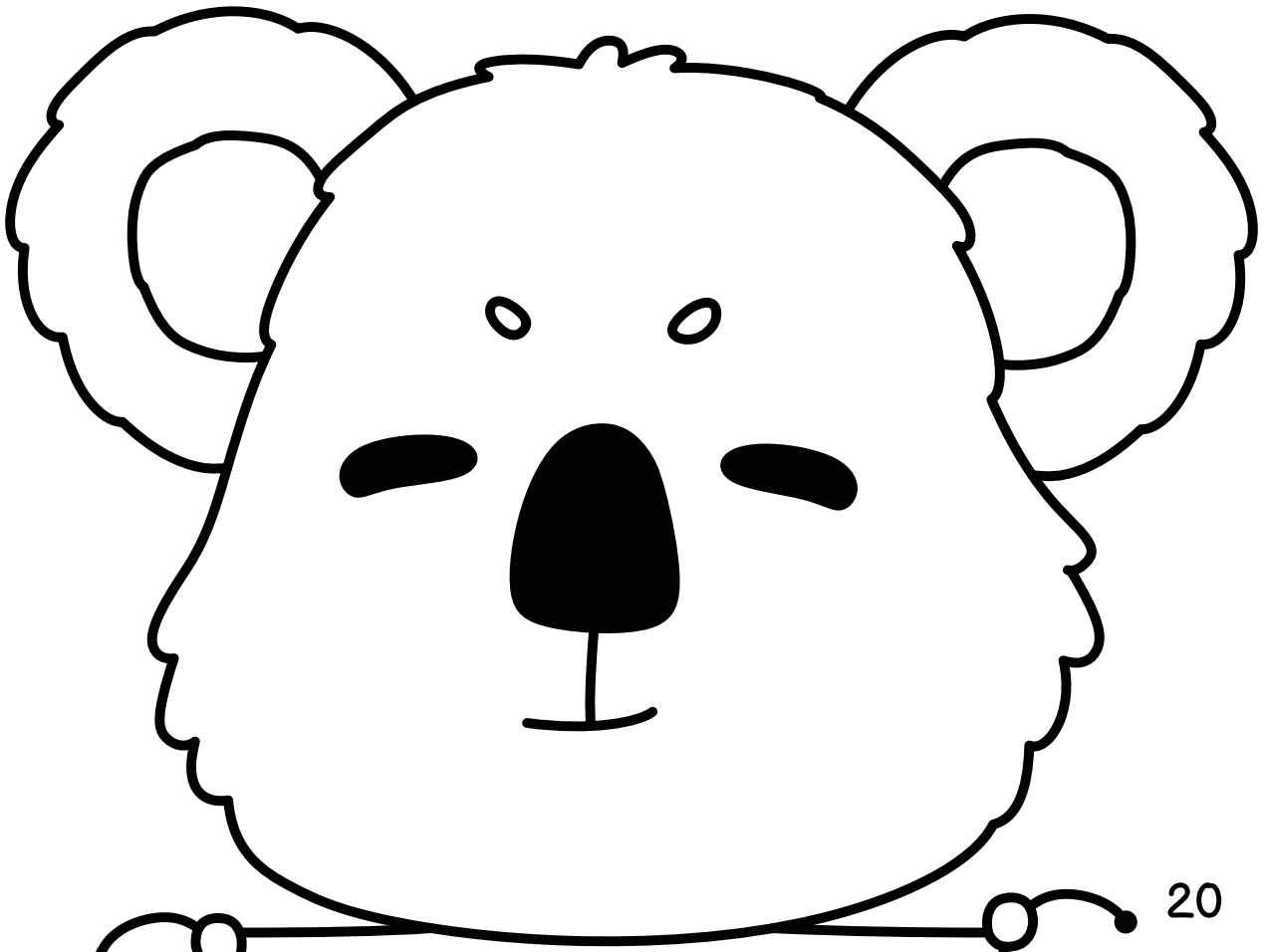

CONNECT THE DOTS

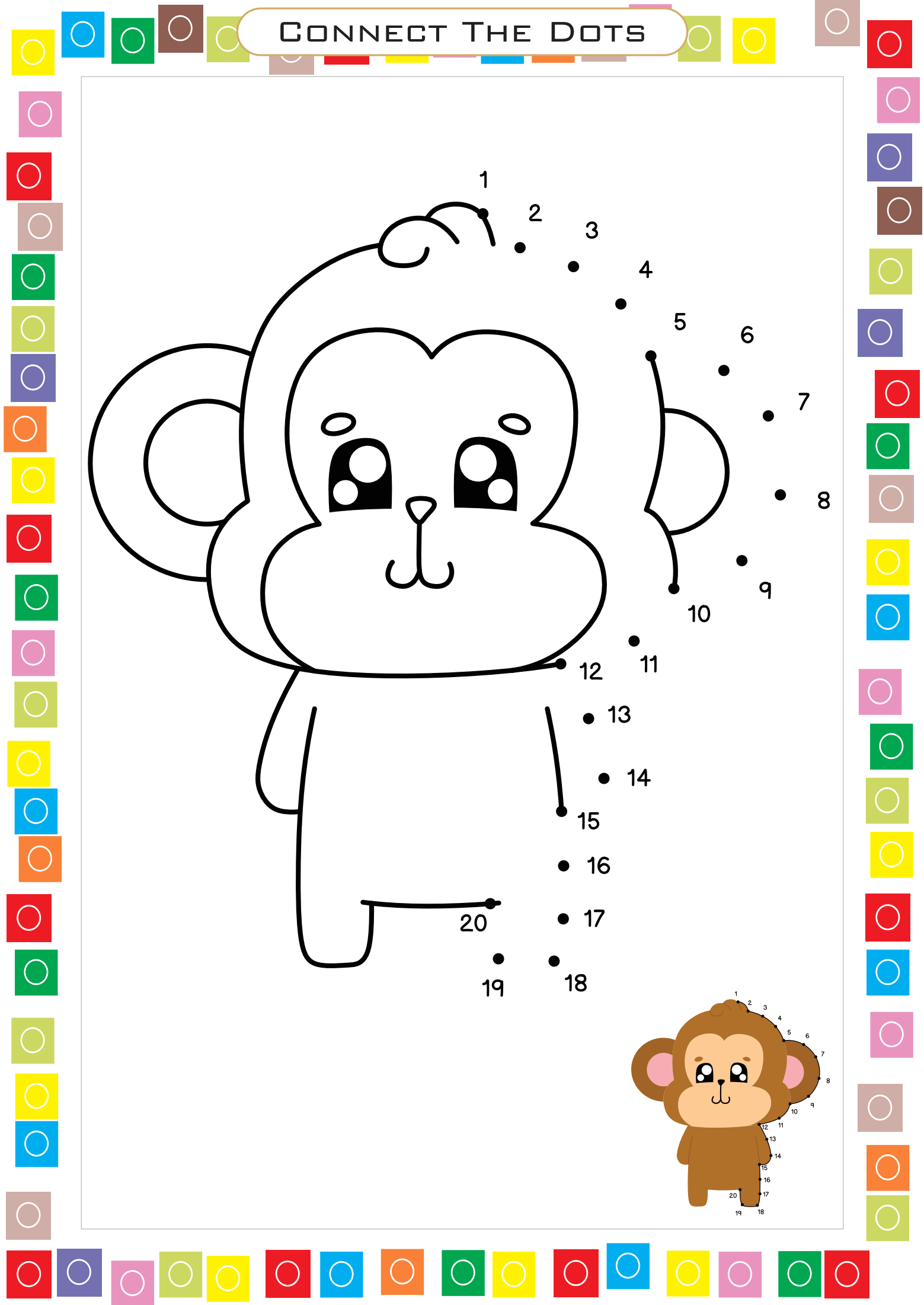
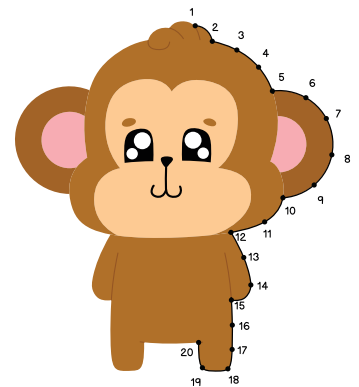
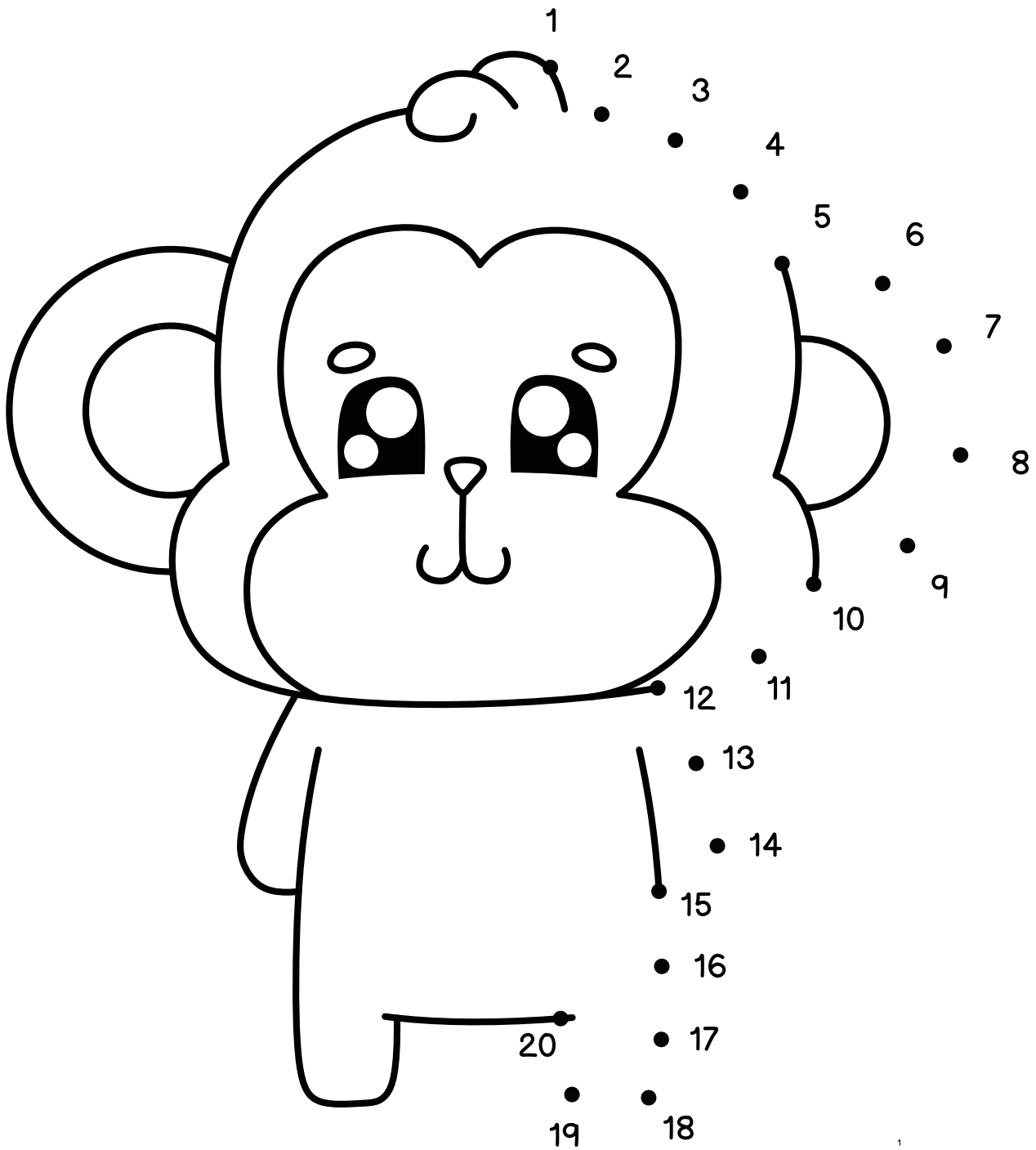

CONNECT THE DOTS

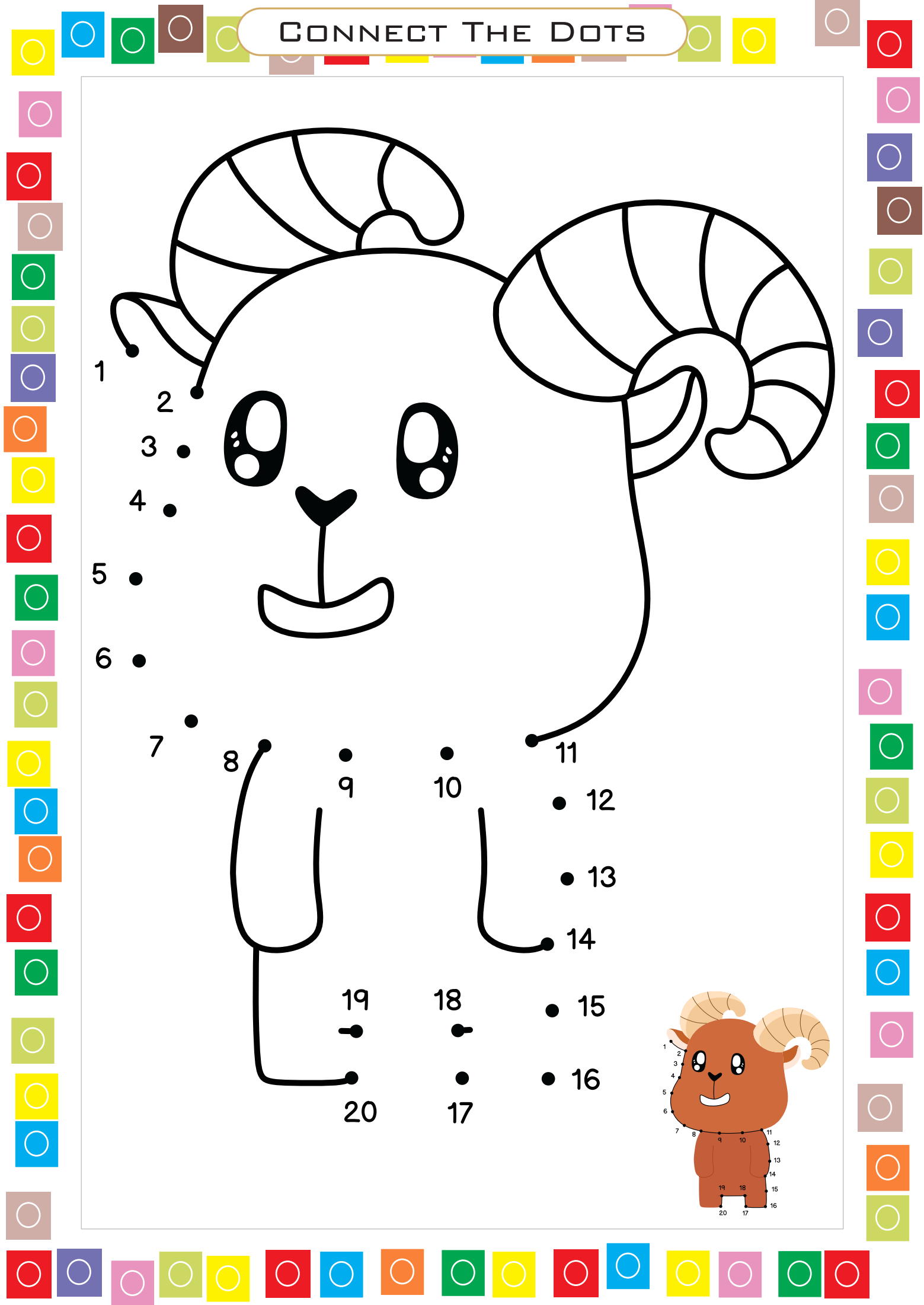
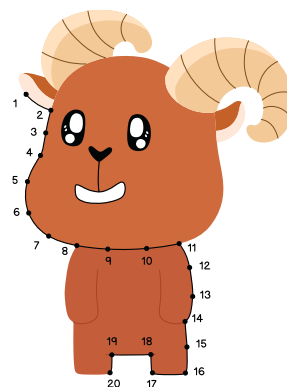
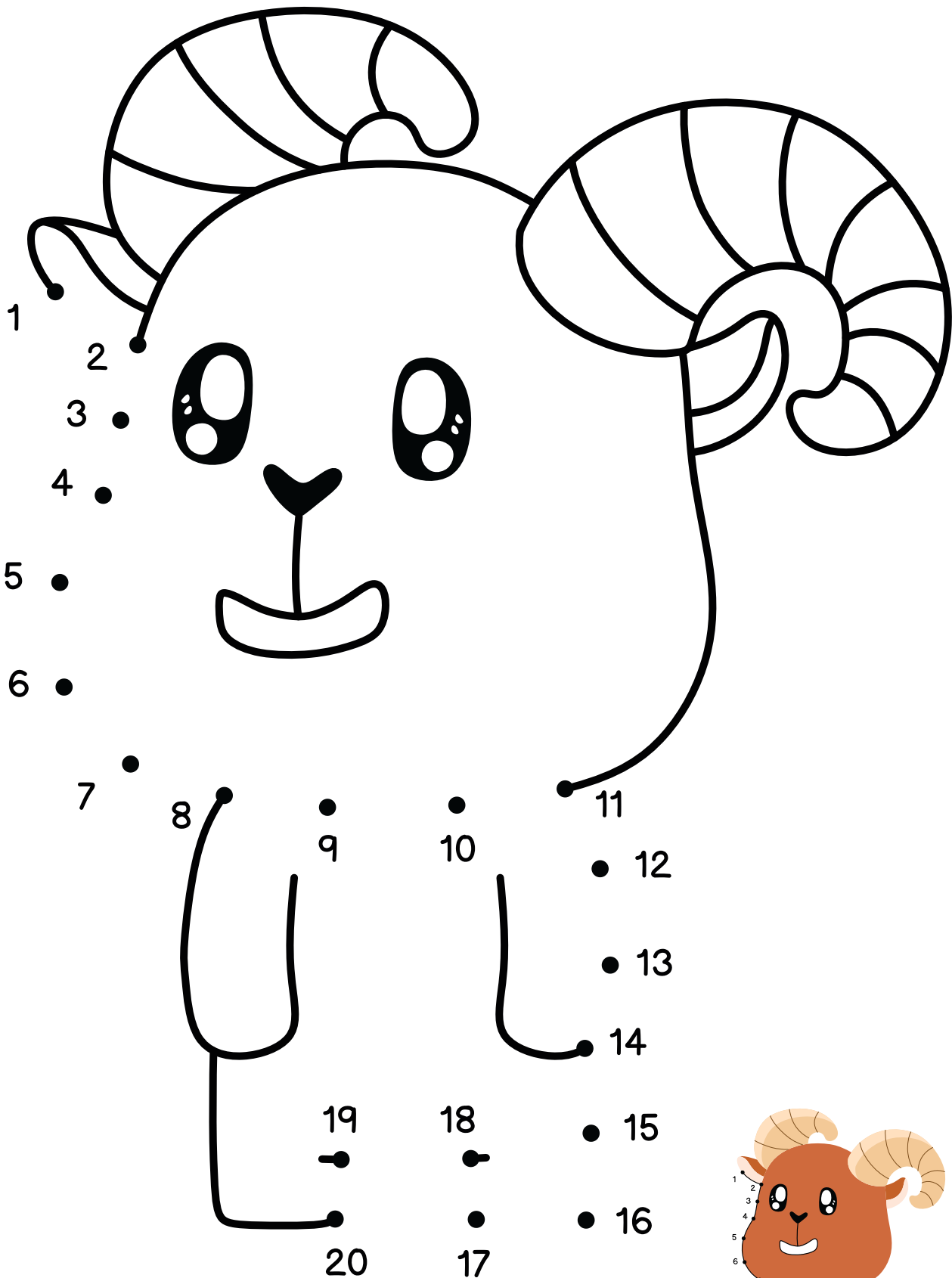

CONNECT THE DOTS

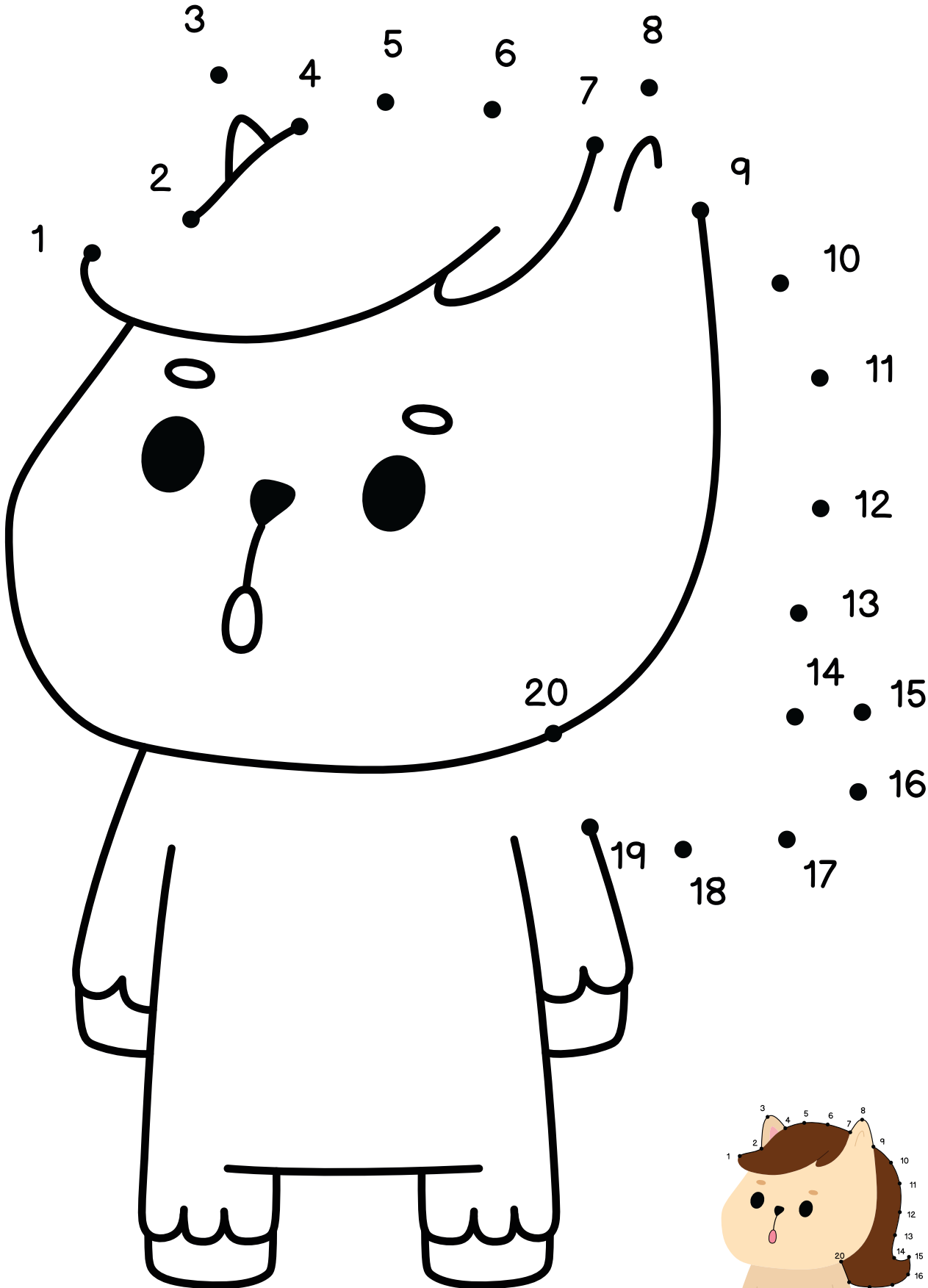

CONNECT THE DOTS

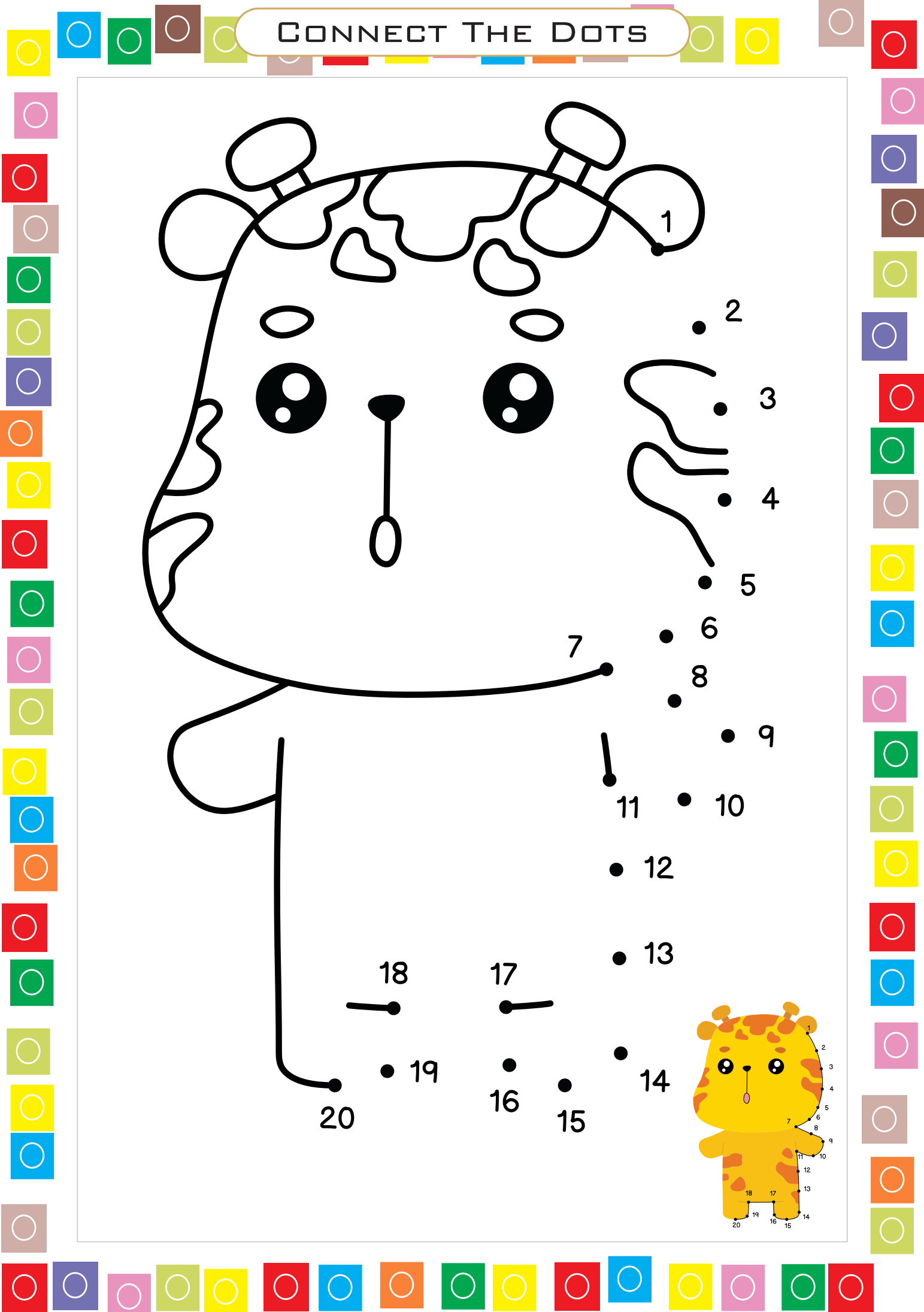
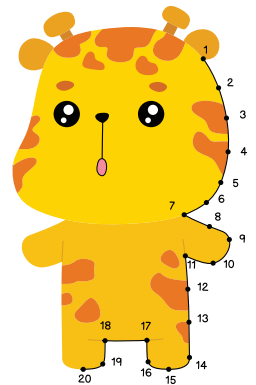
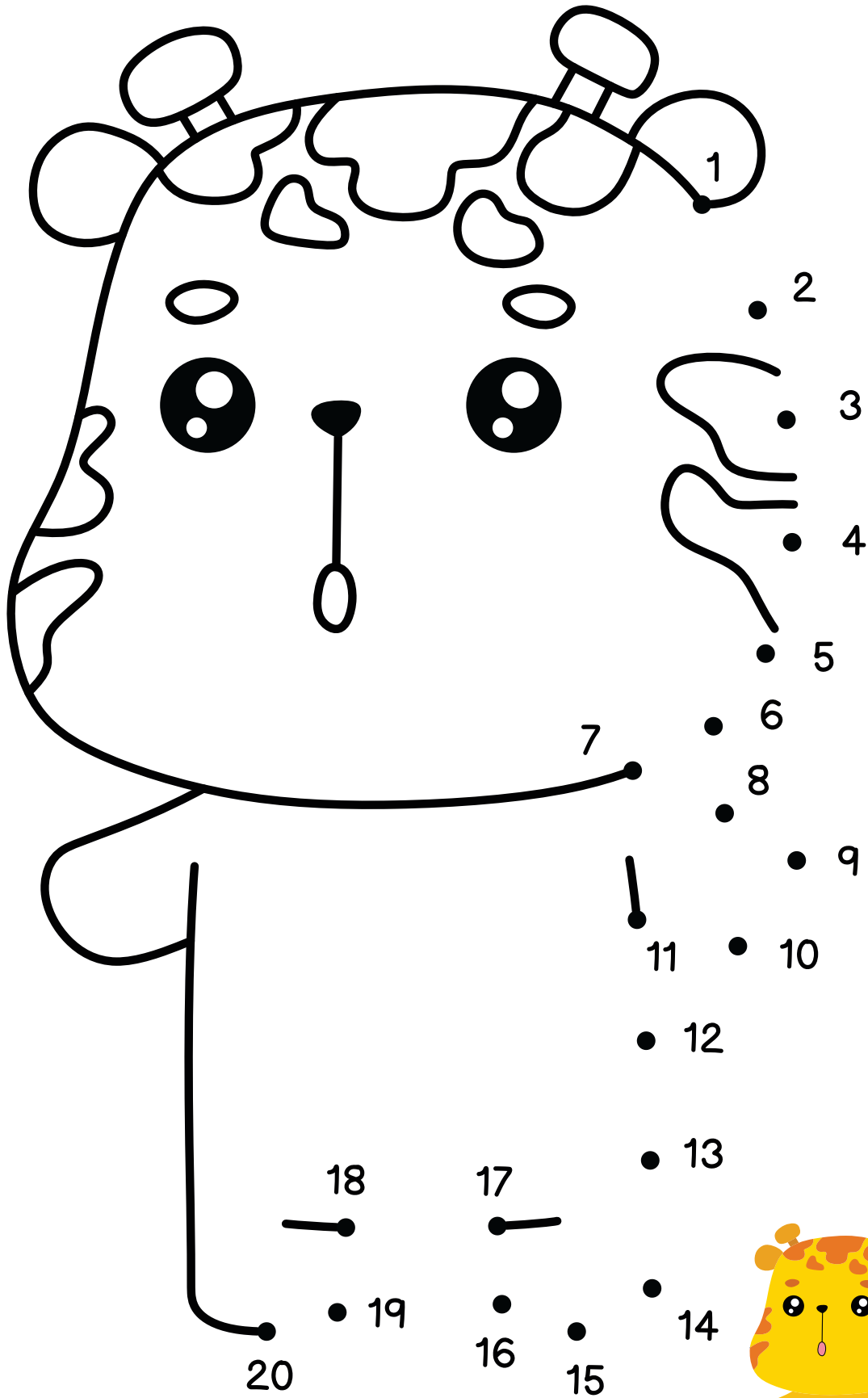

CONNECT THE DOTS

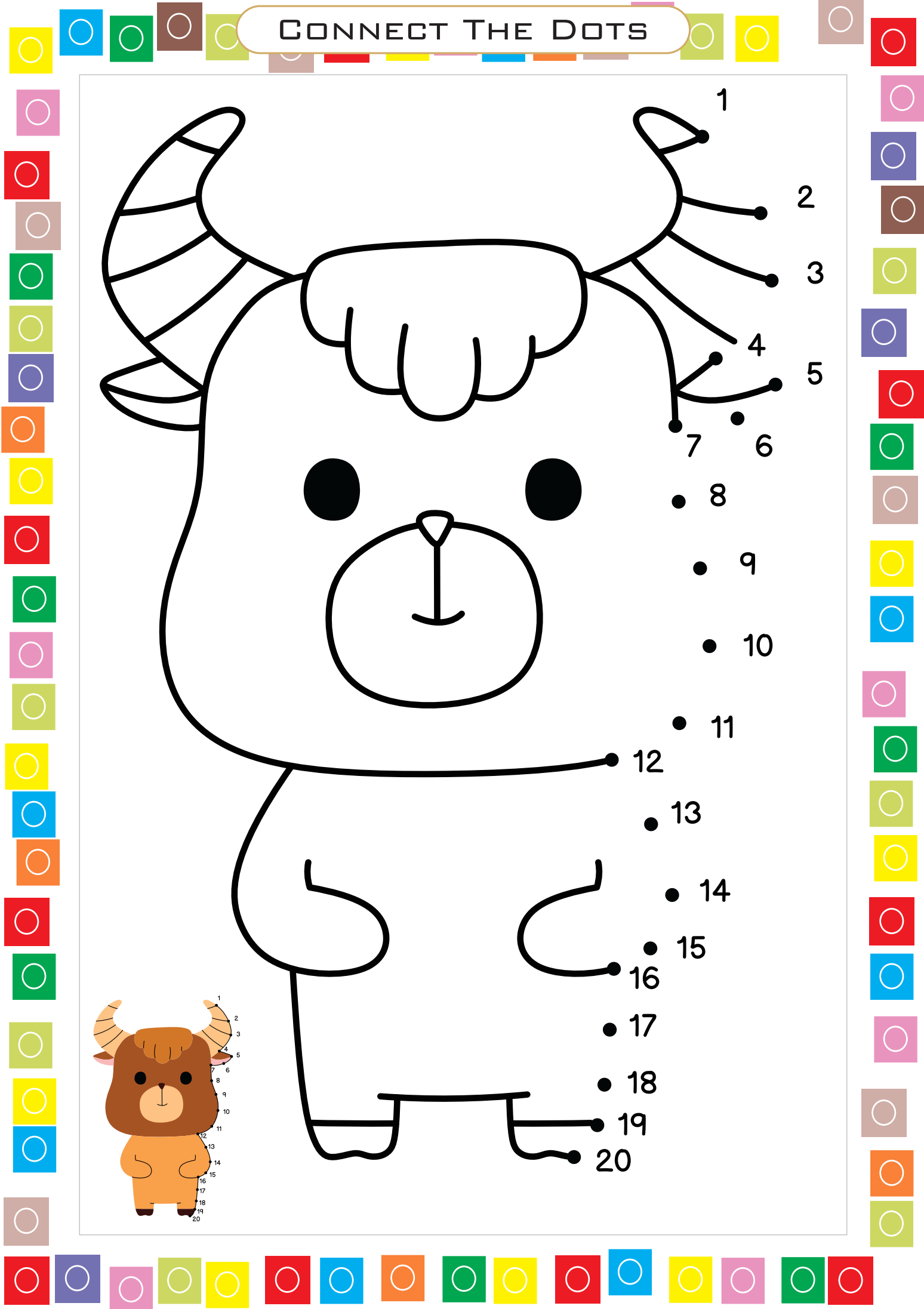
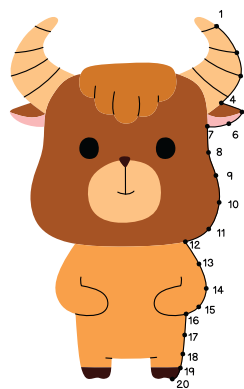
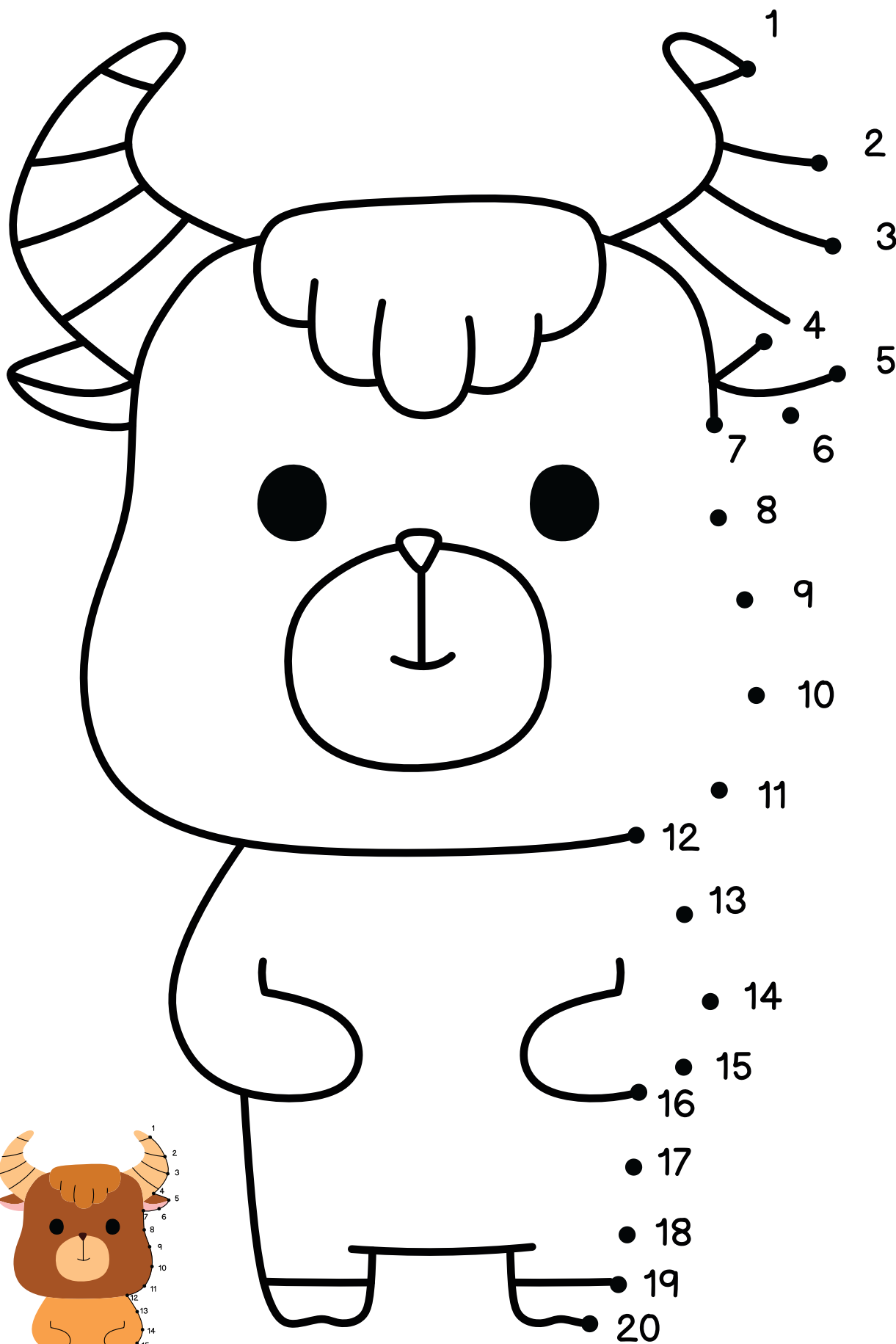

CONNECT THE DOTS

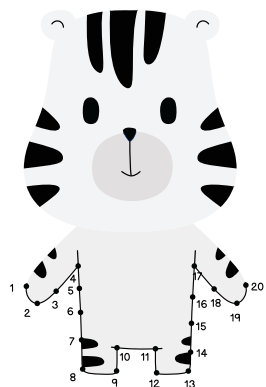
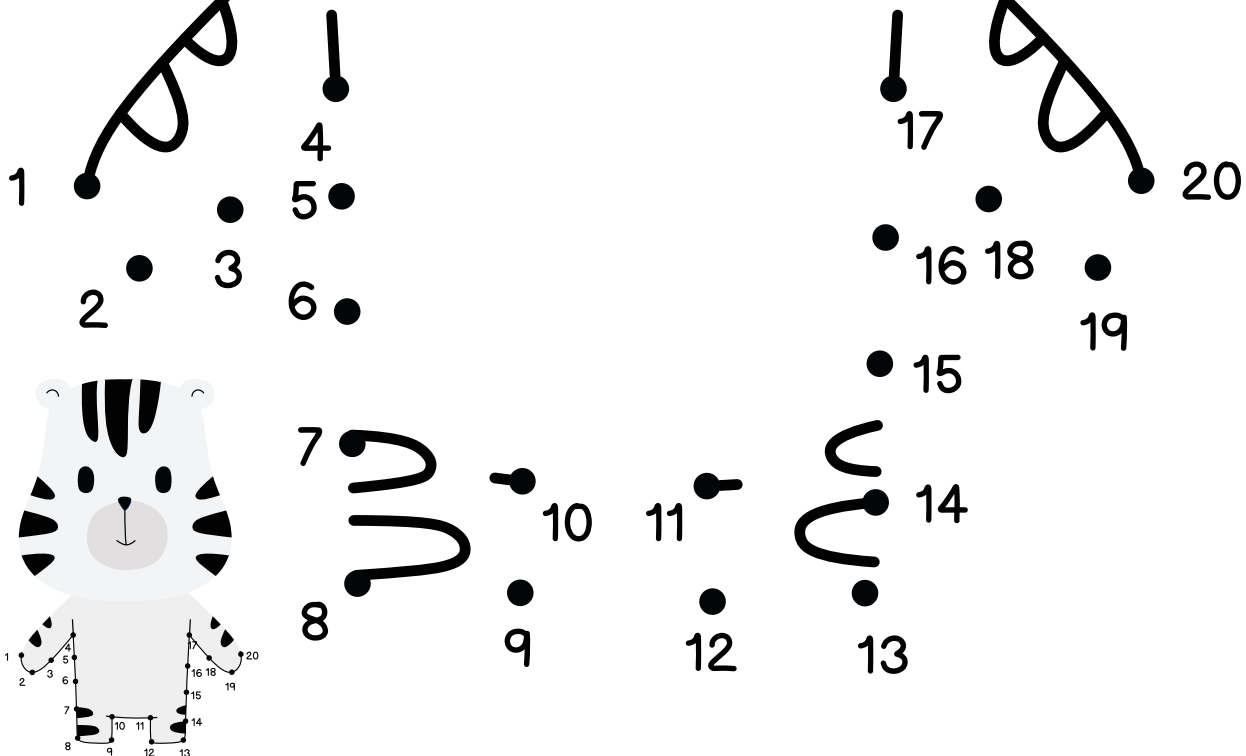
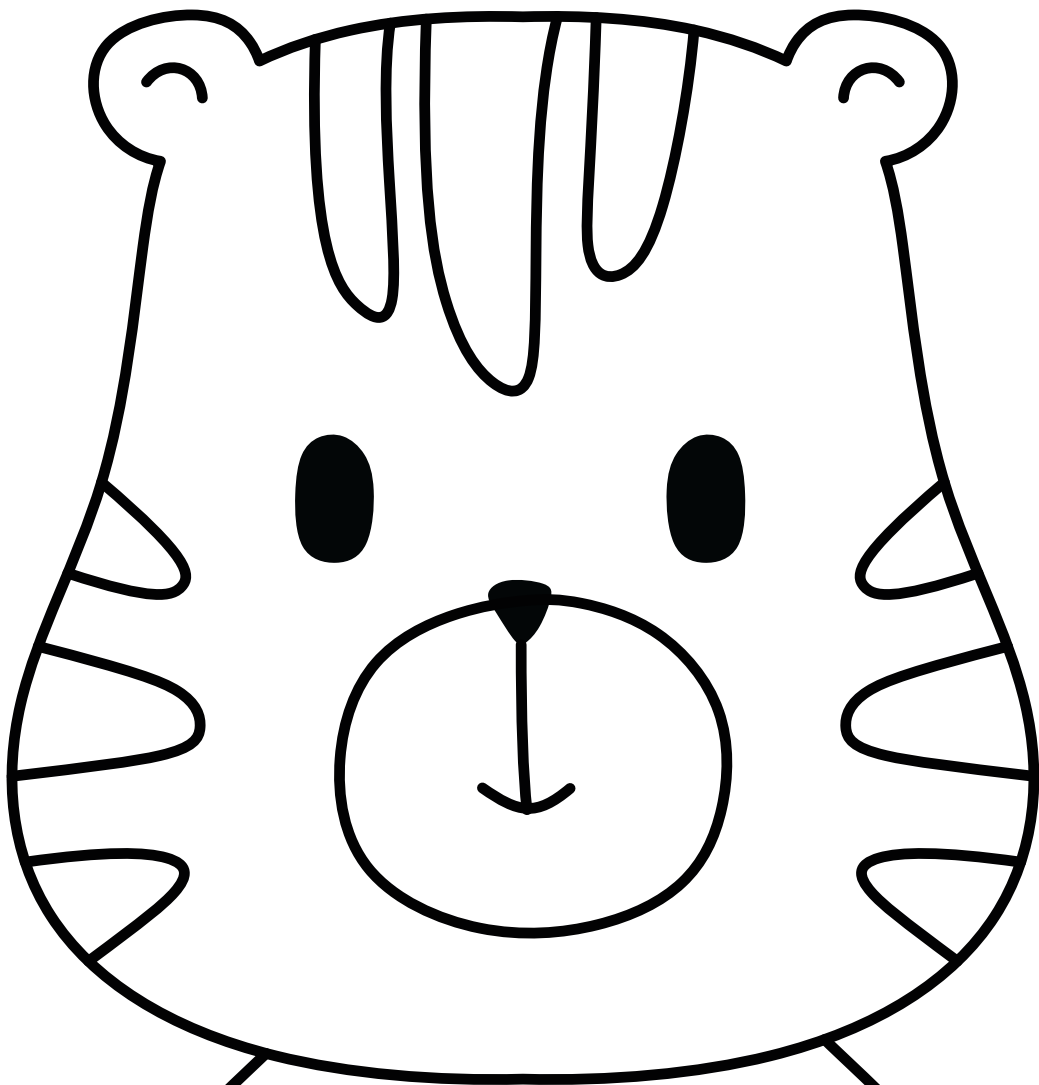

CONNECT THE DOTS

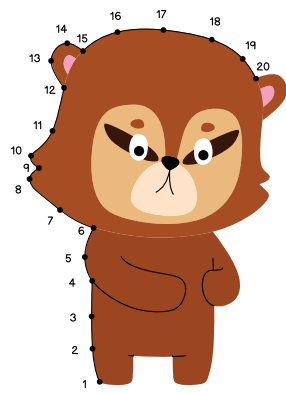
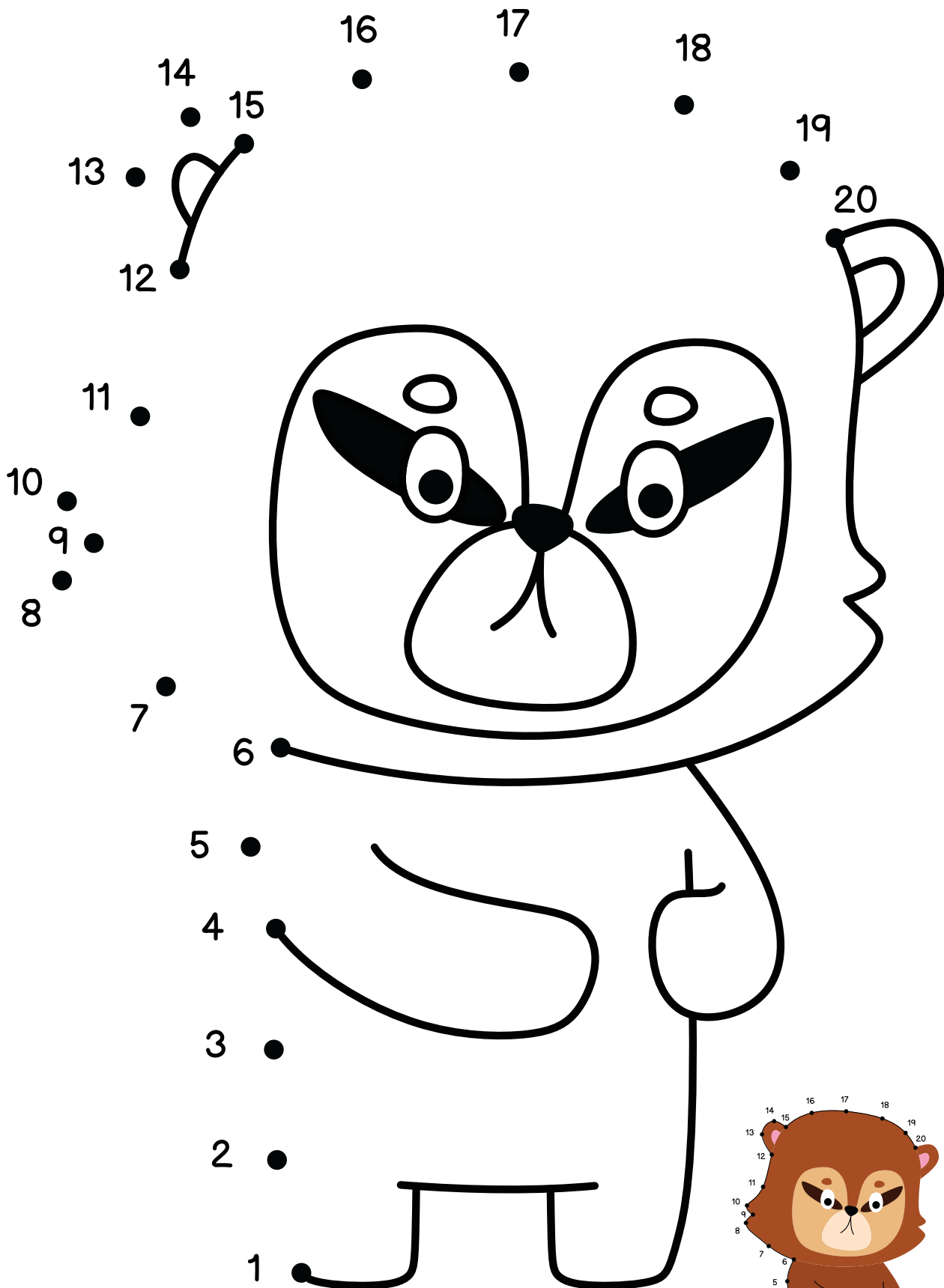

CONNECT THE DOTS

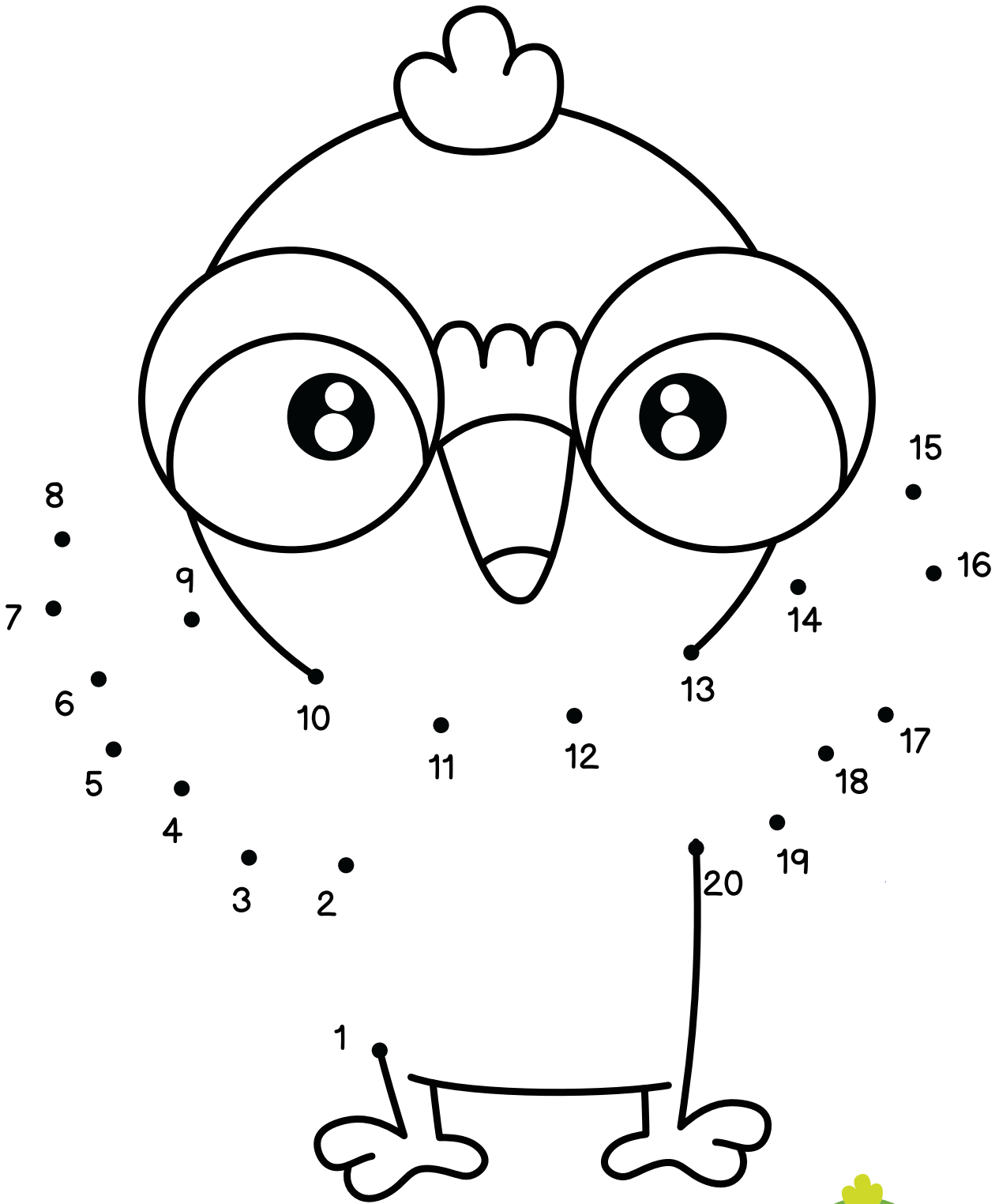

CONNECT THE DOTS

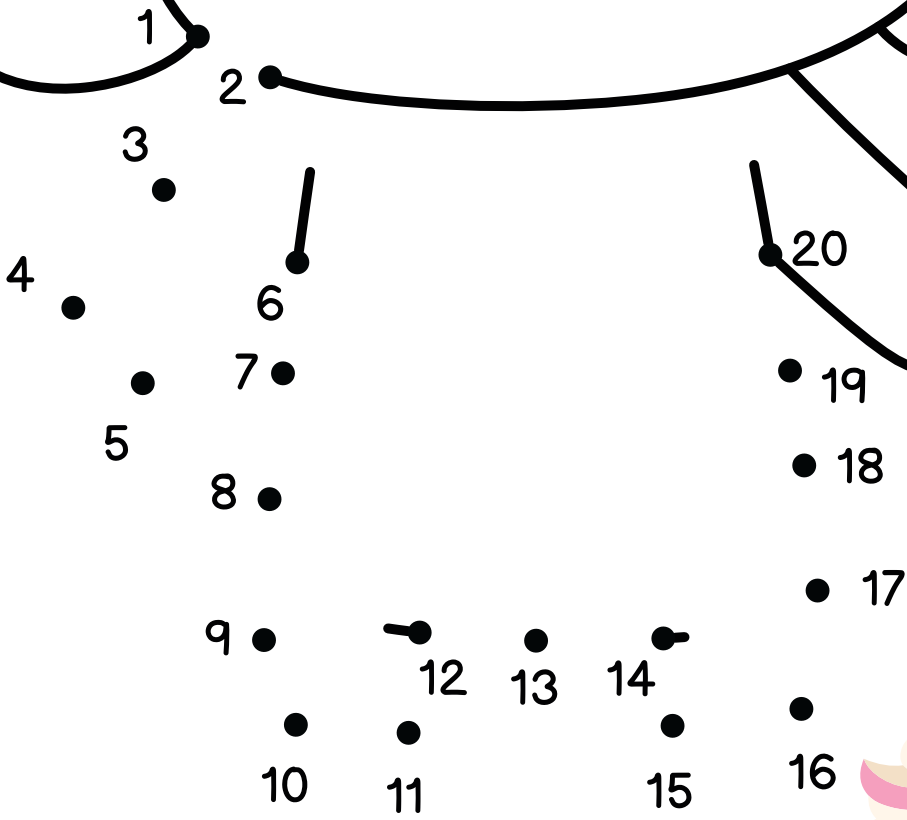

CONNECT THE DOTS

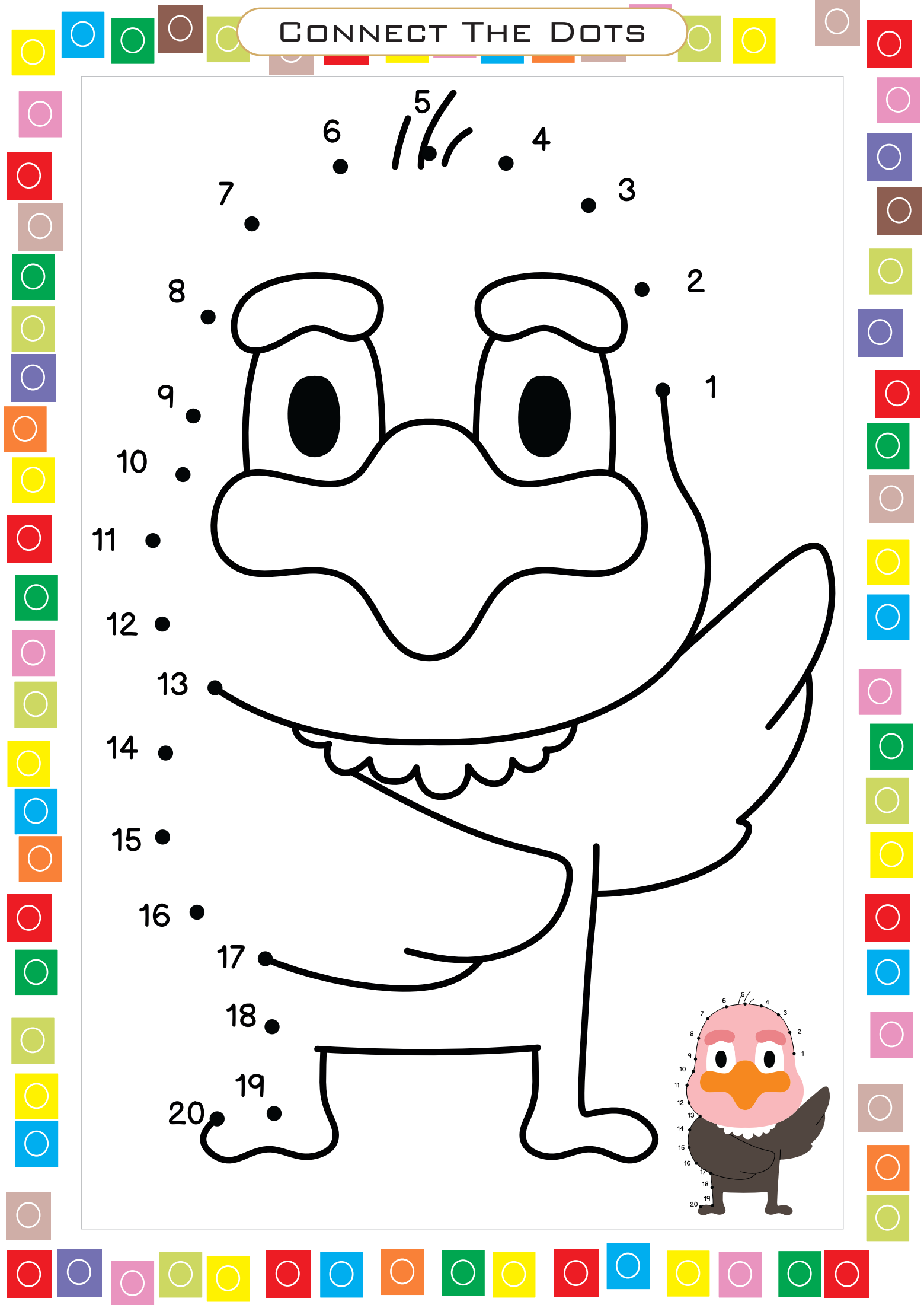
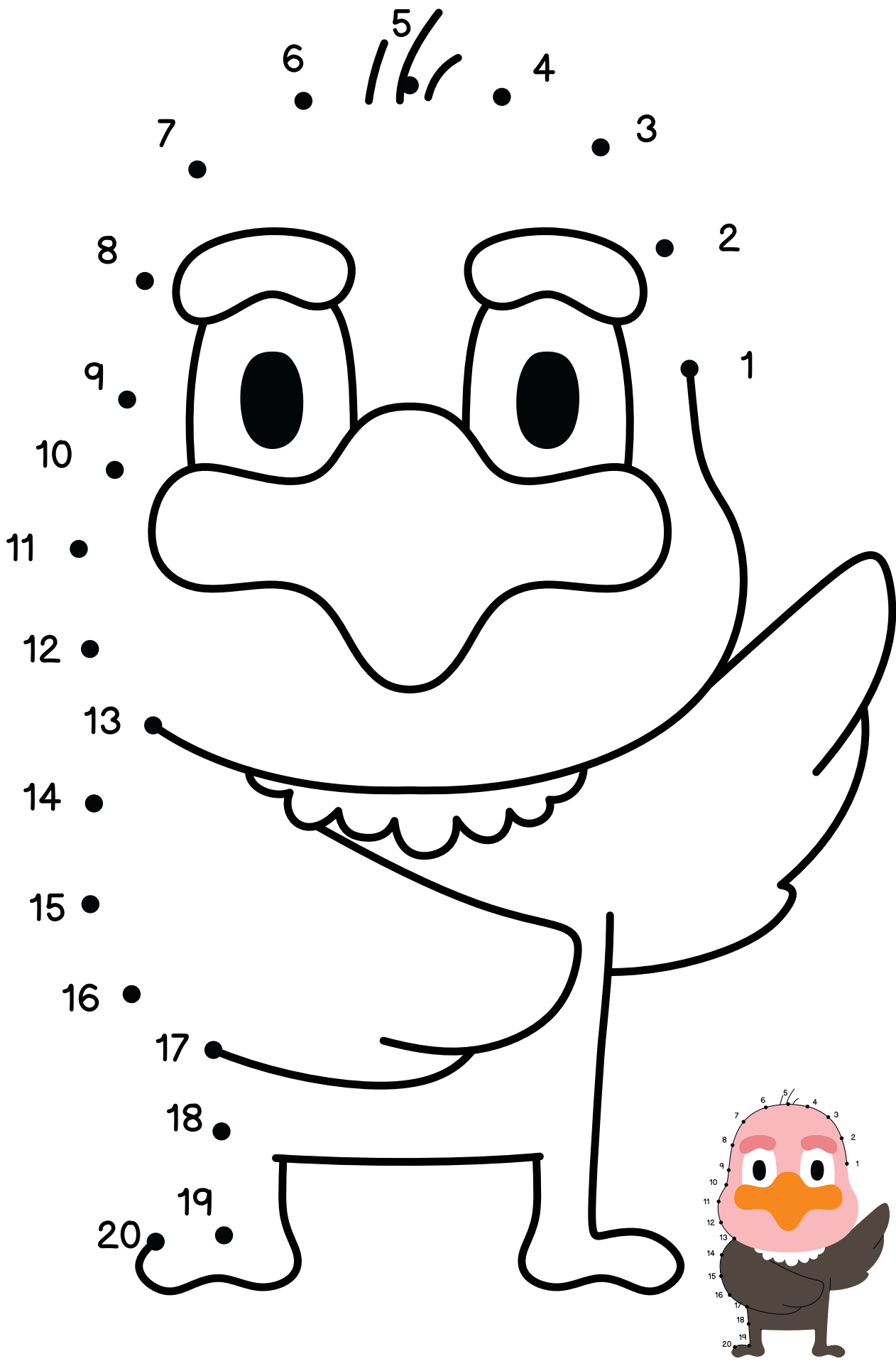

CONNECT THE DOTS

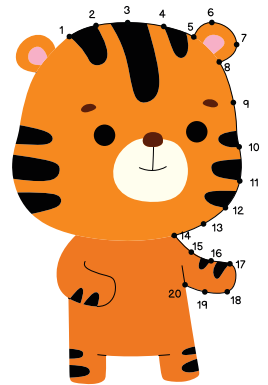
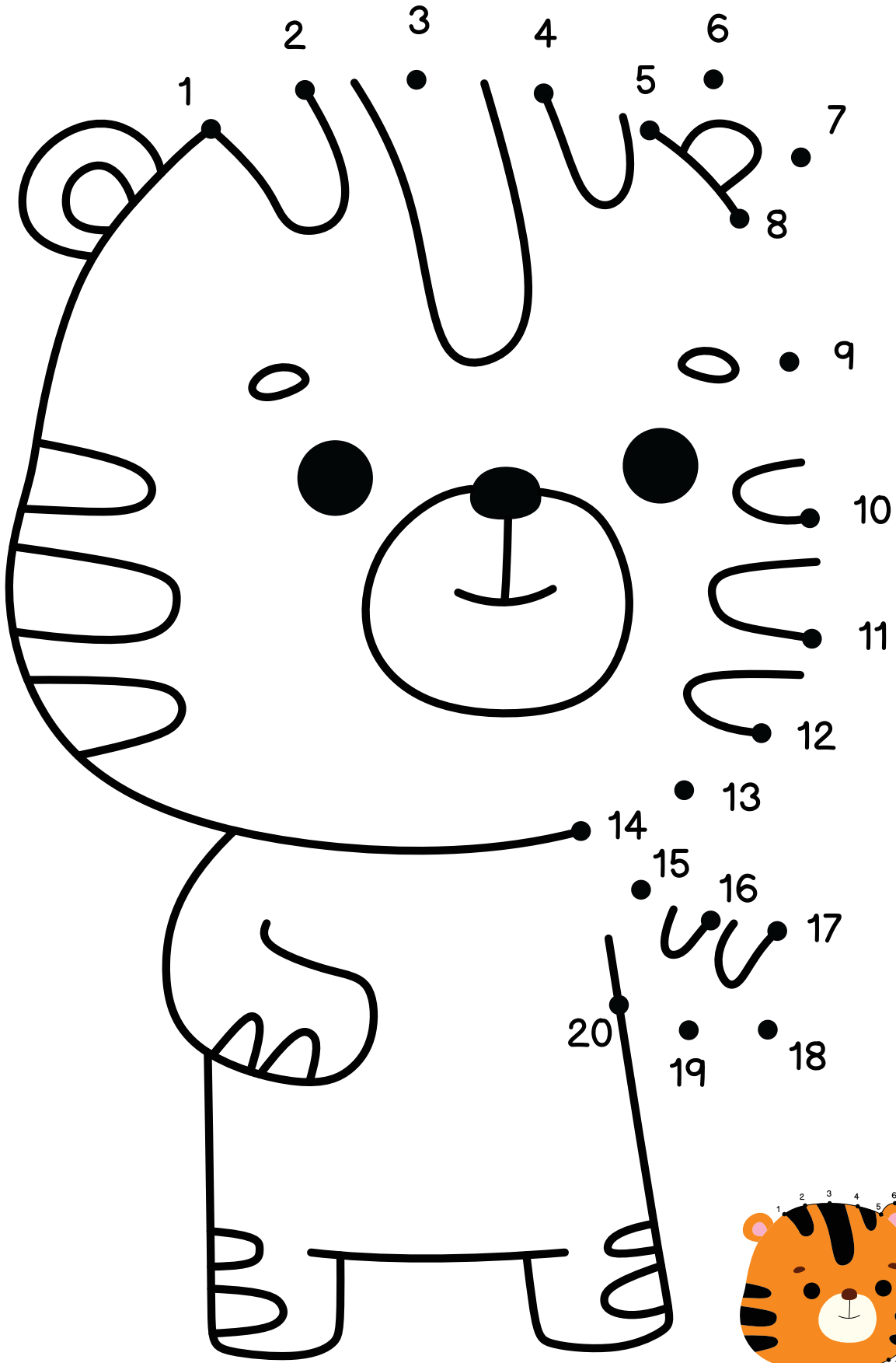

CONNECT THE DOTS



CONNECT THE DOTS

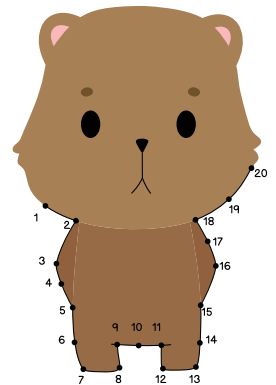
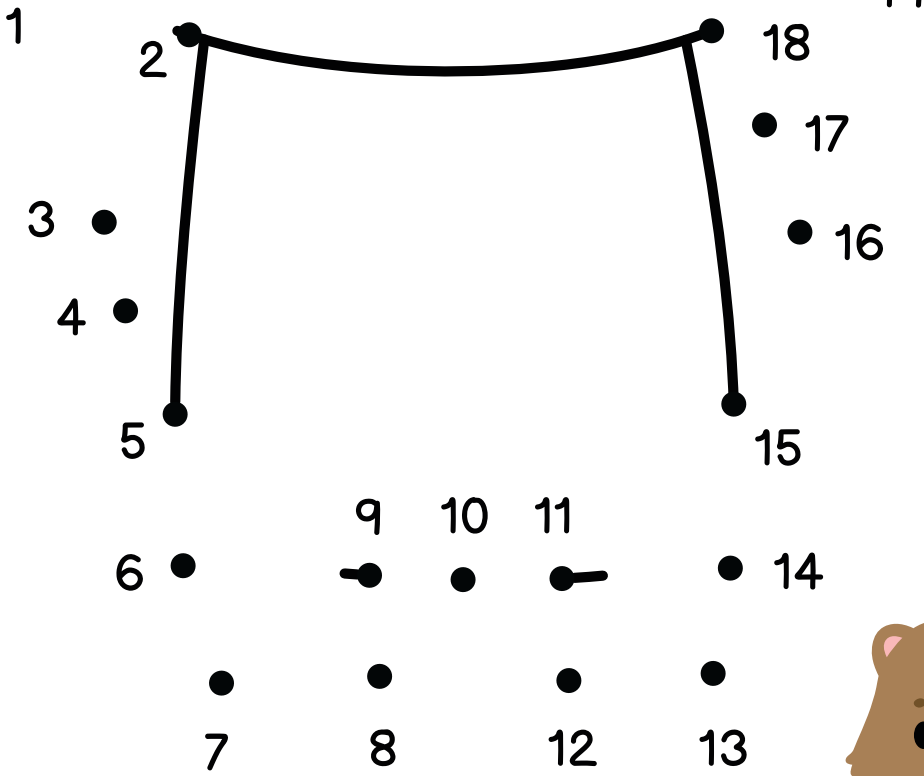
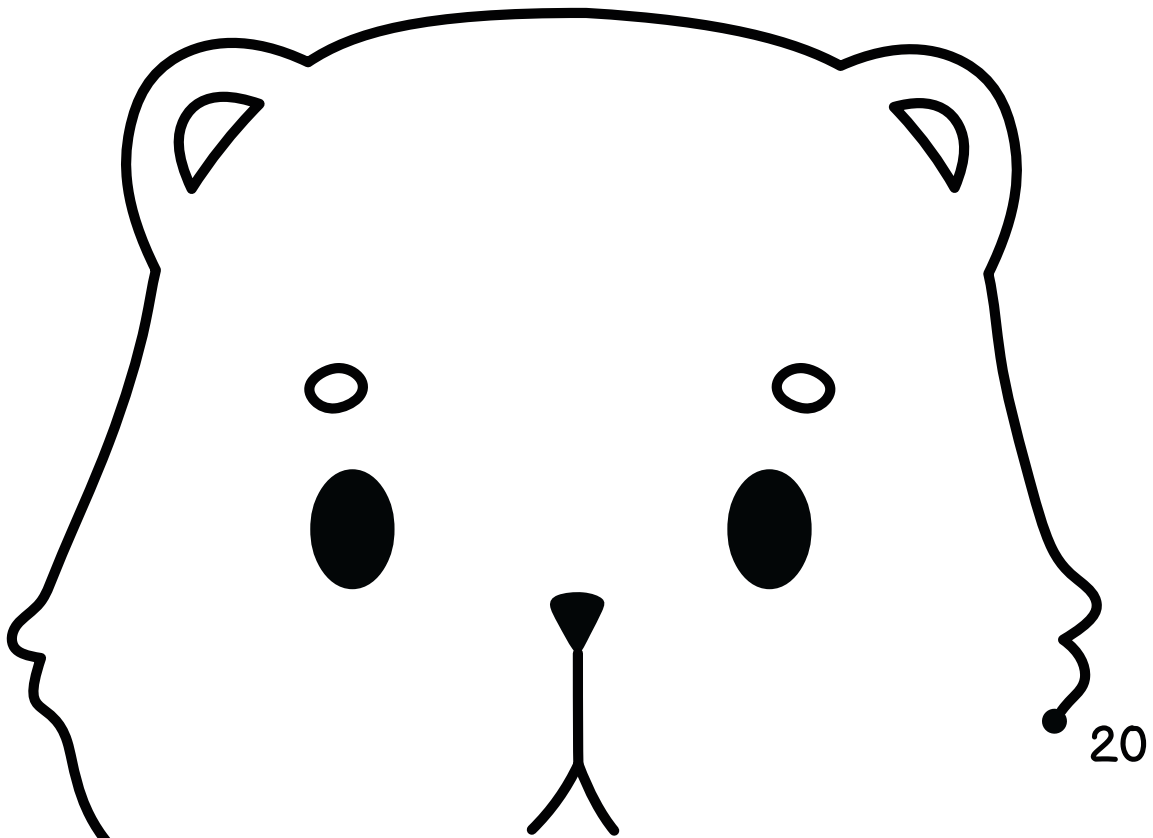

CONNECT THE DOTS

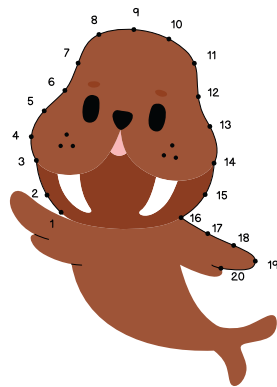
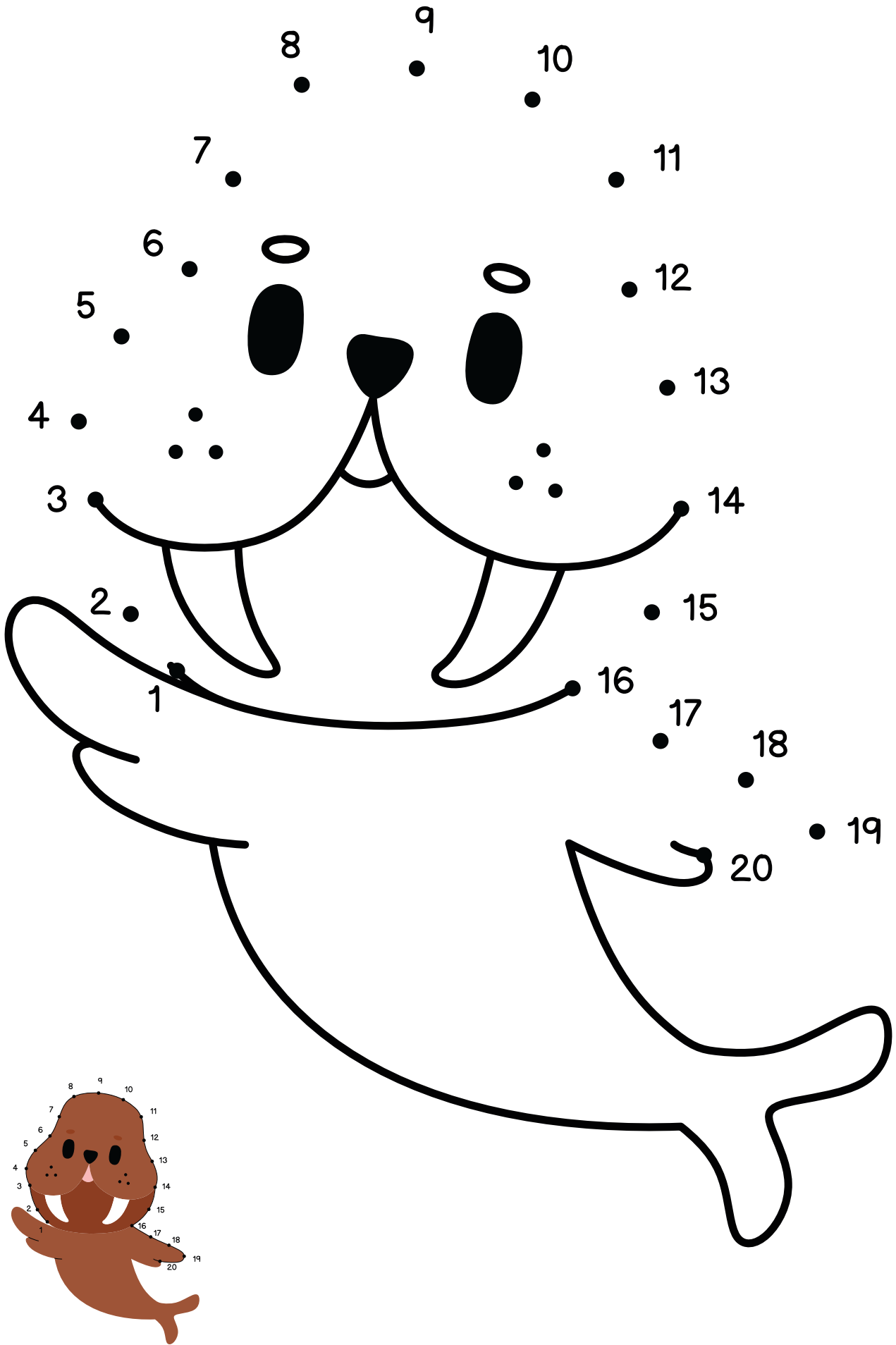

CONNECT THE DOTS

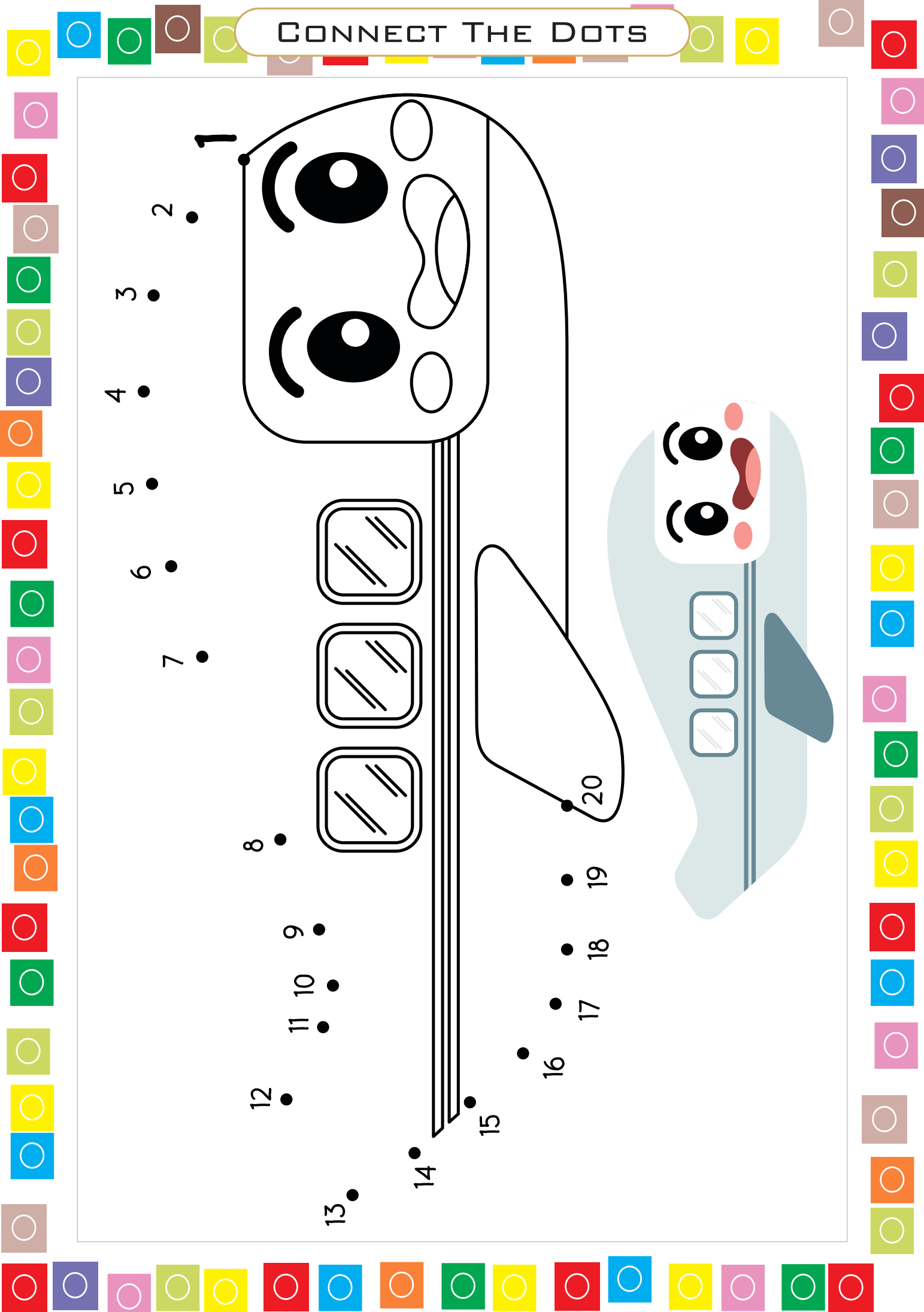
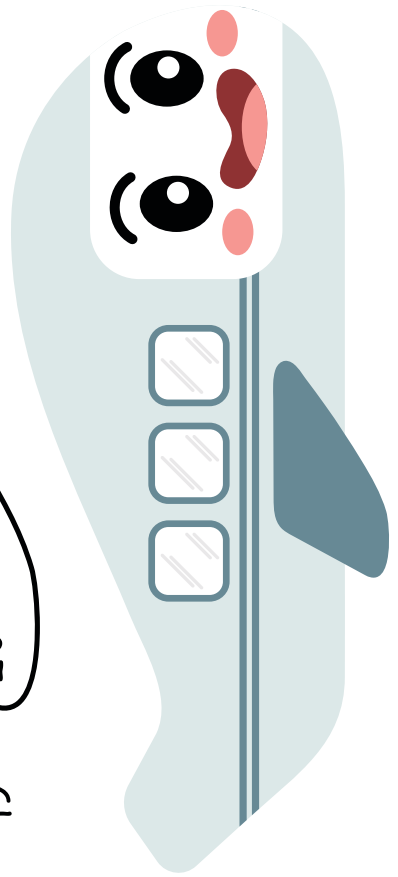
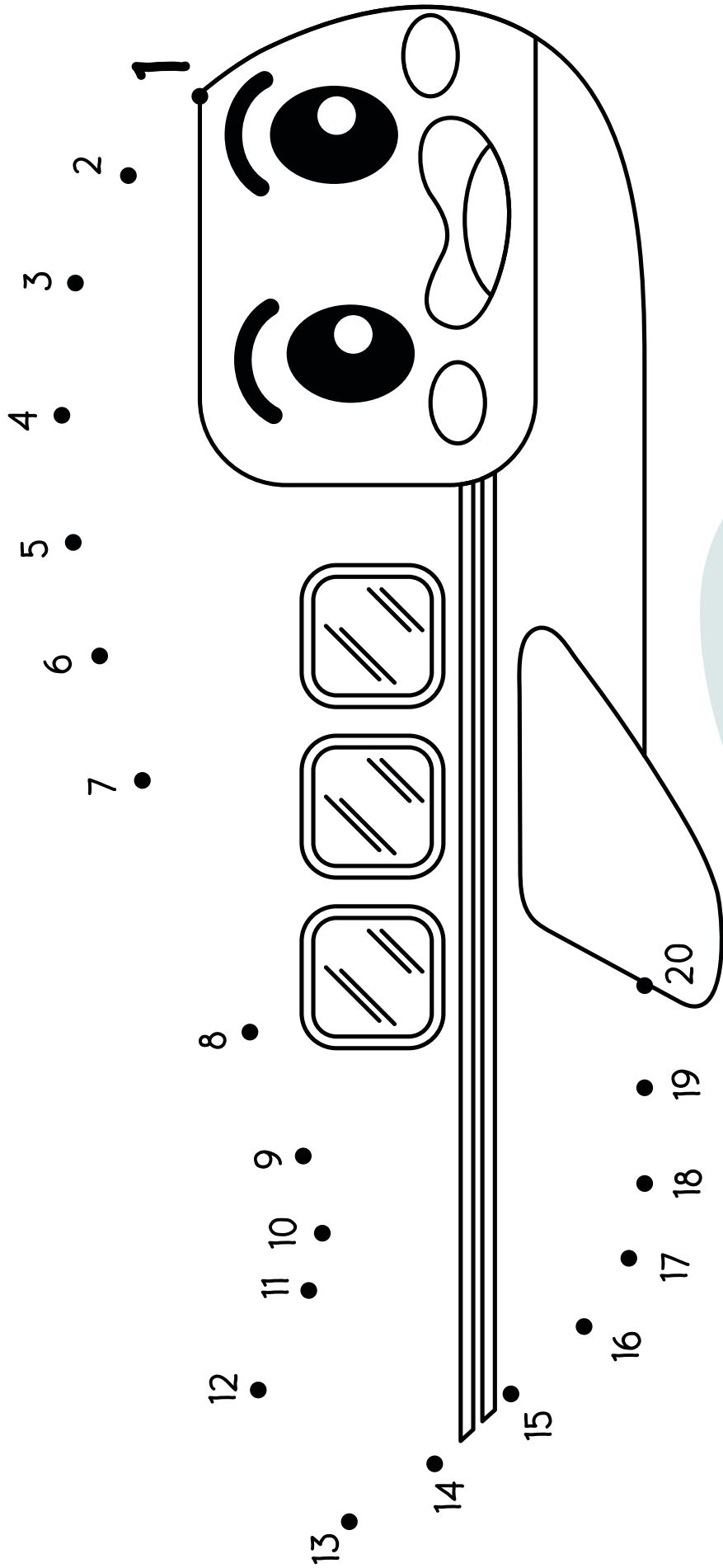

CONNECT THE DOTS

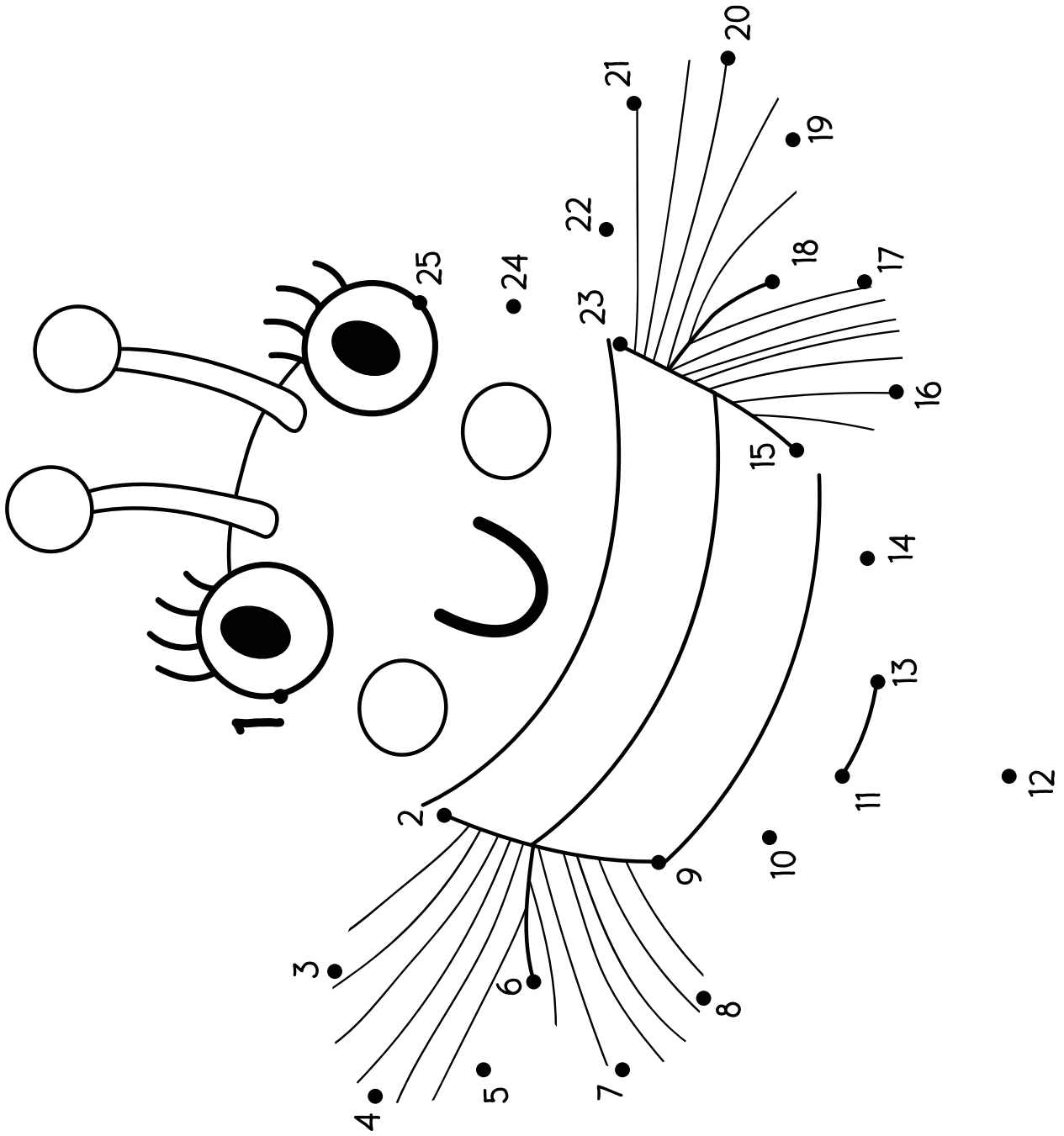
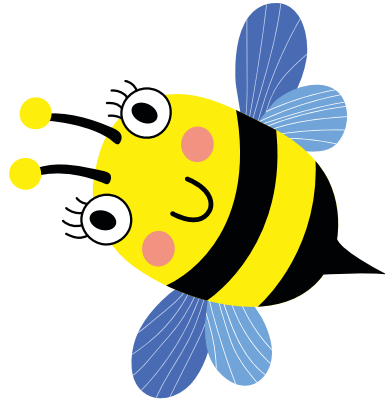

CONNECT THE DOTS

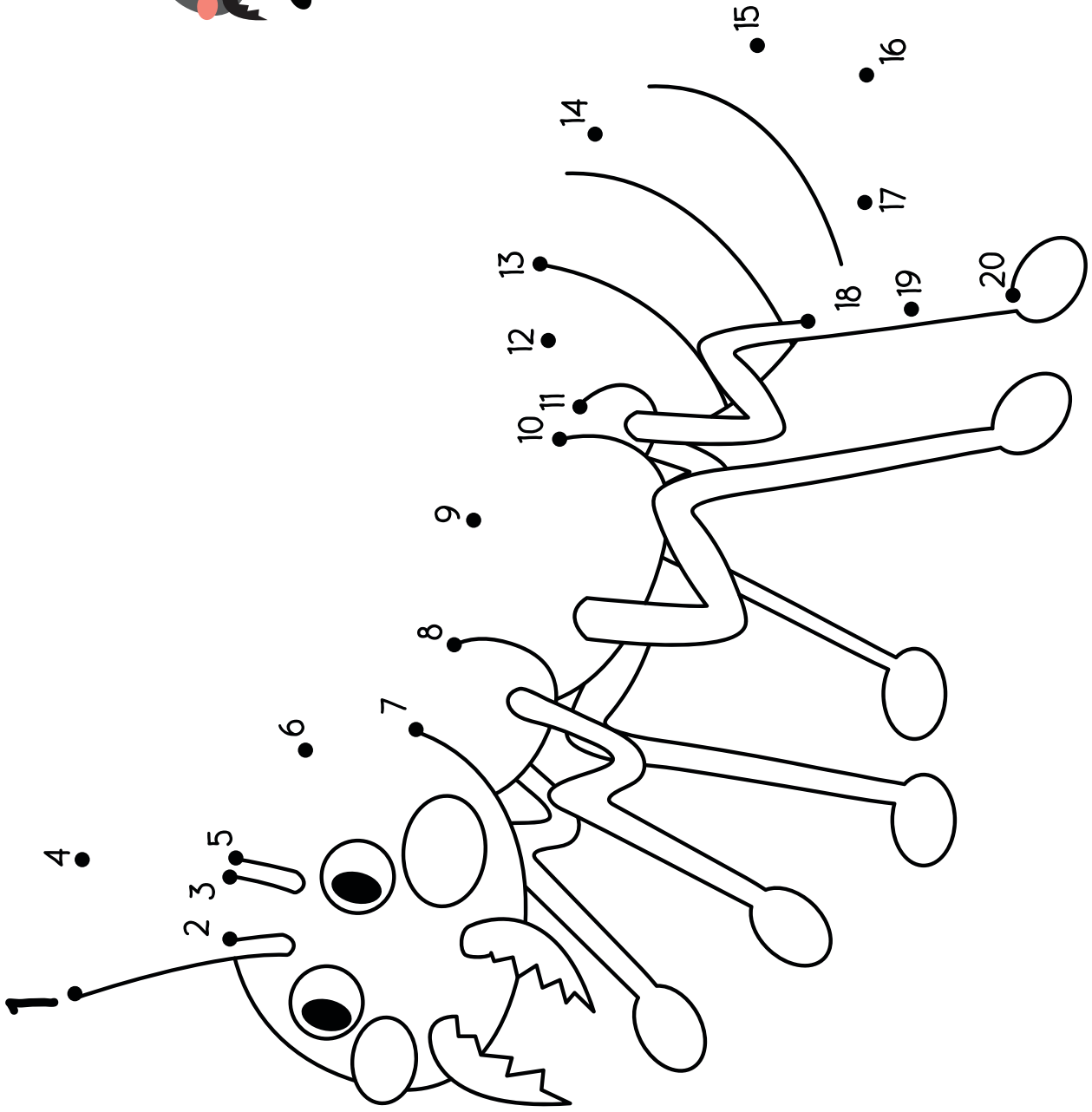
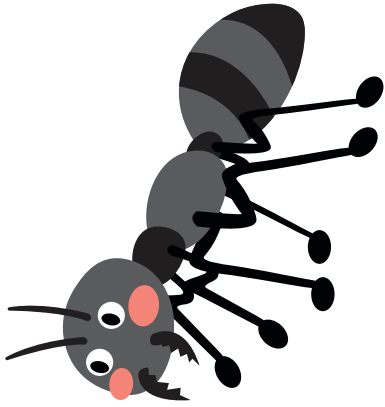

CONNECT THE DOTS

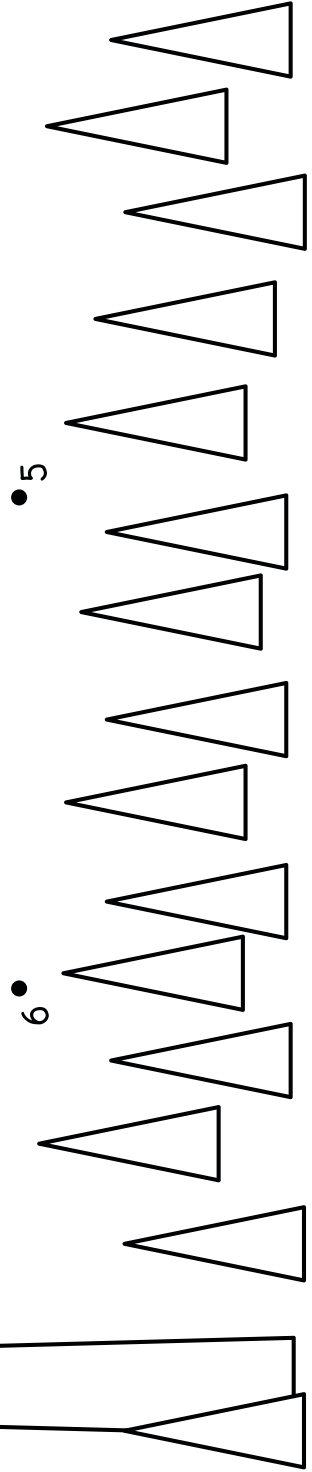
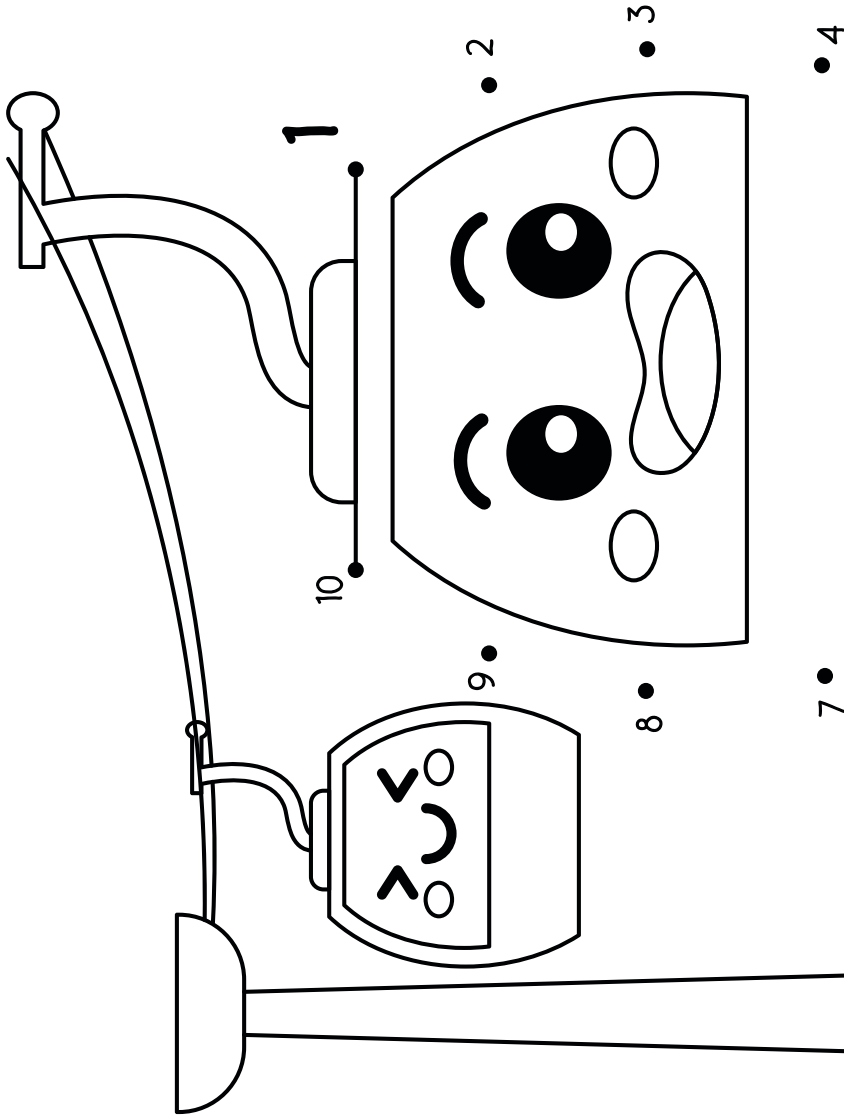
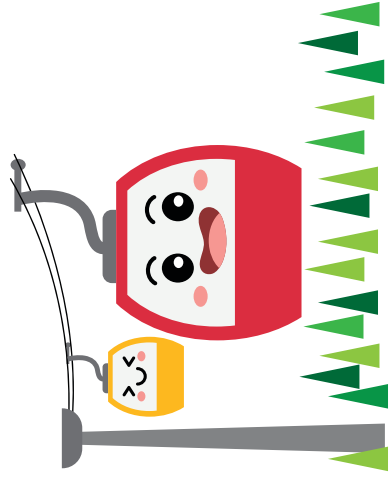

CONNECT THE DOTS

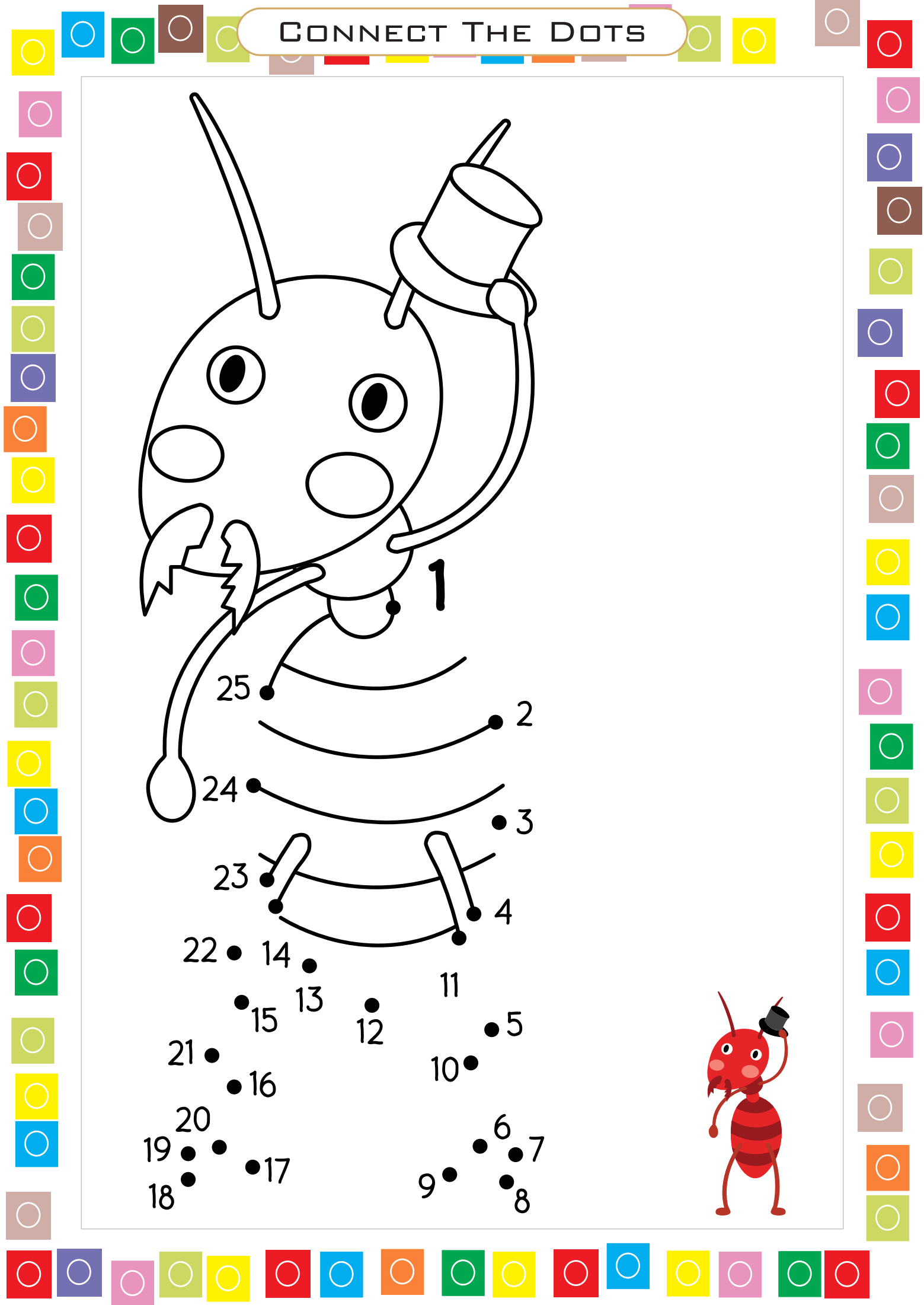
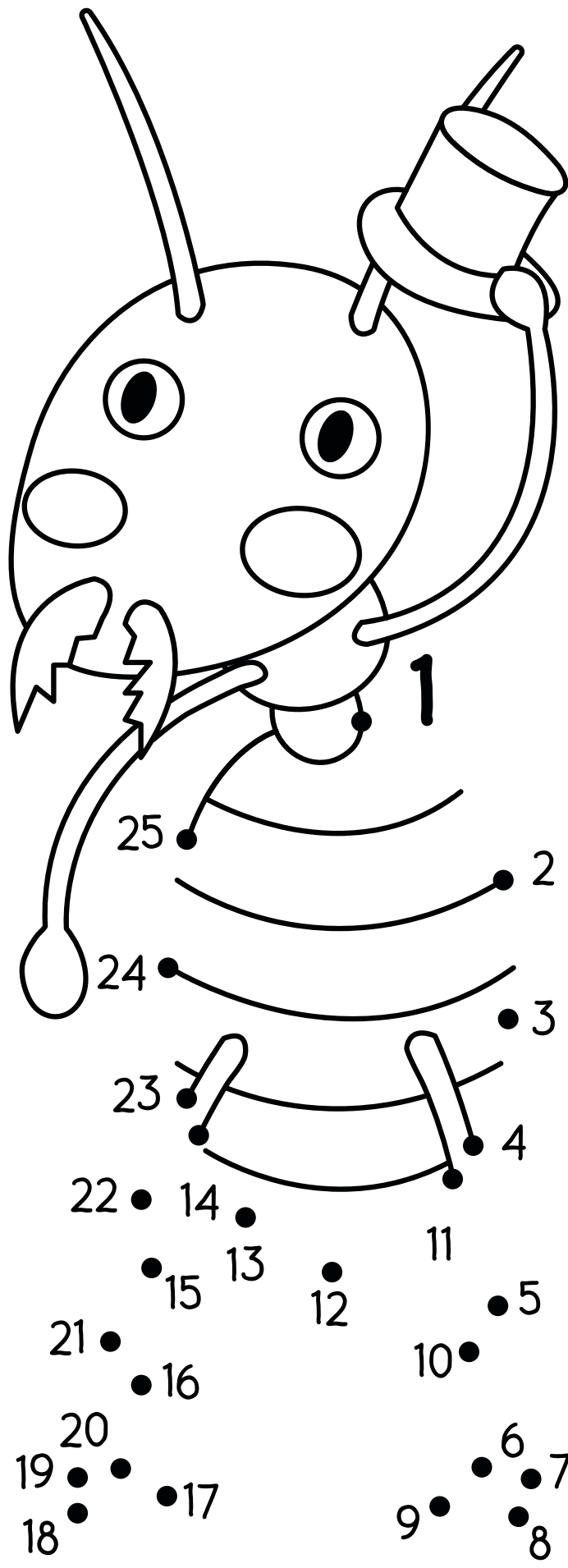

CONNECT THE DOTS

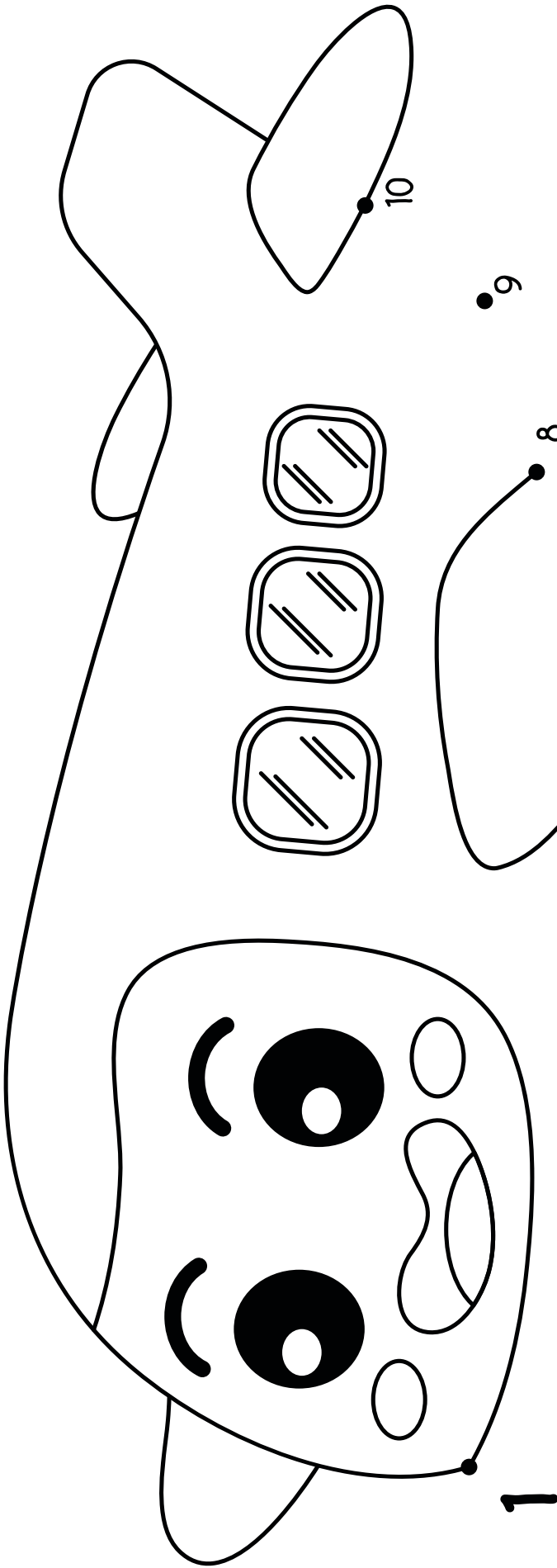

2 3



5

7

6

9

8

4

10

CONNECT THE DOTS

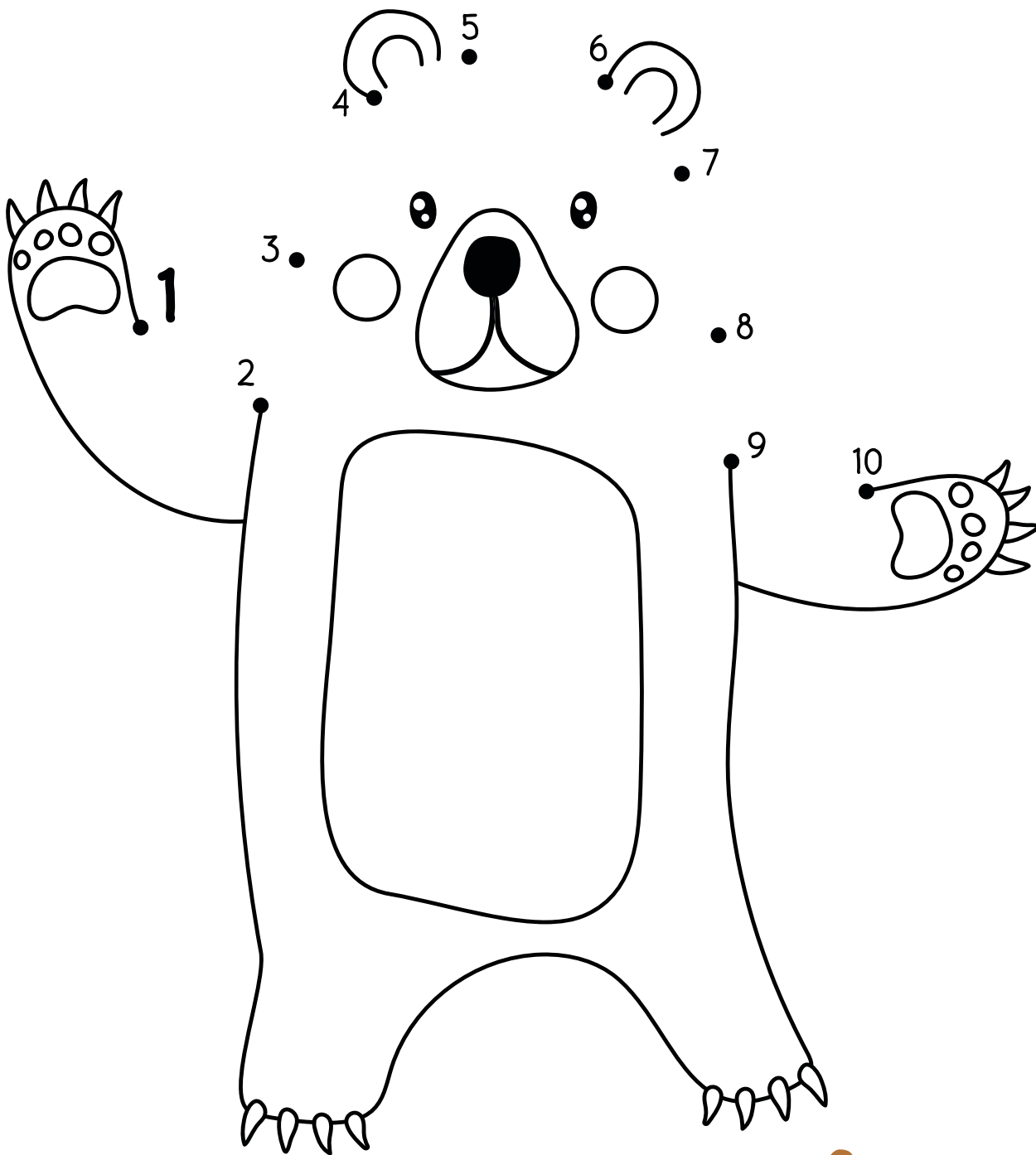

CONNECT THE DOTS

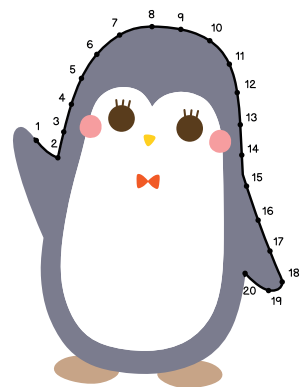
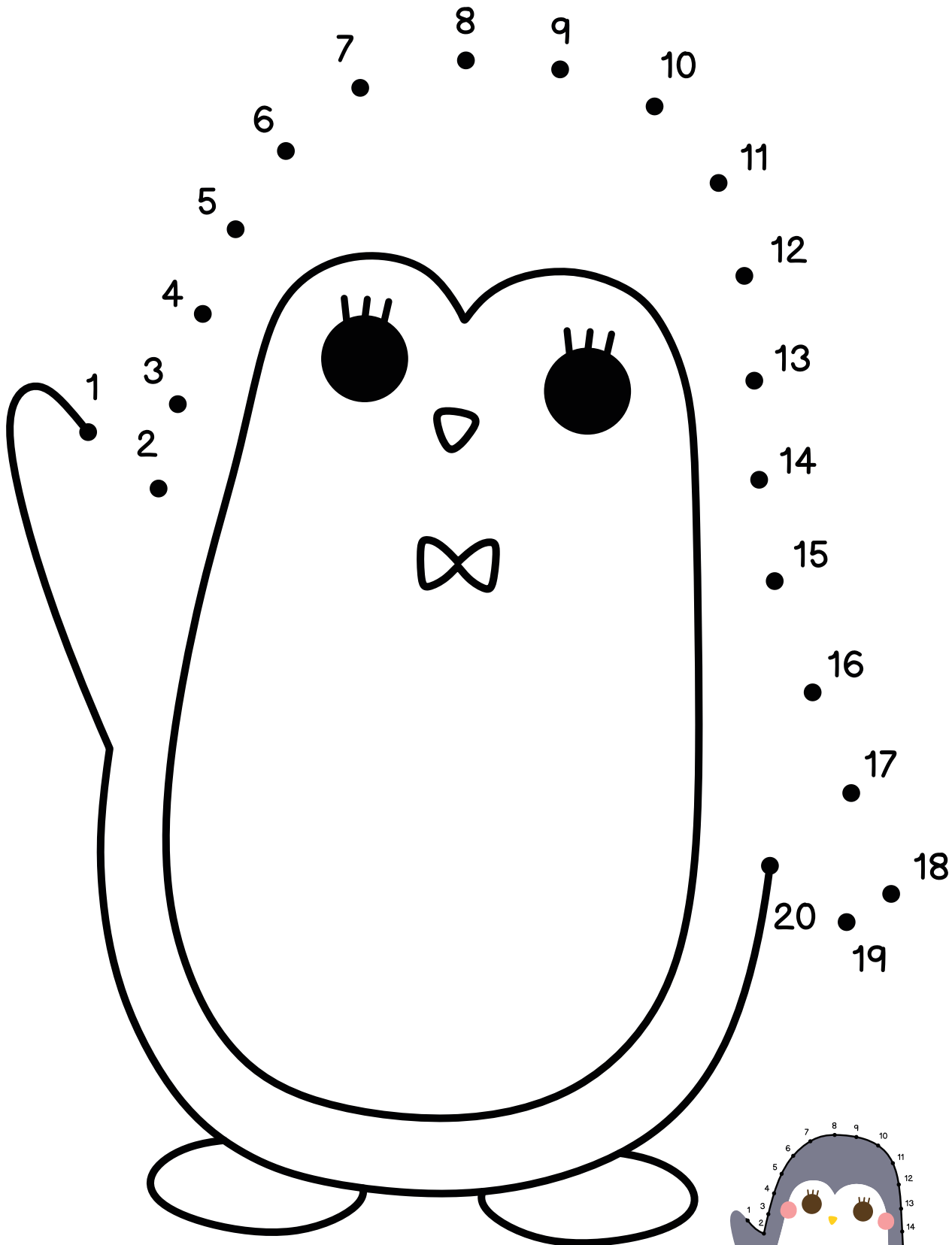

CONNECT THE DOTS

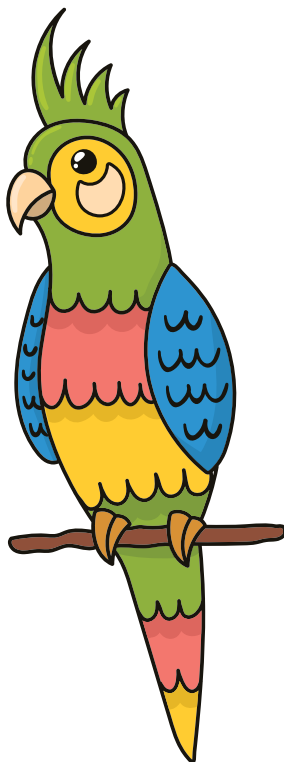
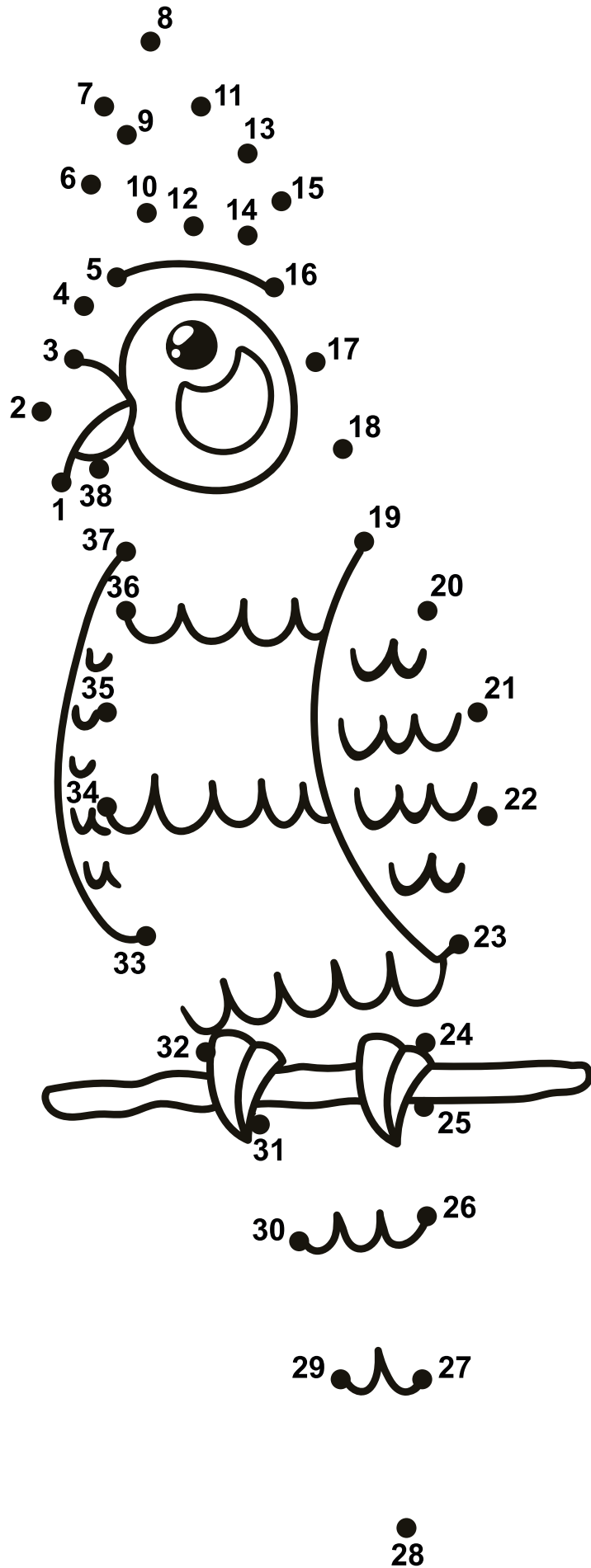

CONNECT THE DOTS

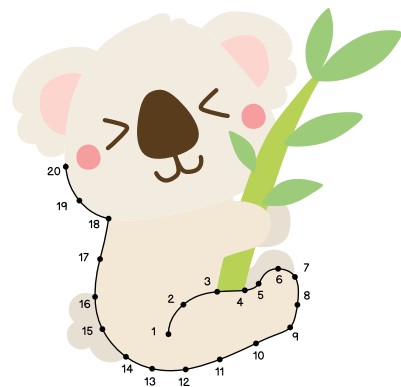

CONNECT THE DOTS

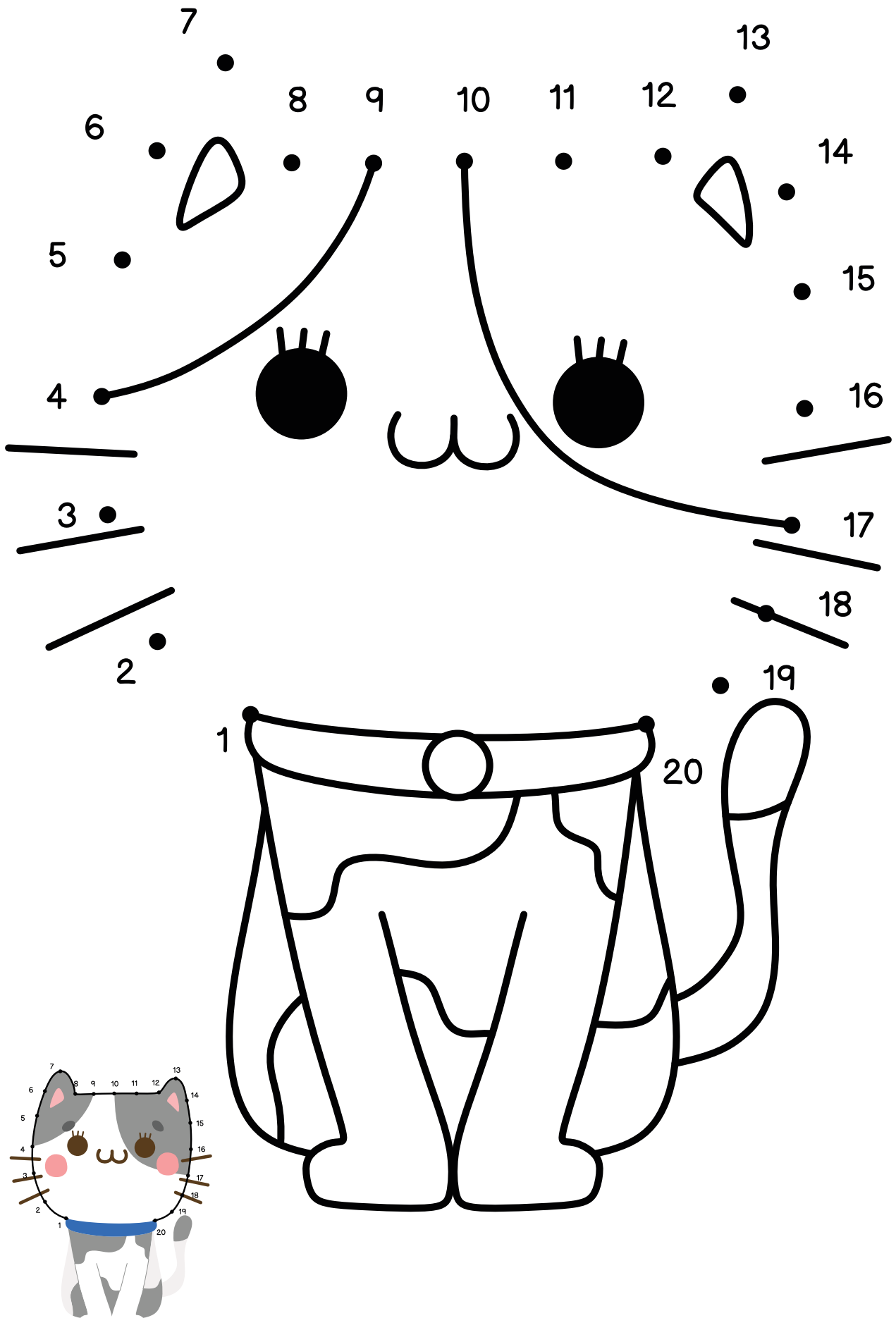

CONNECT THE DOTS

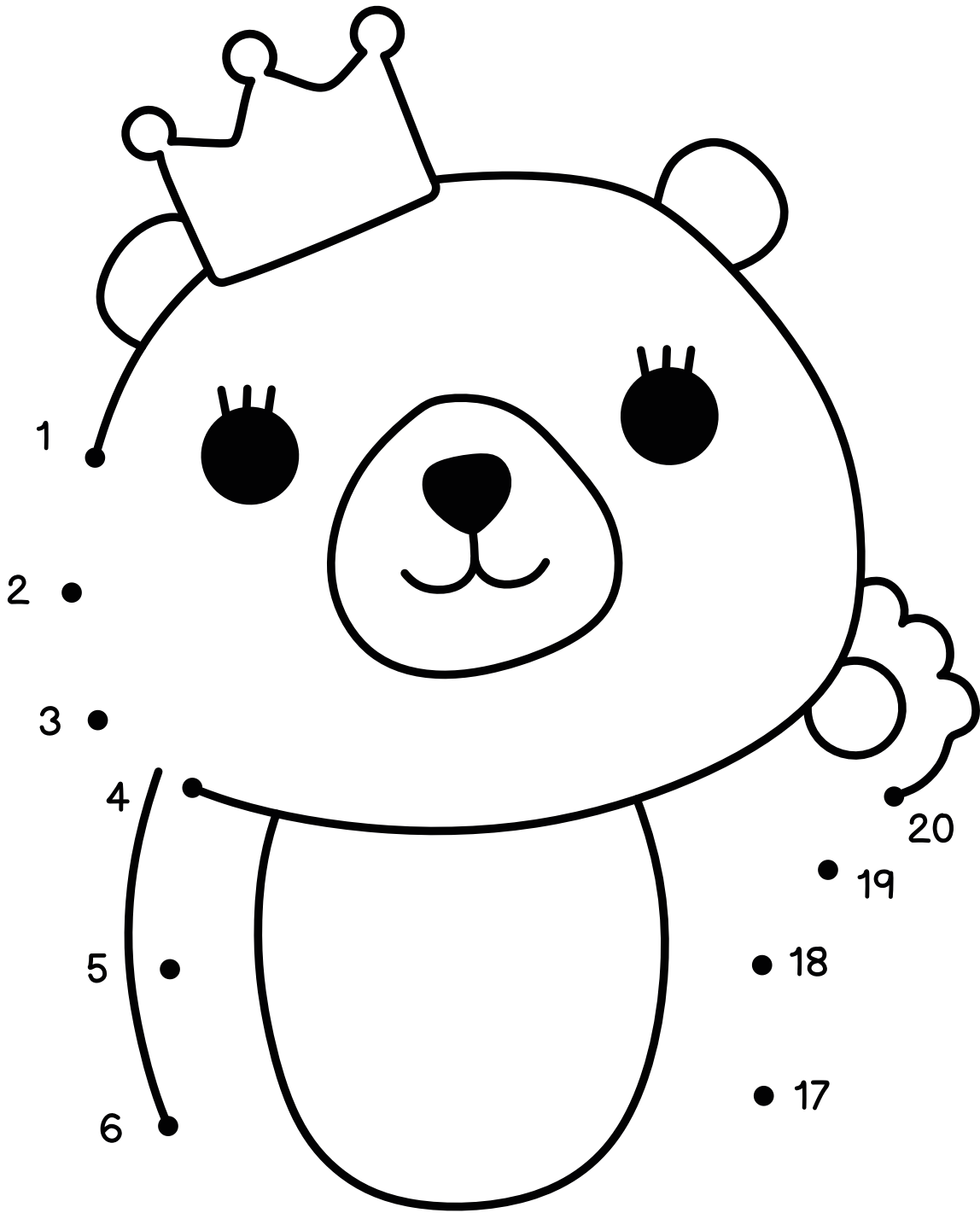

CONNECT THE DOTS

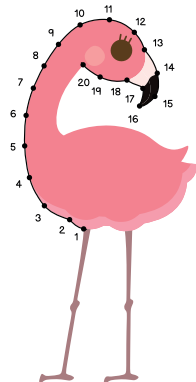
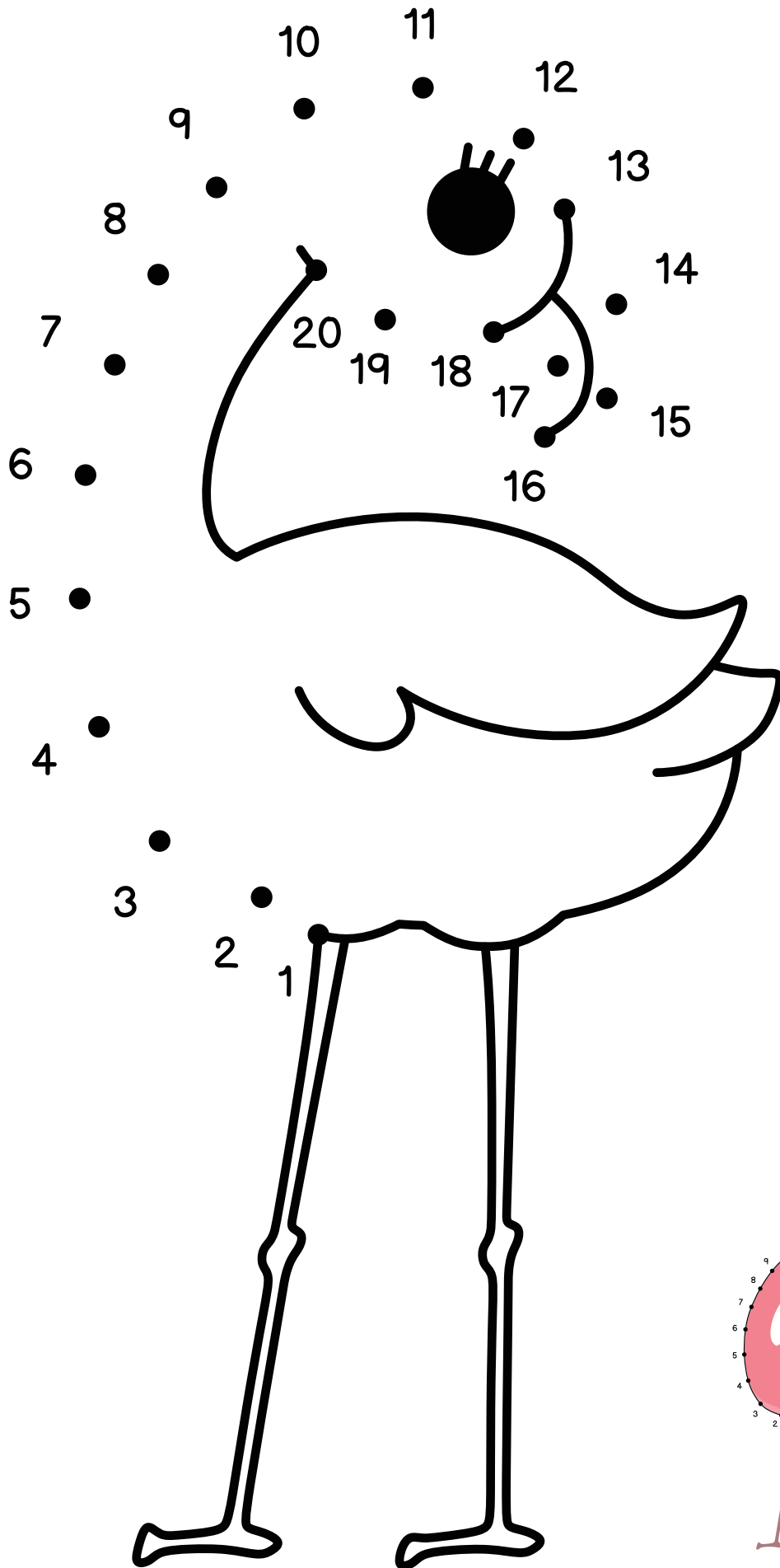

CONNECT THE DOTS

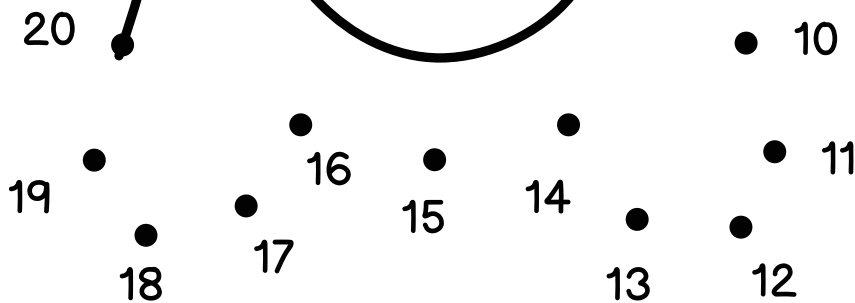
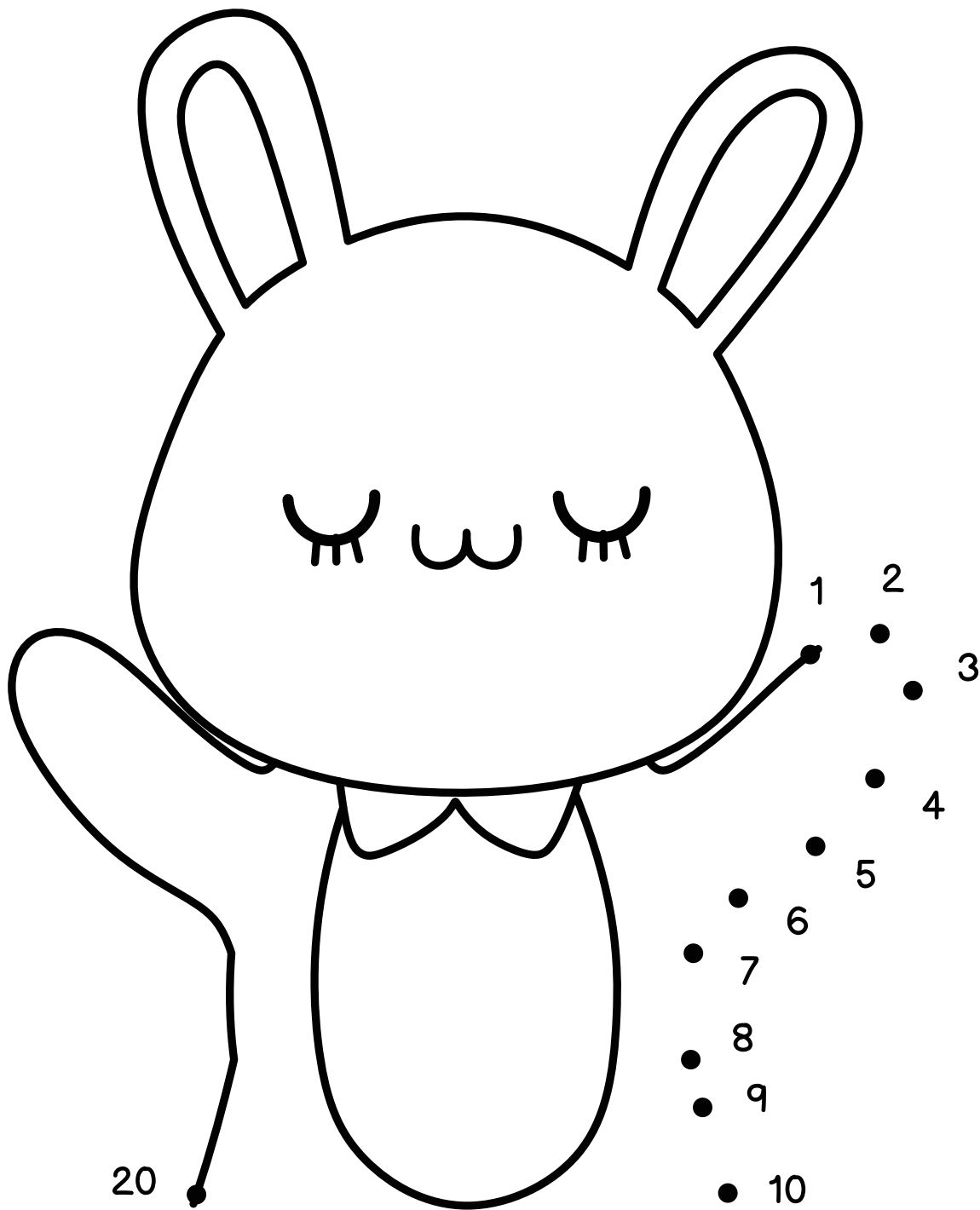

CONNECT THE DOTS

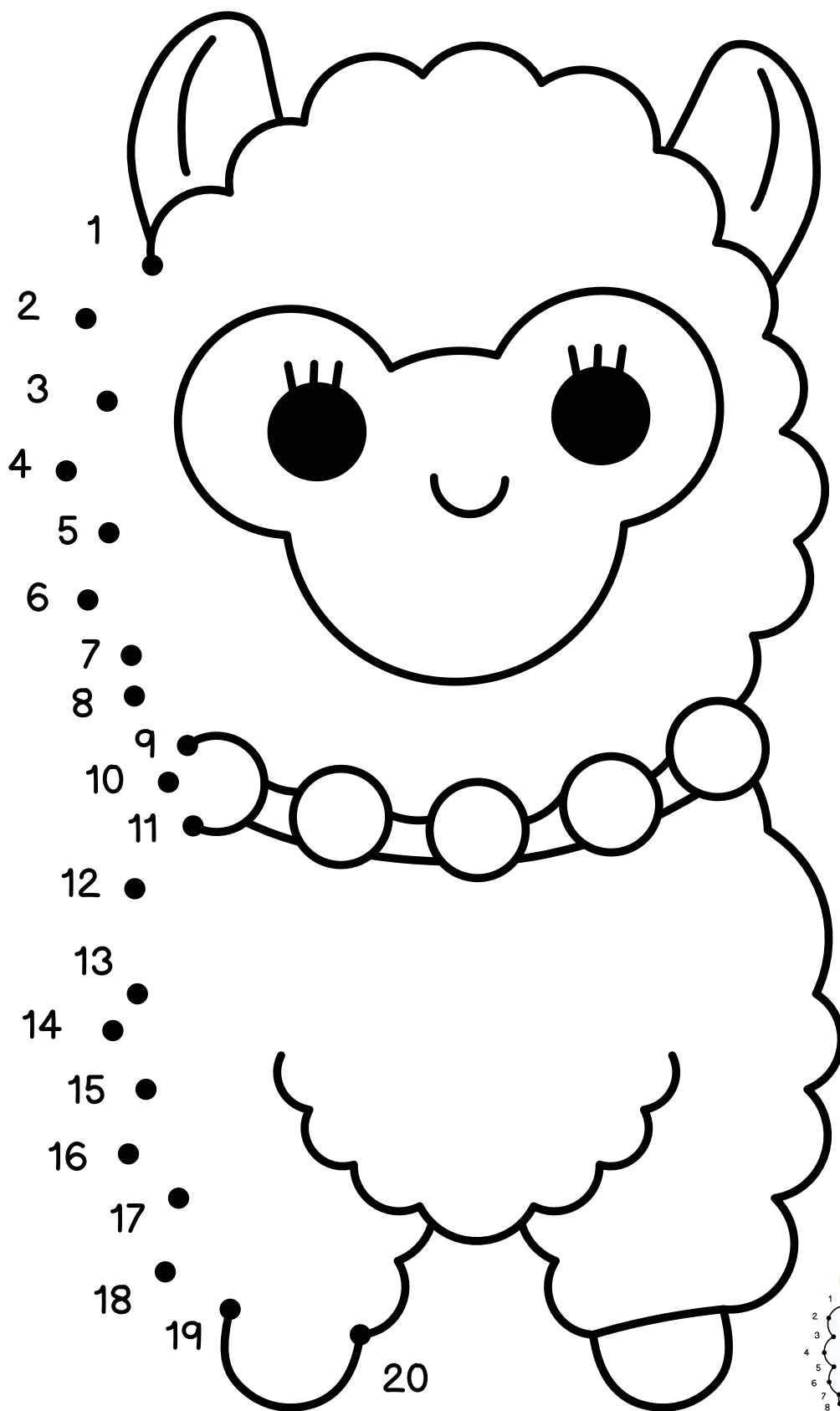

CONNECT THE DOTS

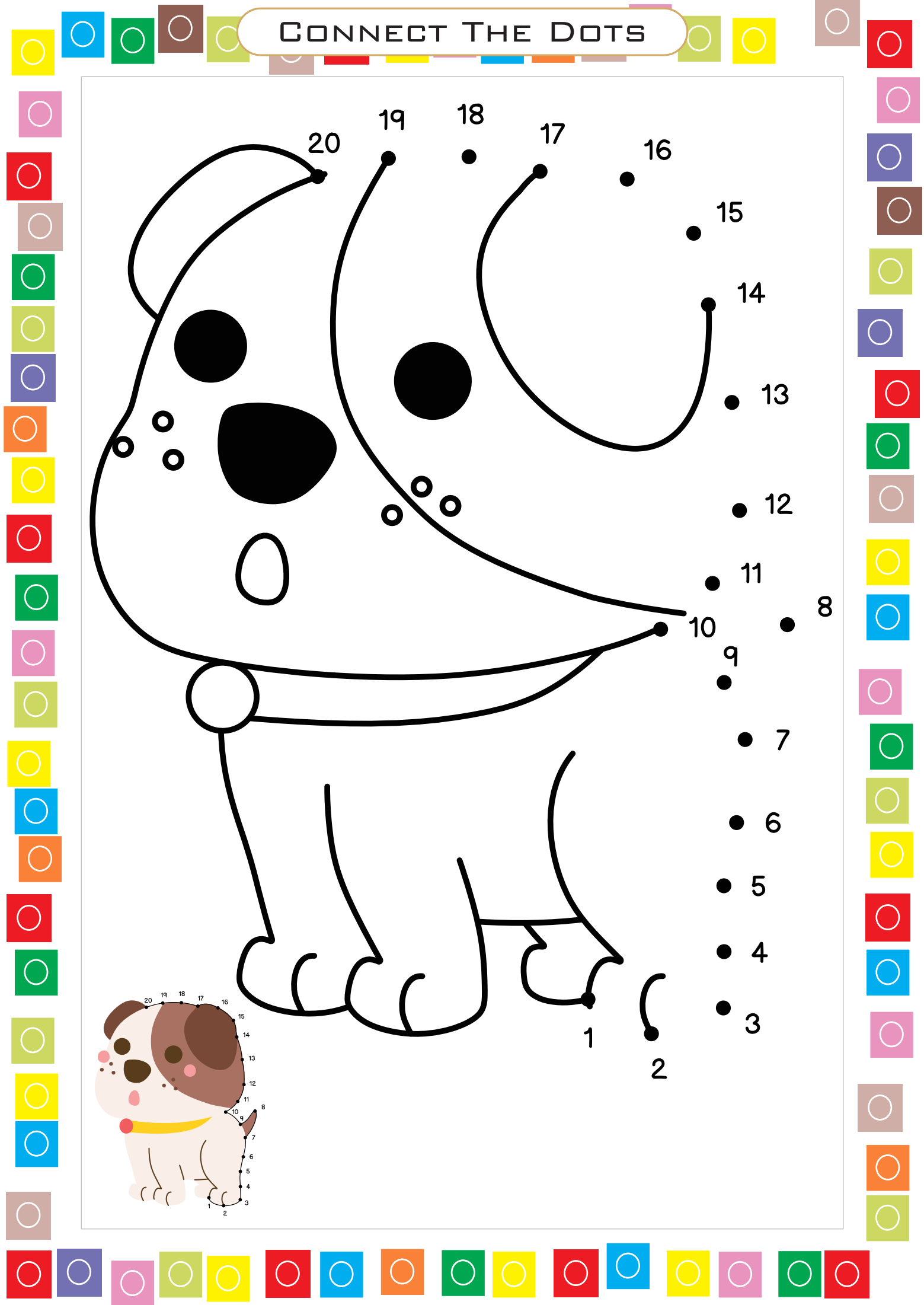
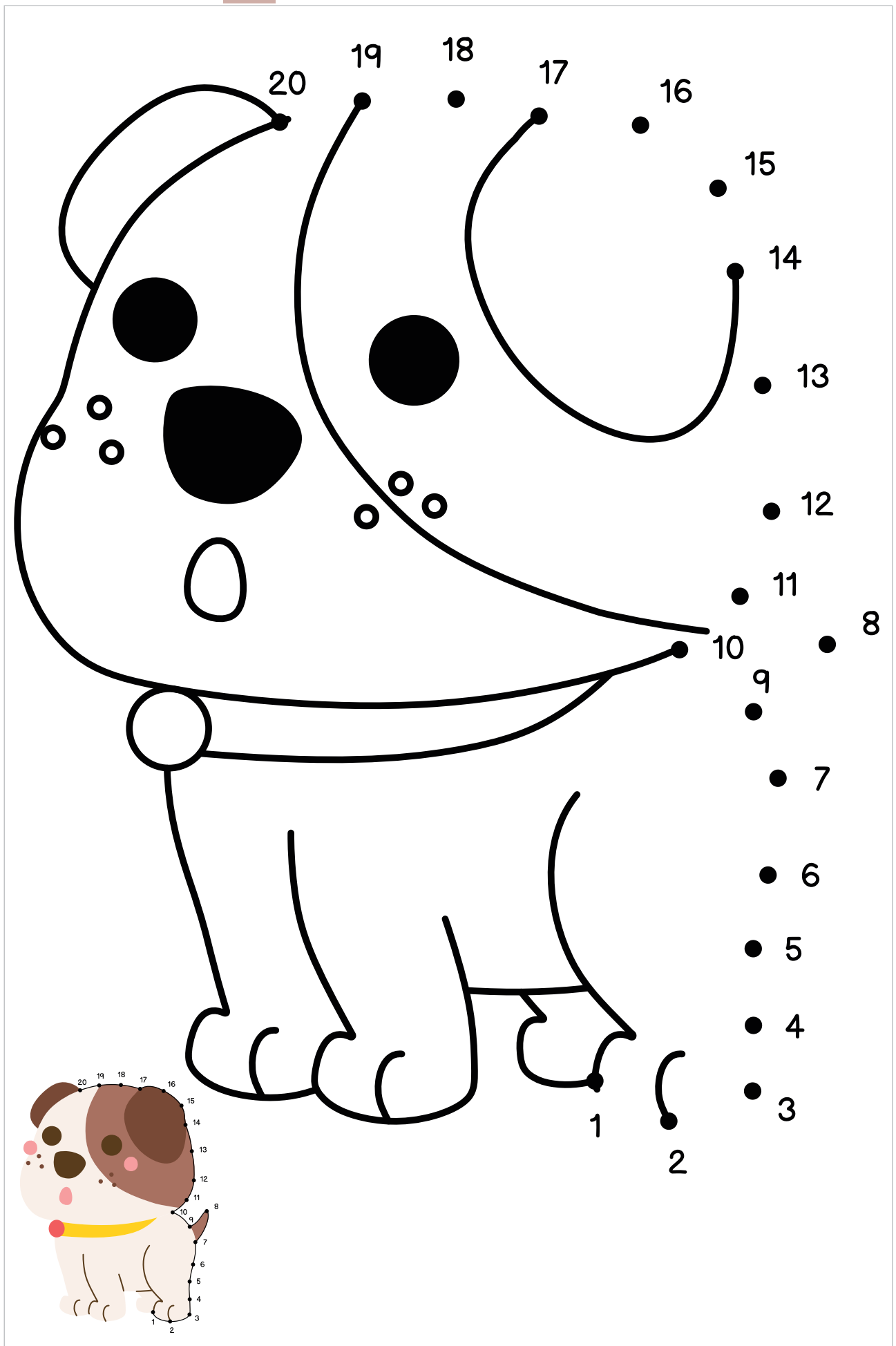

CONNECT THE DOTS

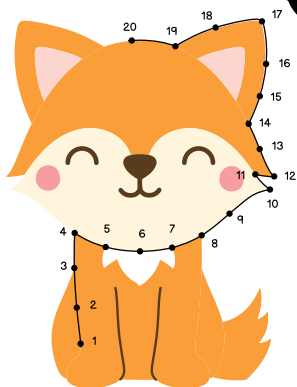
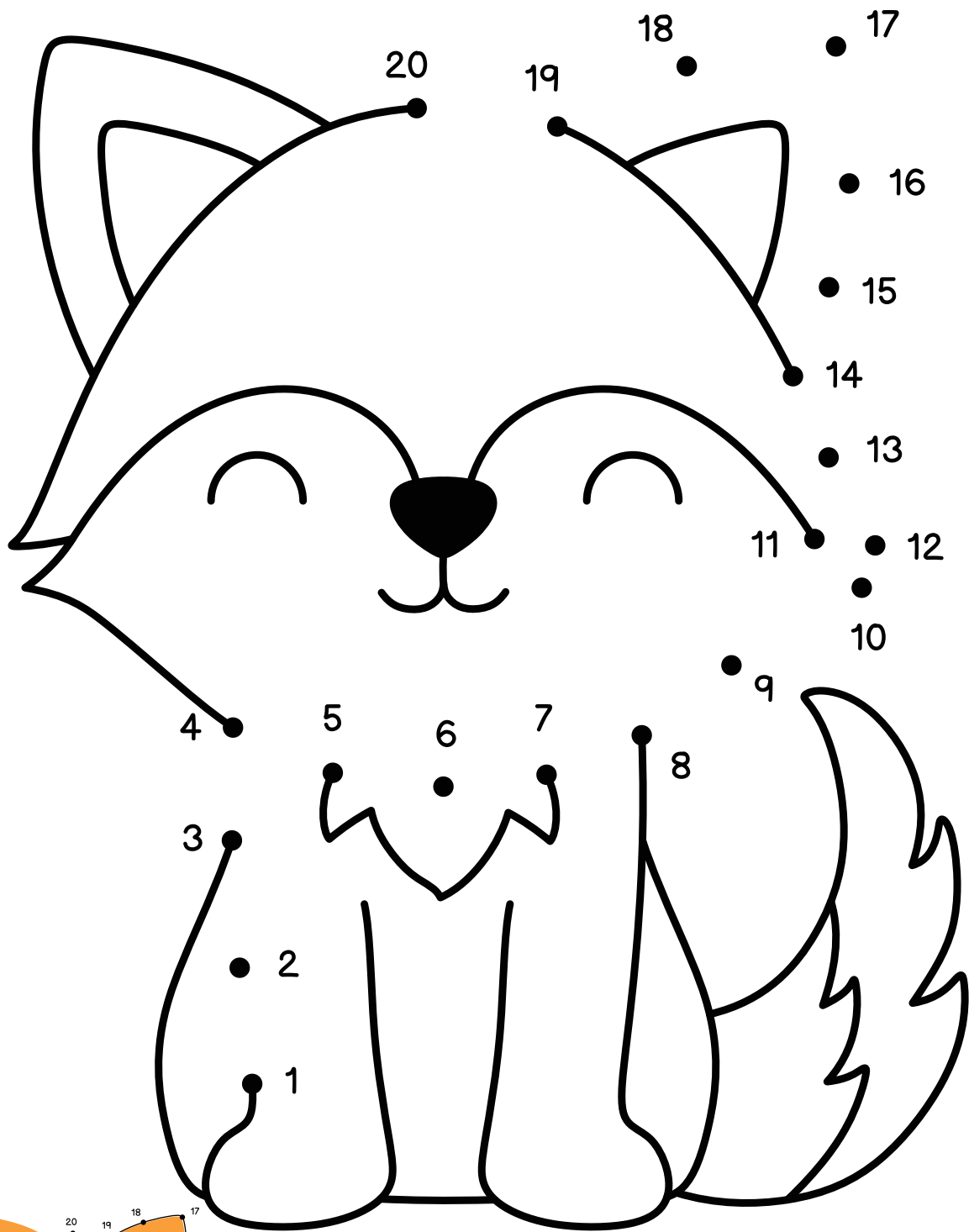

CONNECT THE DOTS

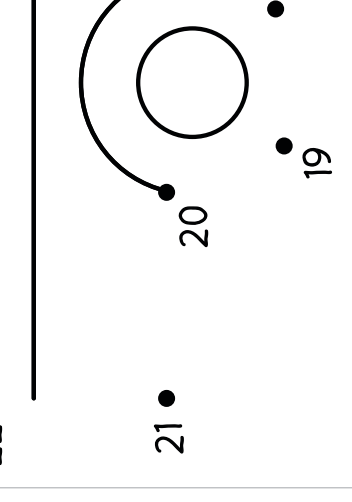
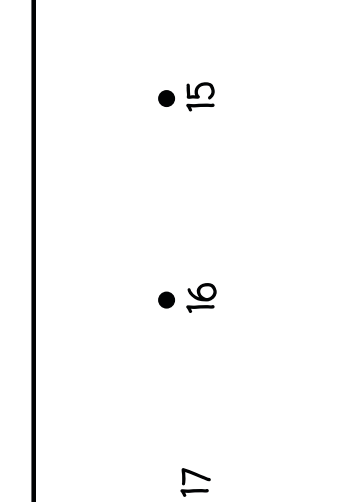
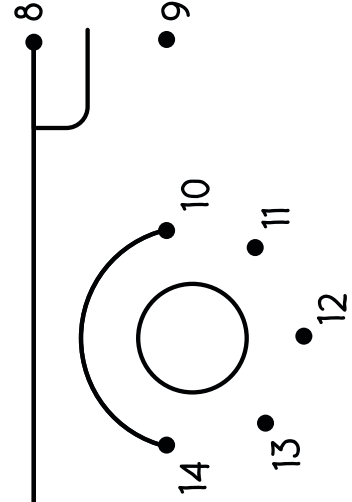
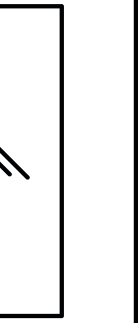
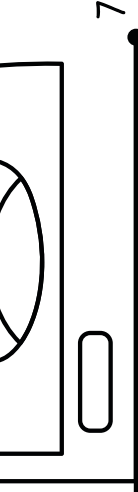
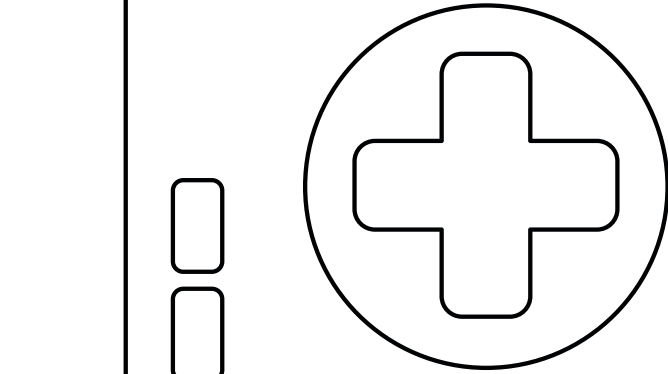
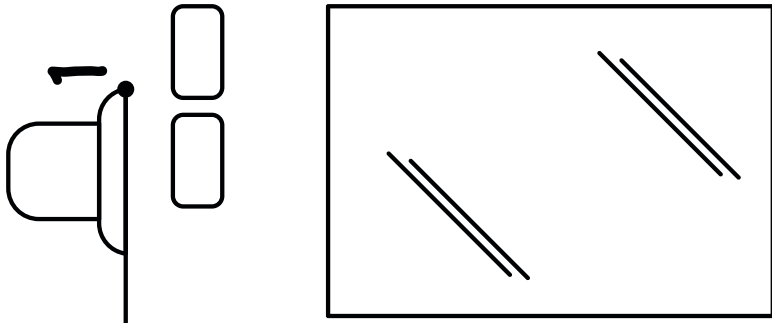
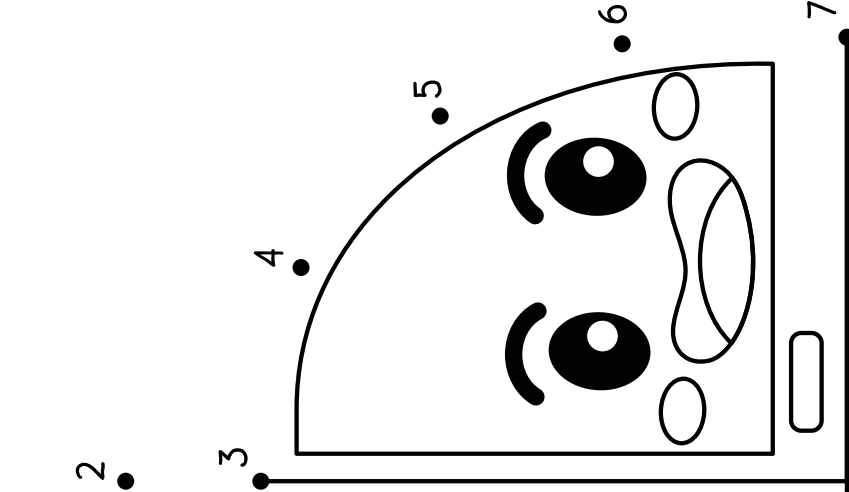
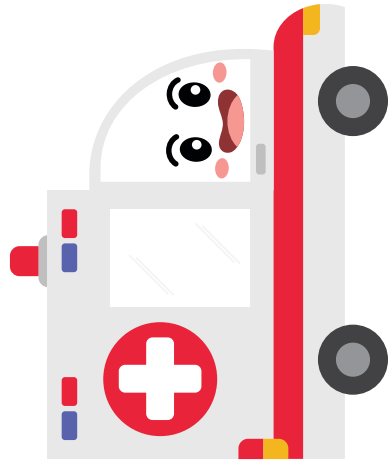

CONNECT THE DOTS

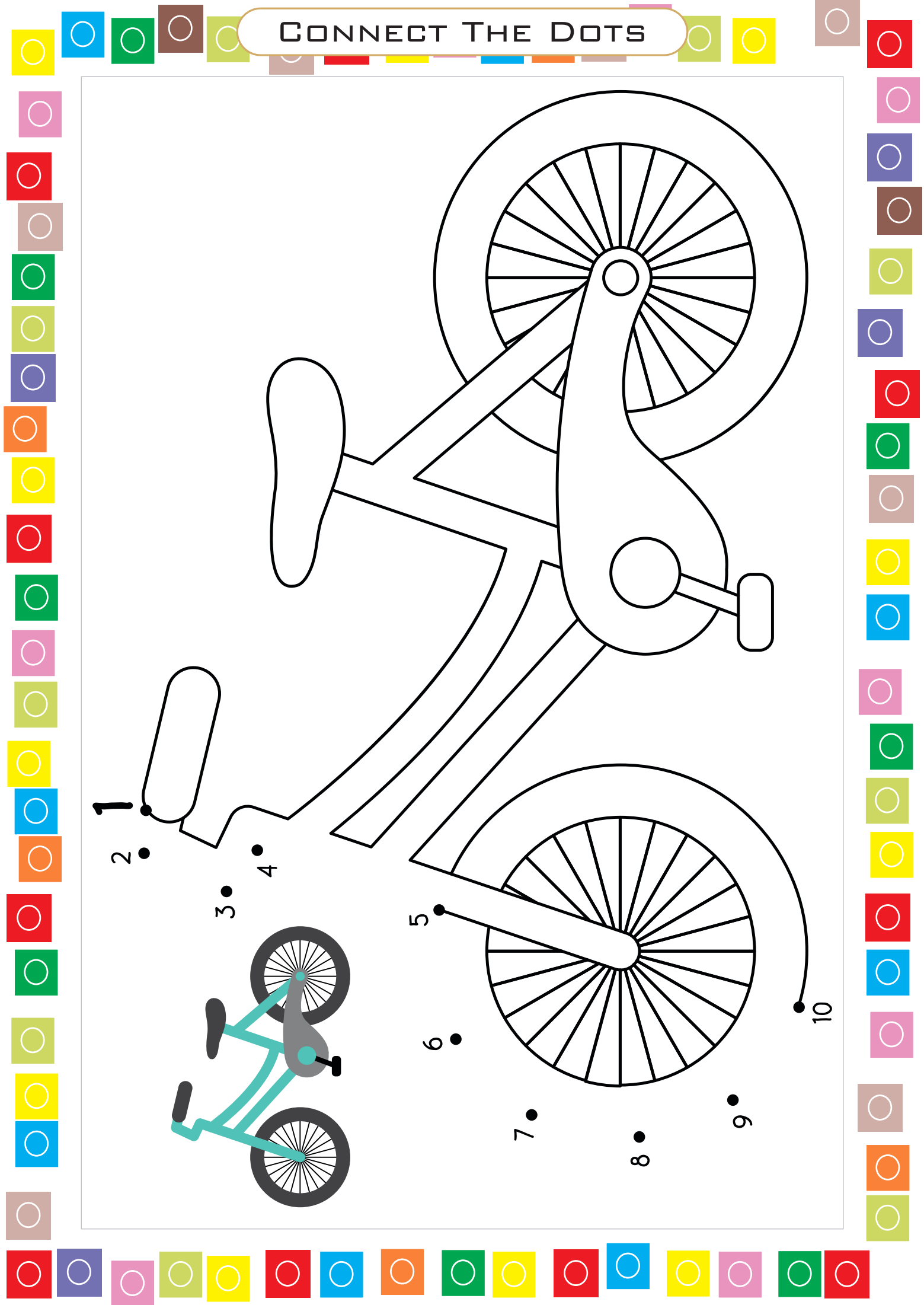
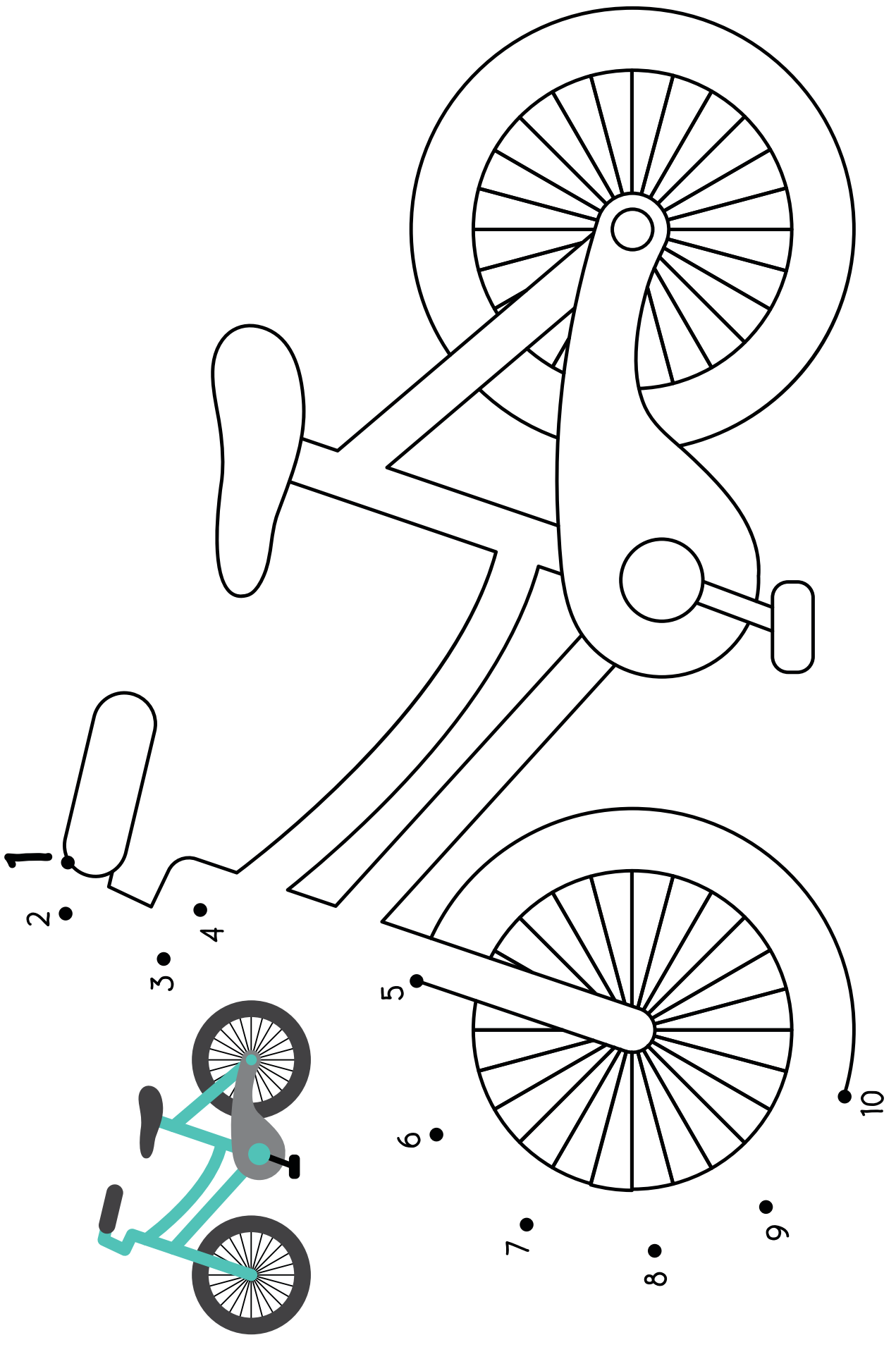

CONNECT THE DOTS

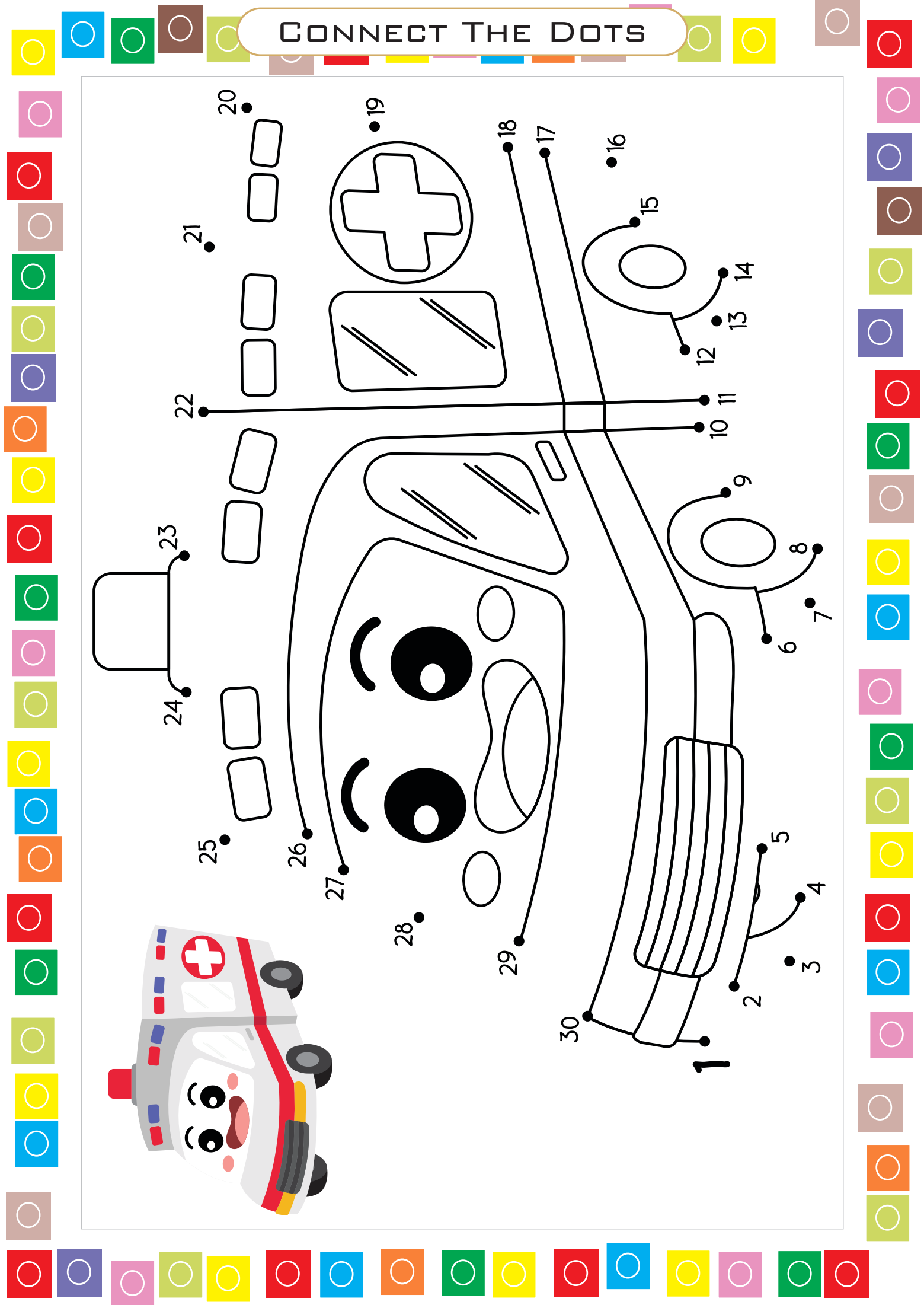
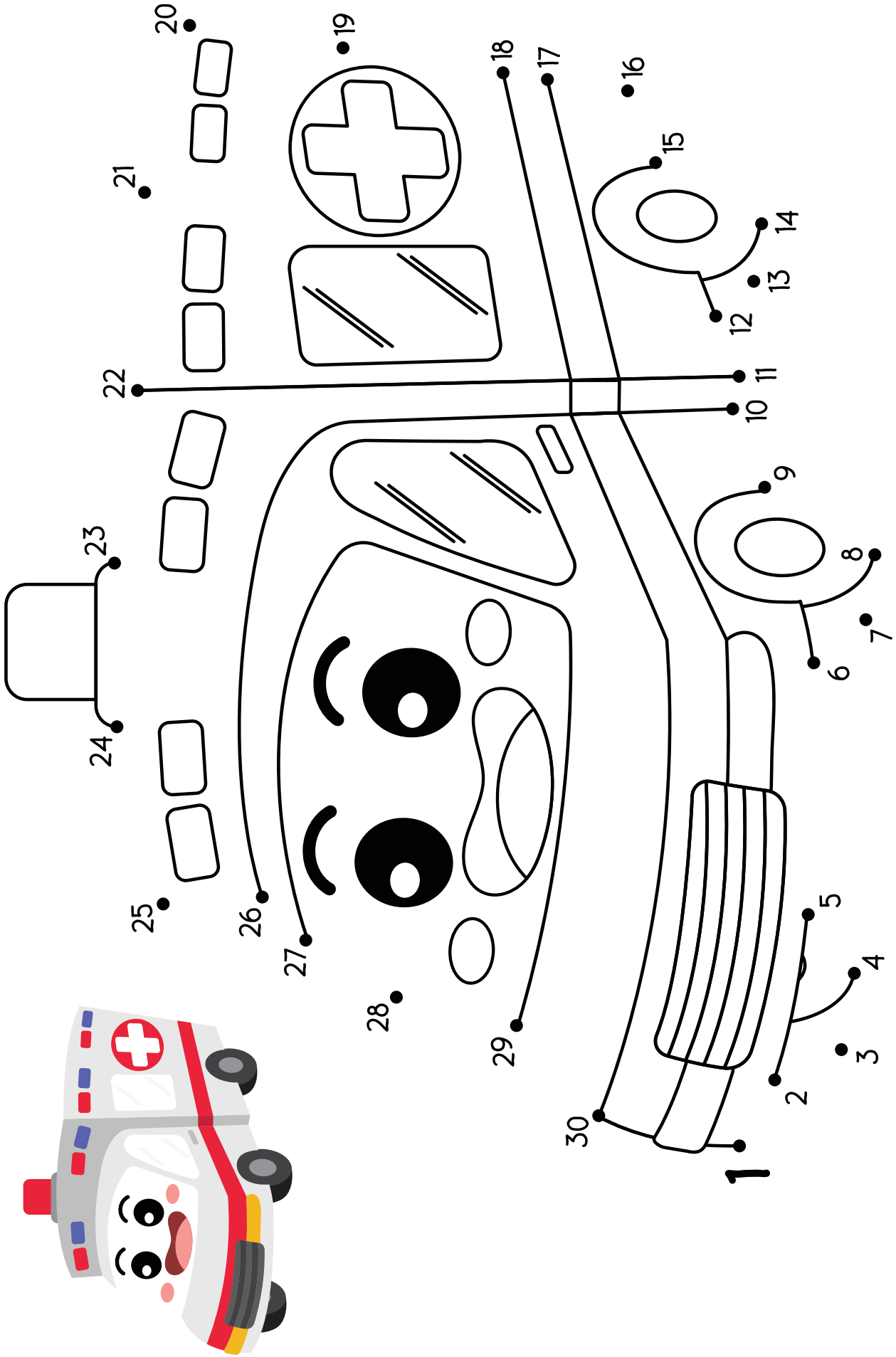

CONNECT THE DOTS

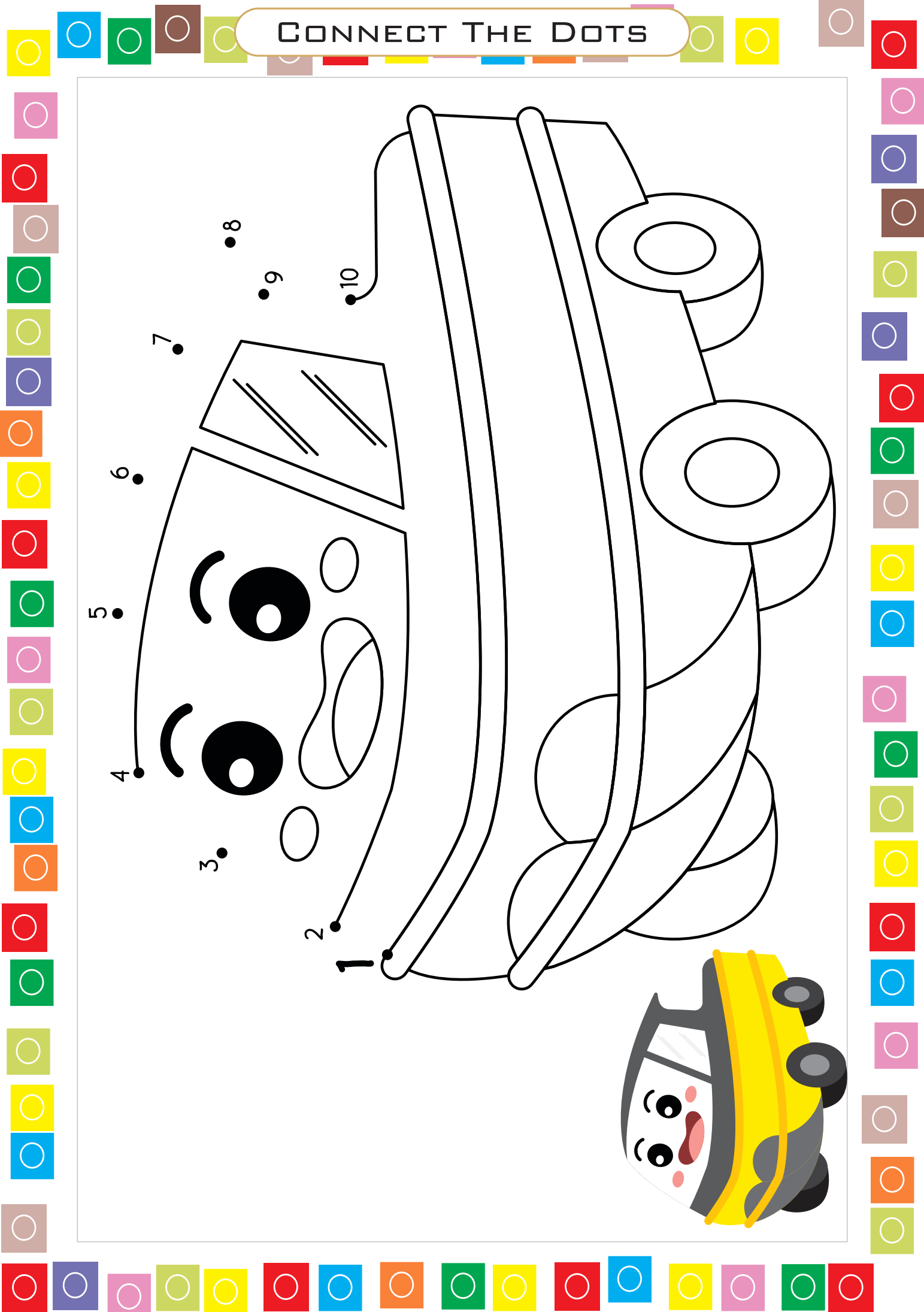
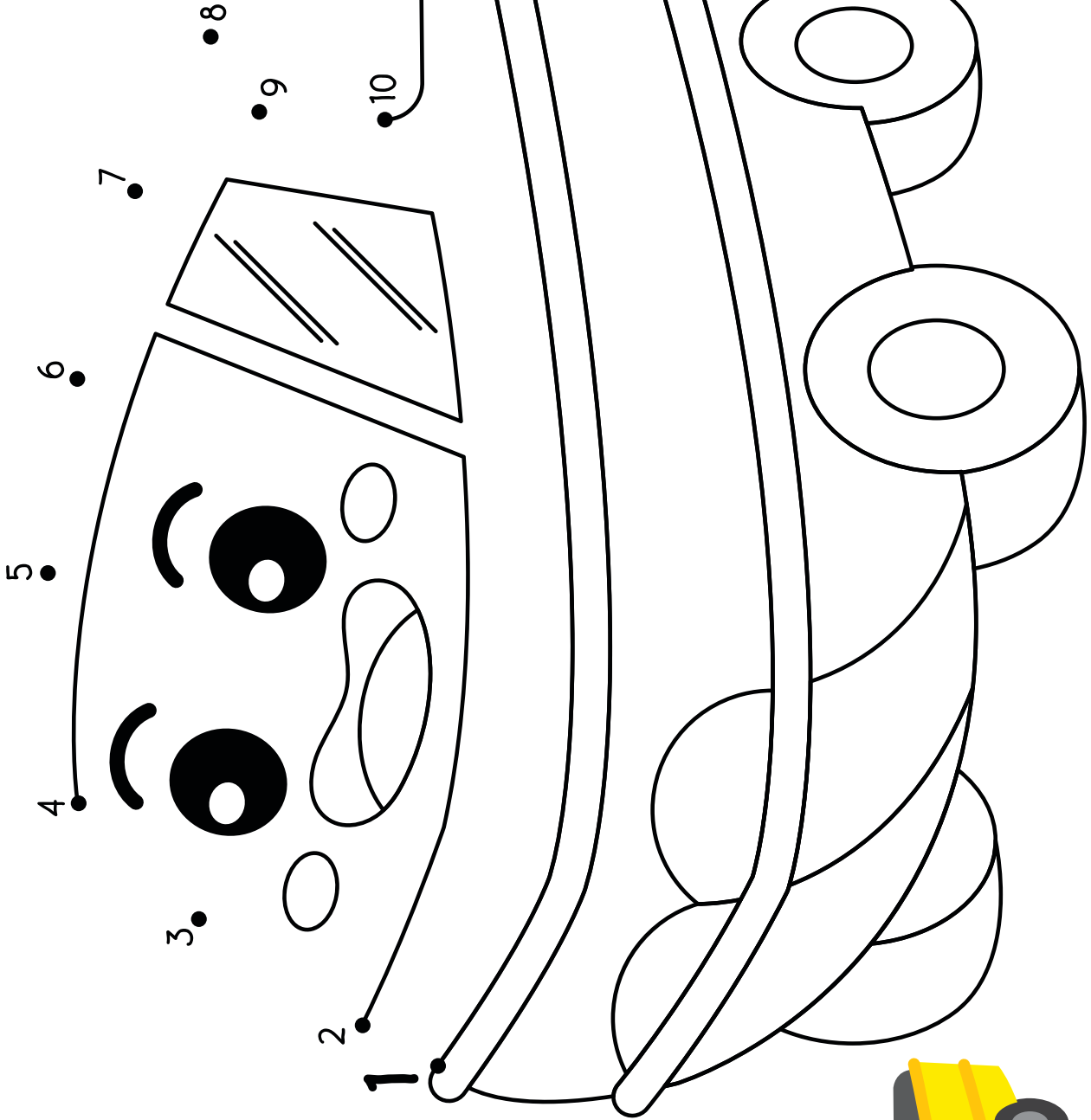

CONNECT THE DOTS

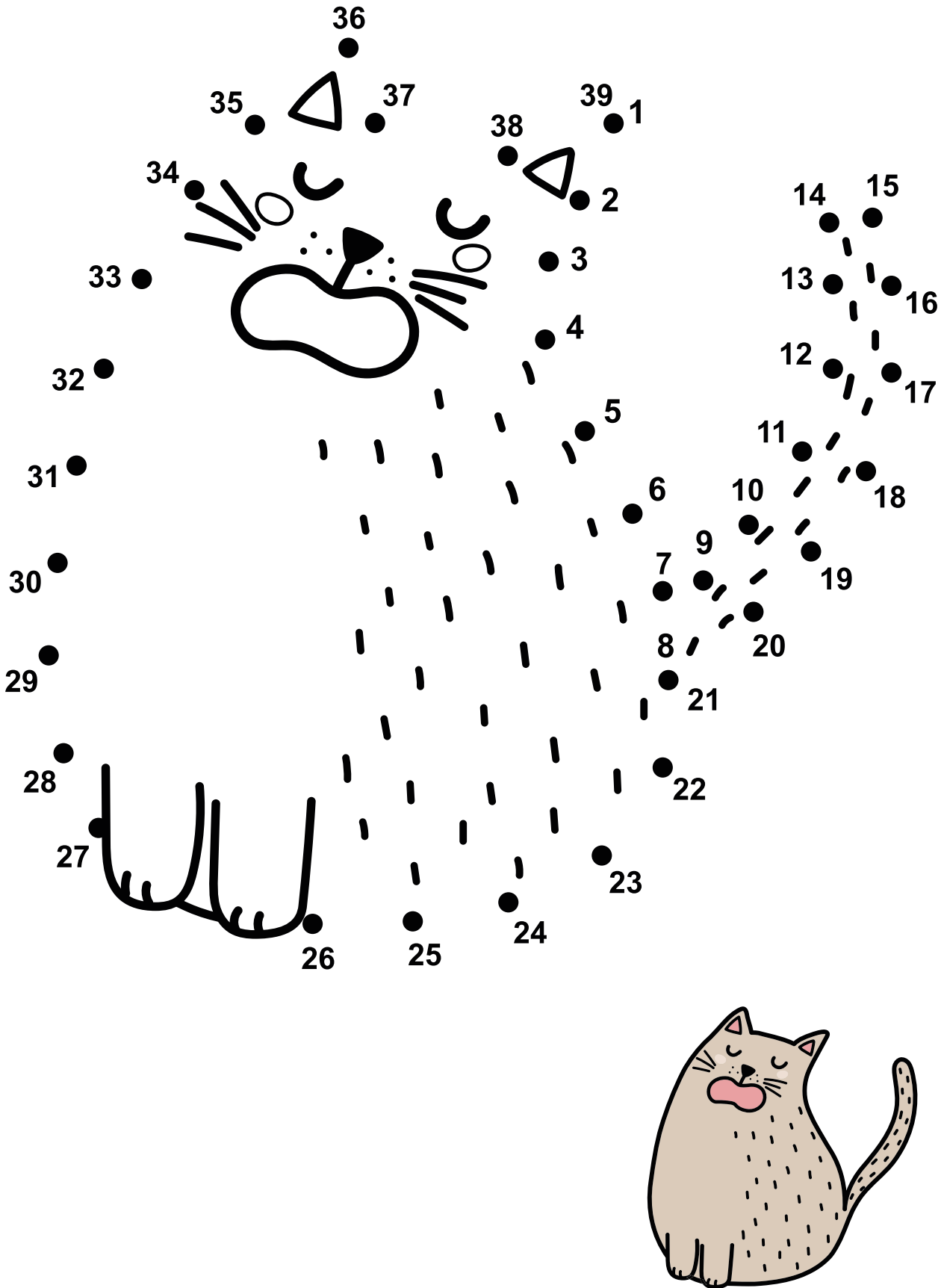

CONNECT THE DOTS

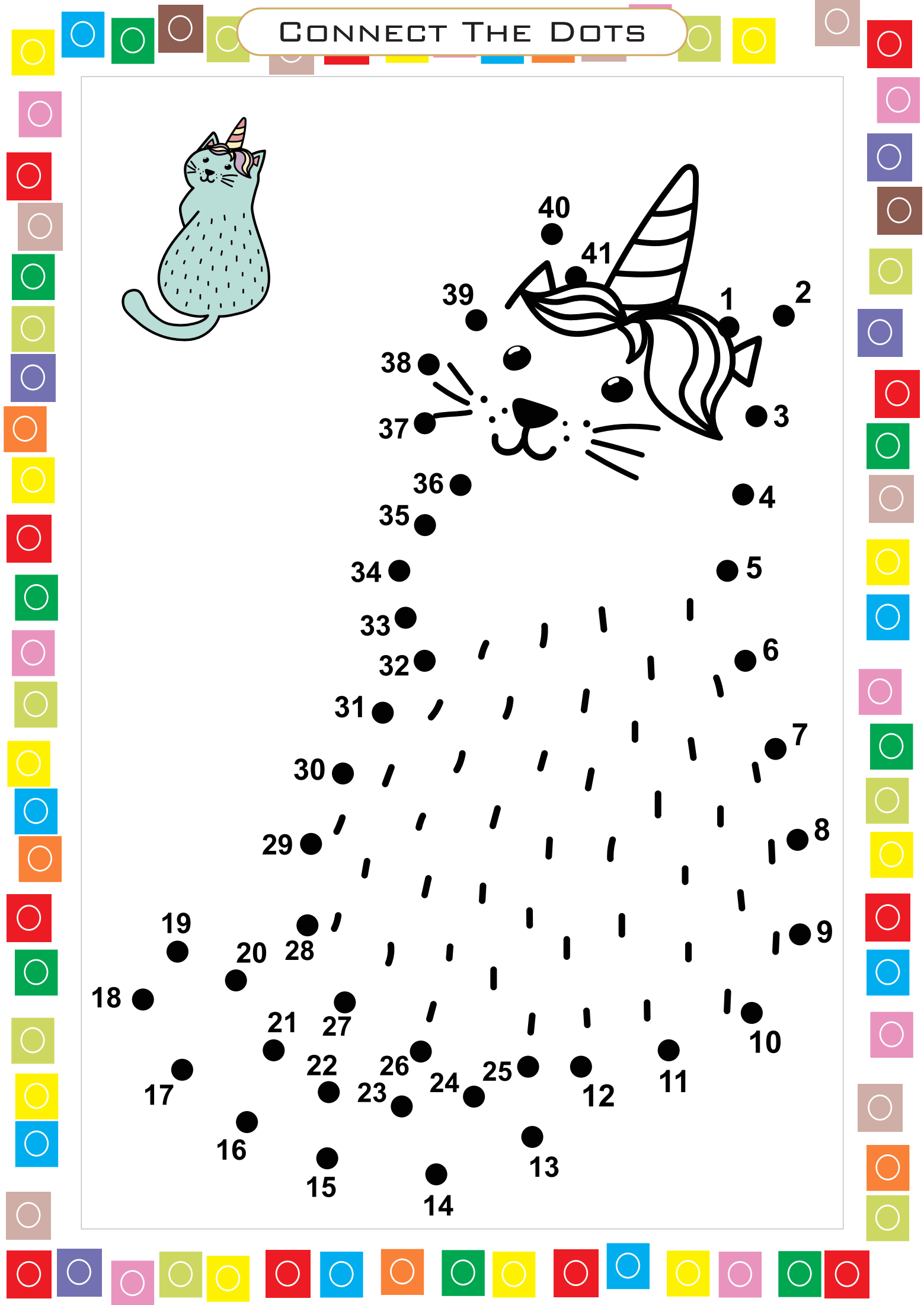
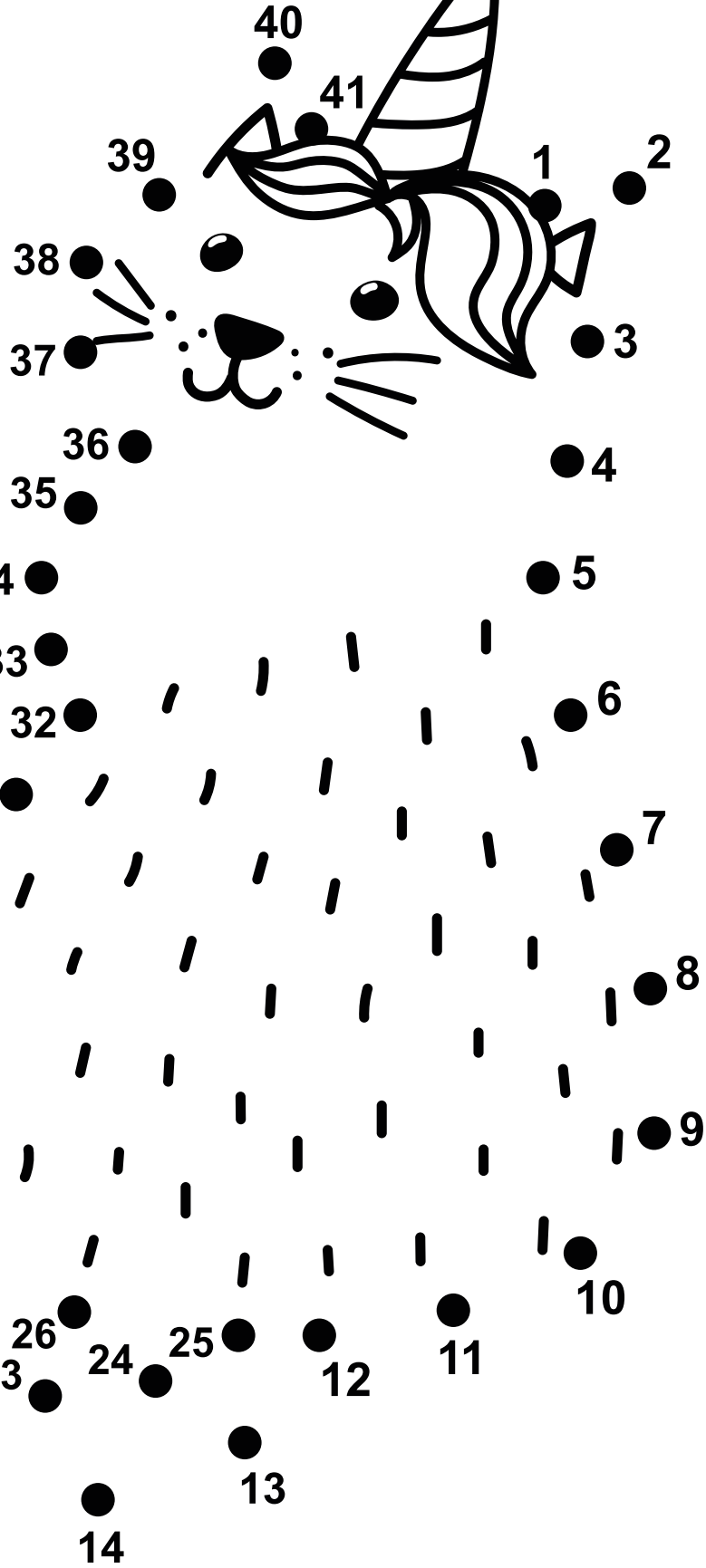
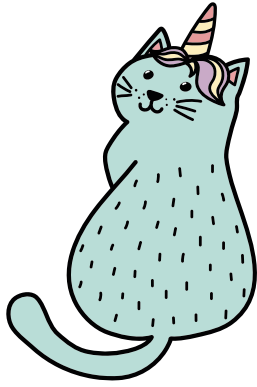

CONNECT THE DOTS

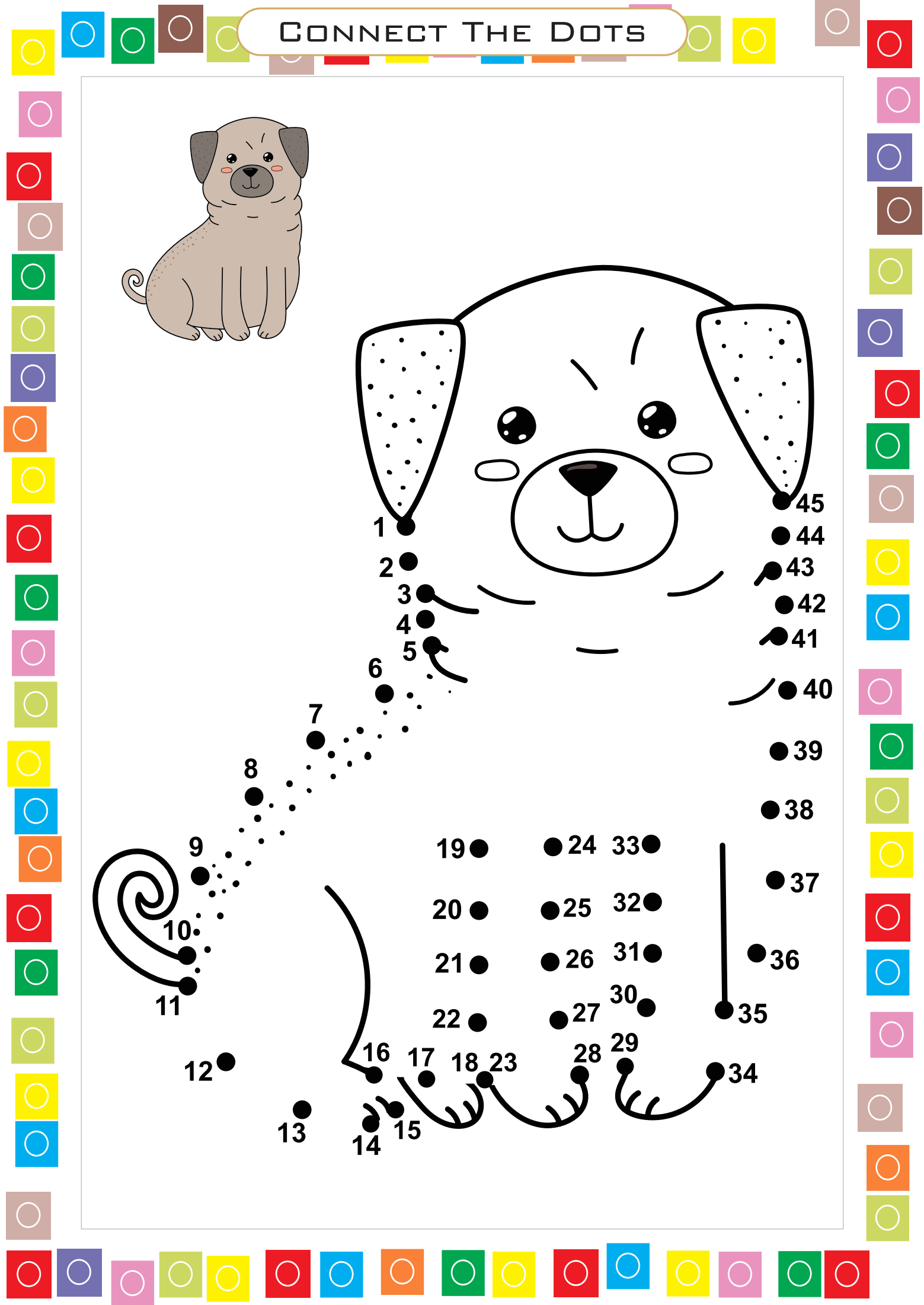
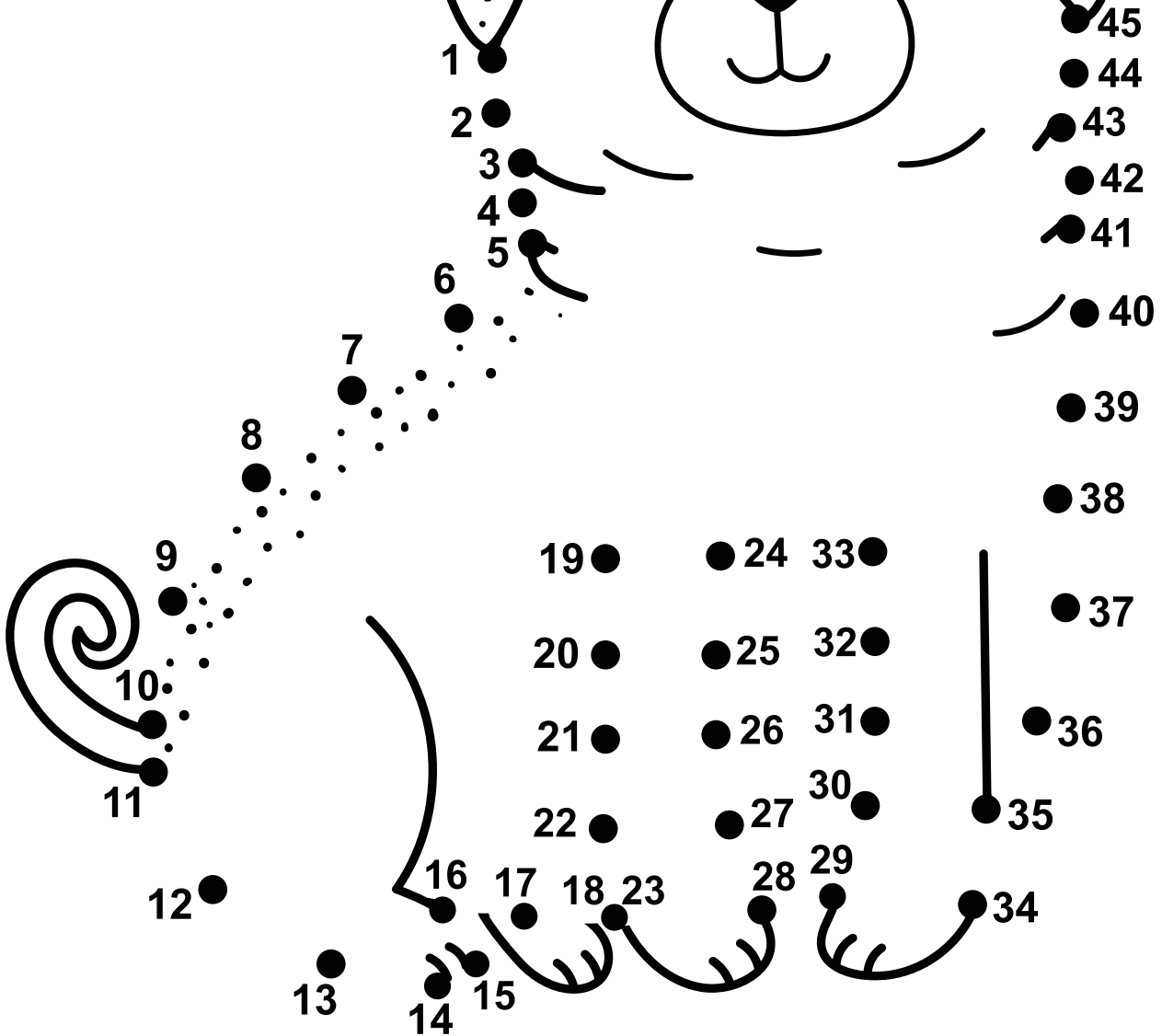
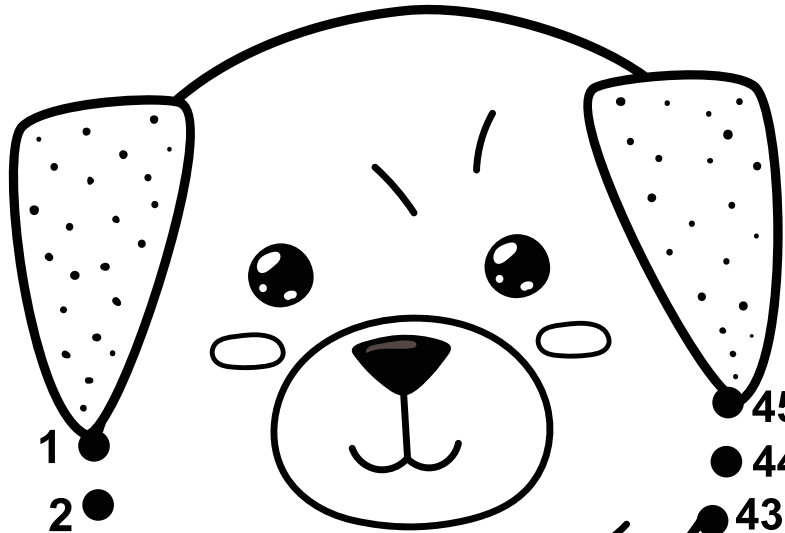
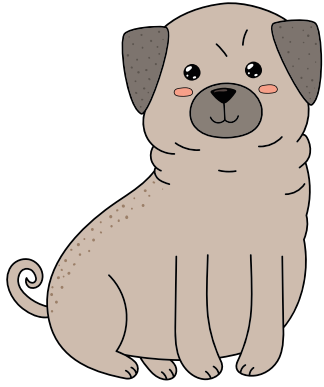

CONNECT THE DOTS

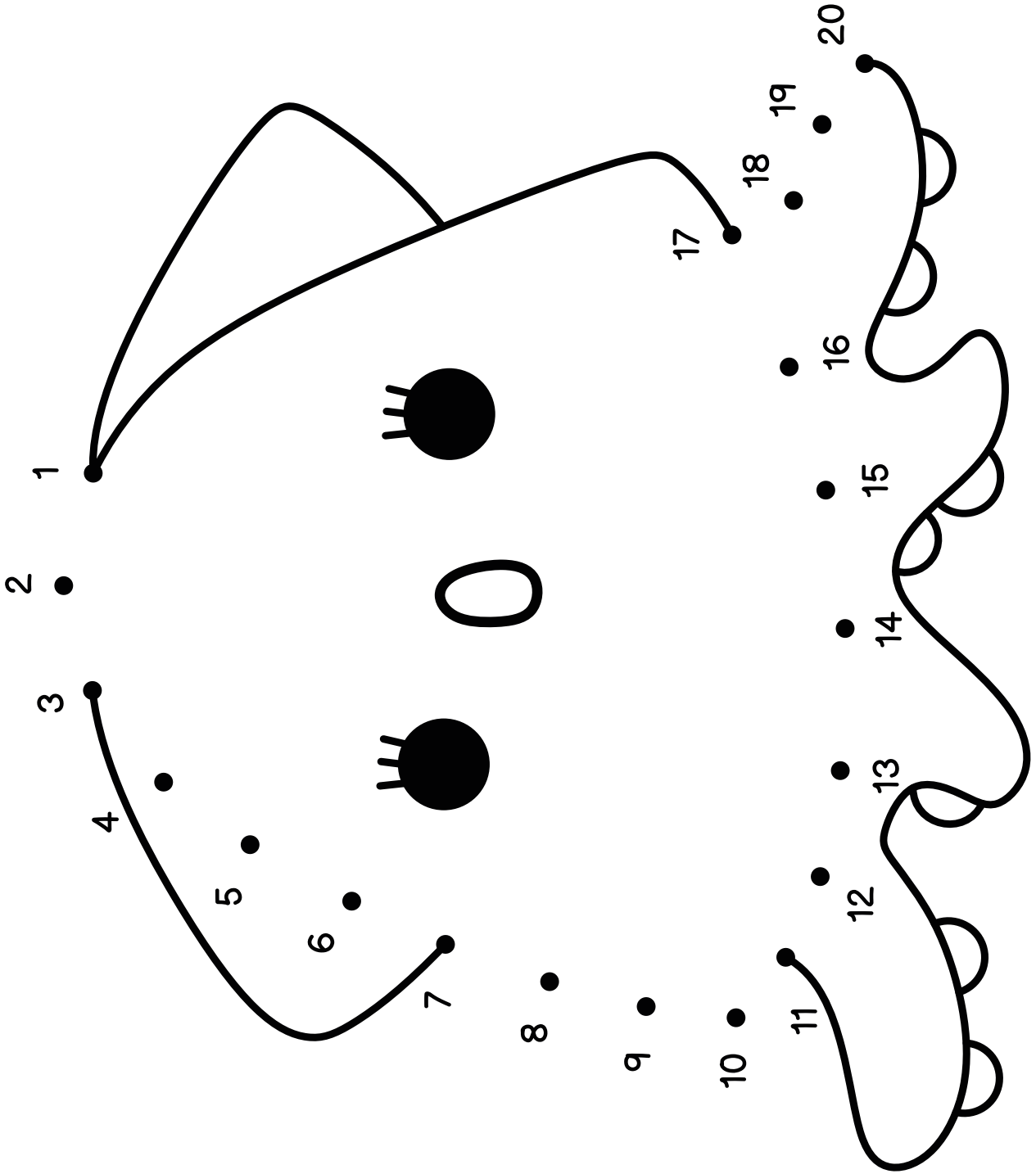
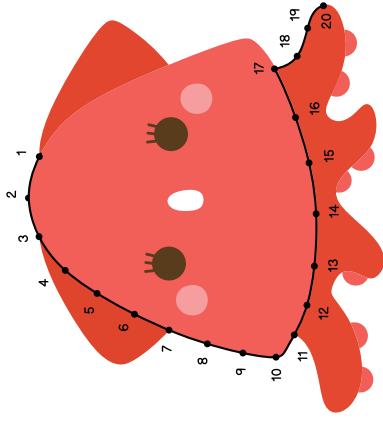

CONNECT THE DOTS

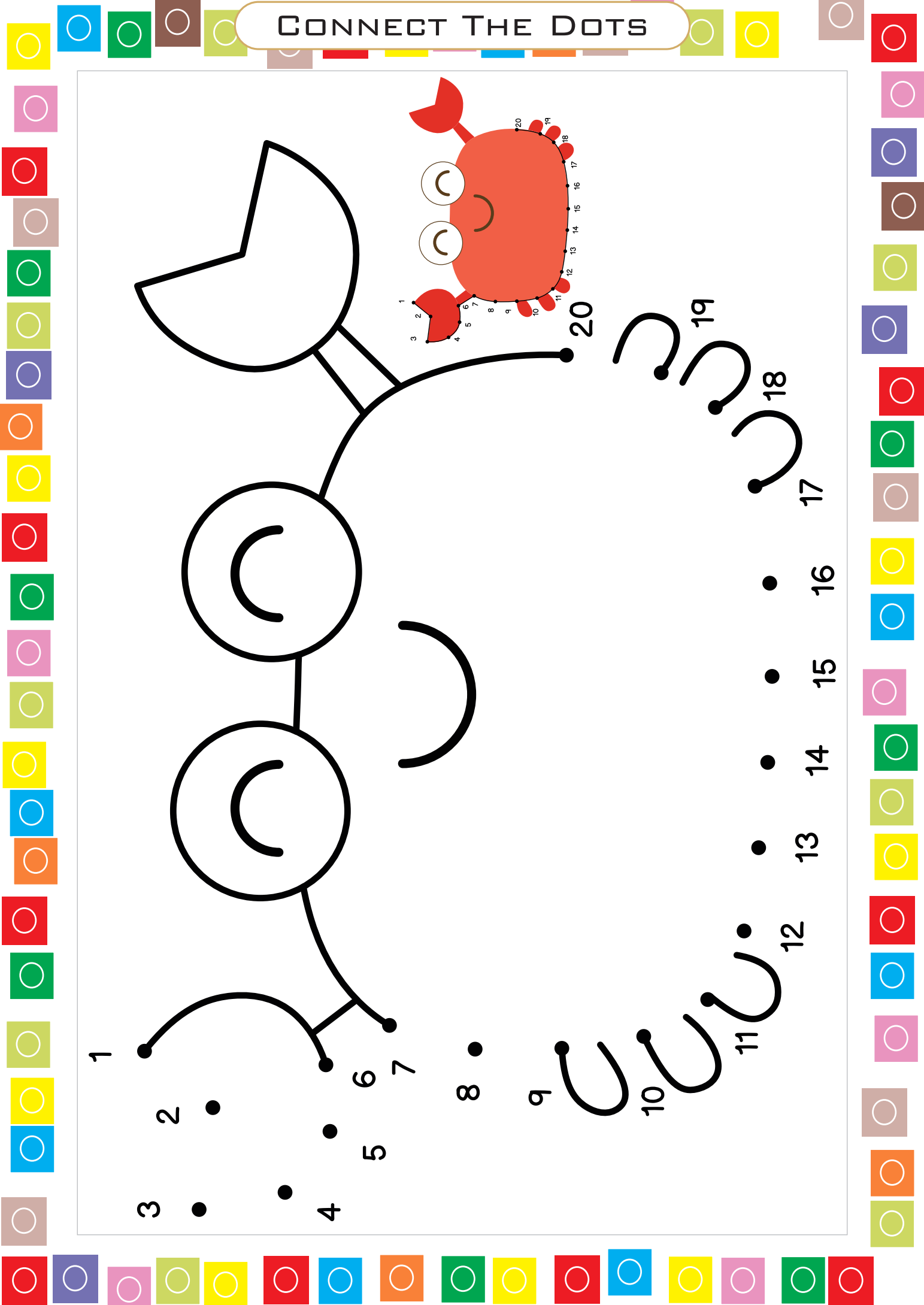
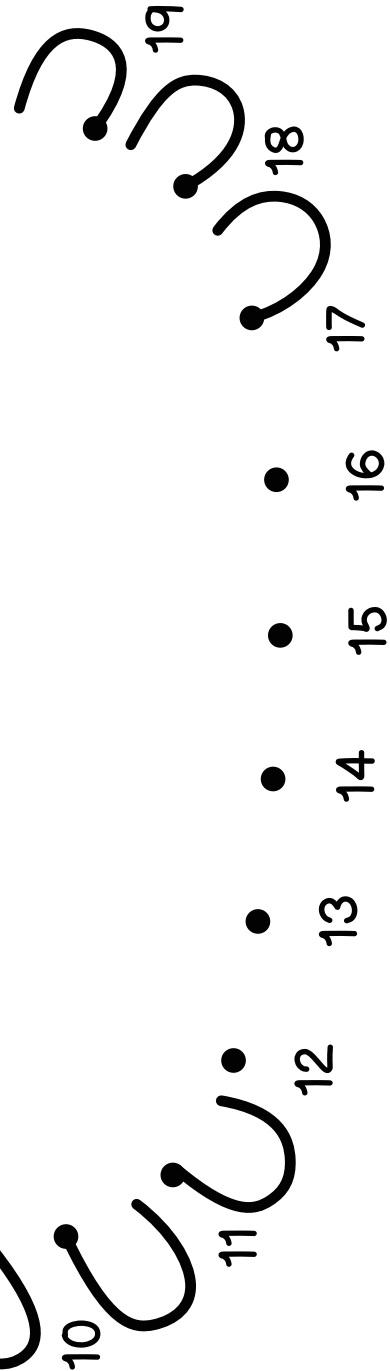
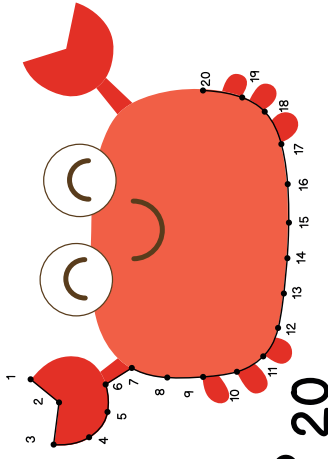
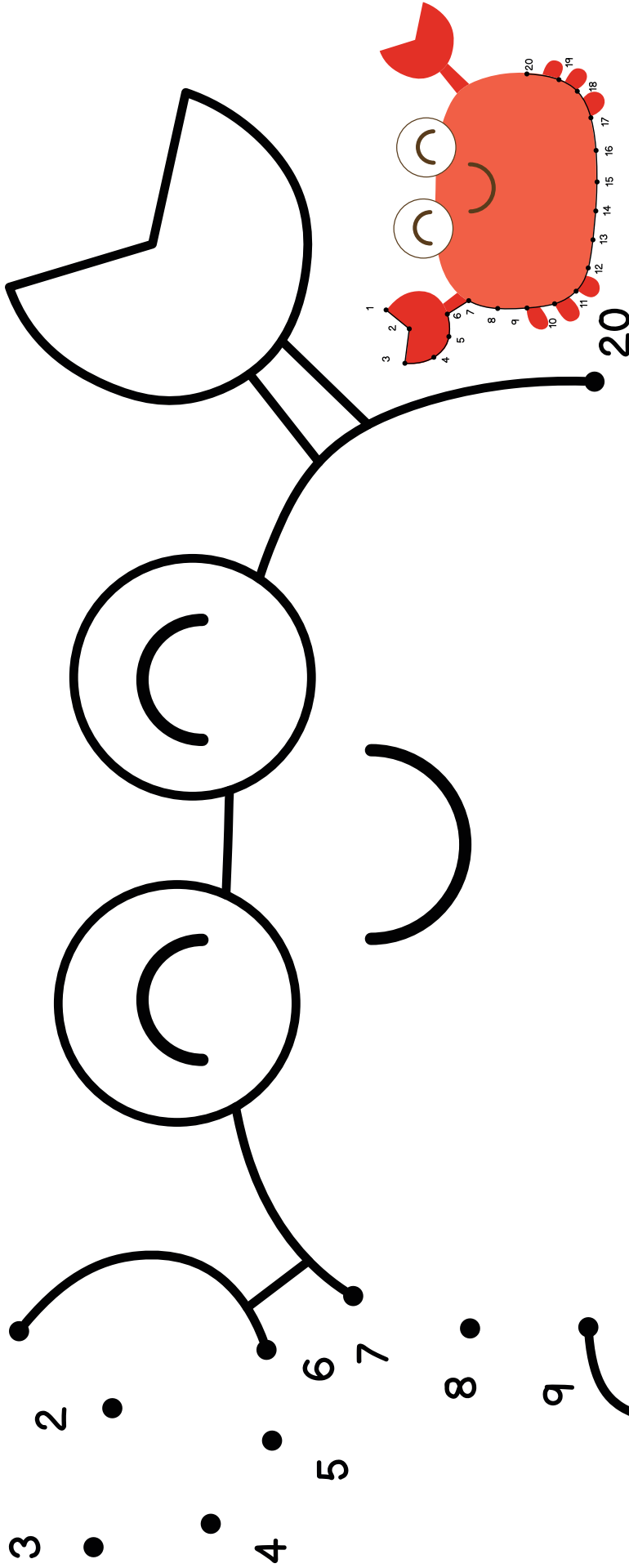

CONNECT THE DOTS

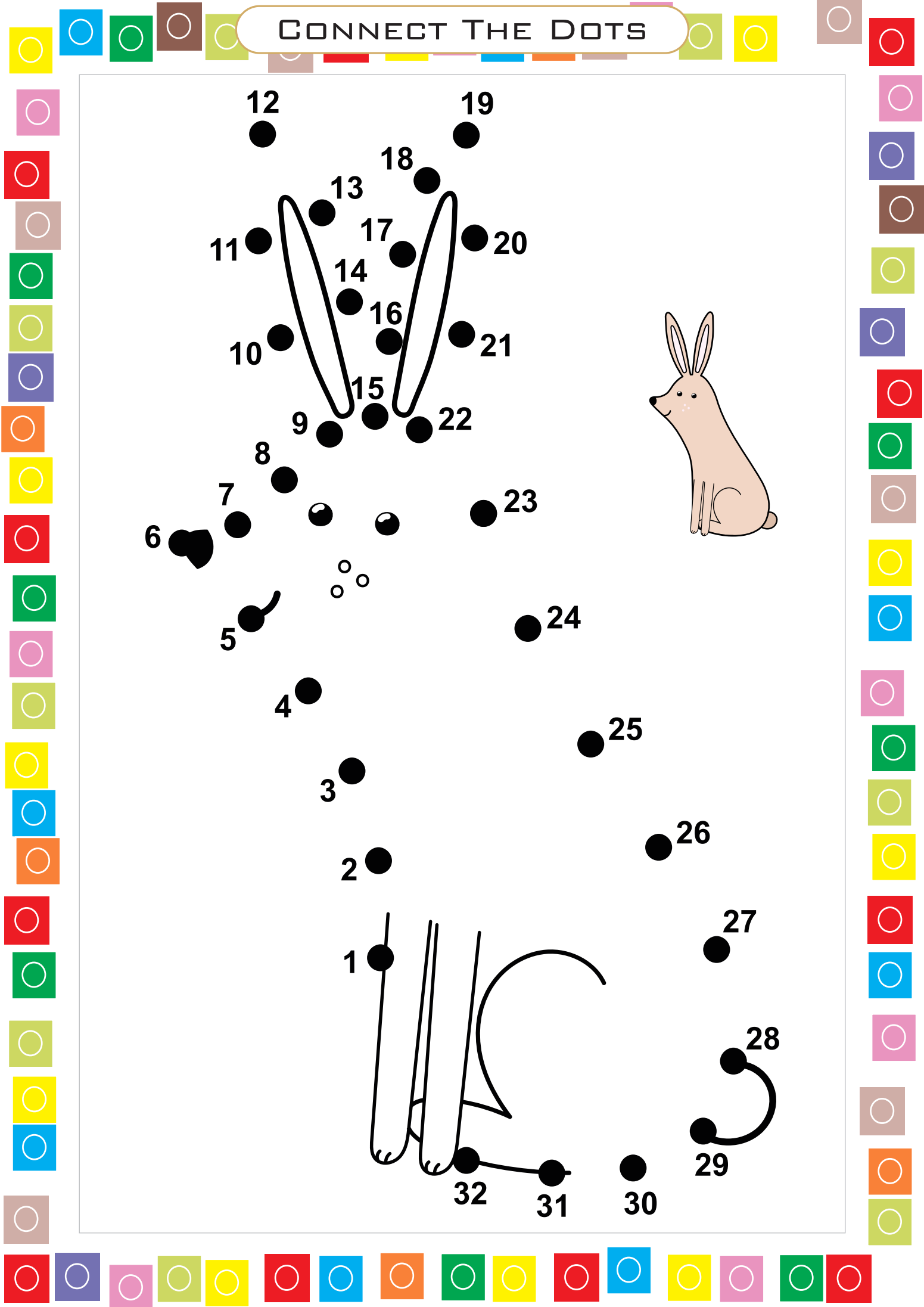
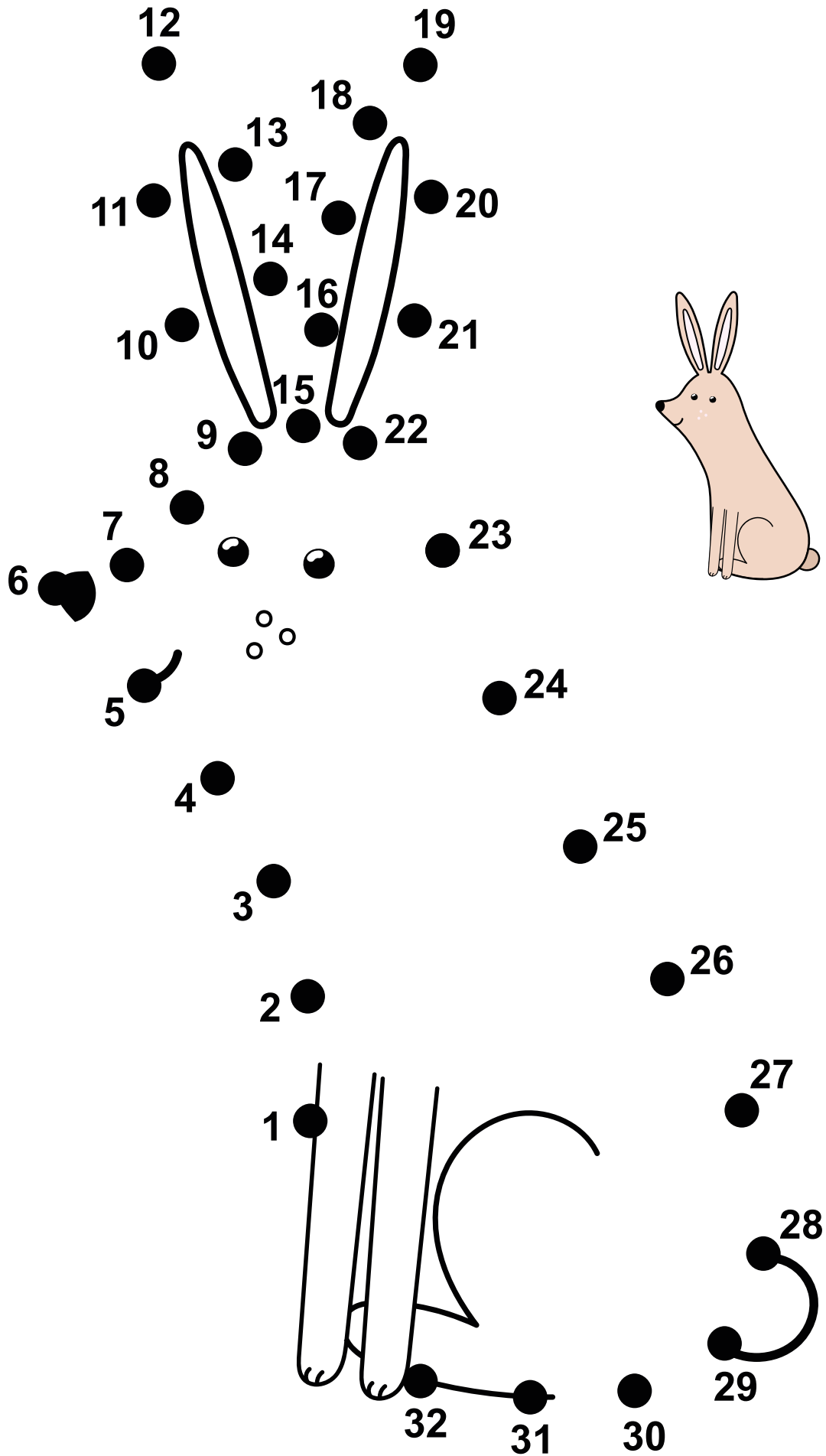

CONNECT THE DOTS

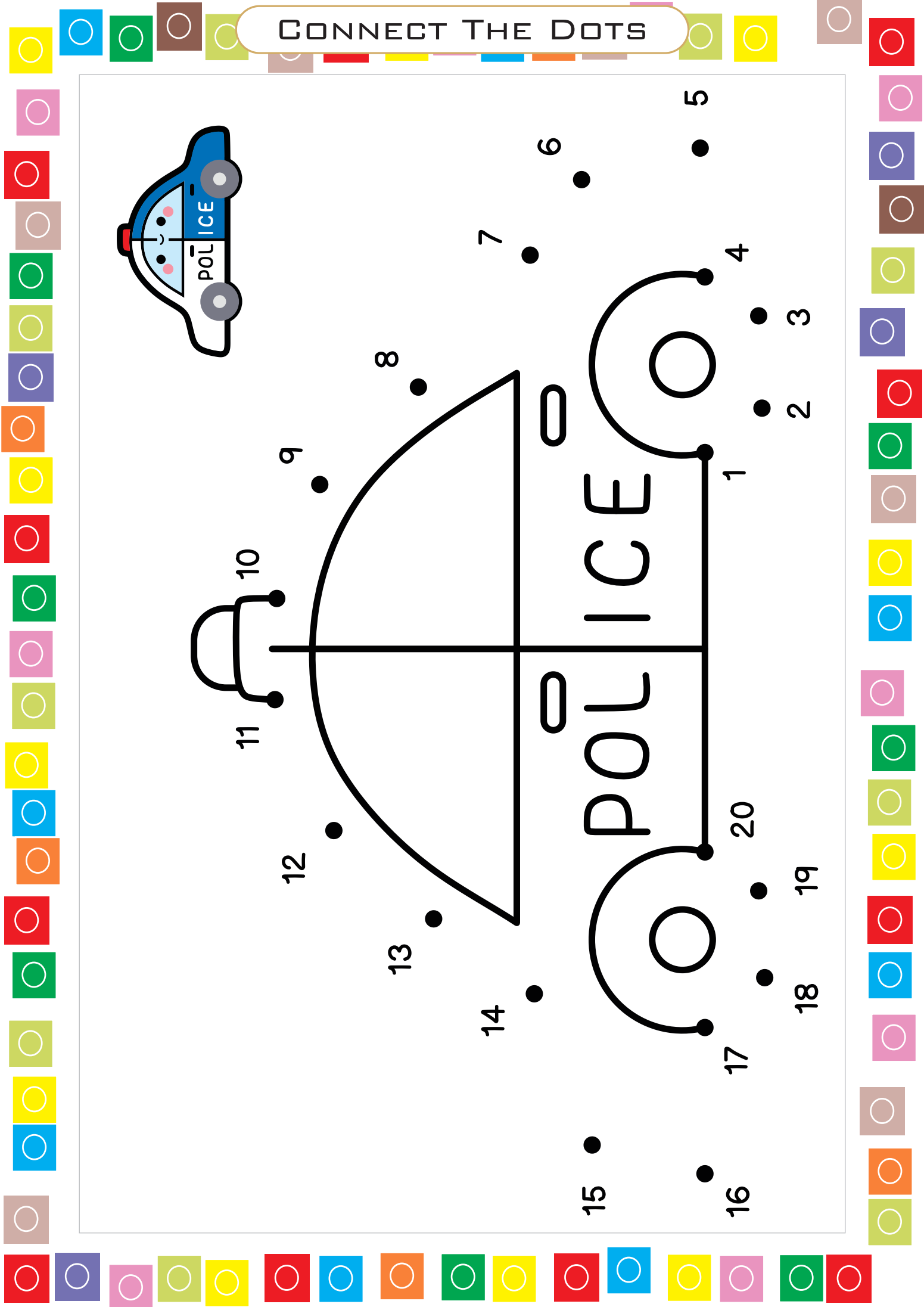
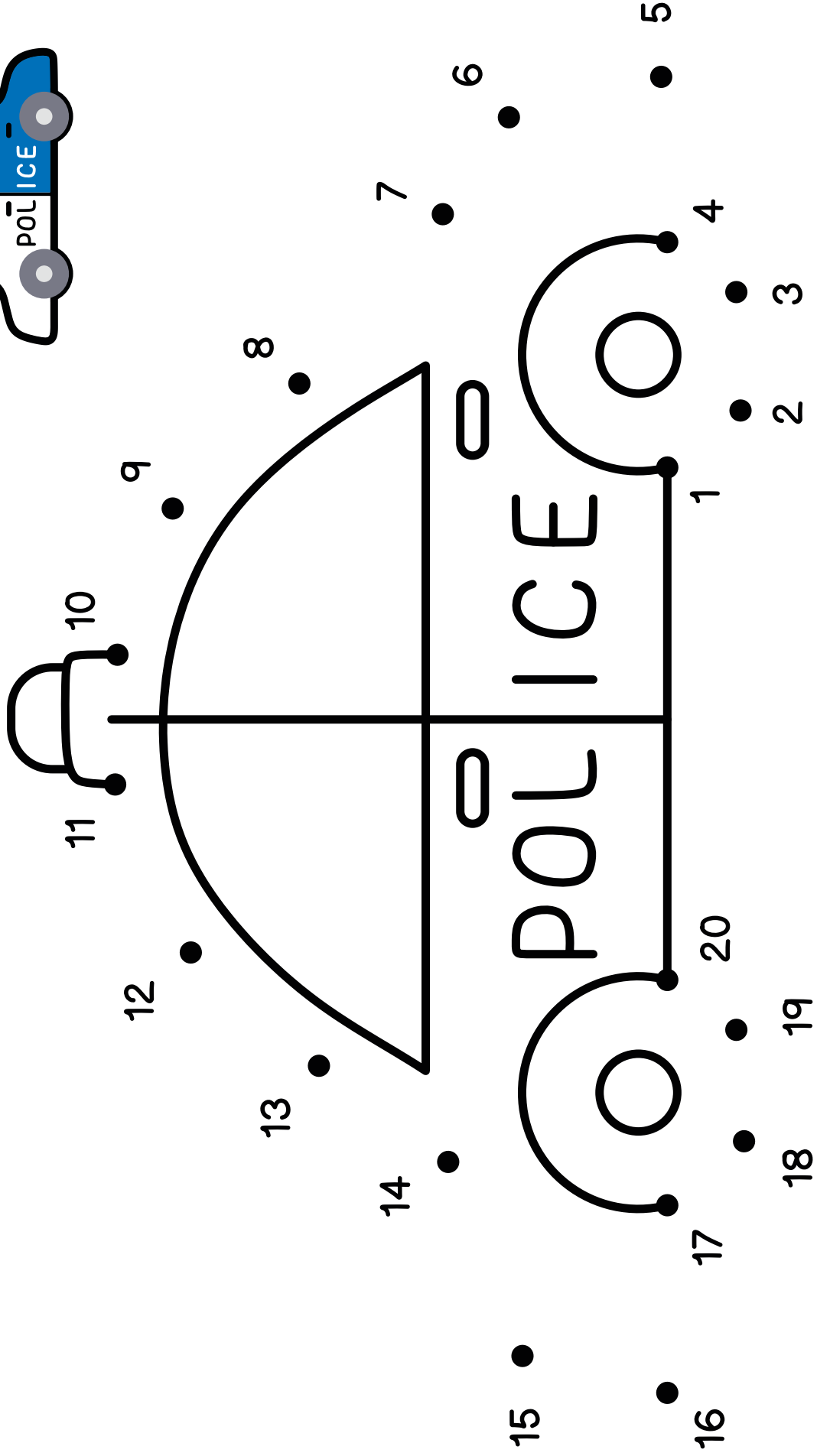
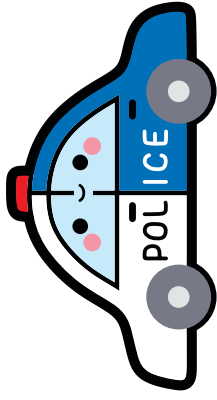

CONNECT THE DOTS



CONNECT THE DOTS

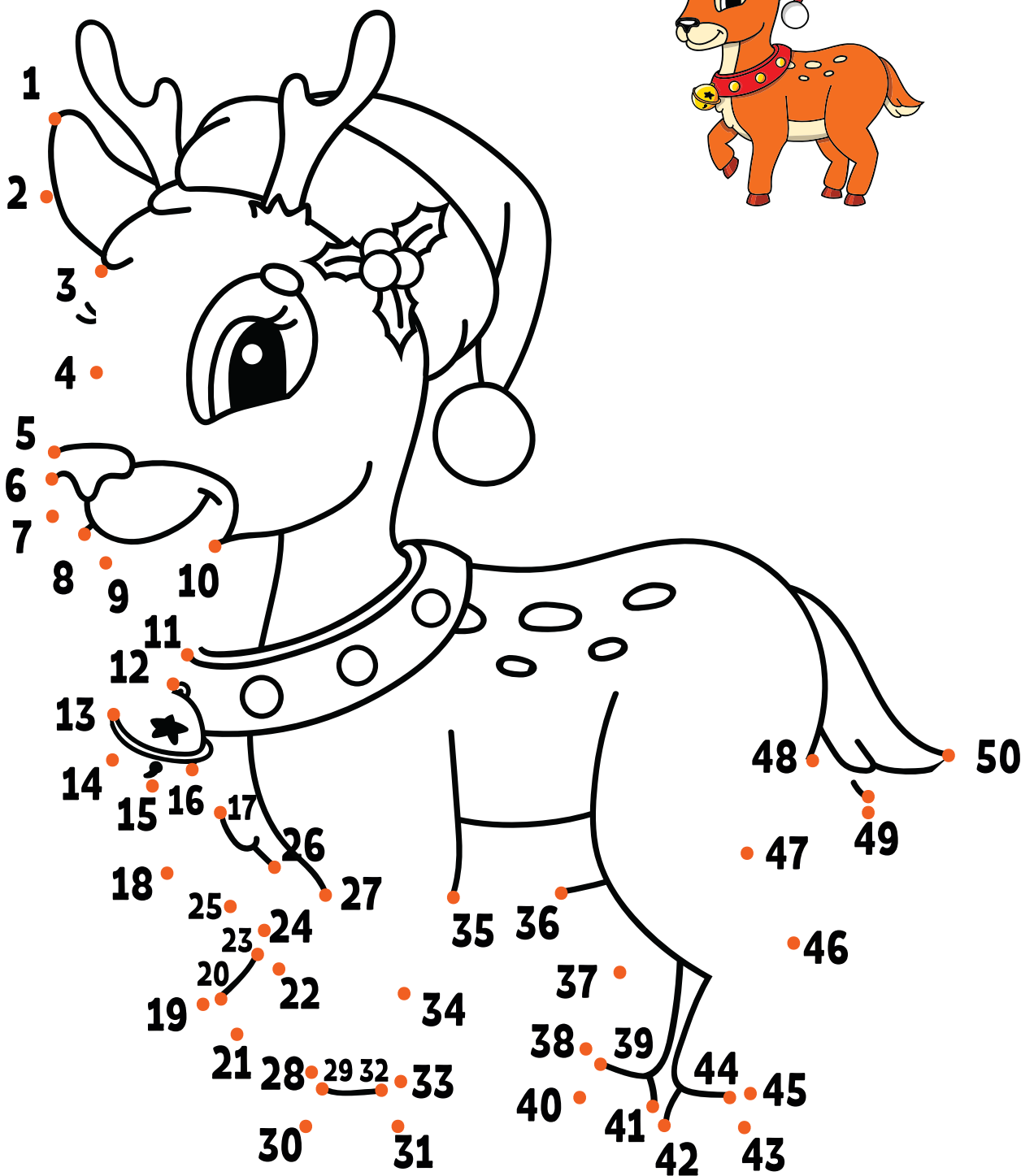

CONNECT THE DOTS



CONNECT THE DOTS

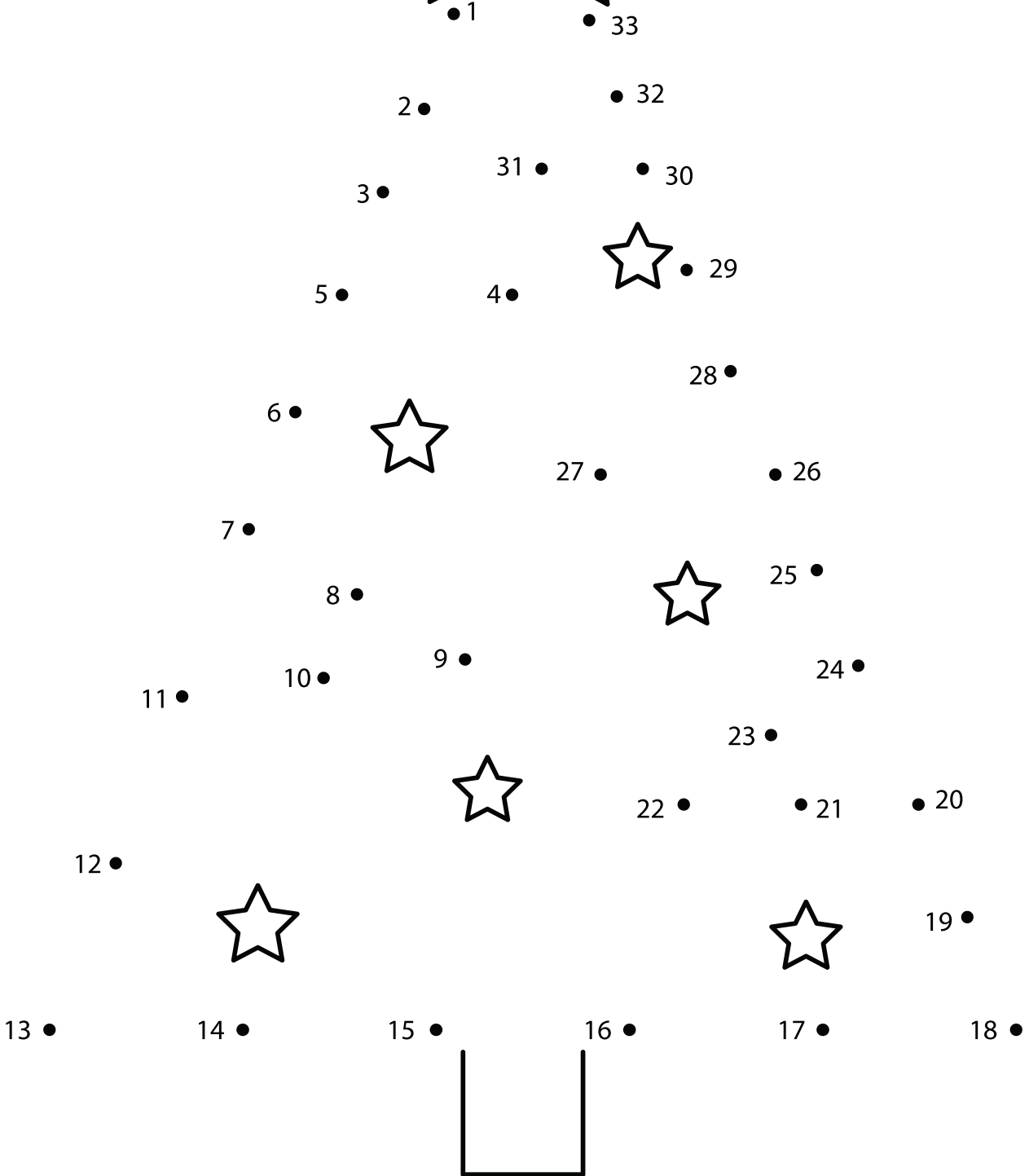
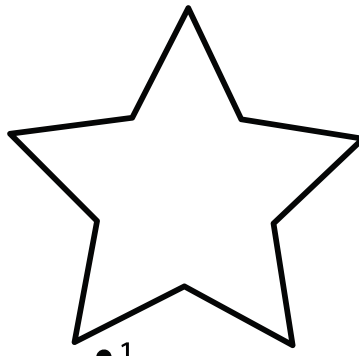

CONNECT THE DOTS

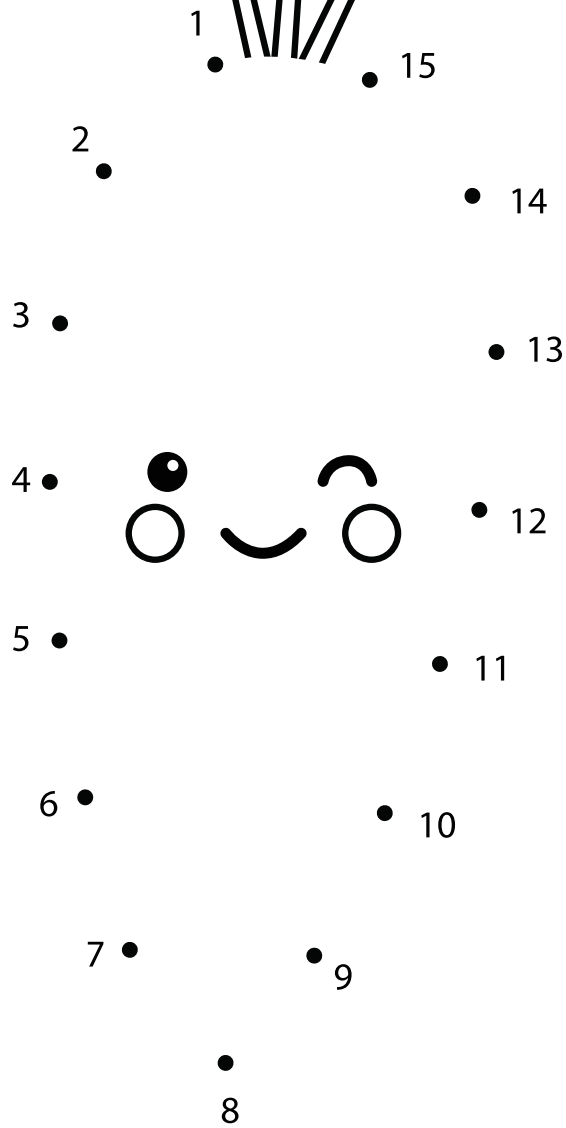
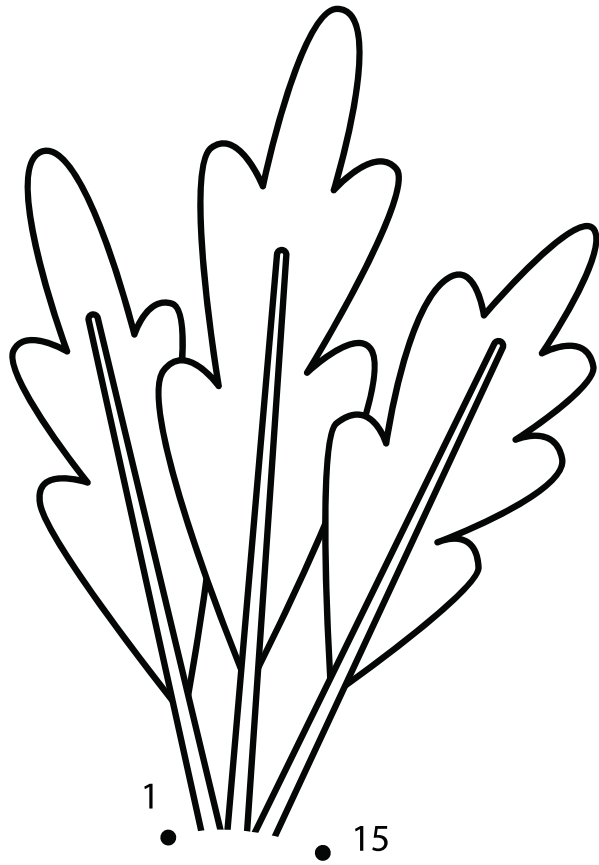

CONNECT THE DOTS

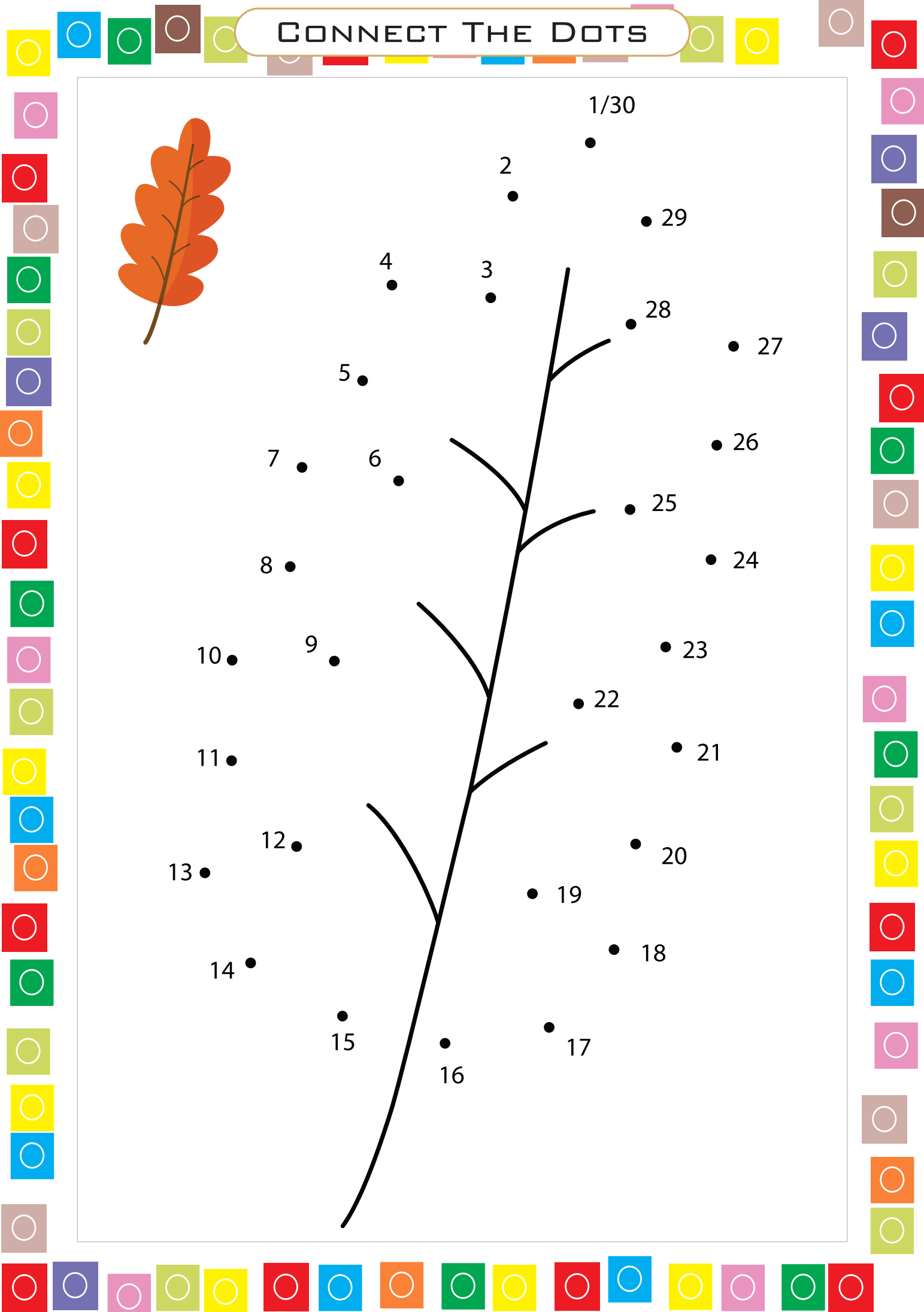
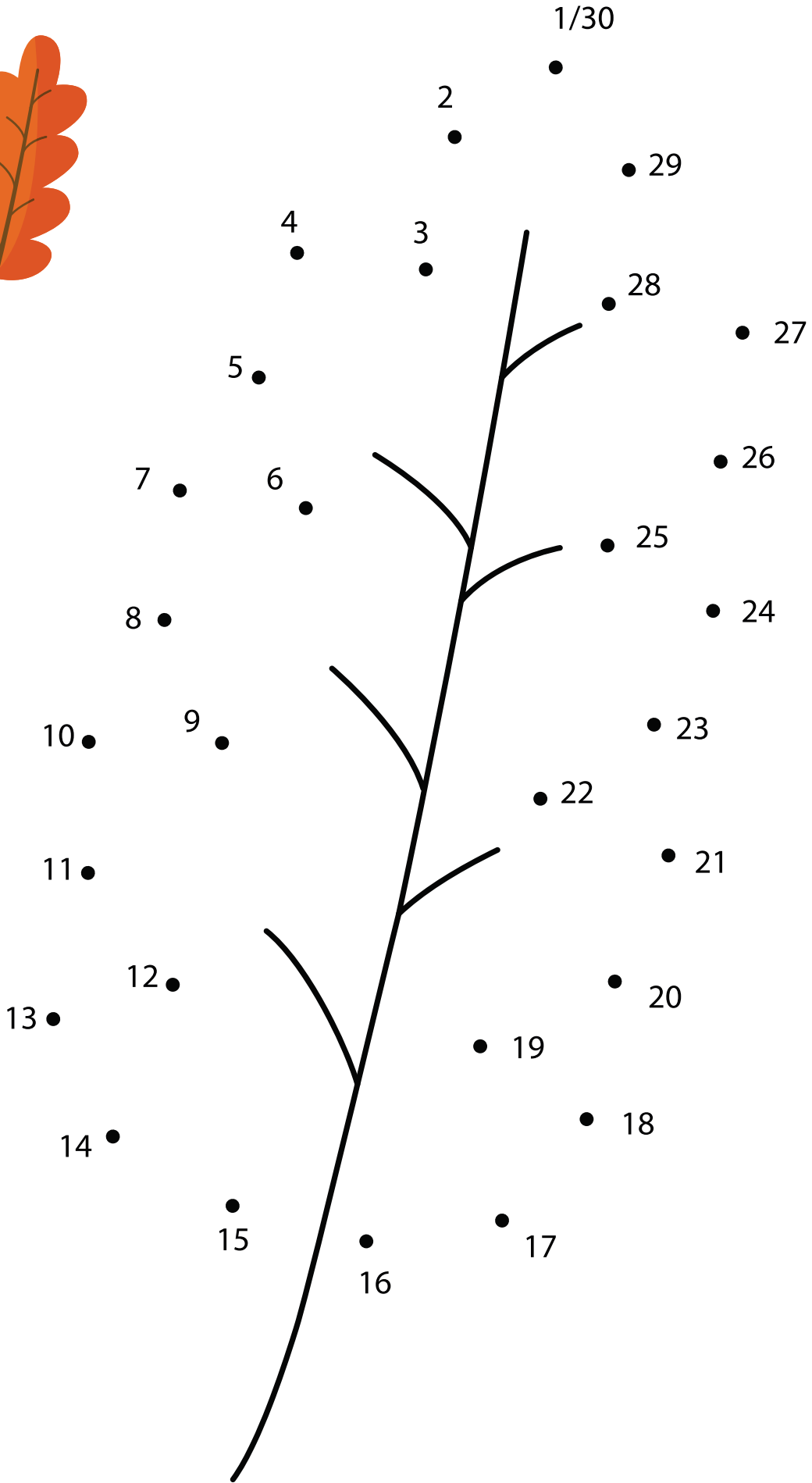

CONNECT THE DOTS

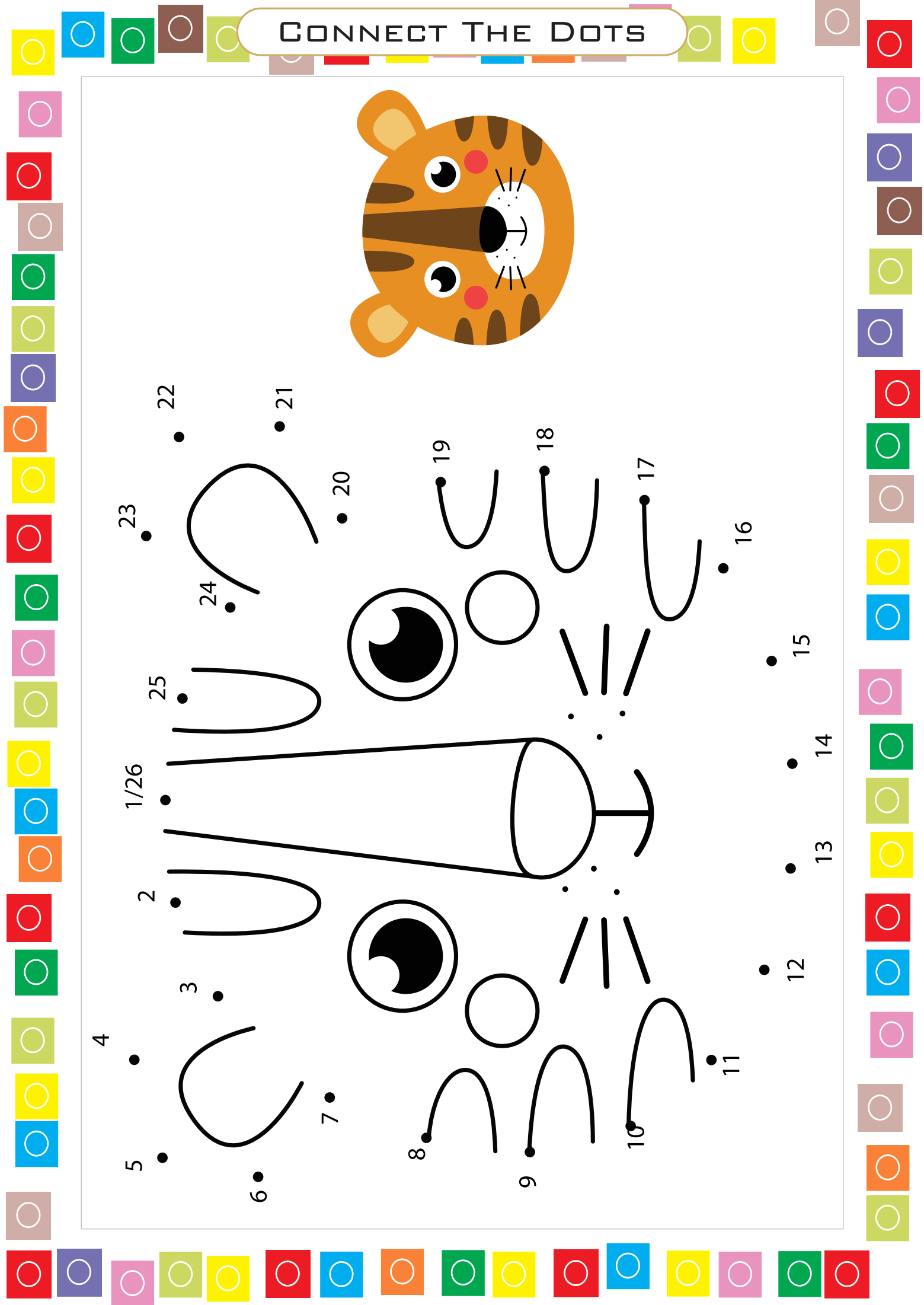
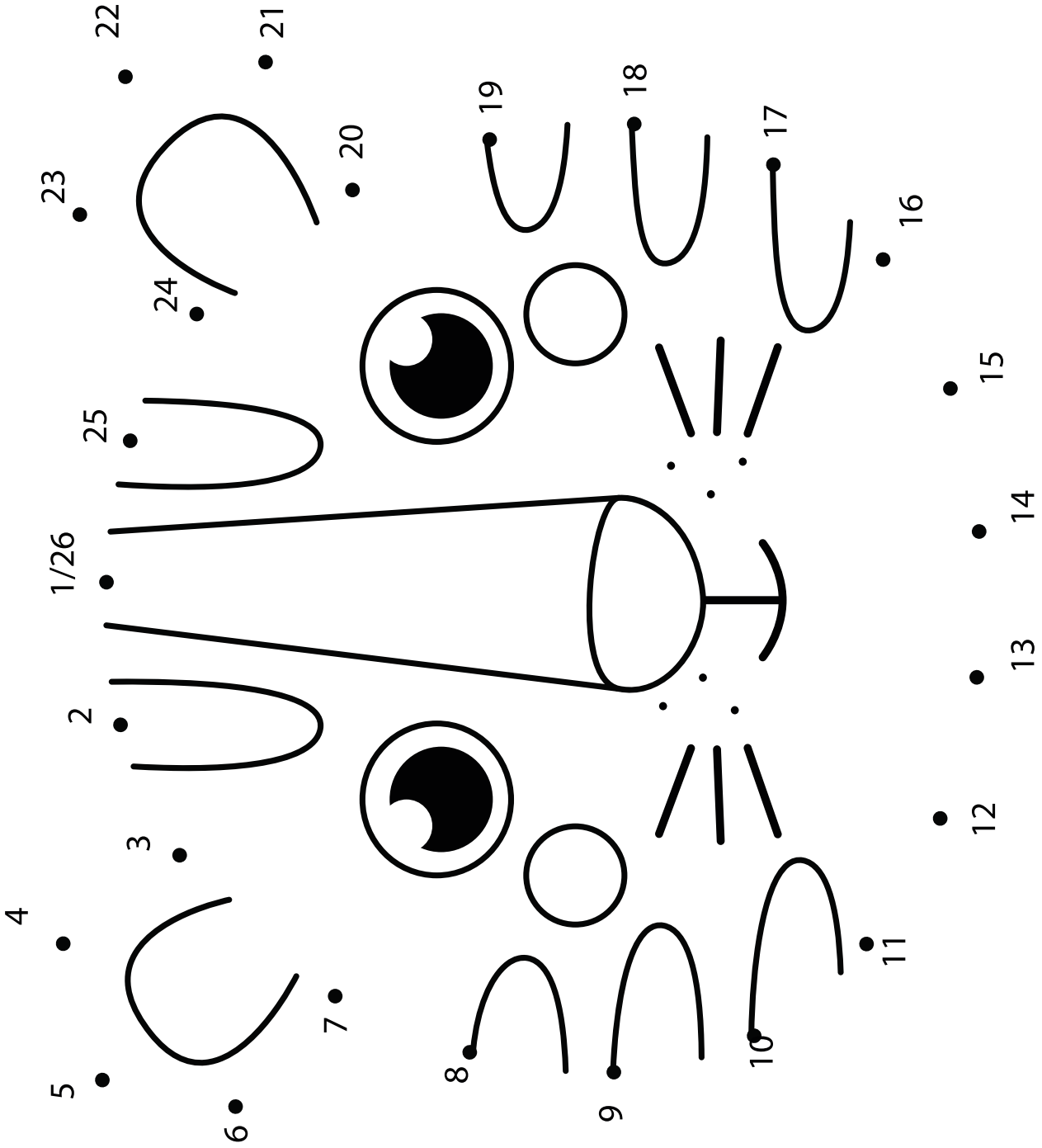

CONNECT THE DOTS

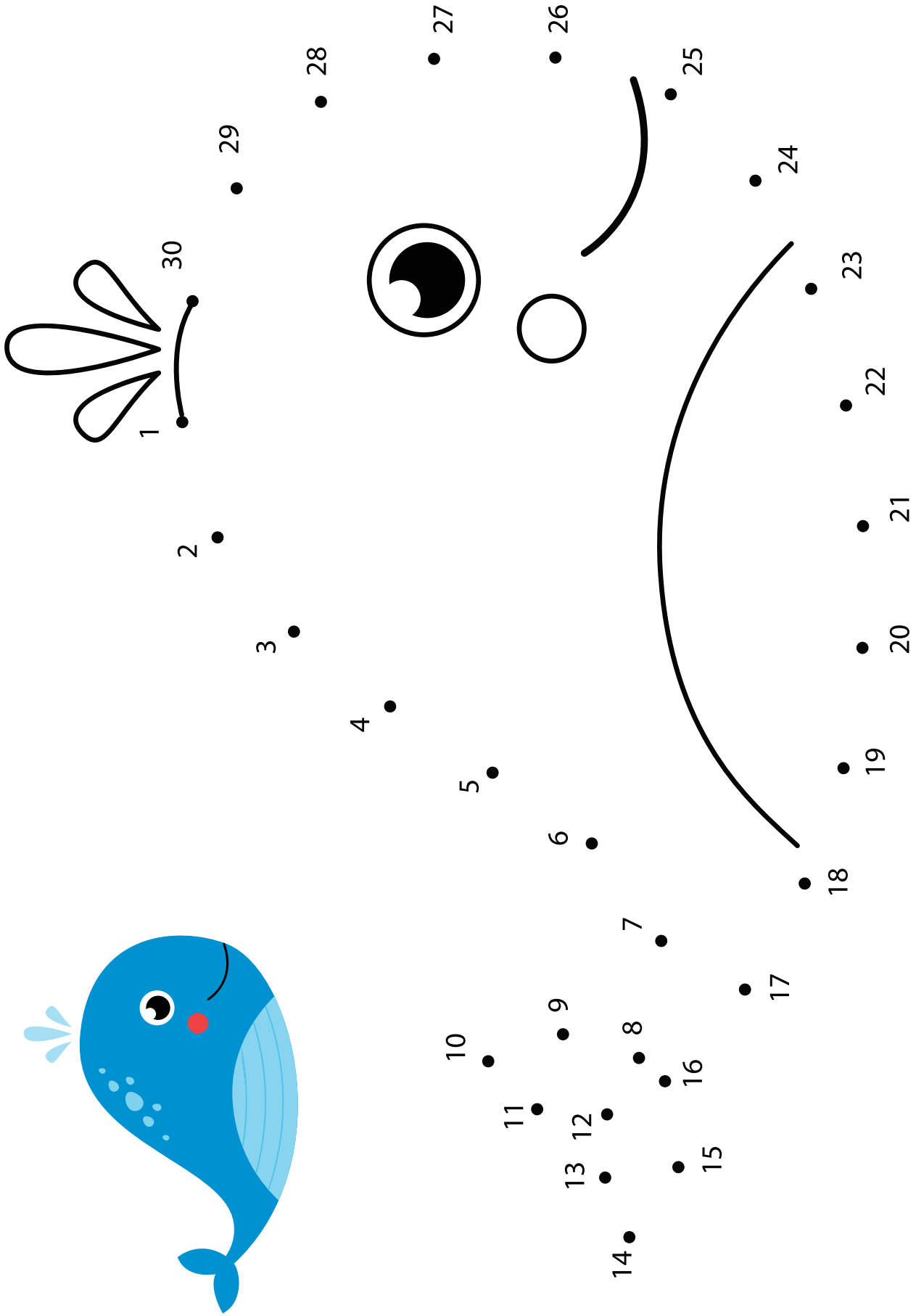

CONNECT THE DOTS



CONNECT THE DOTS

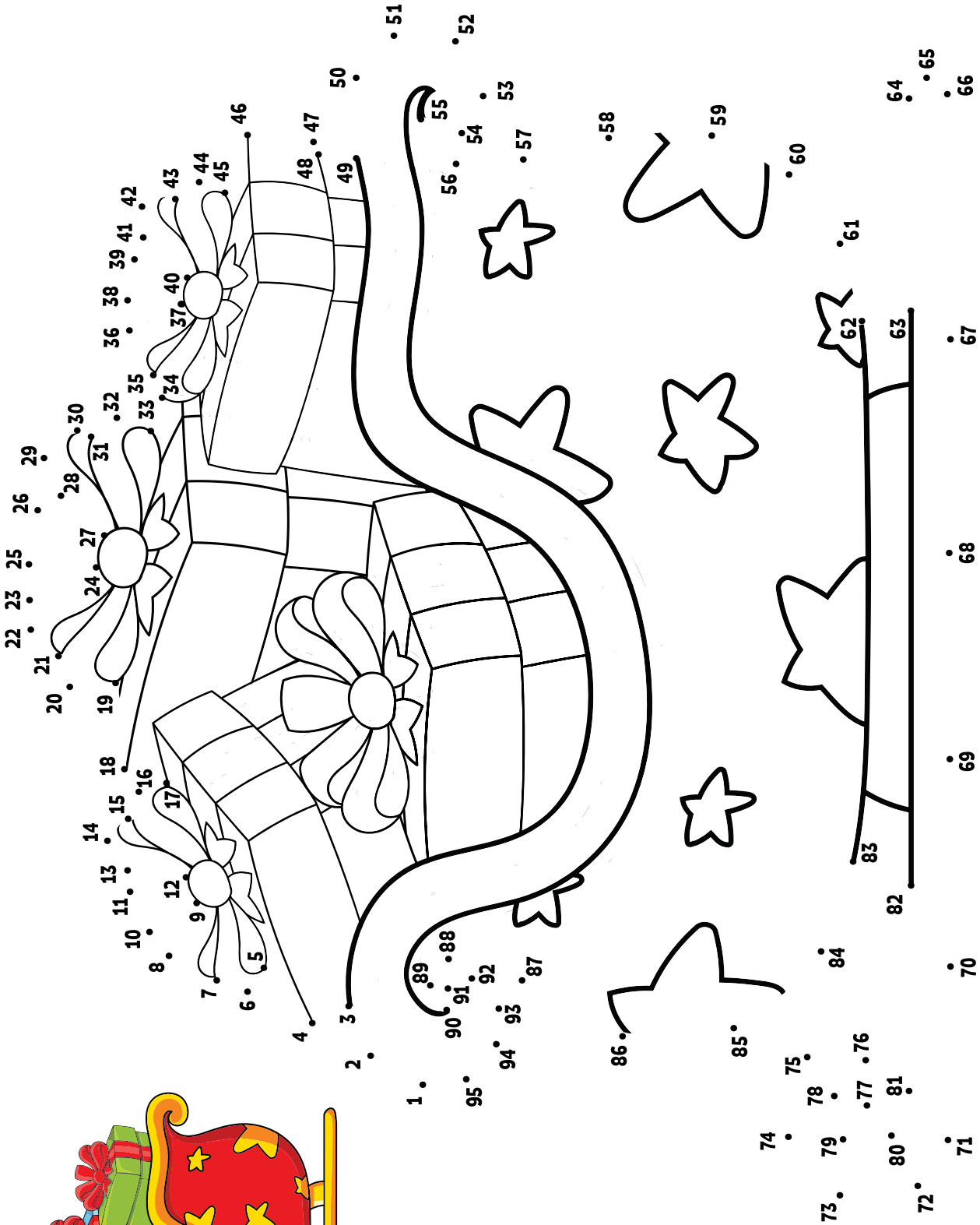
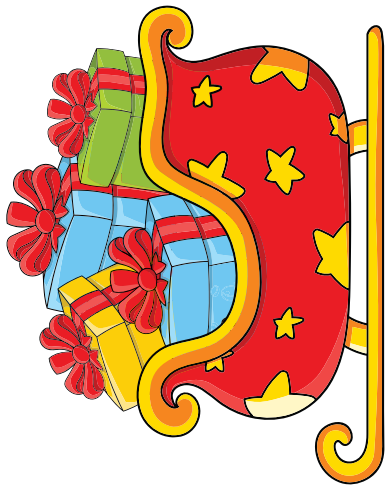

22 23 25 26 29
20 21 24 27 28 30
14 13 15 18 19 31 32 36 38 39 41 42
10 11 12 16 17 33 34 37 40 43
8 9 7 6 5 4 44 45 46
2 3 48 47 49 50

1 2 3 4 5 6 7 8 9 10 11 12 13 14 15 16 17 18 19 20 21 22 23 24 25 26 27 28 29 30 31 32 33 34 35 36 37 38 39 40 41 42 43 44 45 46 47 48 49 50 51 52 53 54 55 56 57 58 59 60 61 62 63 64 65 66 67 68 69 70 71 72 73 74 75 76 77 78 79 80 81 82 83 84 85 86 87 88 89 90 91 92 93 94 95

86 85 74 73 79 80 72 81 82 83 61 62 63 64 65 66 67 68 69 70 71 72 73 74 75 76 77 78 79 80 81 82 83 84 85 86 87 88 89 90 91 92 93 94 95

CONNECT THE DOTS



CONNECT THE DOTS

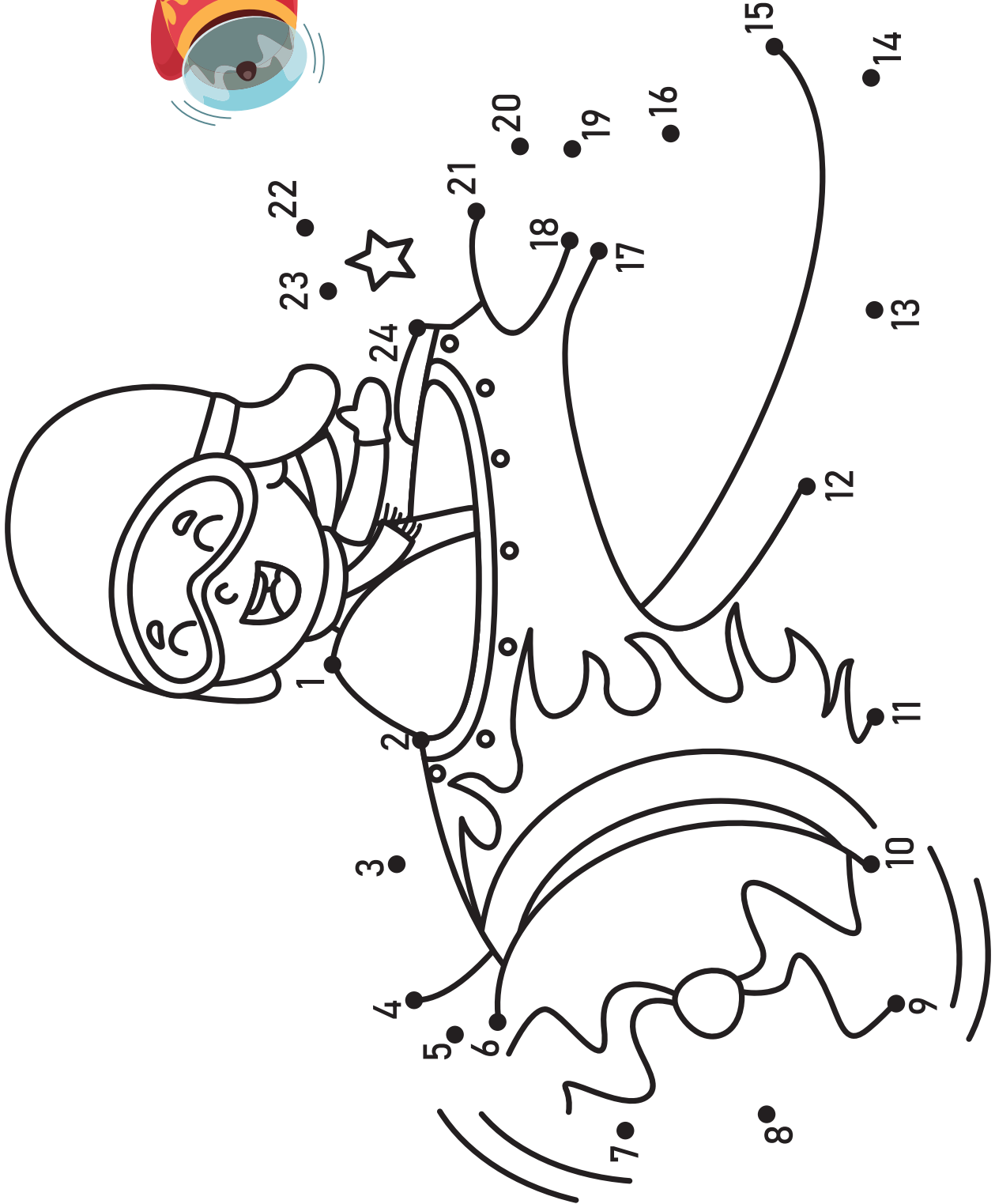

CONNECT THE DOTS

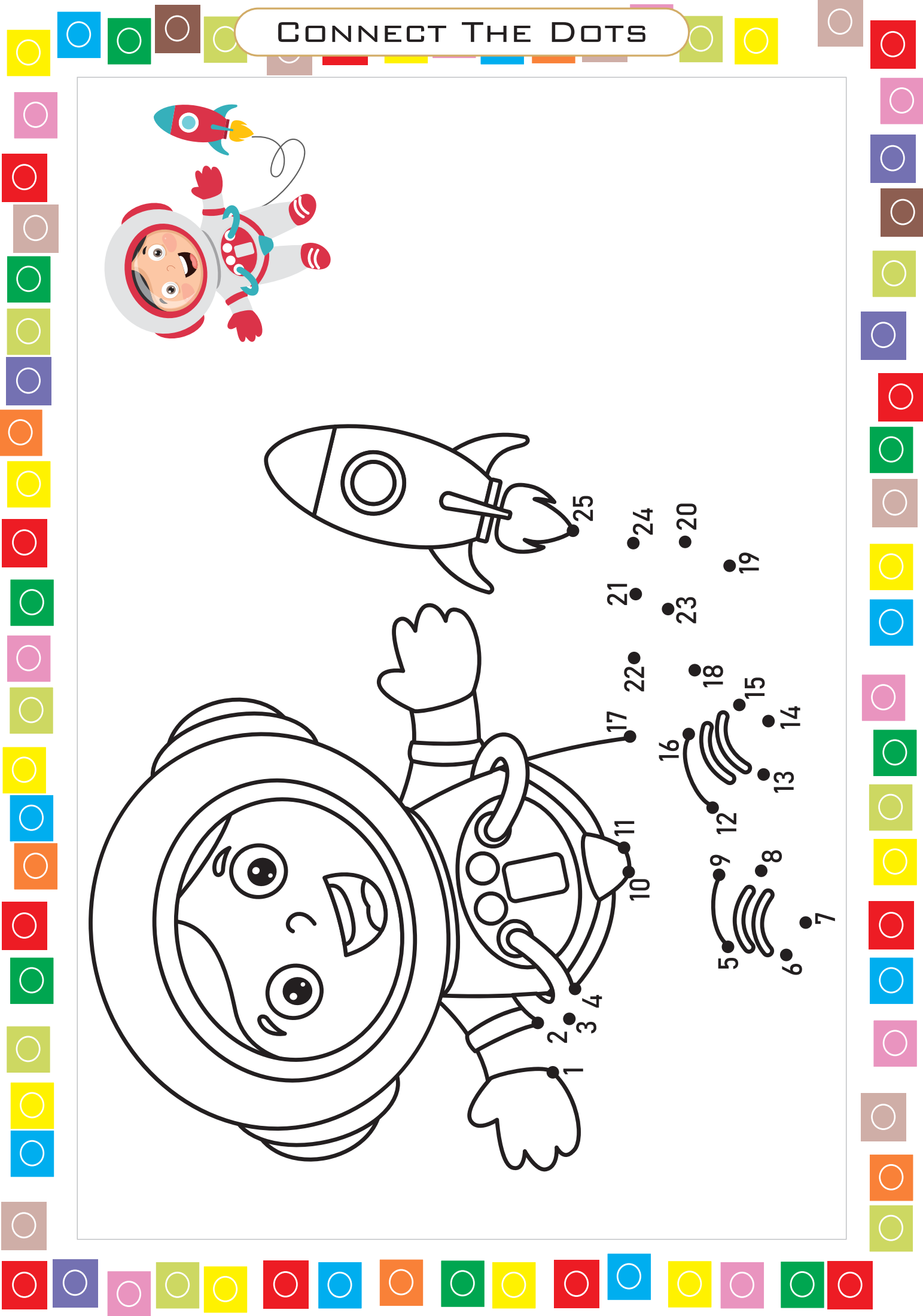
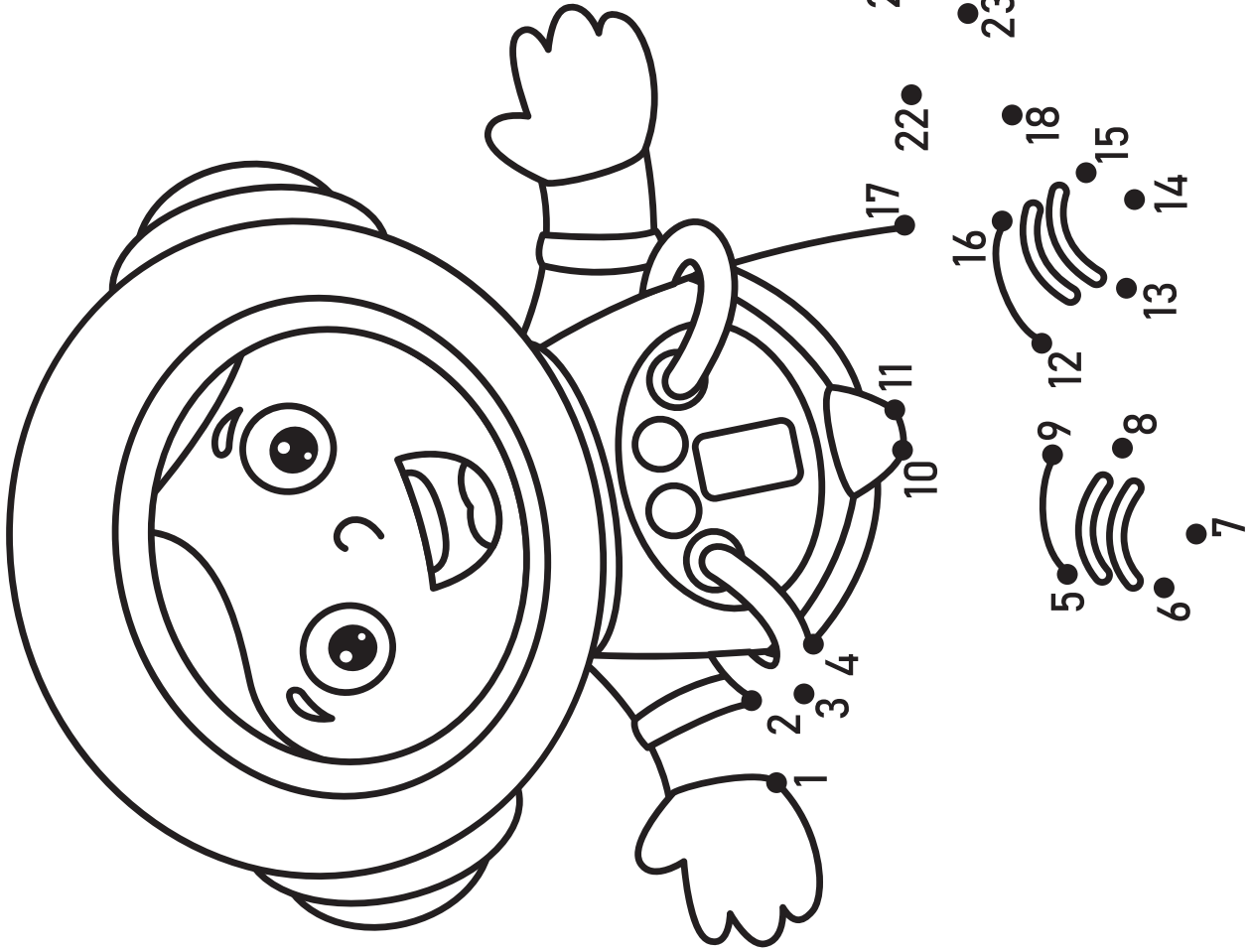
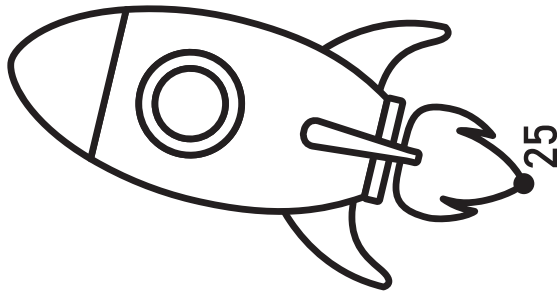
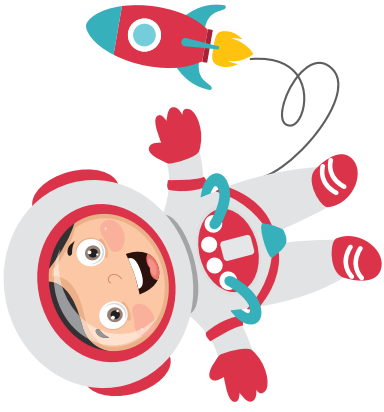

CONNECT THE DOTS

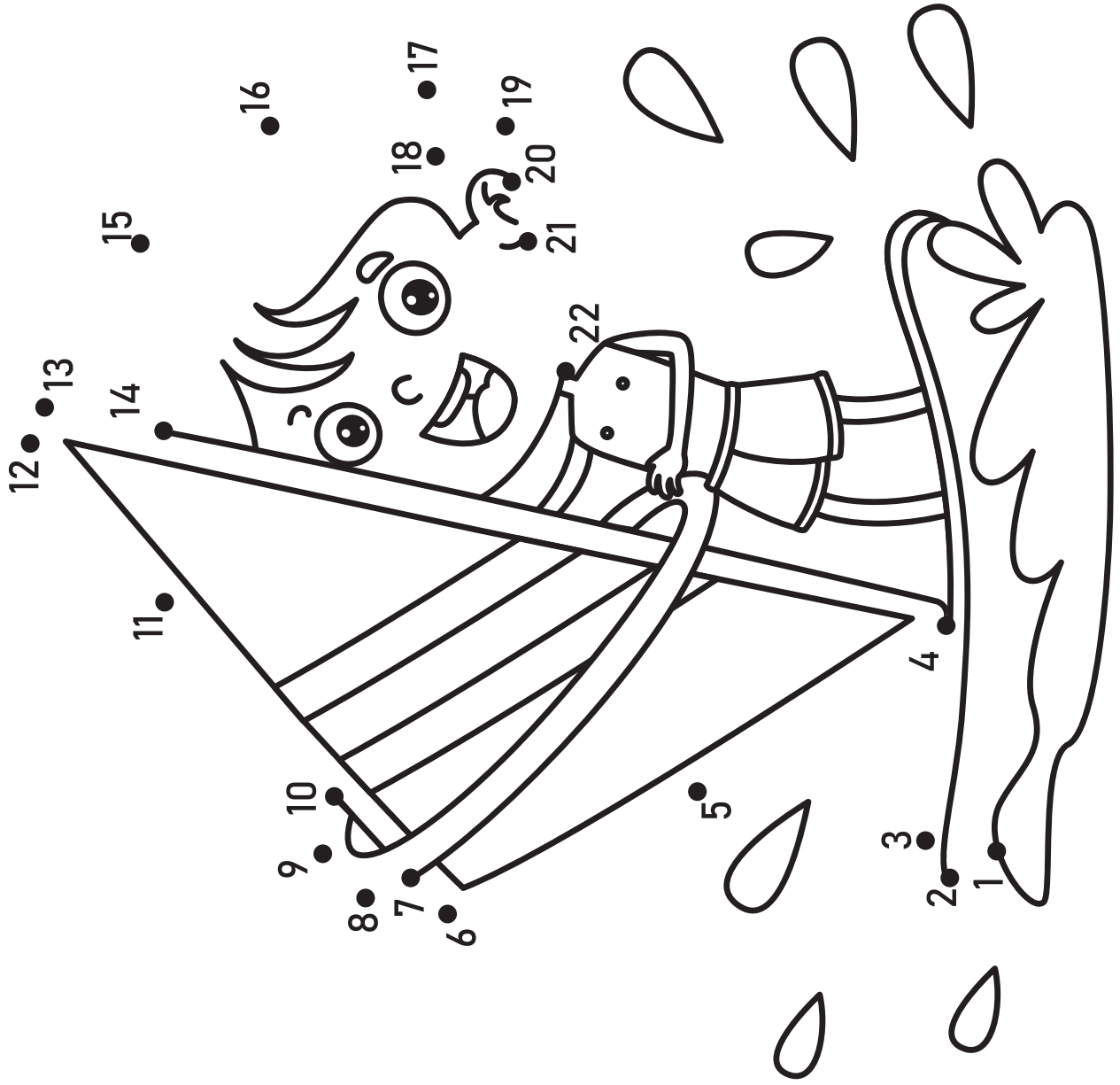

12 ● 13 ●

15 ●

16 ●

18 ●

17 ●

19 ●

20 ●

21 ●

22 ●

14 ●

11 ●

9 ●

10 ●

8 ●

7 ●

6 ●

5 ●

3 ●

4 ●

2 ●

1 ●

CONNECT THE DOTS

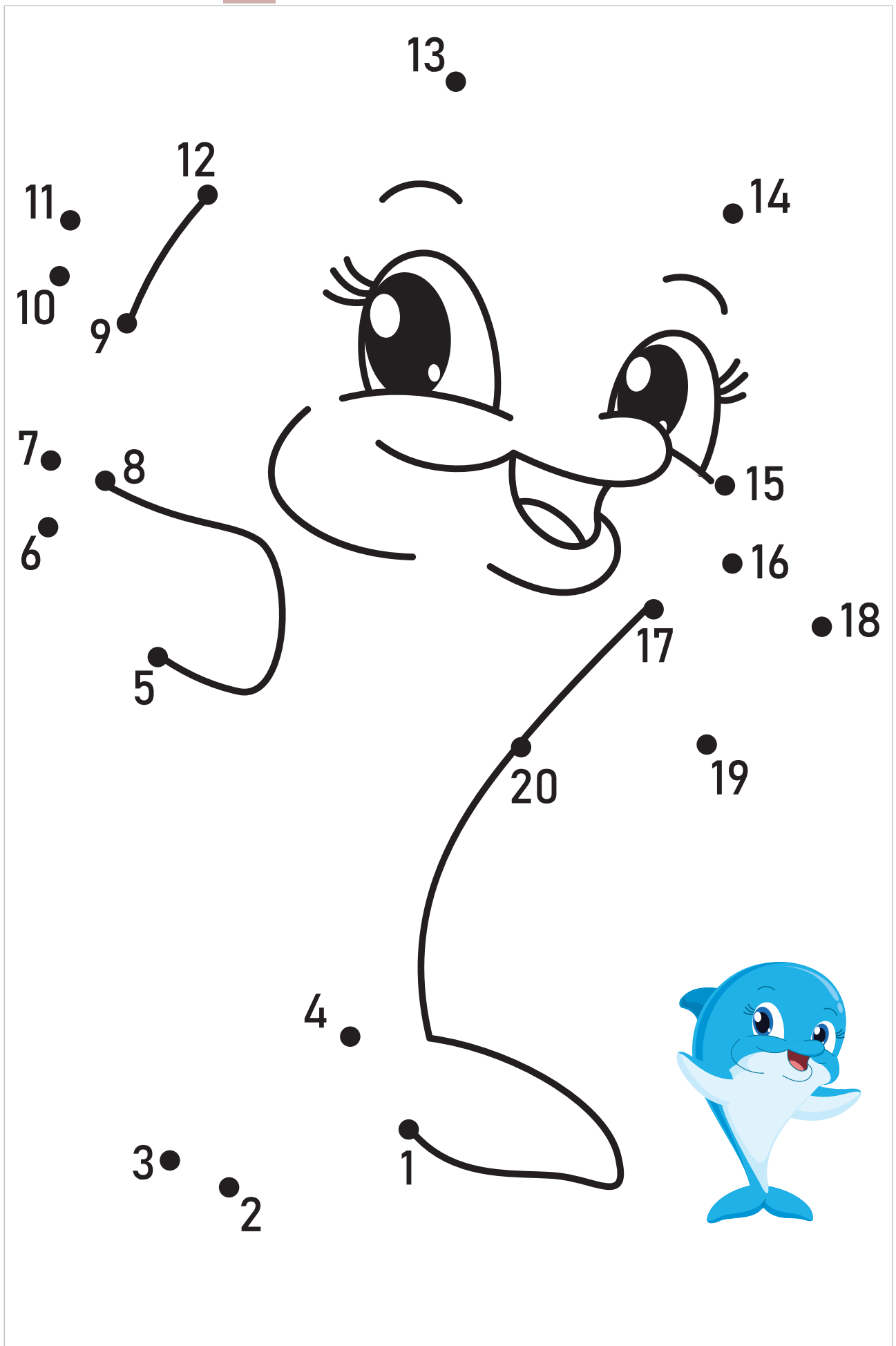

CONNECT THE DOTS

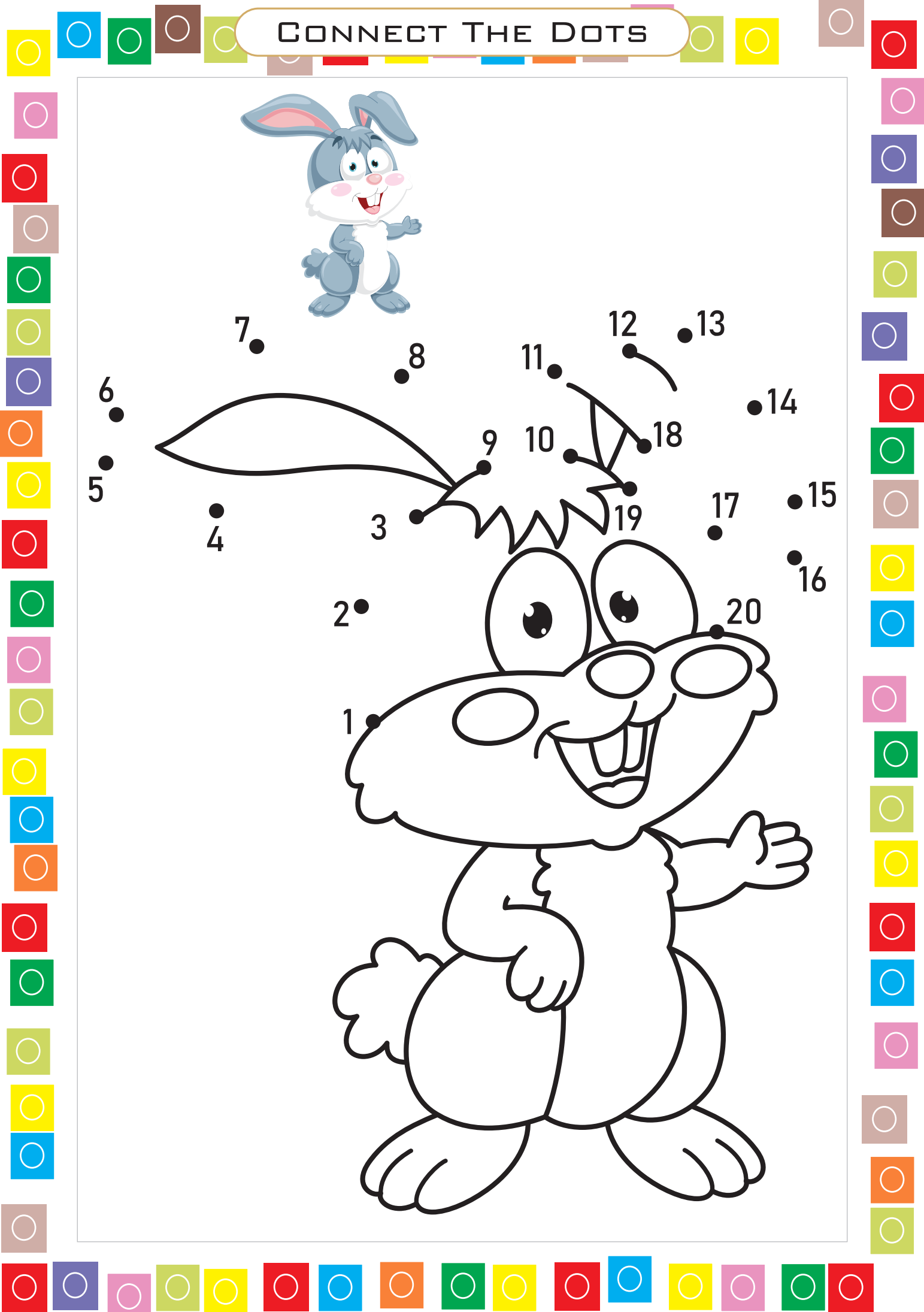
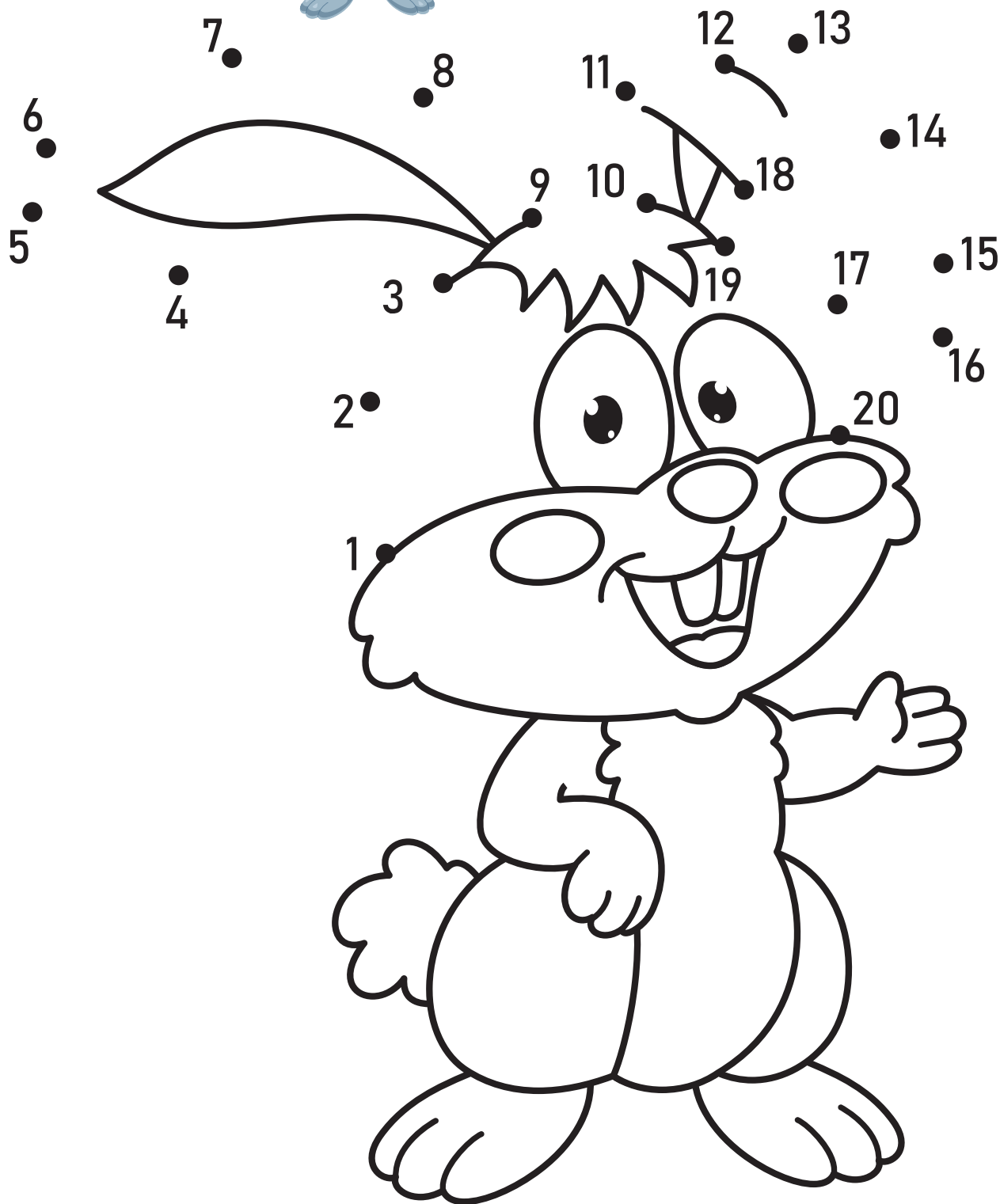

CONNECT THE DOTS

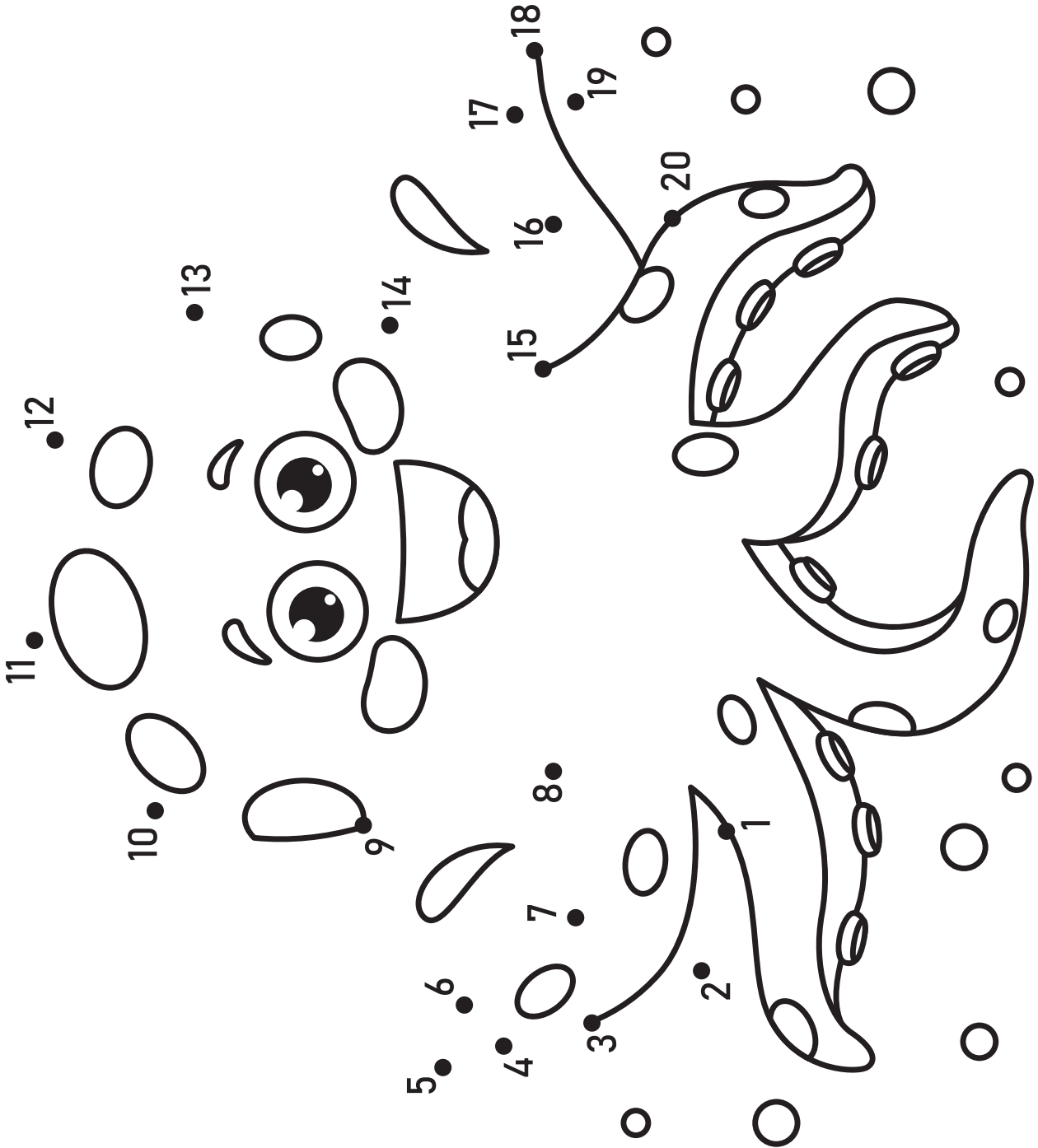
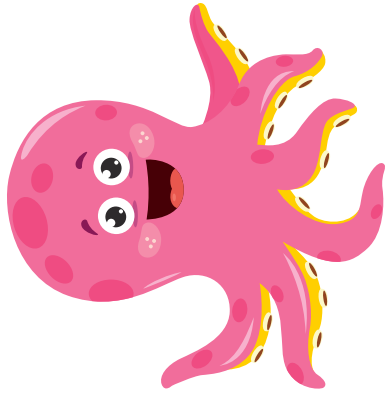

CONNECT THE DOTS

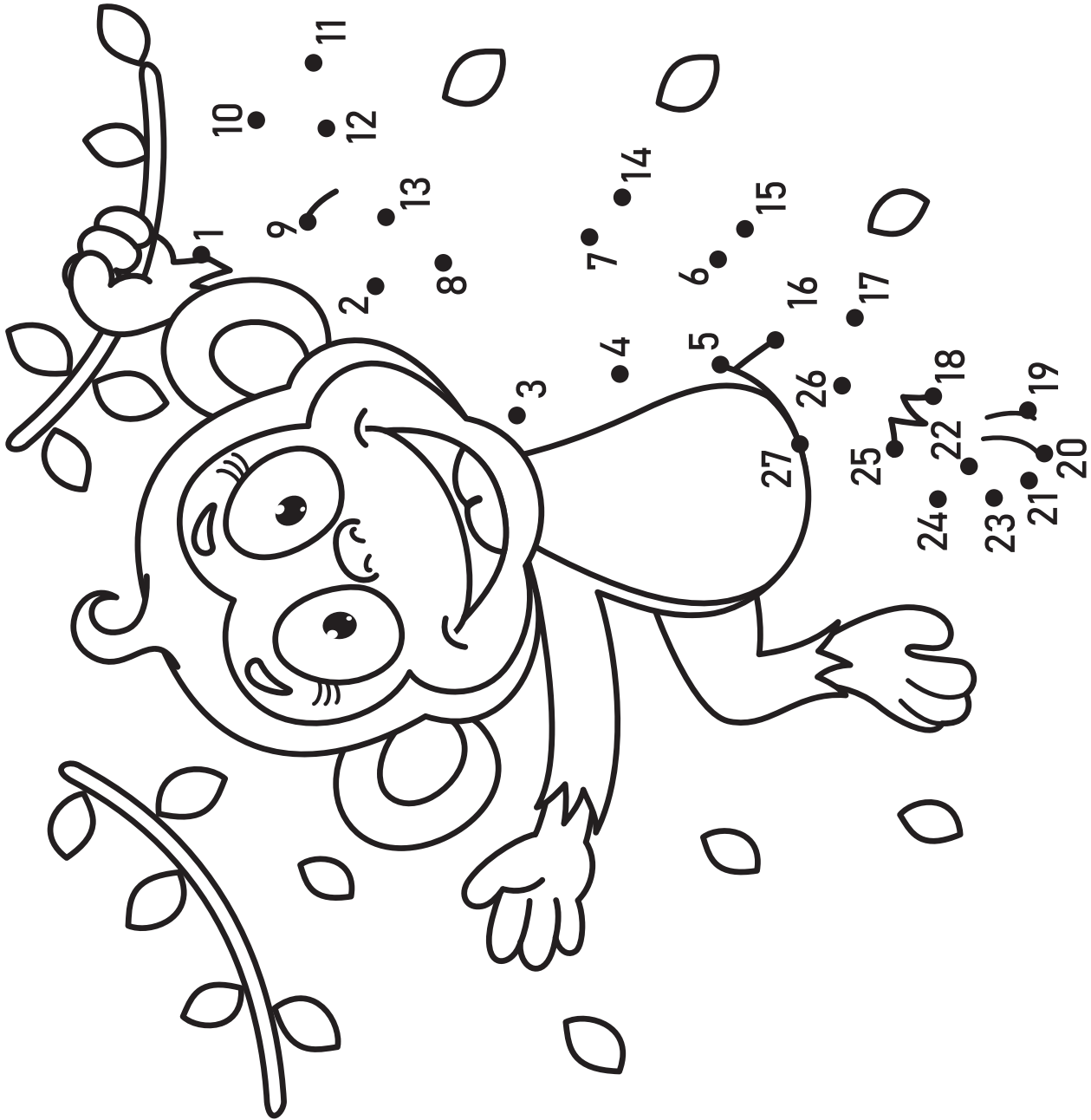

CONNECT THE DOTS

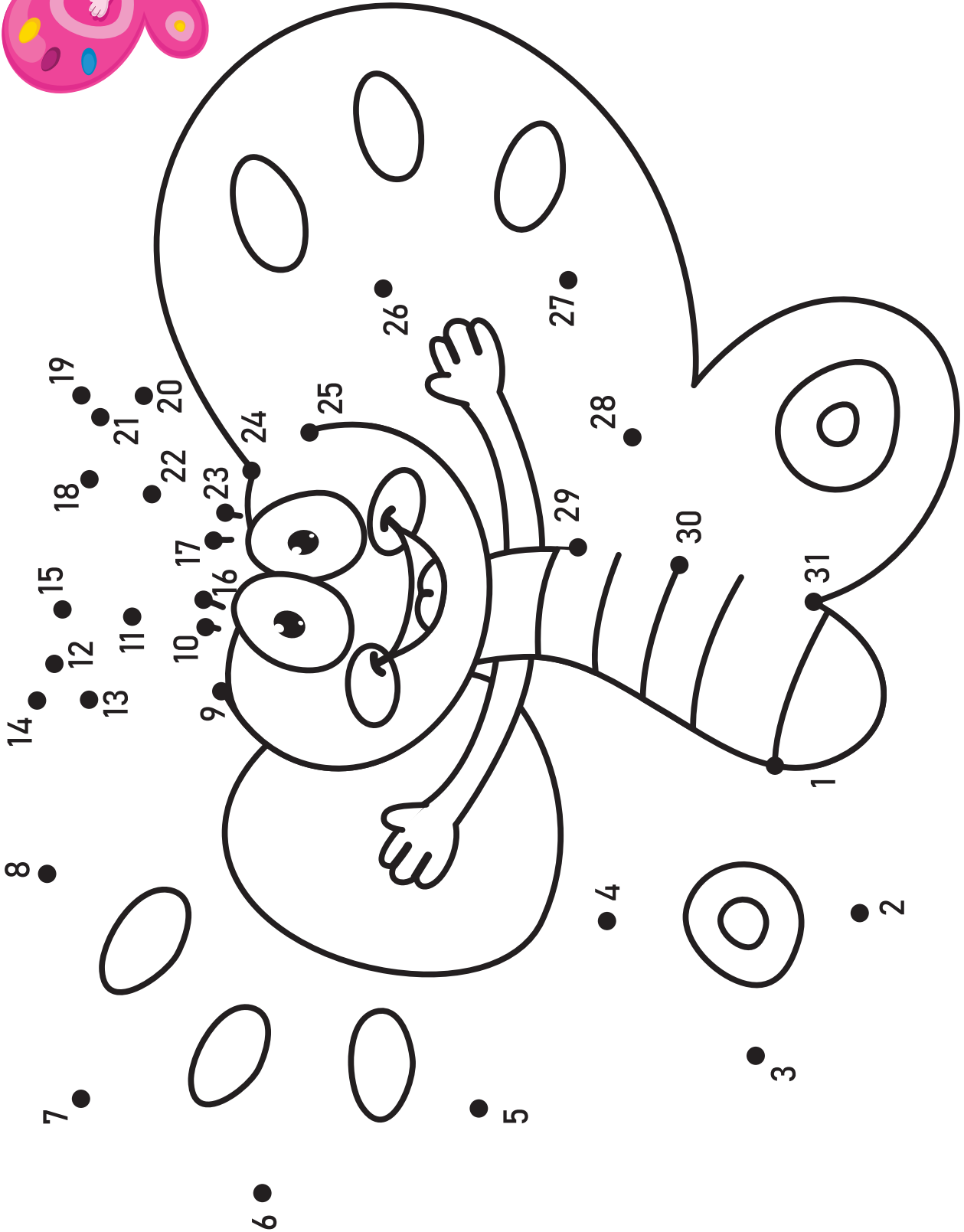

CONNECT THE DOTS

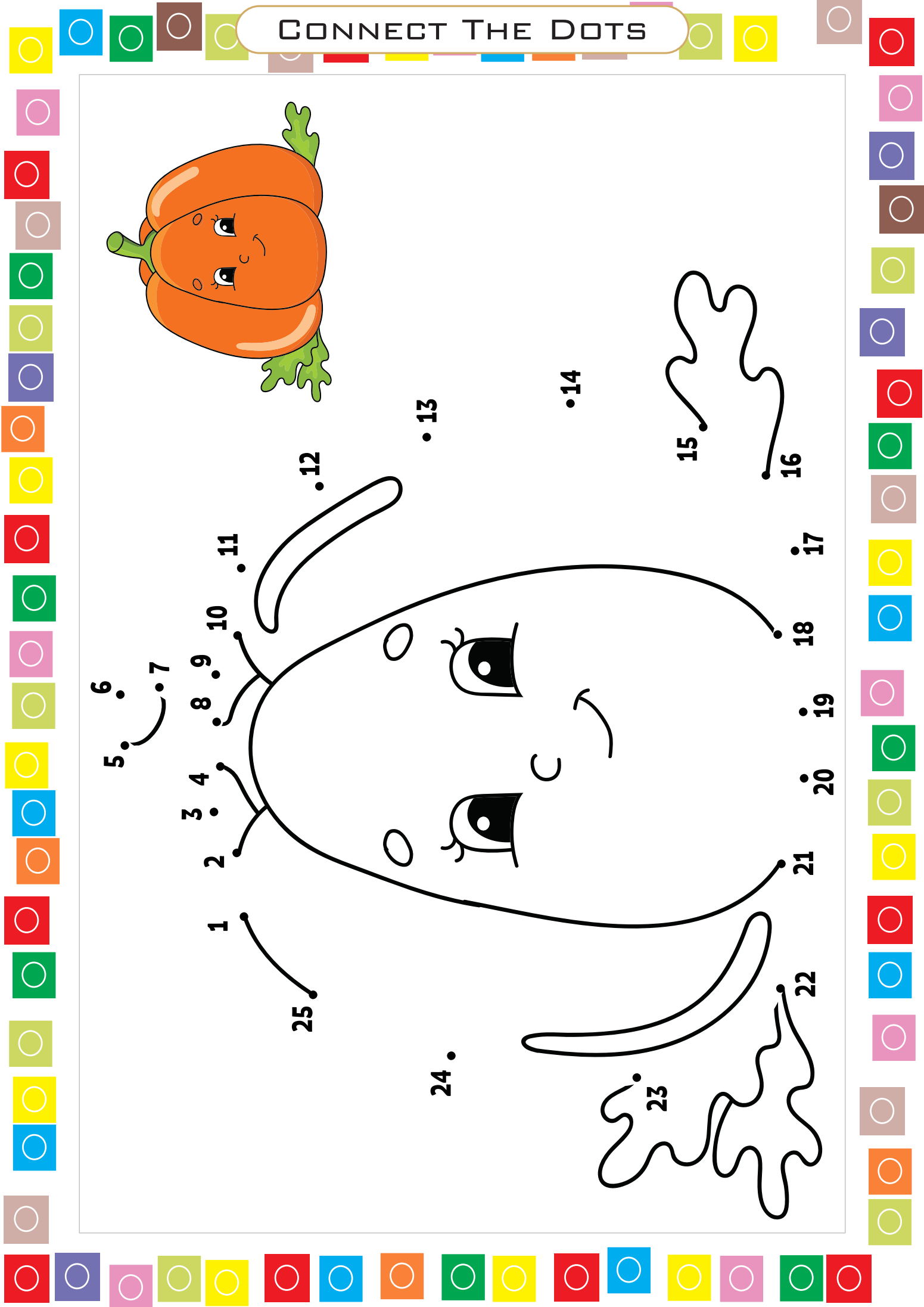
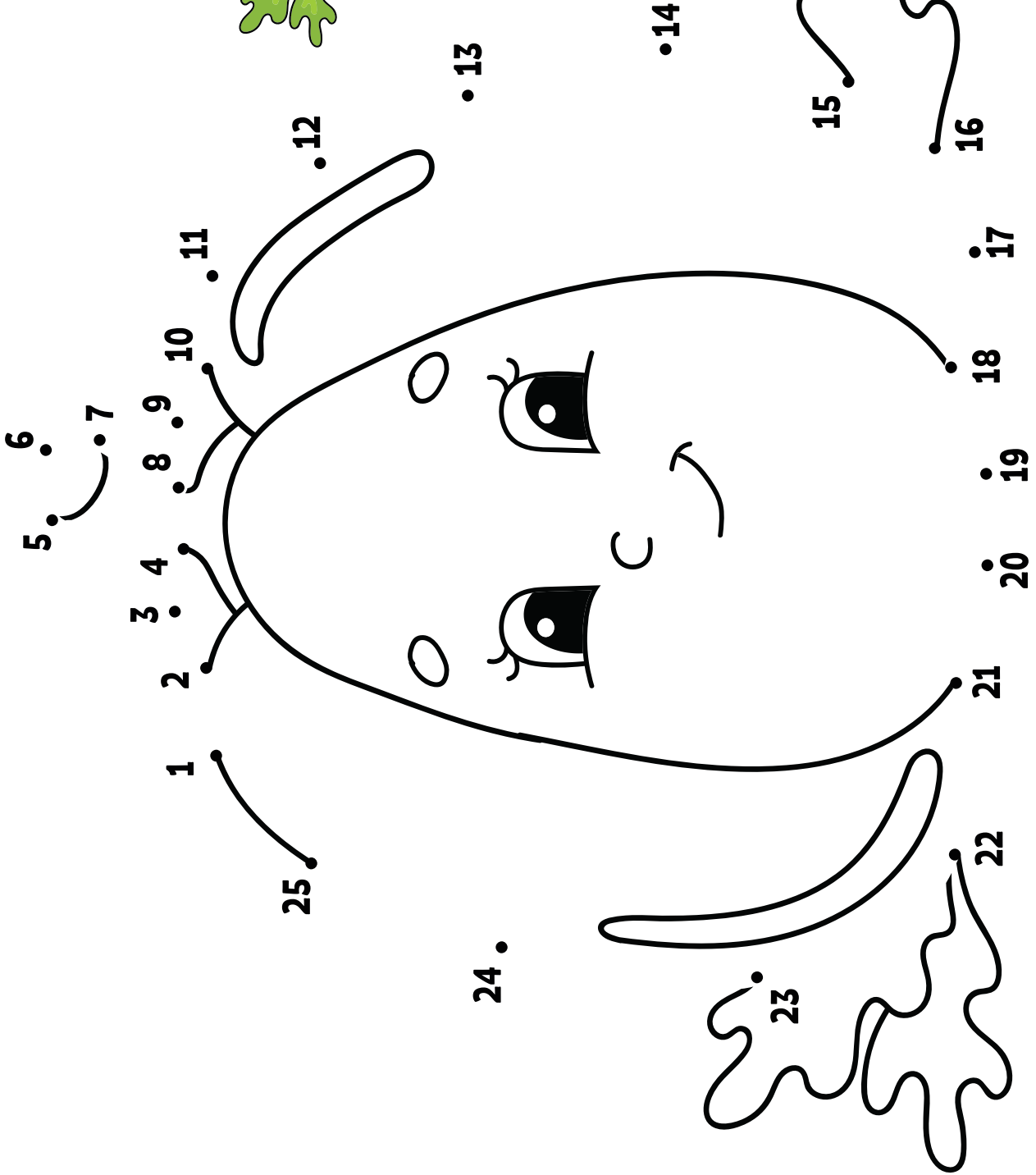
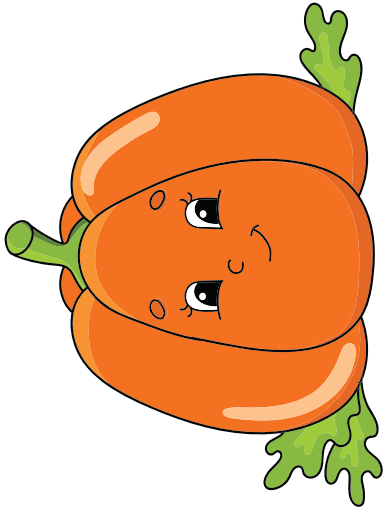

CONNECT THE DOTS

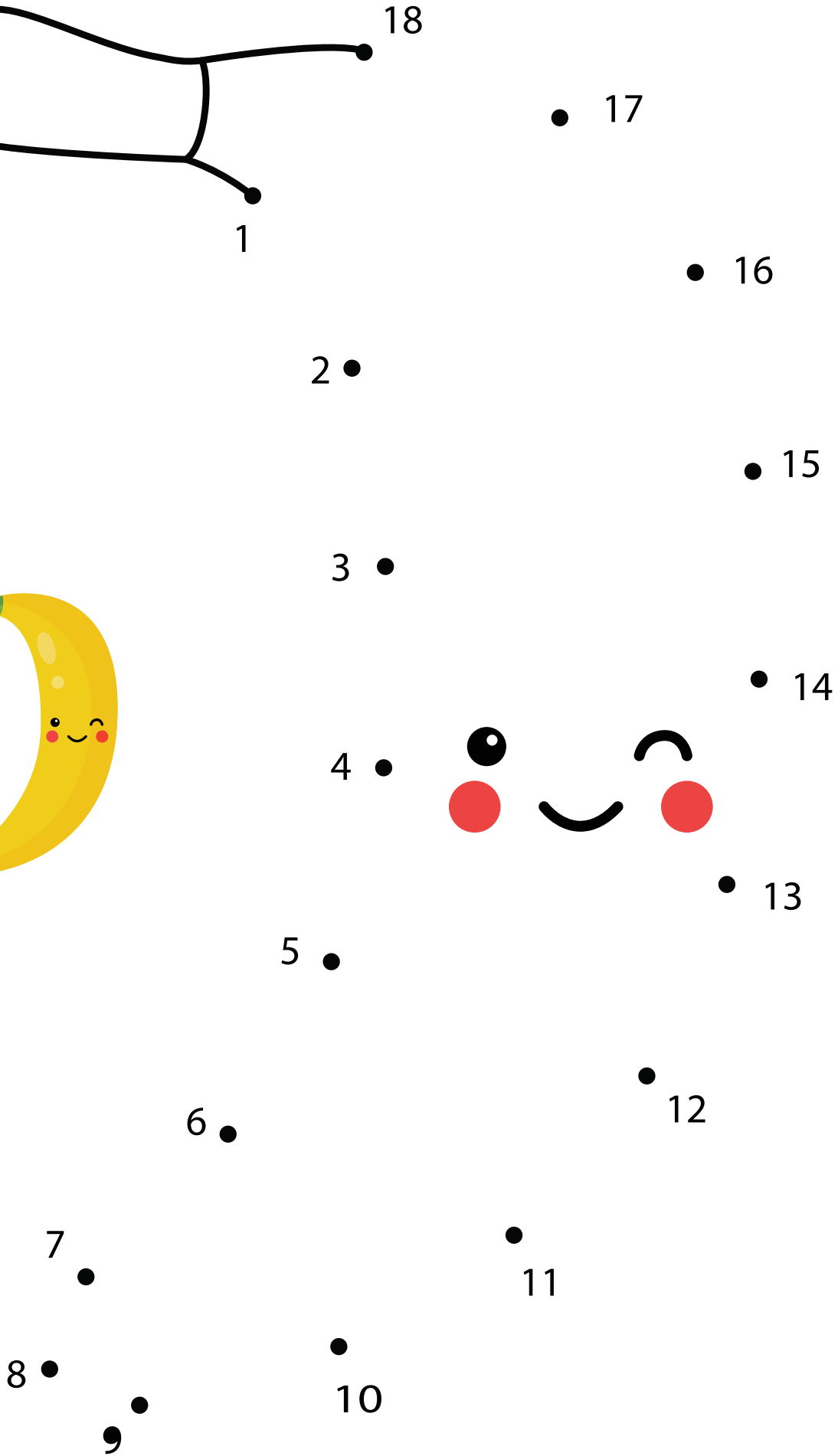
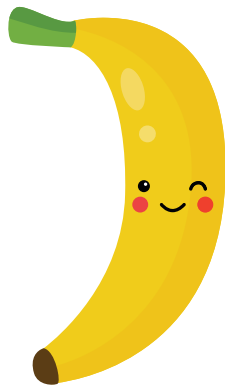
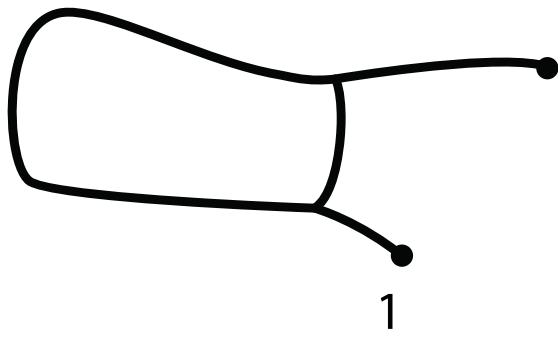

CONNECT THE DOTS

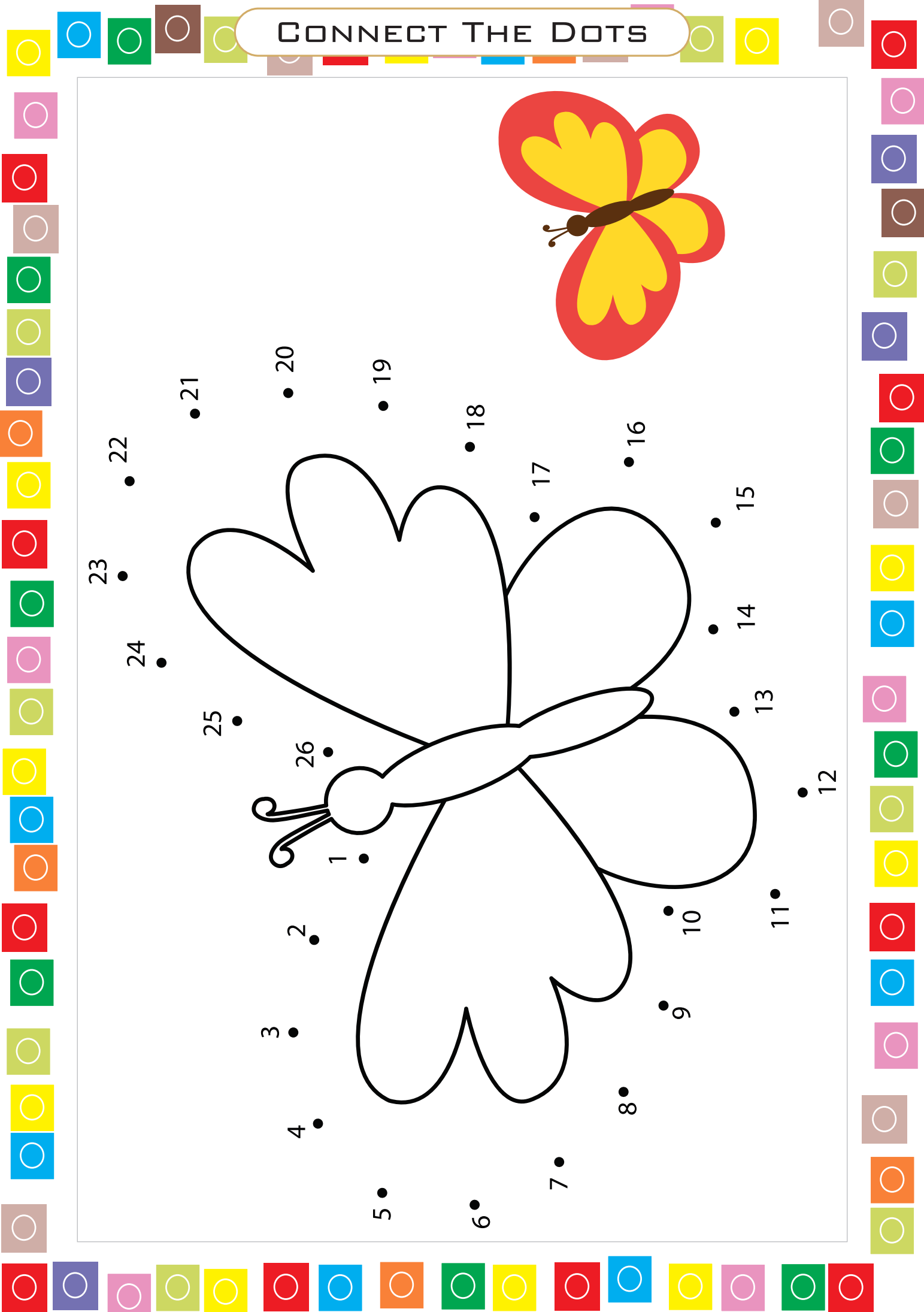
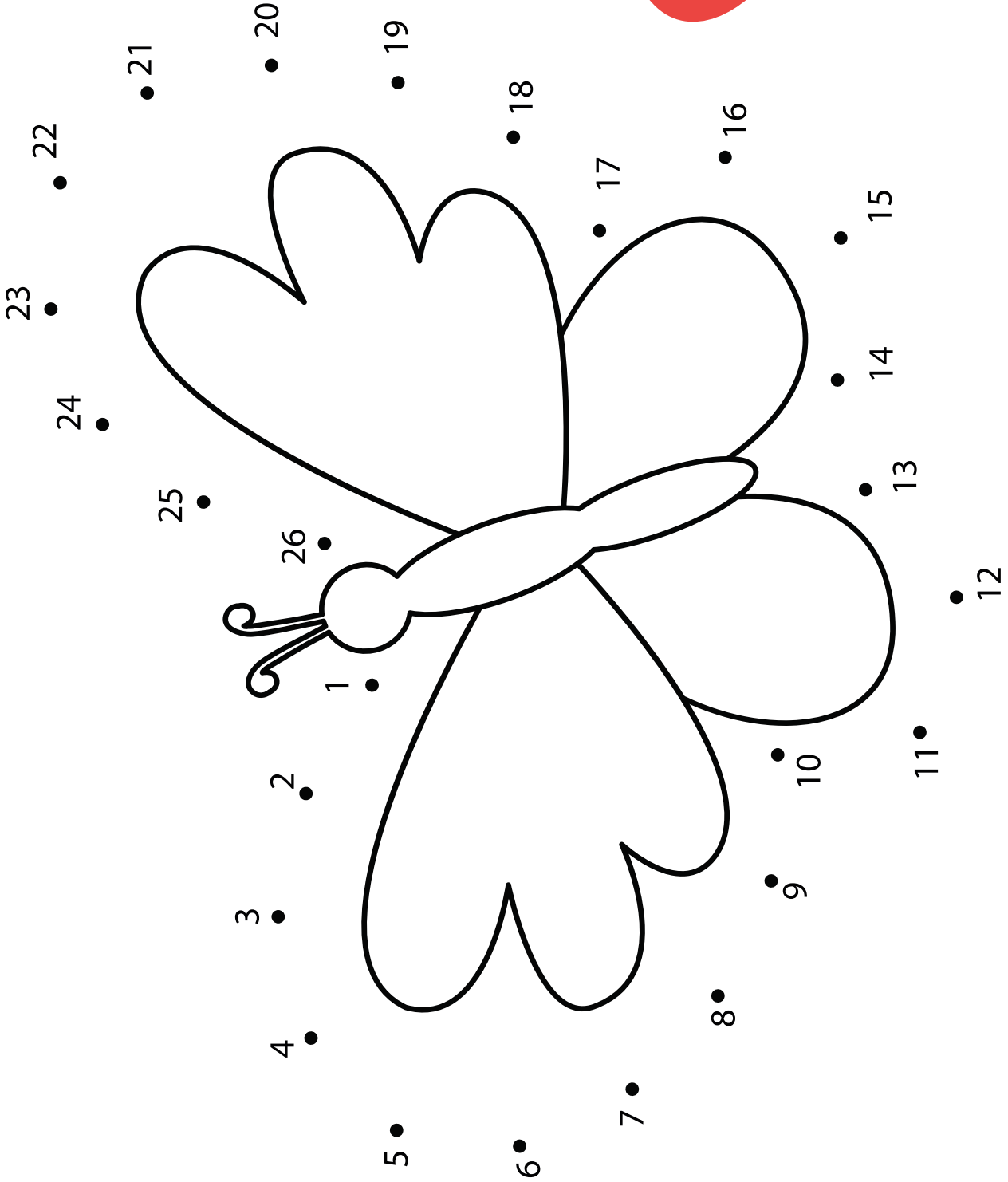
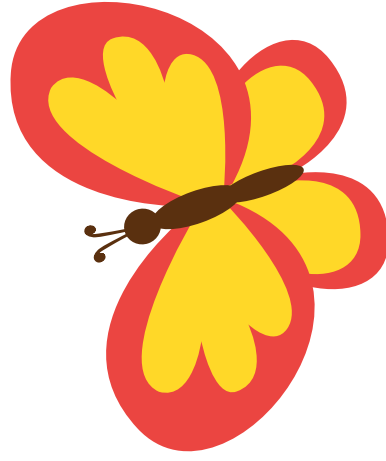

CONNECT THE DOTS

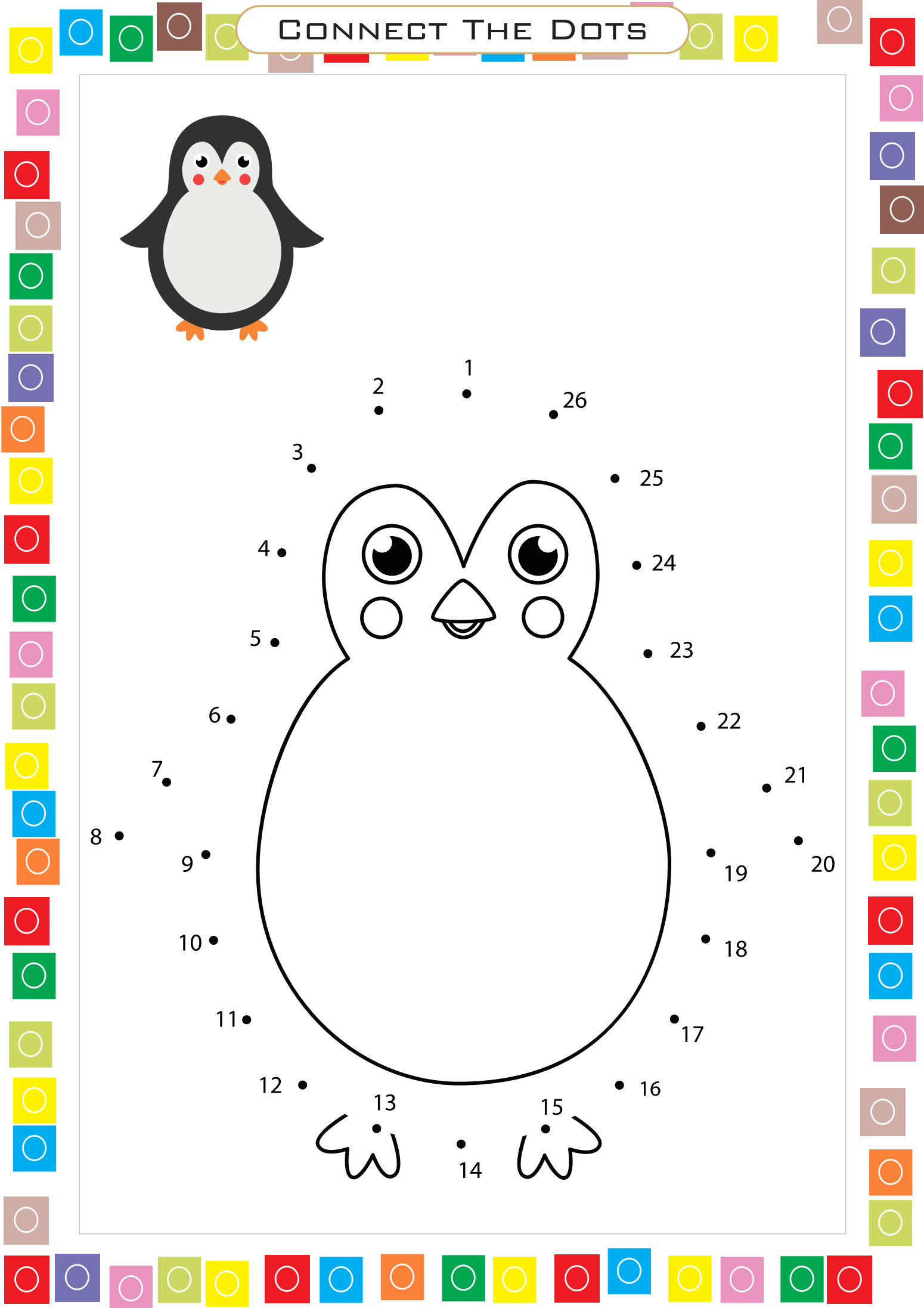
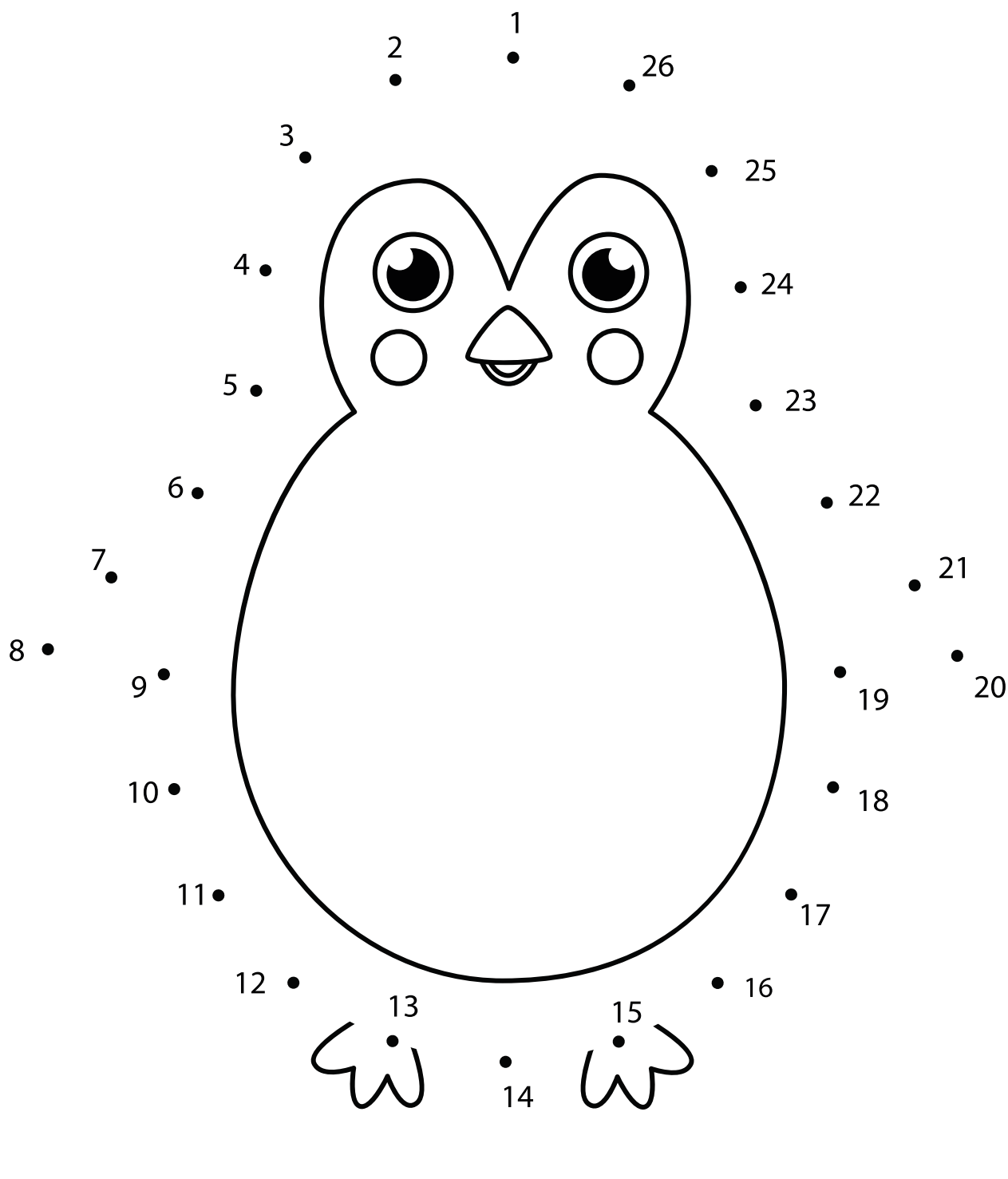
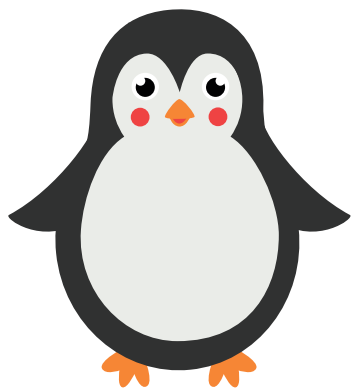

CONNECT THE DOTS

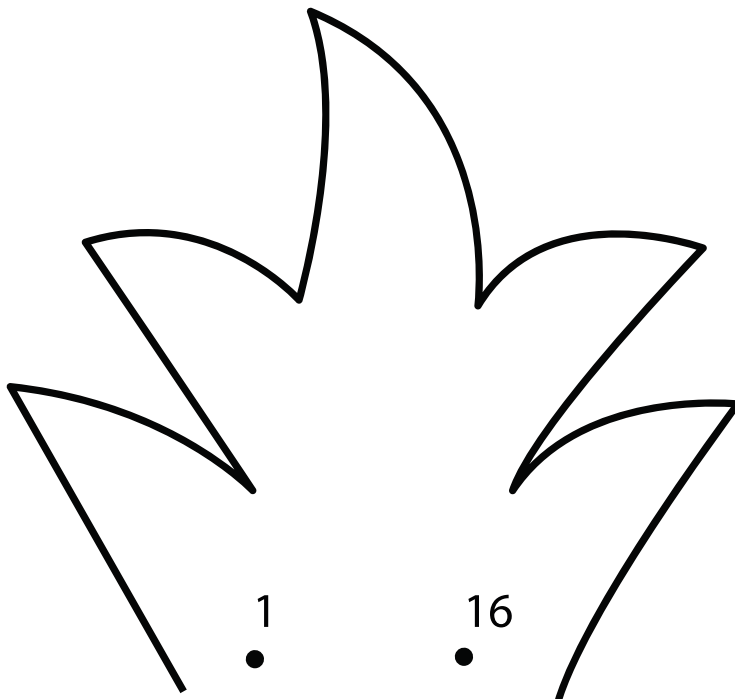

2

1

16

15

3

14

4

13

5

12

6

11

7

10

8

9

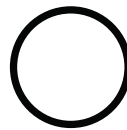
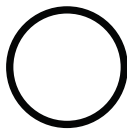

CONNECT THE DOTS

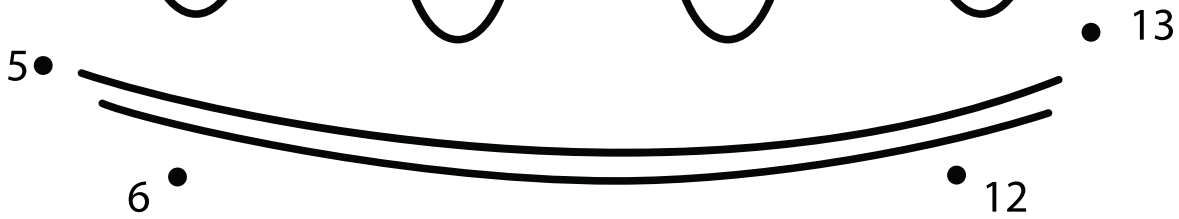
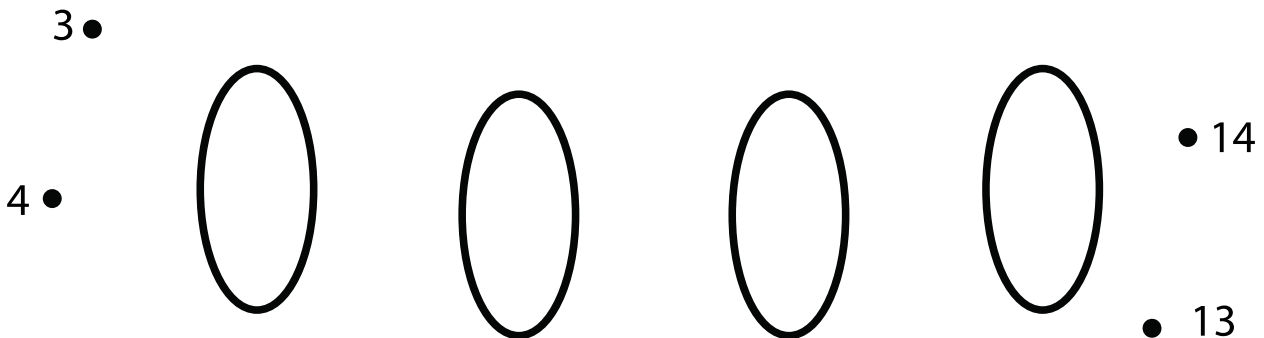
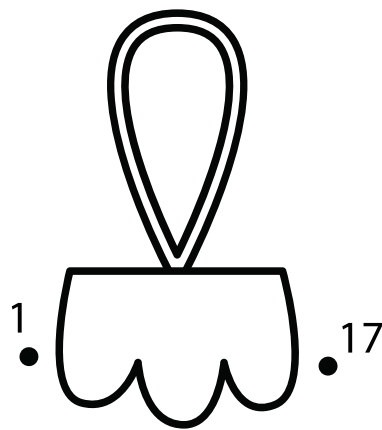

CONNECT THE DOTS

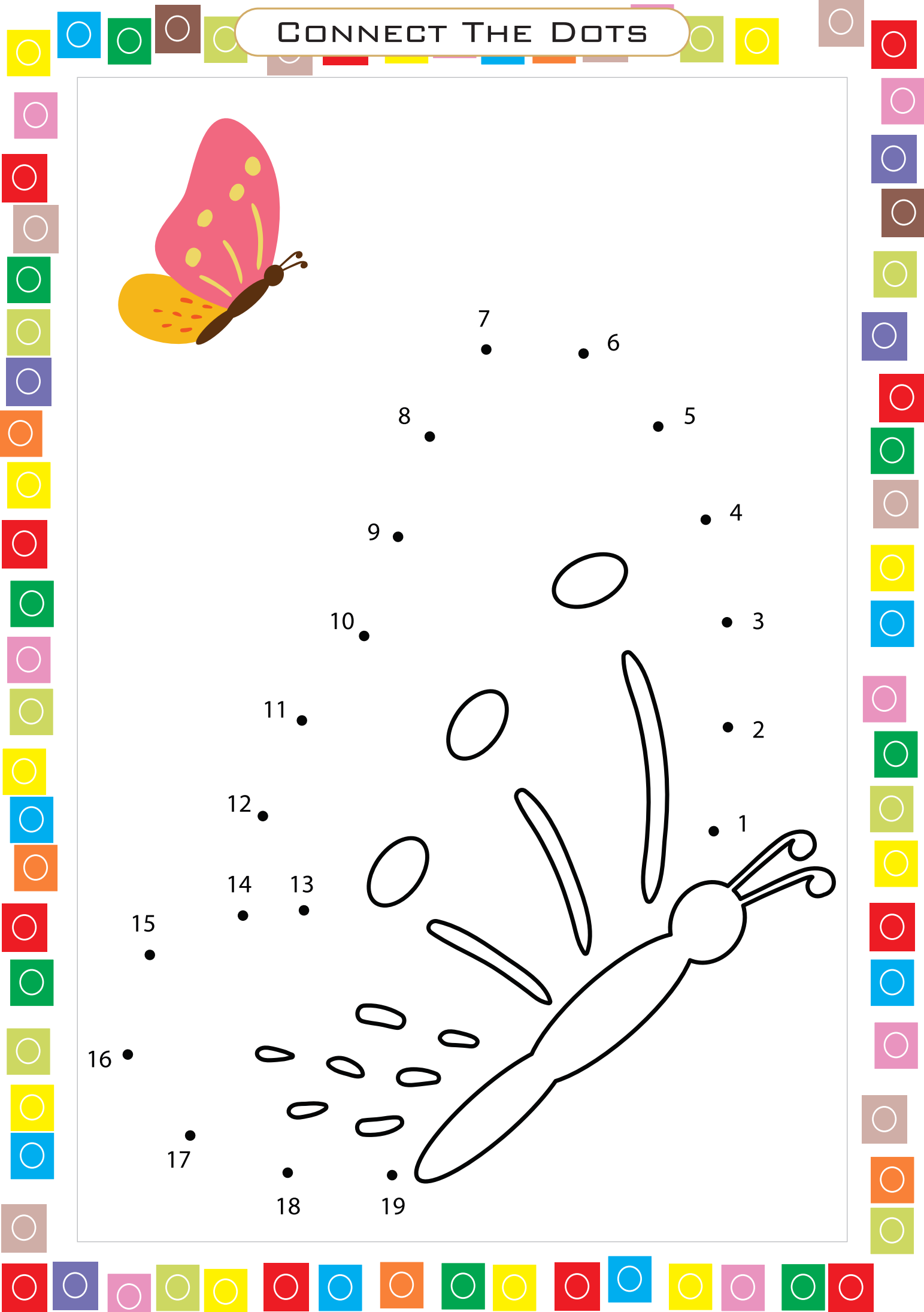
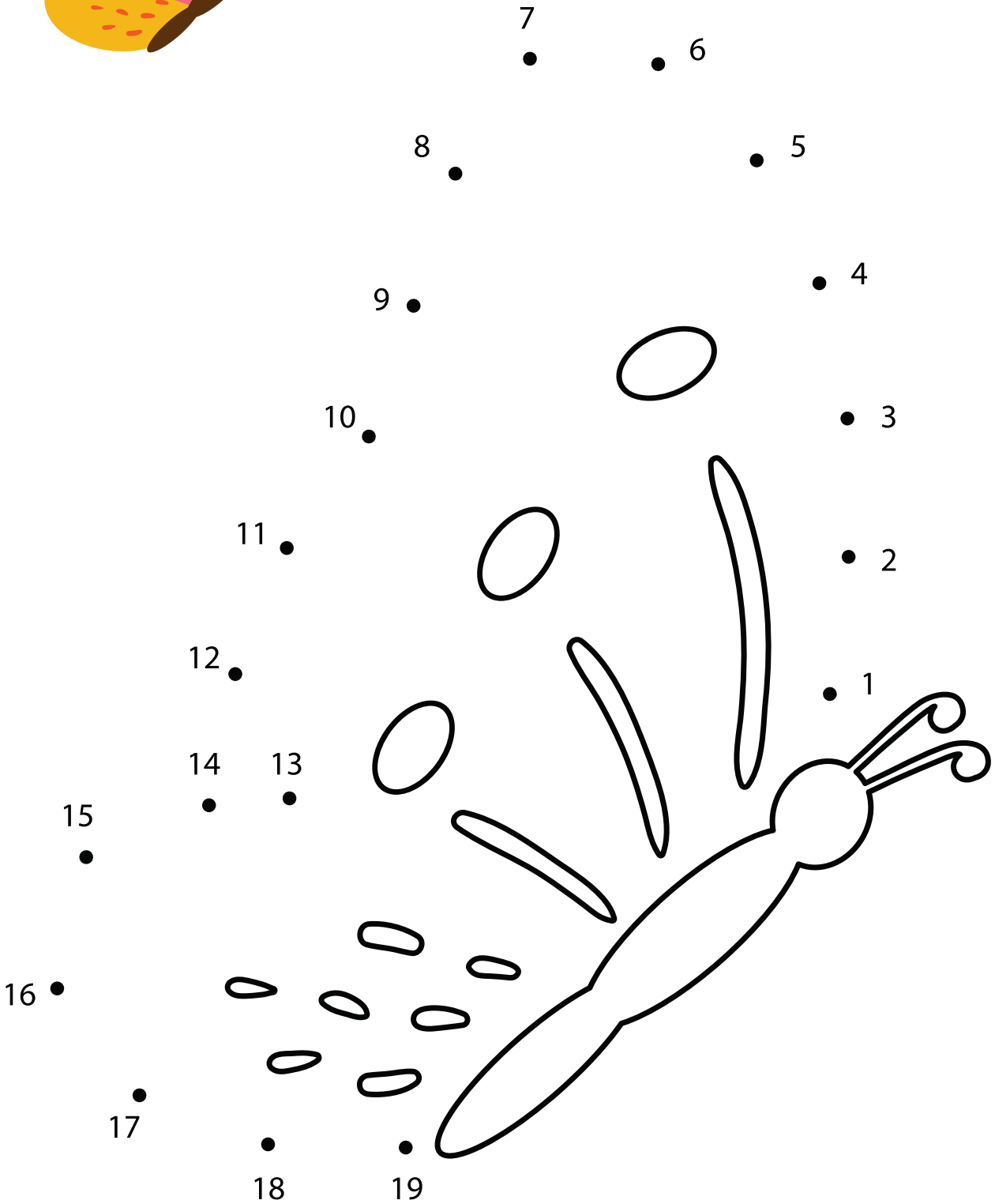
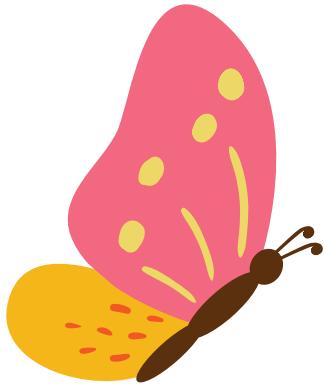

CONNECT THE DOTS

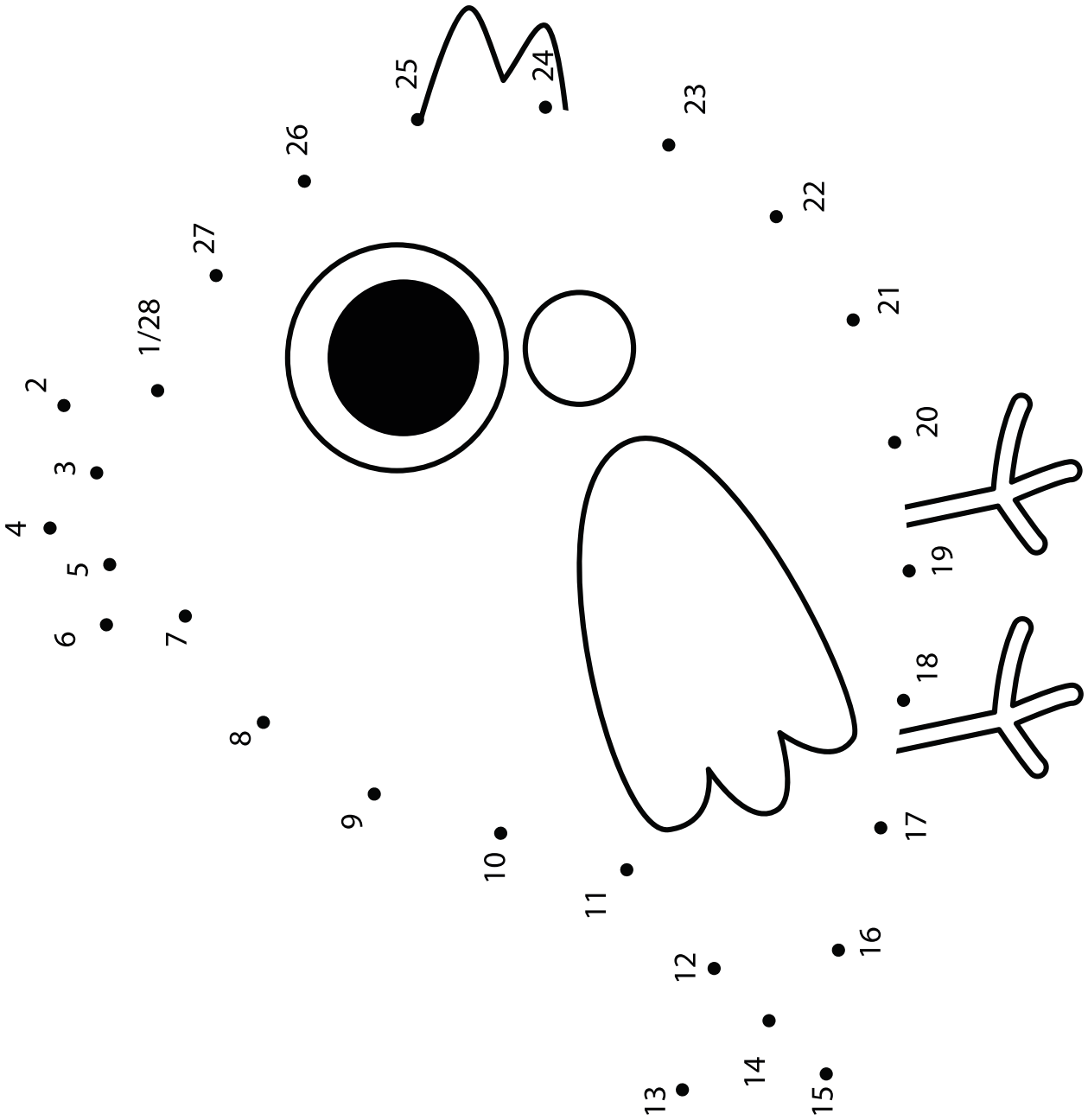
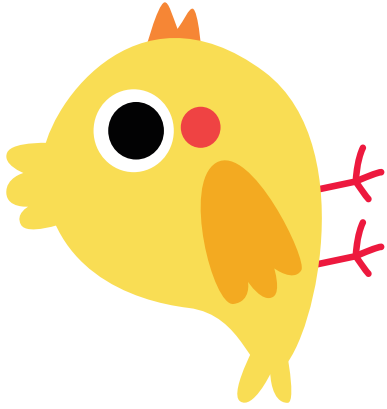

CONNECT THE DOTS

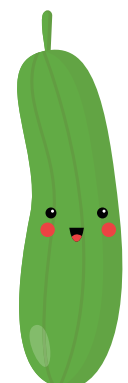
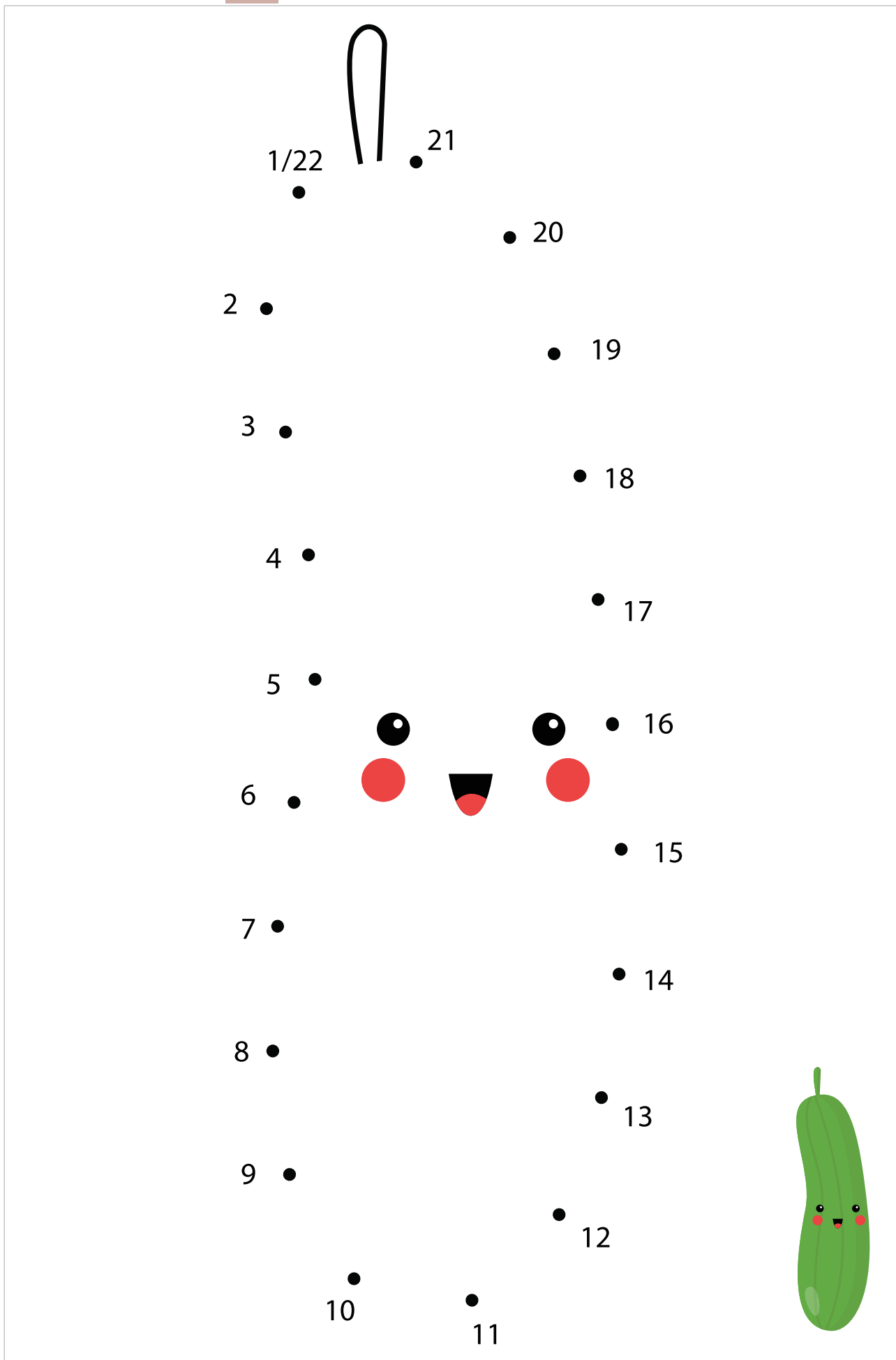

CONNECT THE DOTS

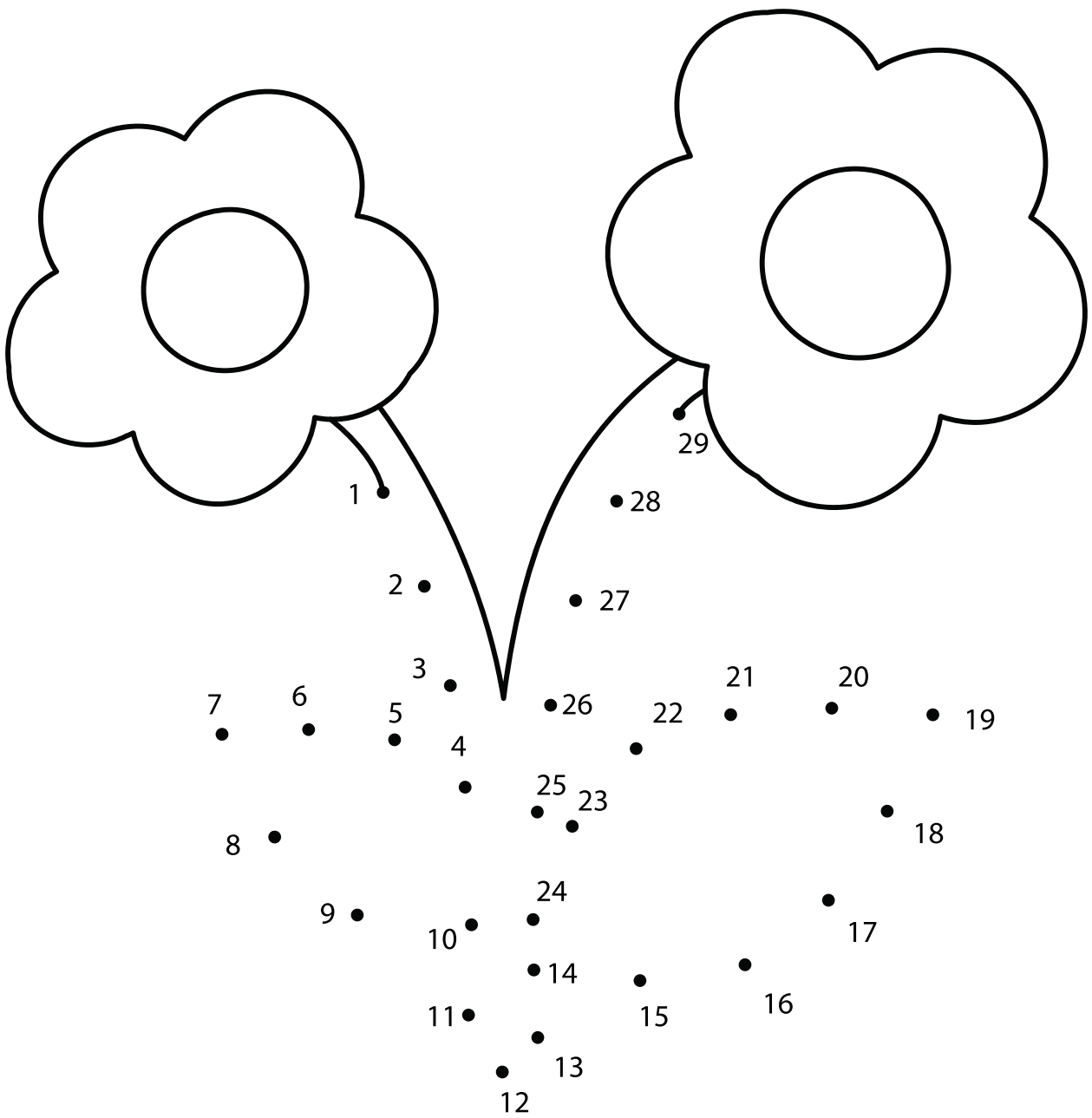
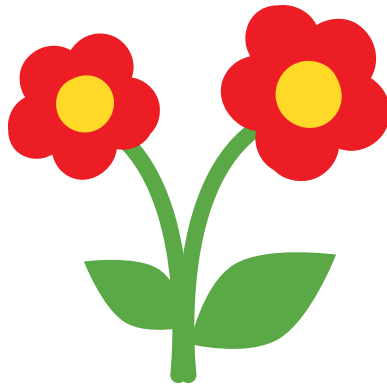

CONNECT THE DOTS

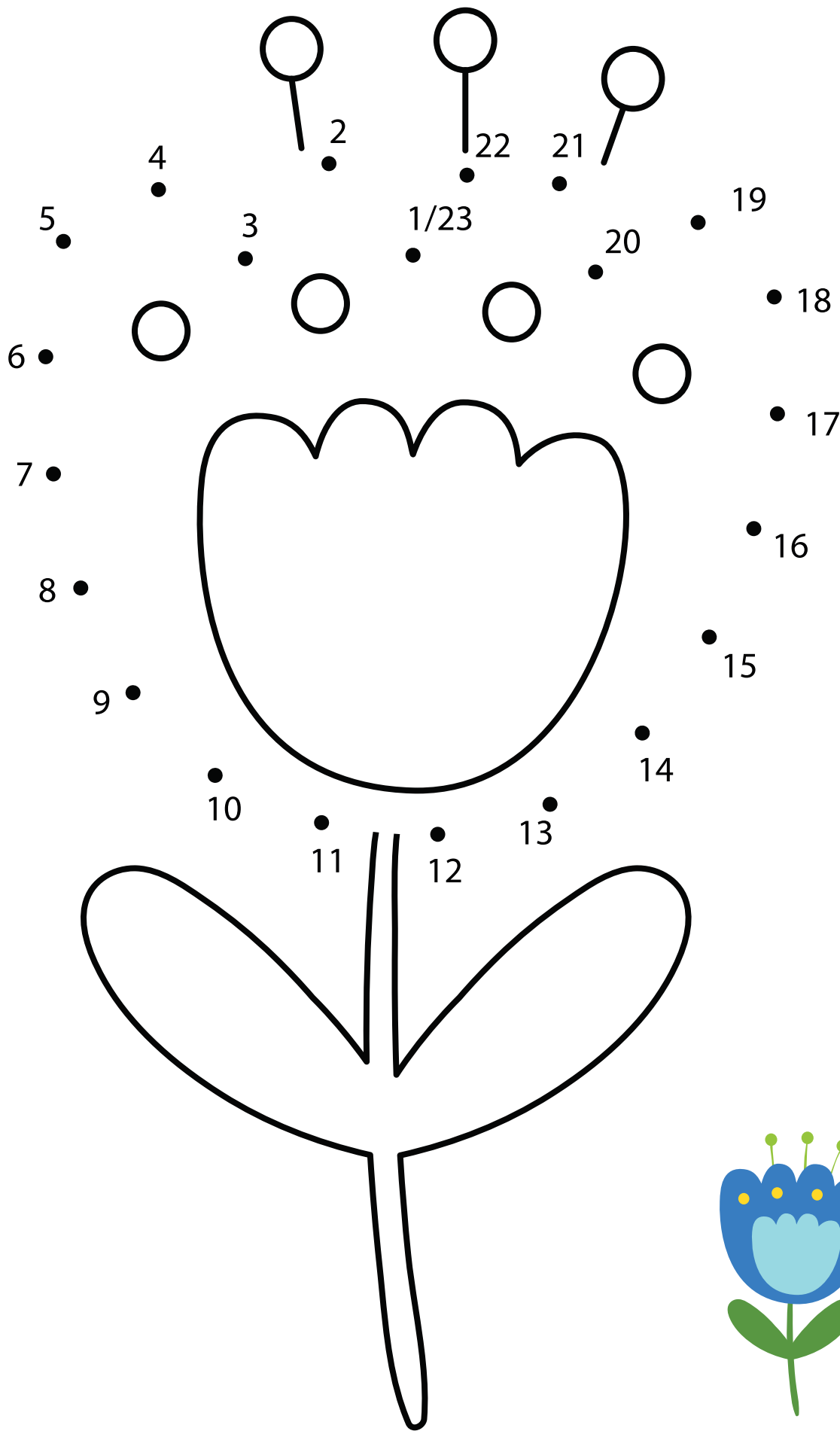

CONNECT THE DOTS

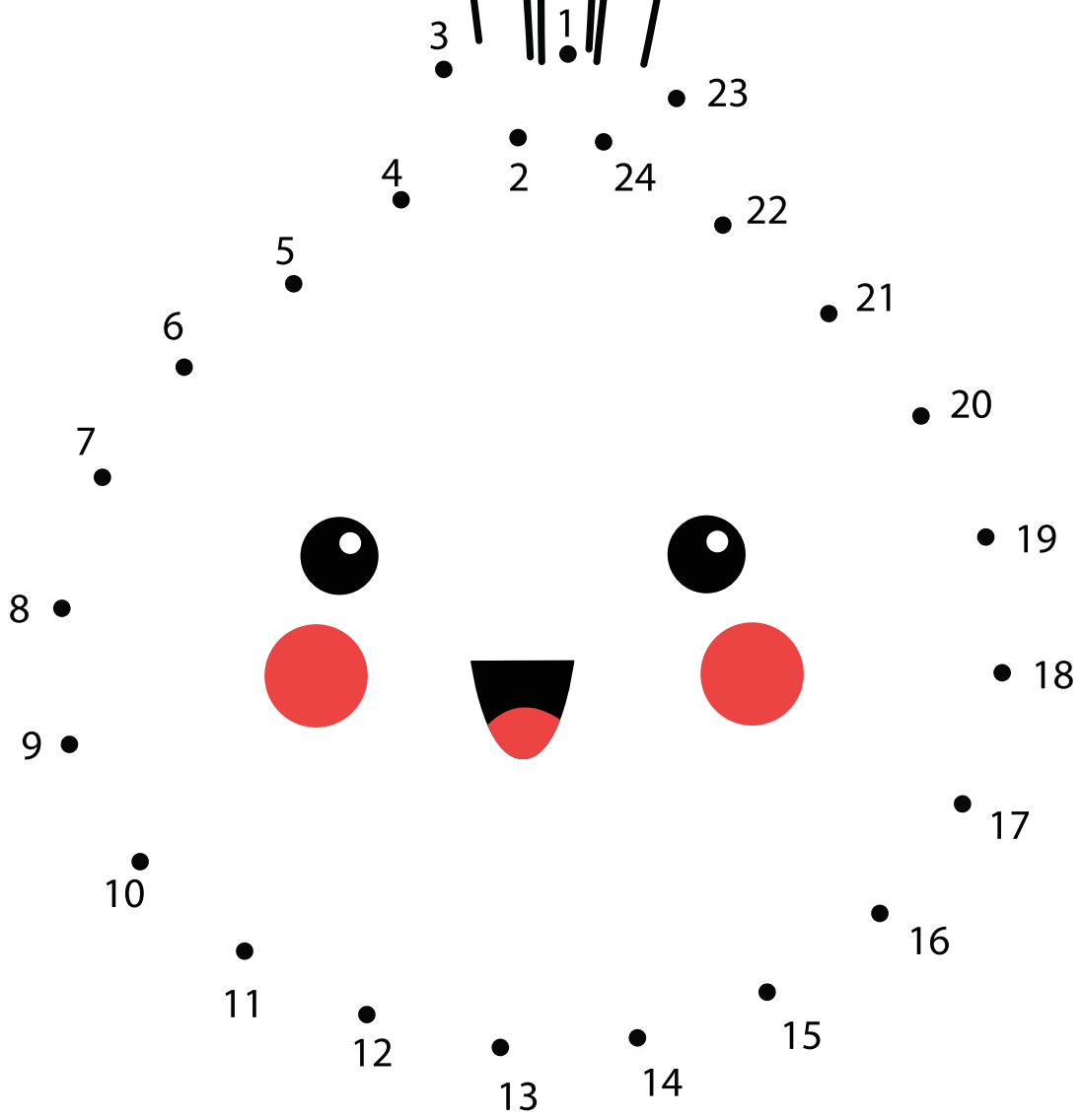
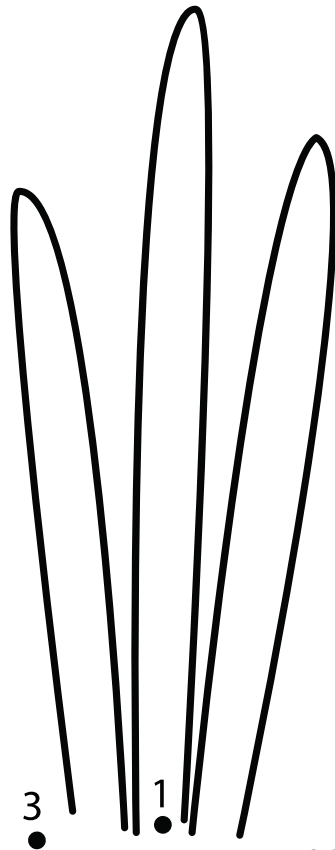
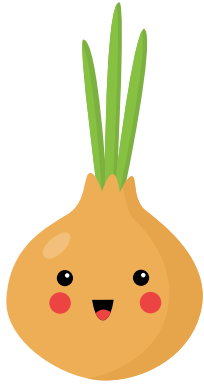

CONNECT THE DOTS

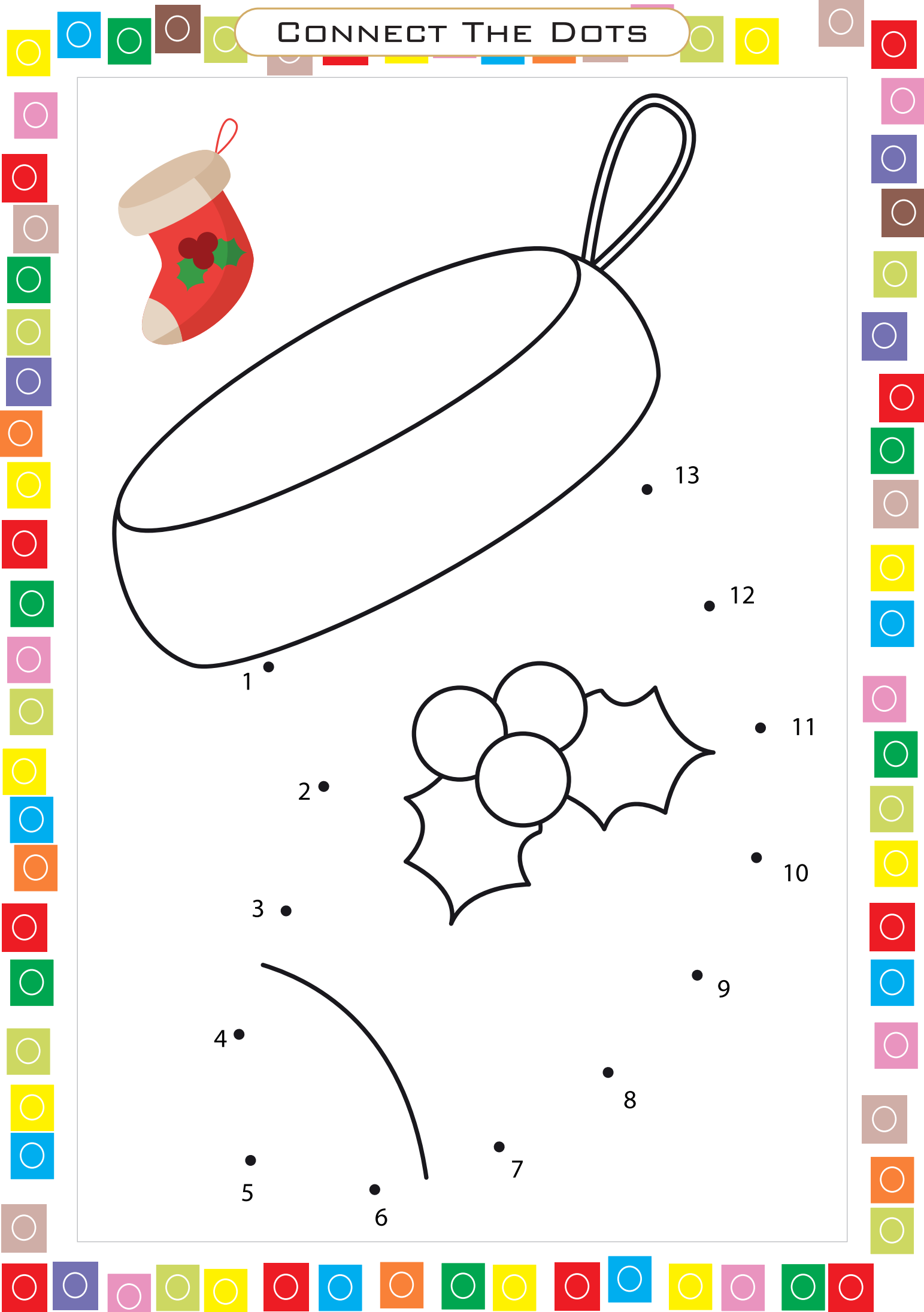
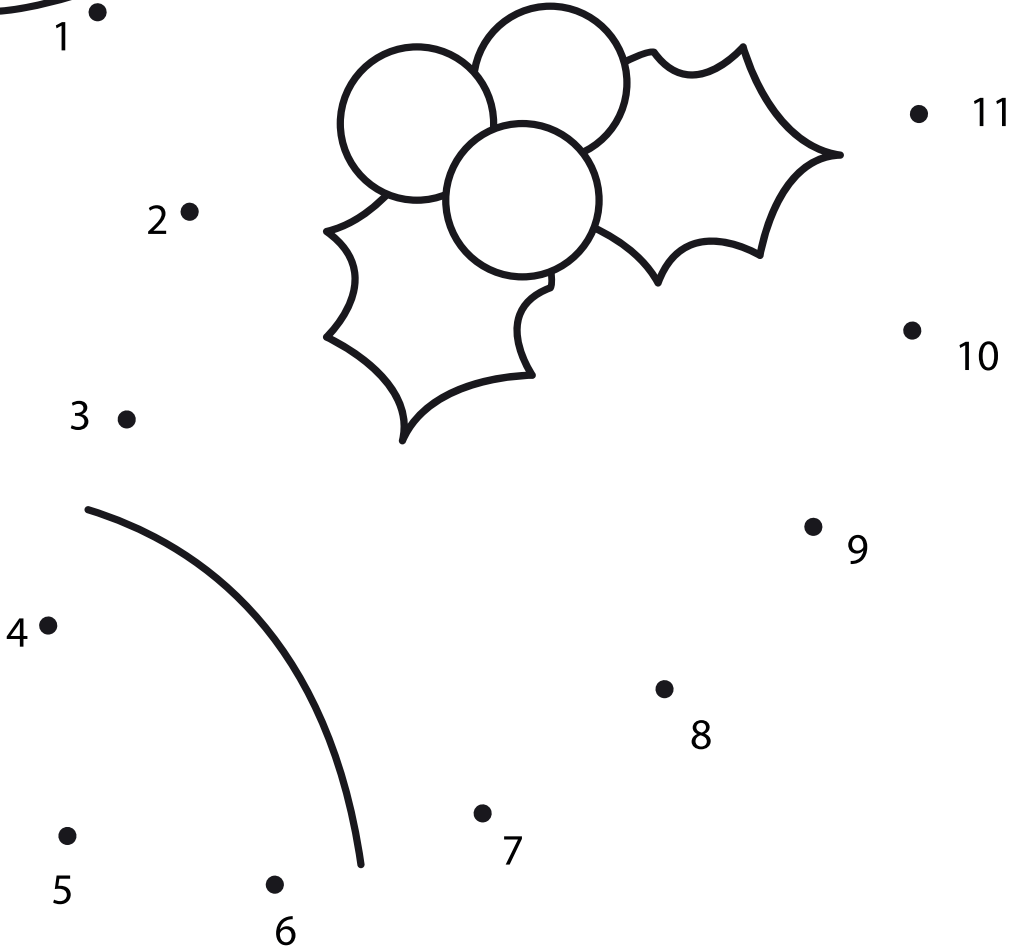
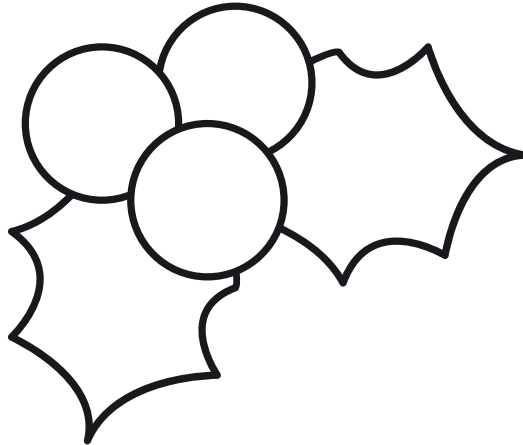
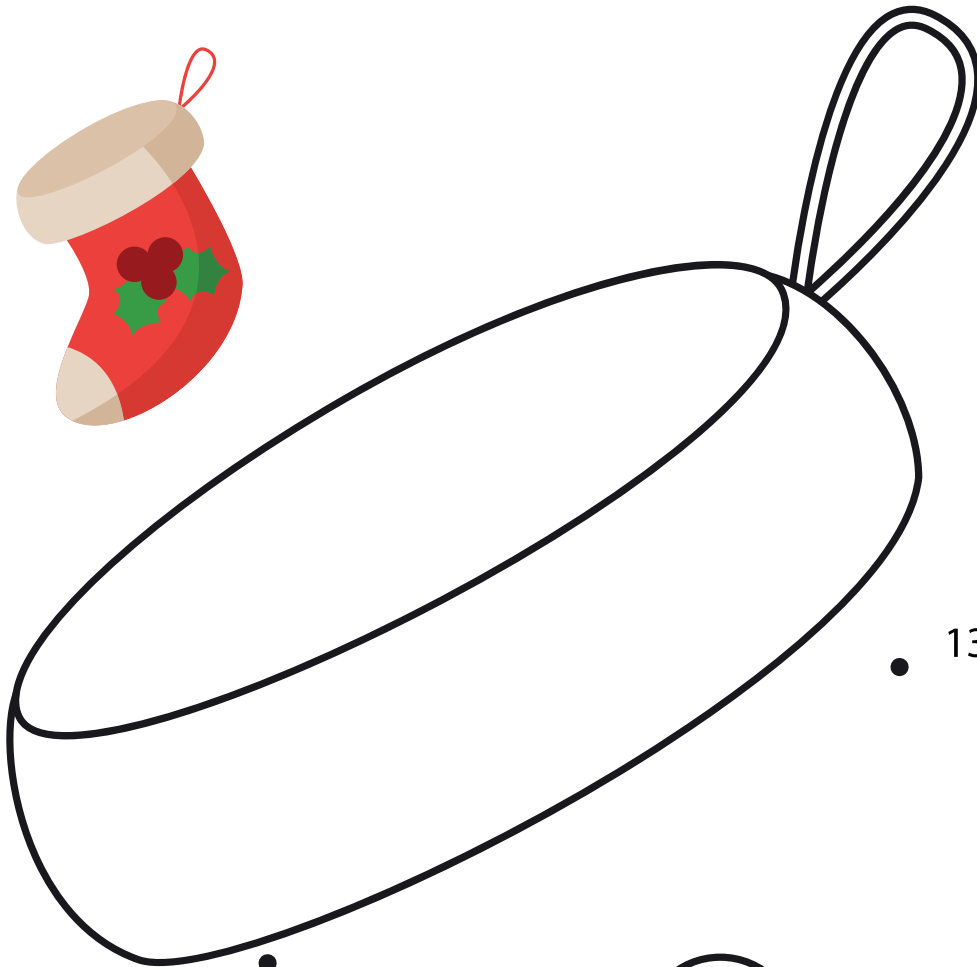

CONNECT THE DOTS

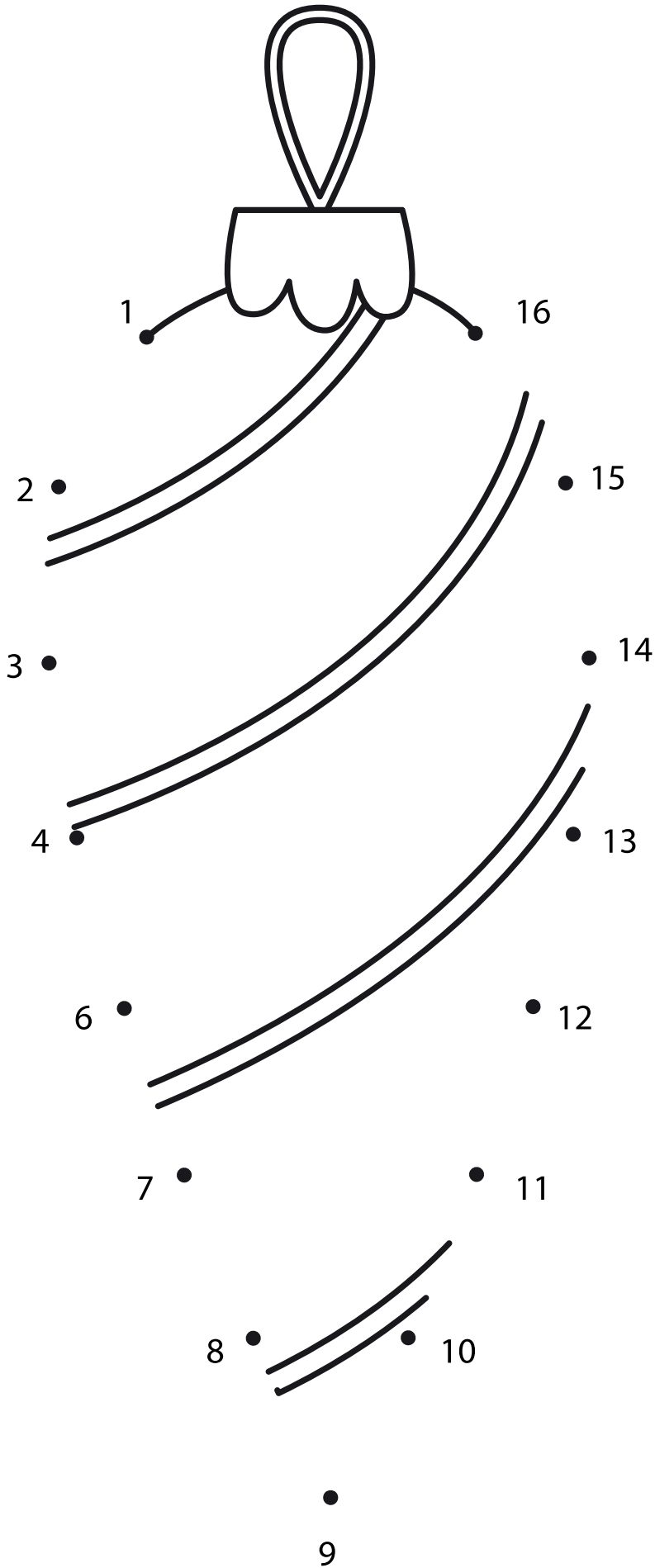
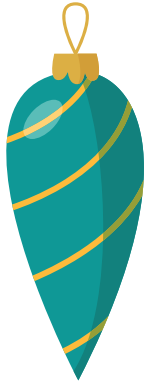

CONNECT THE DOTS

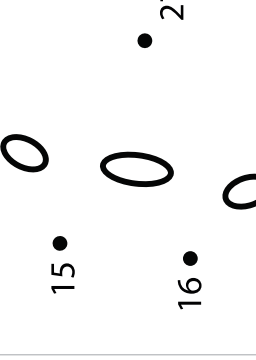
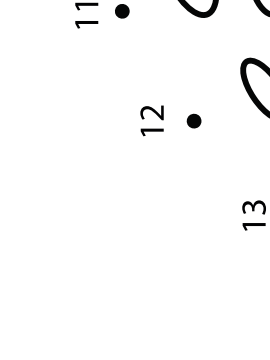
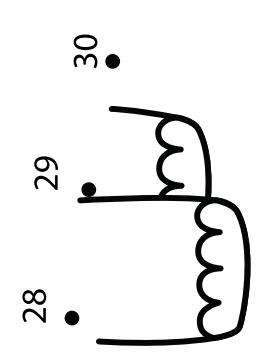
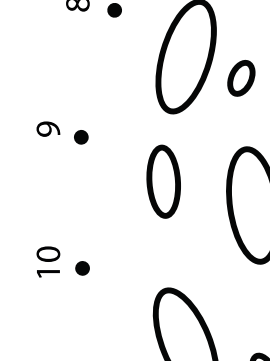
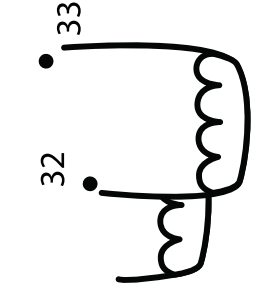
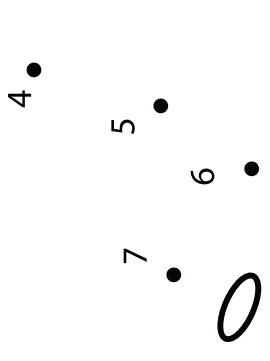
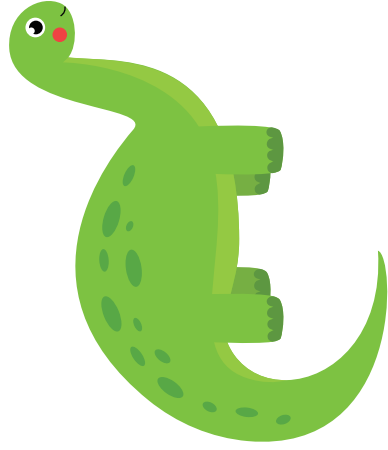
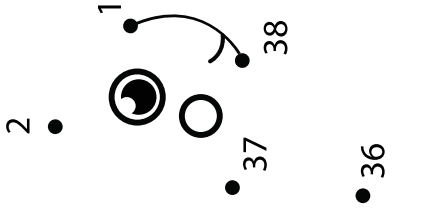

2

3

4

5

6

7

8

9

10

11

12

13

14

15

16

17

18

19

20

21

24

23

22

28

29

30

31

32

33

34

35

36

37

38

CONNECT THE DOTS

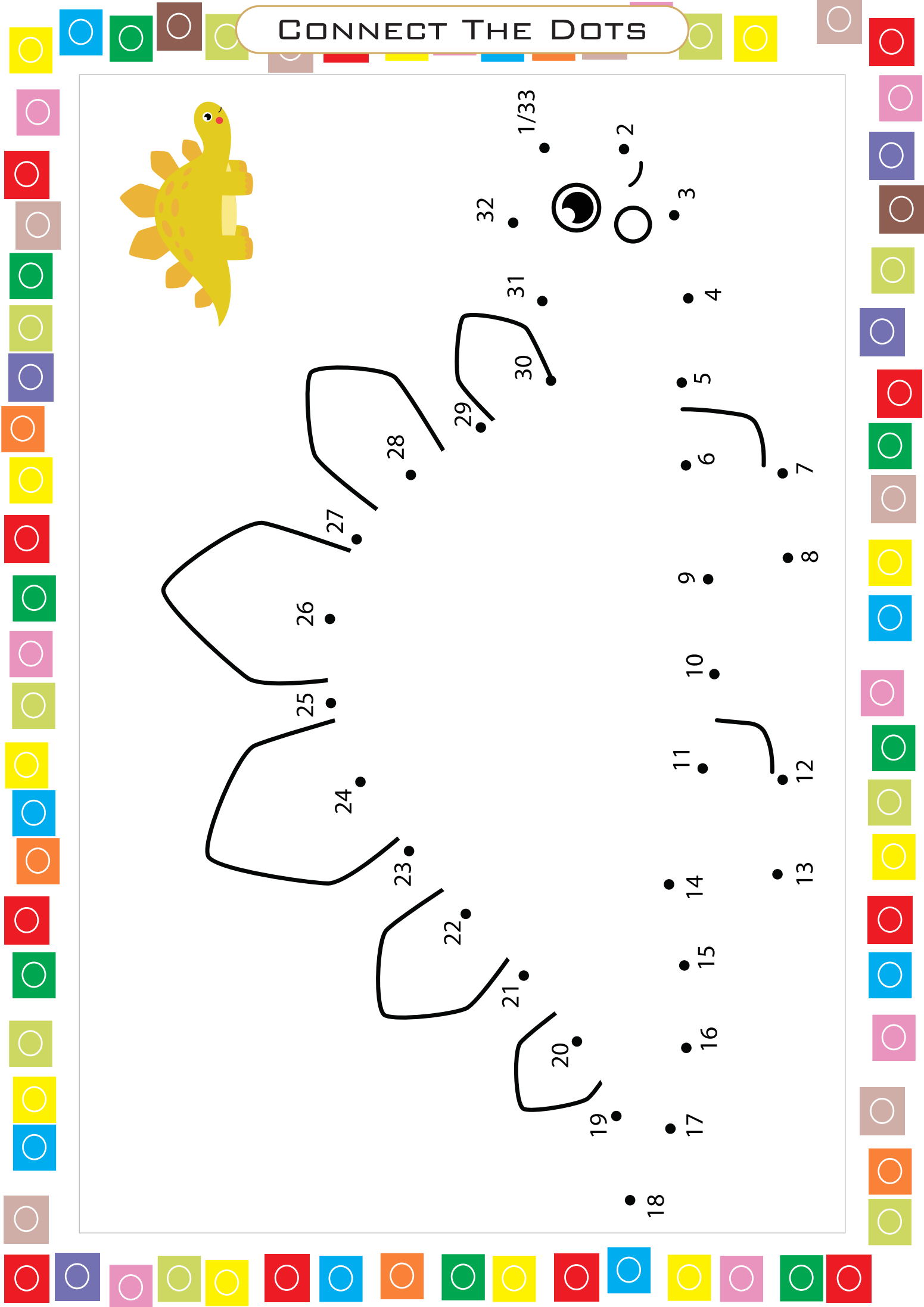
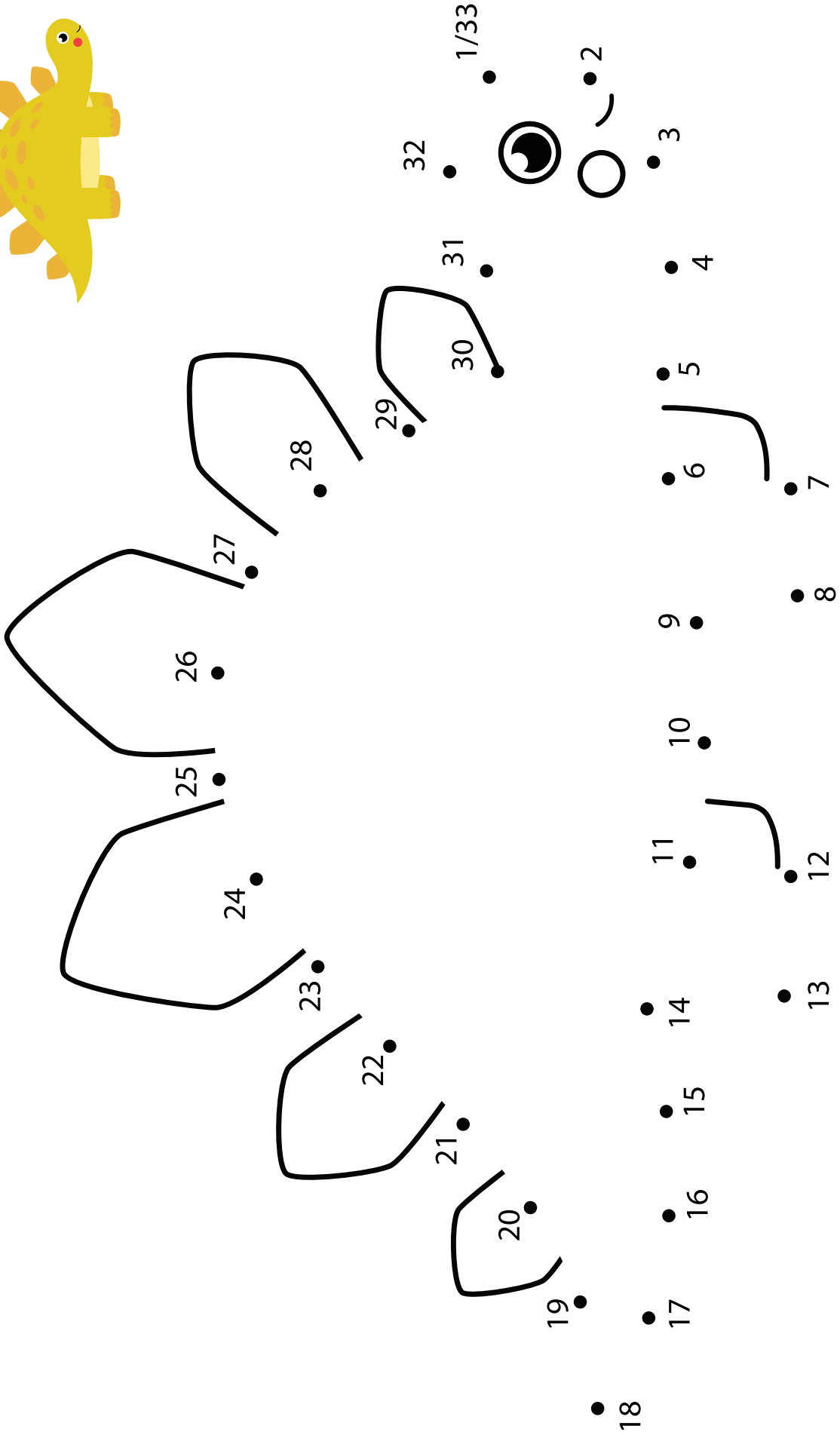
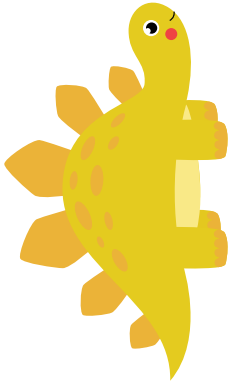

CONNECT THE DOTS

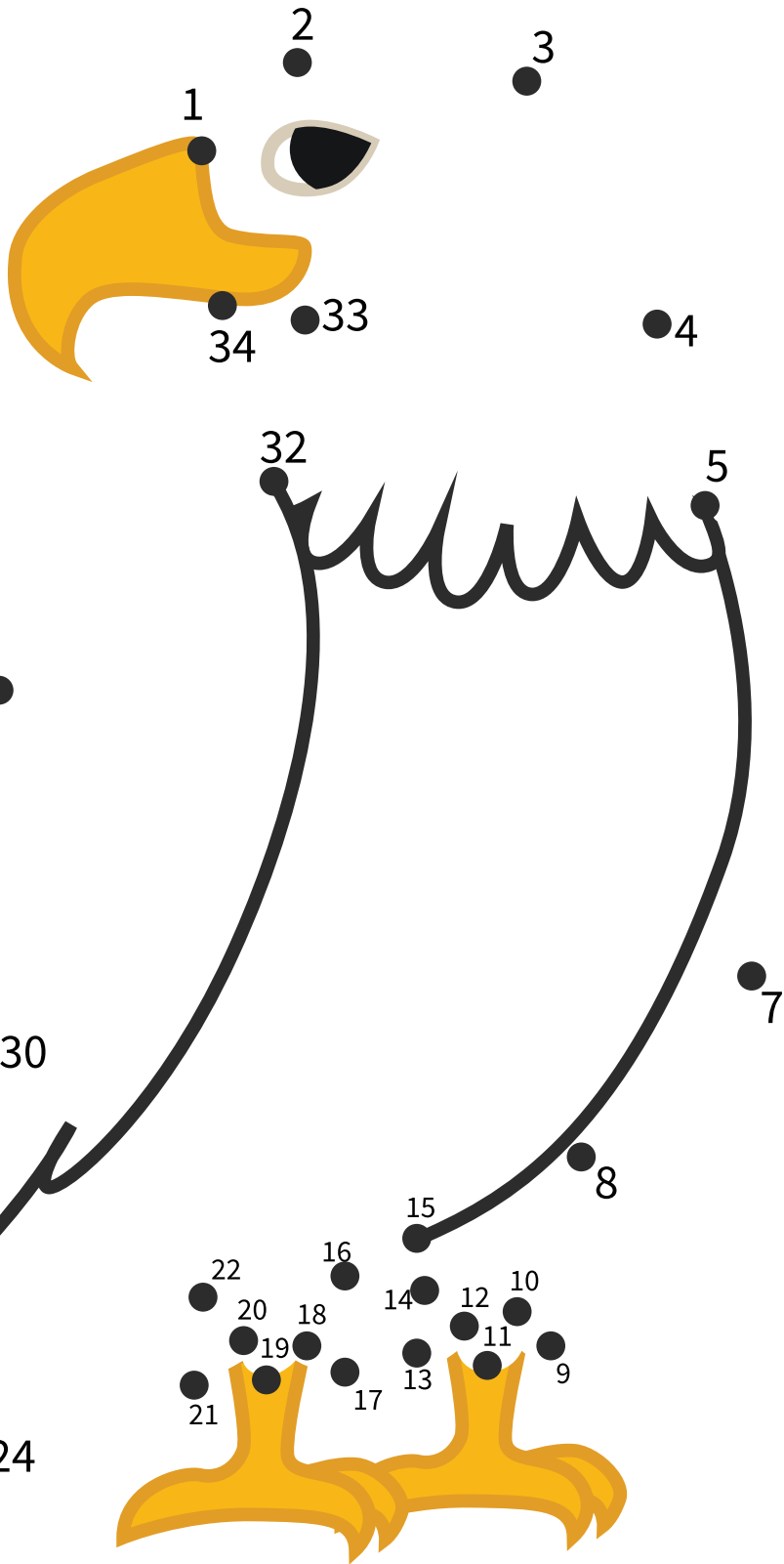

27●

25●

23●

29●

26●

28●

31●

30●

24●

1●

2●

3●

34●

32●

22●

21●

20●

19●

18●

16●

17●

14●

13●

12●

11●

10●

15●

4●

5●

6●

7●

8●

9●

33●

34●

CONNECT THE DOTS

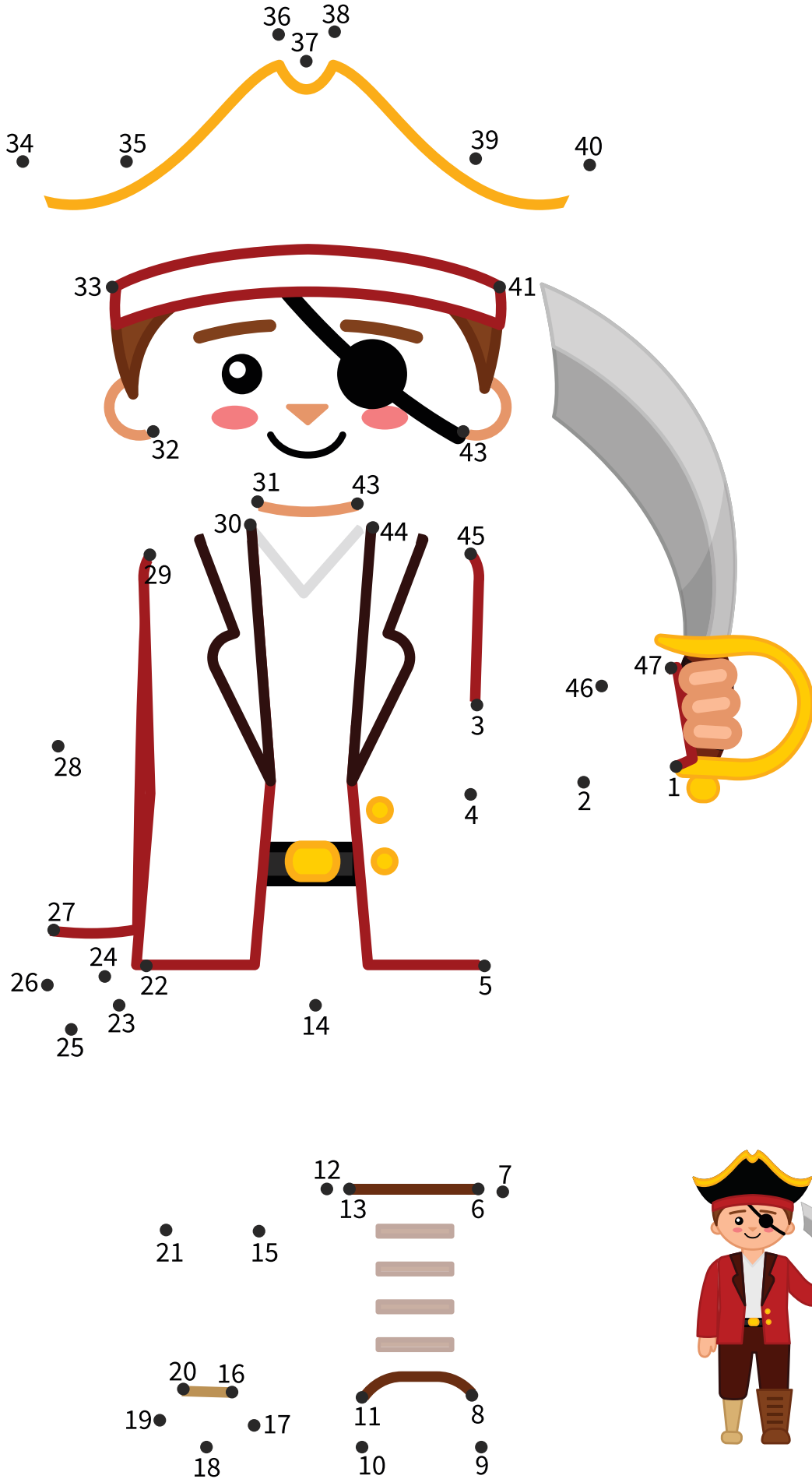

CONNECT THE DOTS



CONNECT THE DOTS



CONNECT THE DOTS

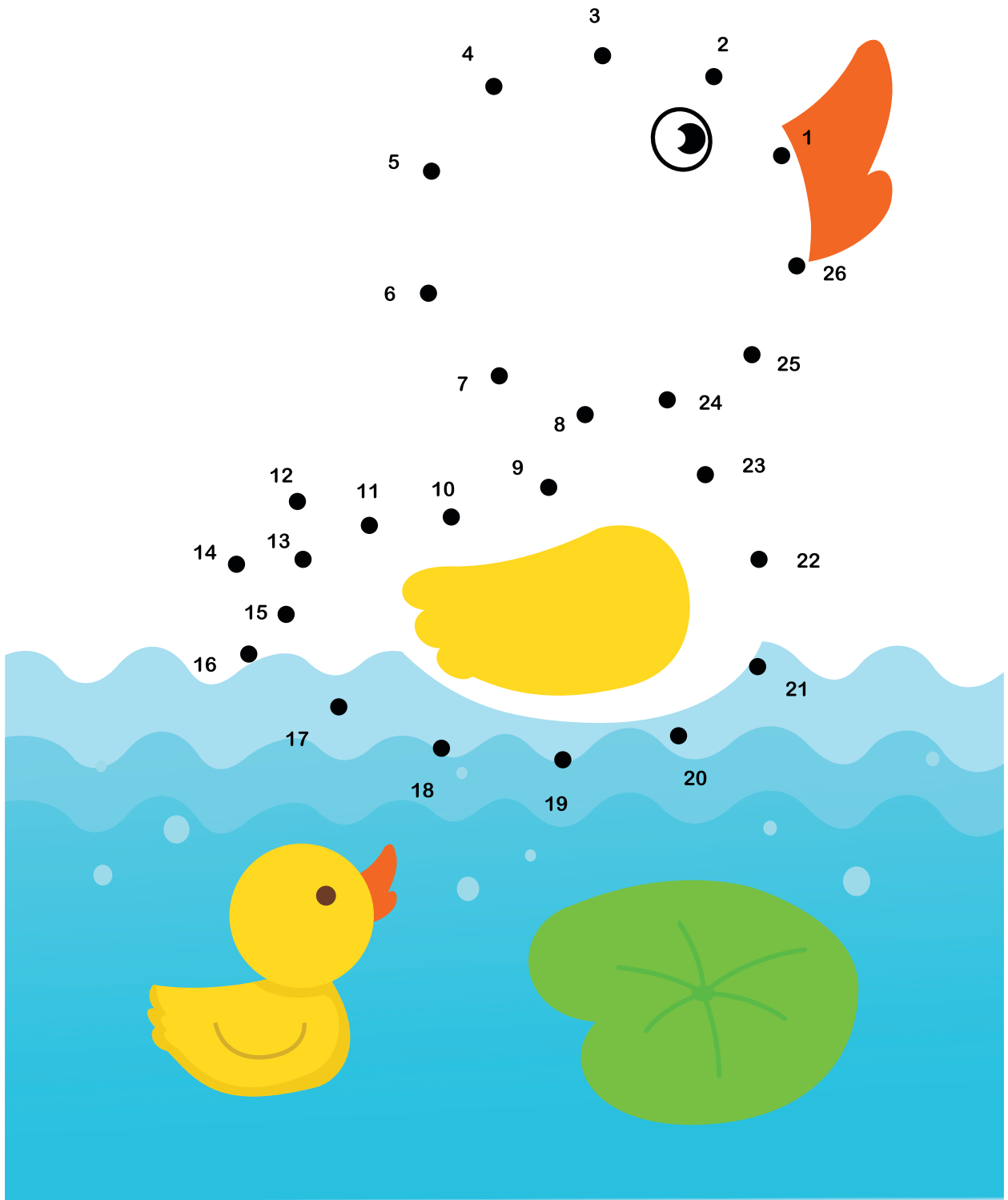

CONNECT THE DOTS

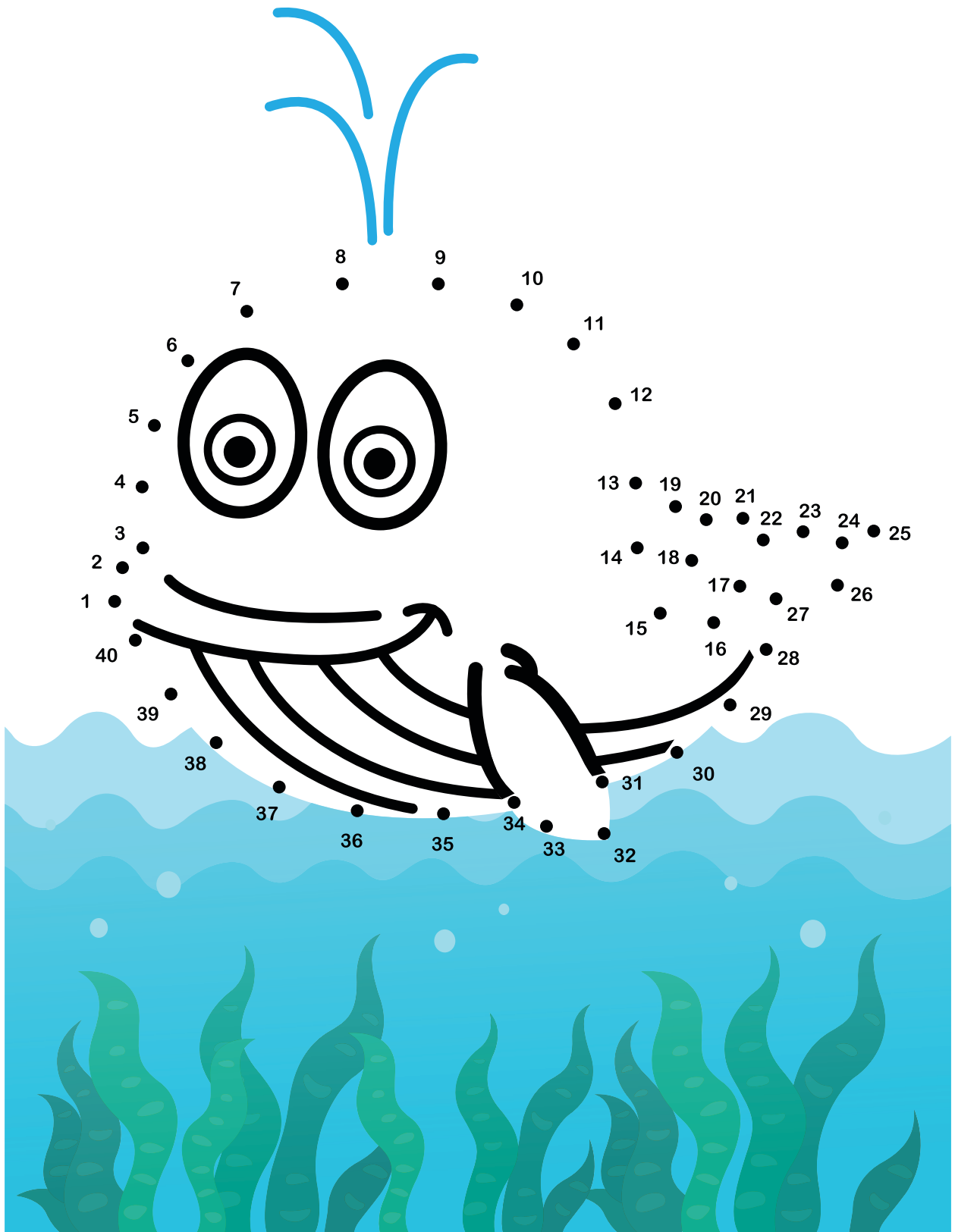

CONNECT THE DOTS

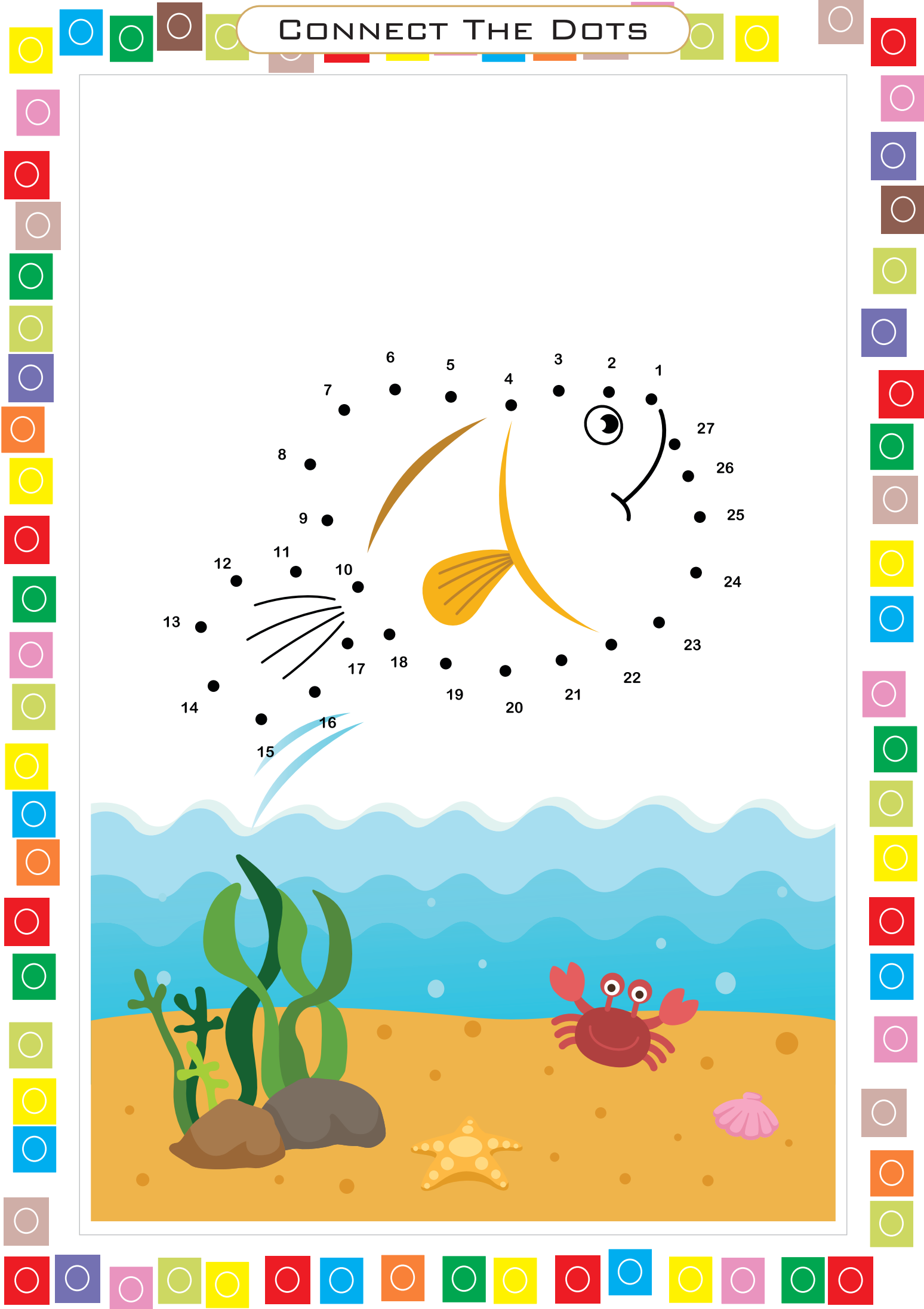
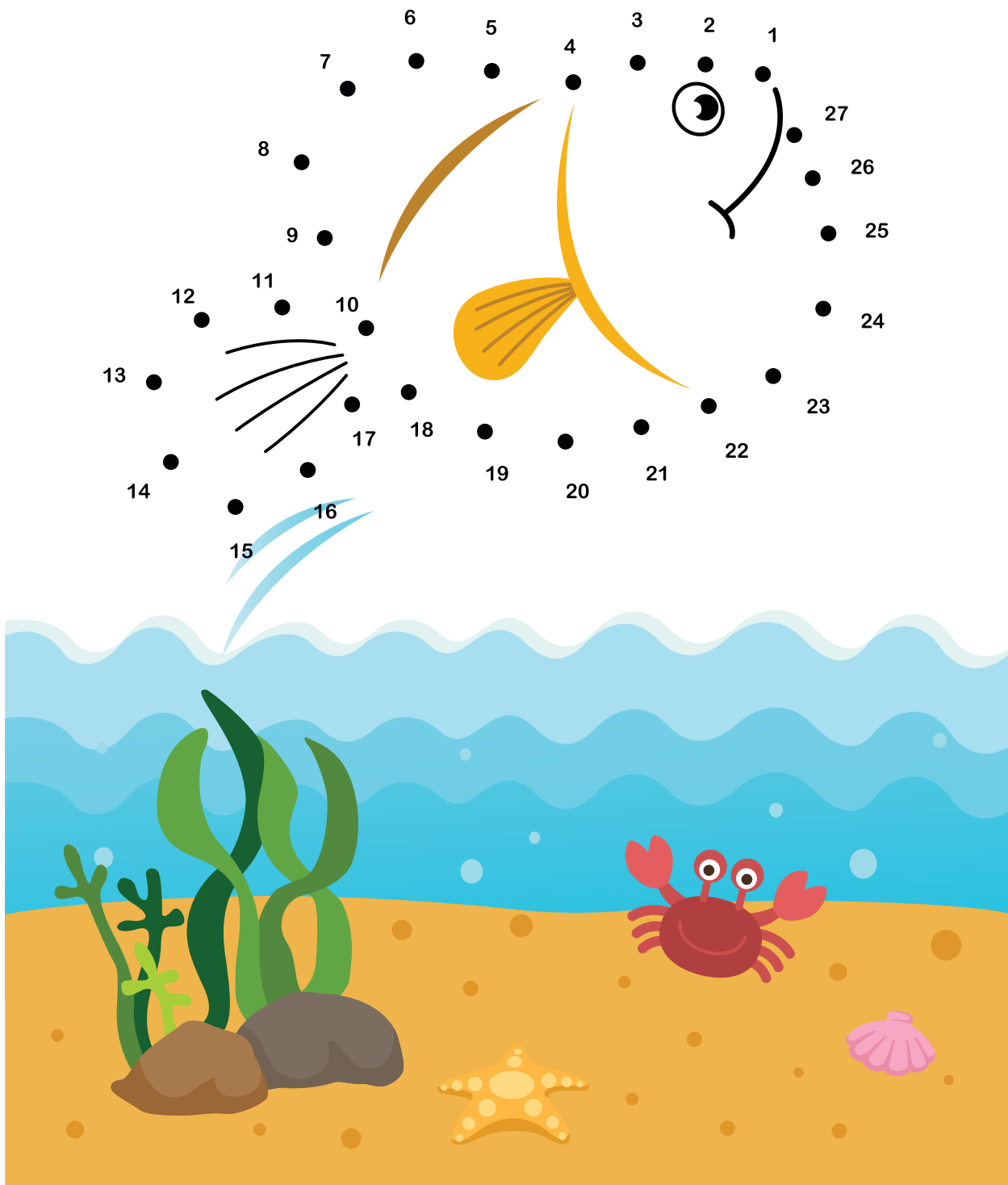

CONNECT THE DOTS



CONNECT THE DOTS

