



Alphabet A to Z Coloring and Tracing Worksheet Set



Name: _____ Date: _____

Directions: Color the drawing and trace the word.

Alphabet A

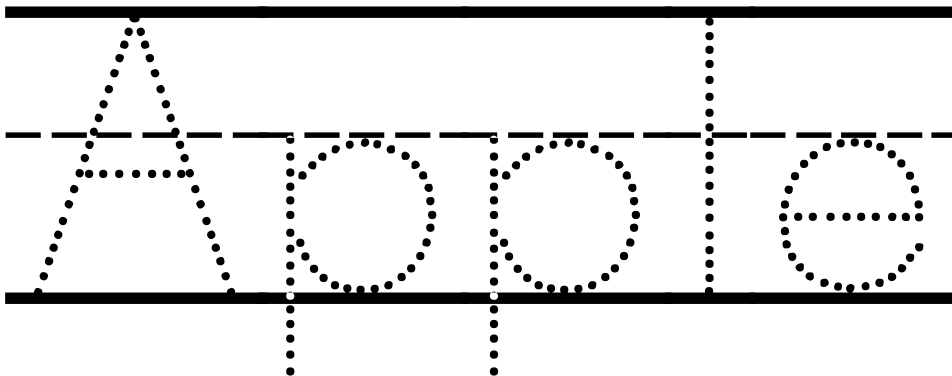
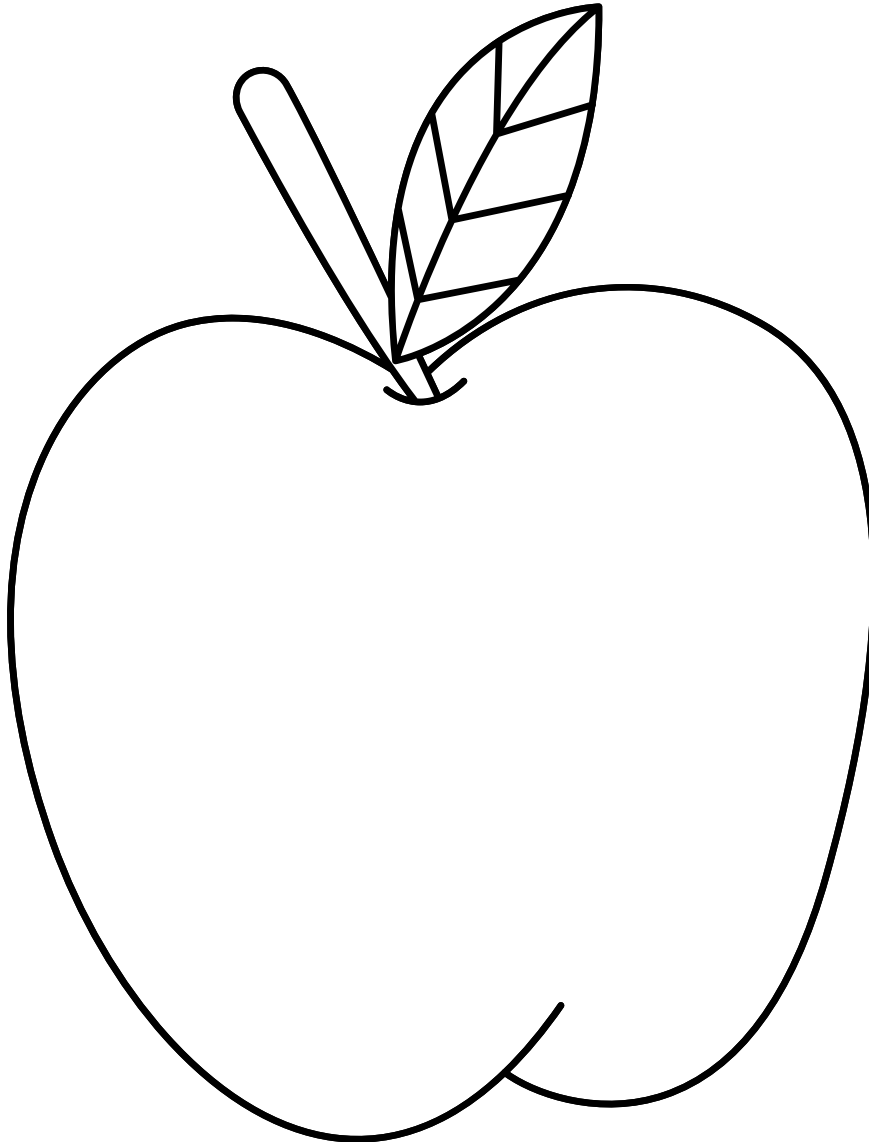

Name: _____

Date: _____

Directions: Color the drawing and trace the word.

Alphabet B

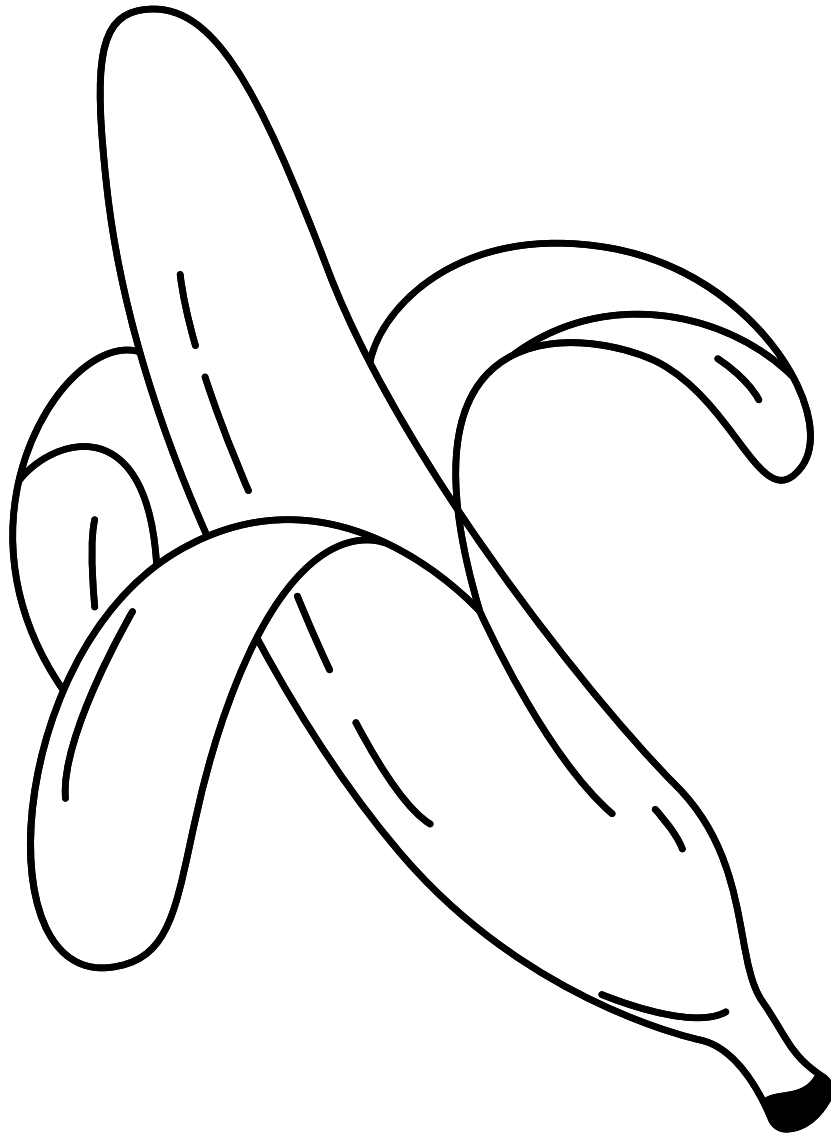

Name: _____

Date: _____

Directions: Color the drawing and trace the word.

Alphabet C

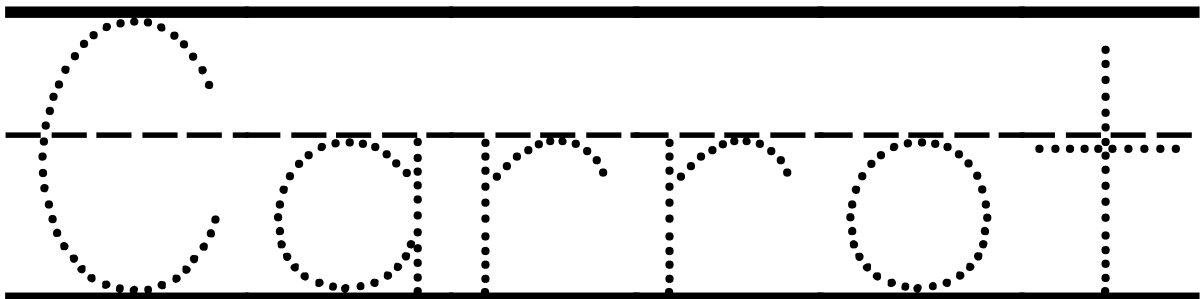
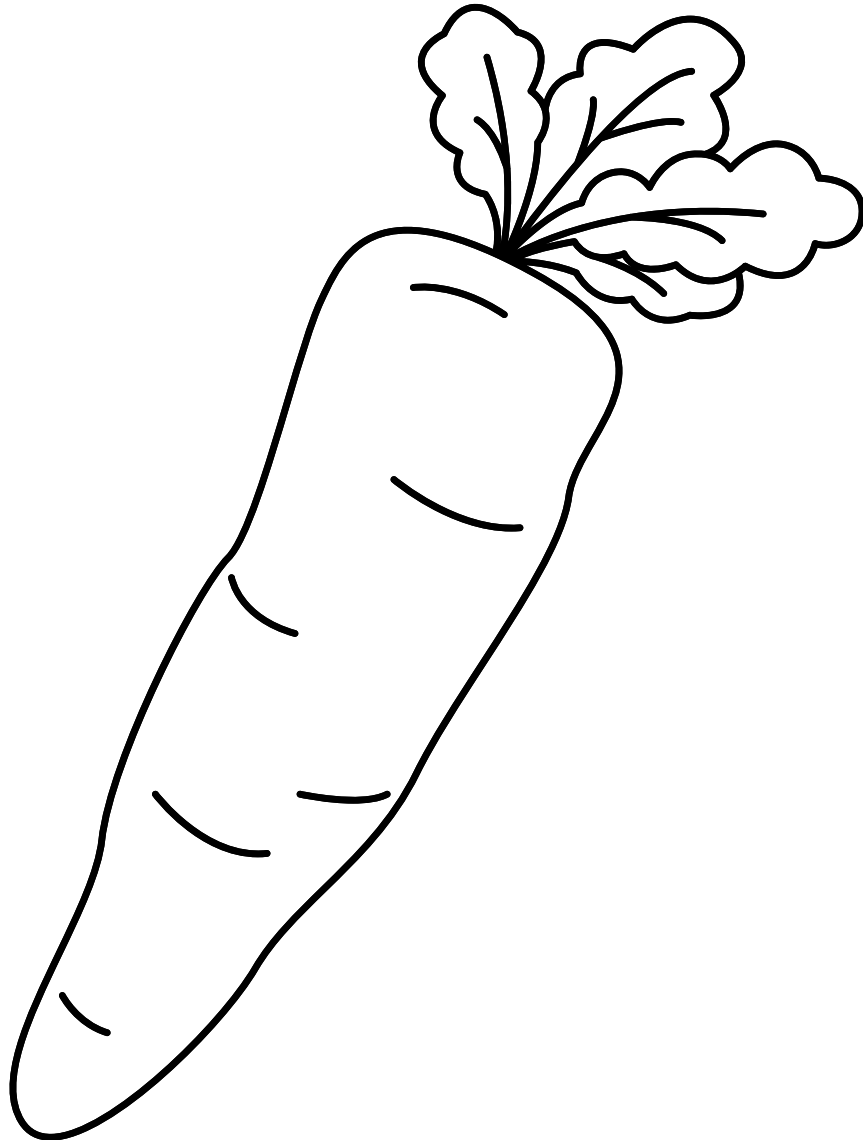

Name: _____

Date: _____

Directions: Color the drawing and trace the word.

Alphabet D

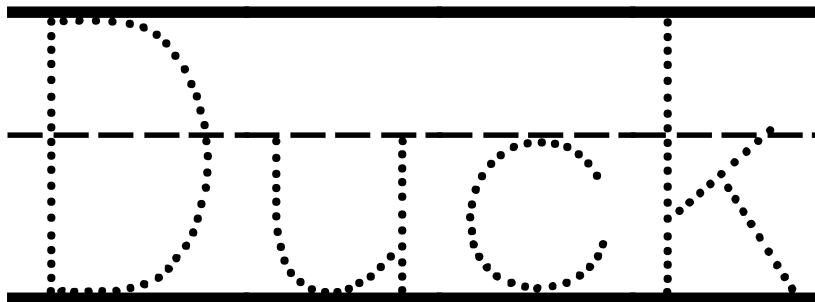
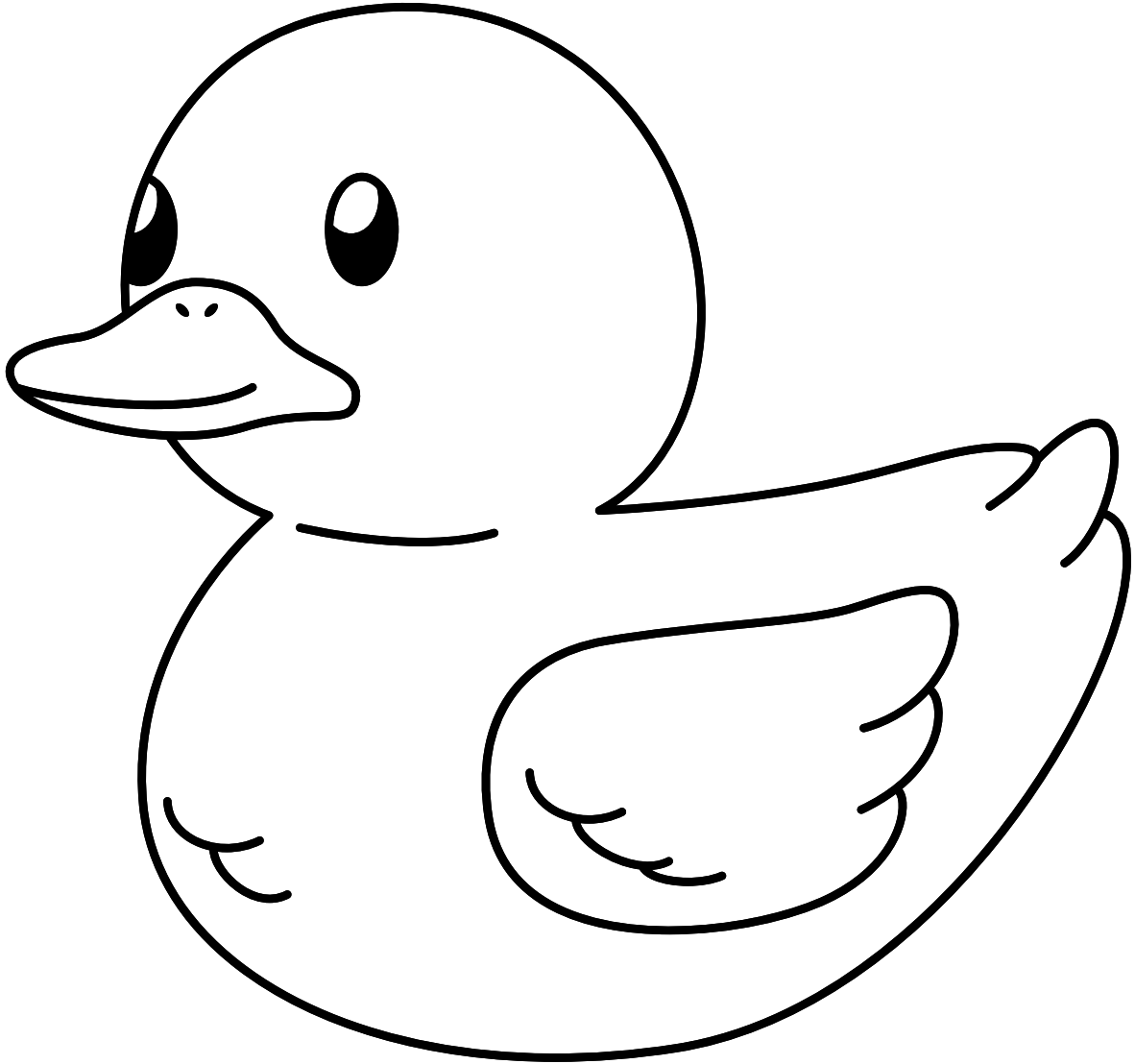

Name: _____

Date: _____

Directions: Color the drawing and trace the word.

Alphabet E

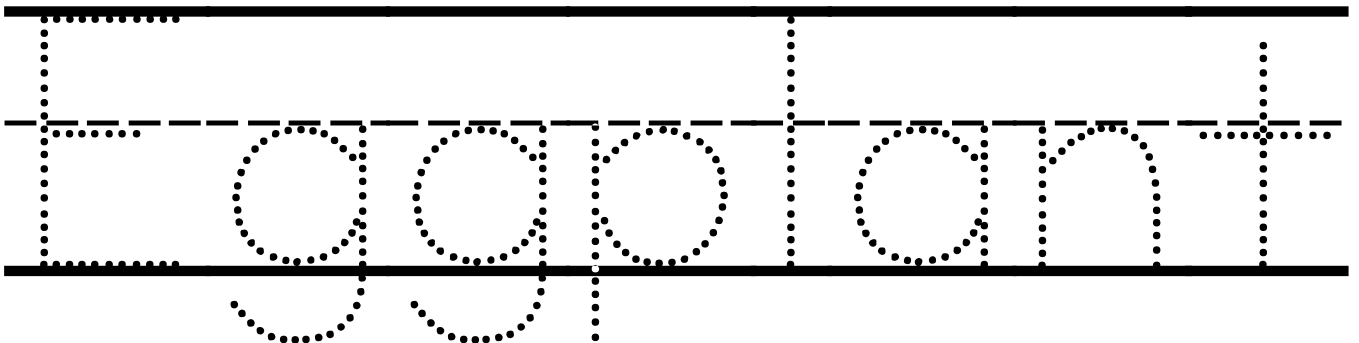
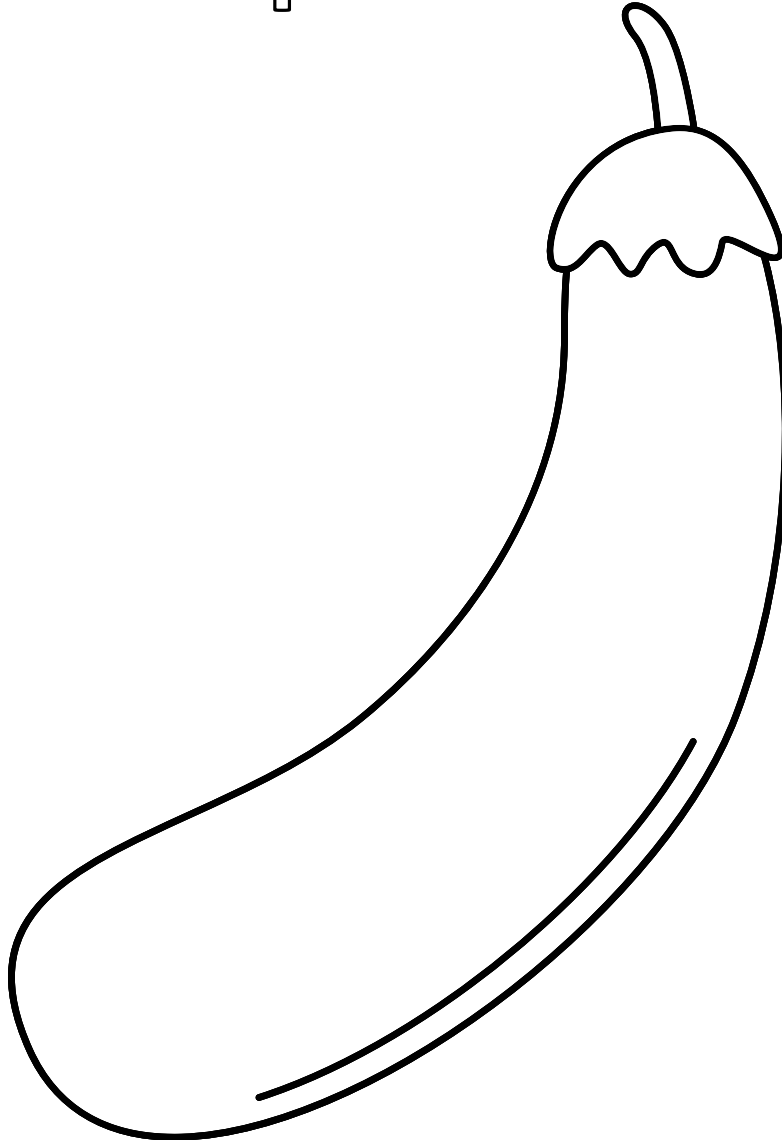

Name: _____

Date: _____

Directions: Color the drawing and trace the word.

Alphabet F

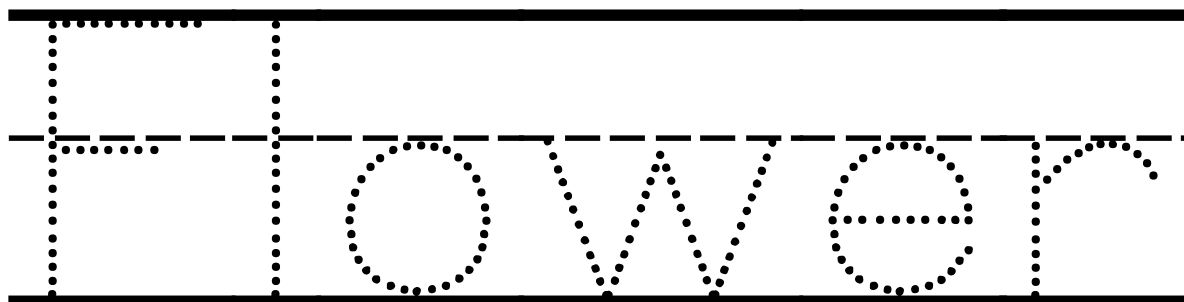
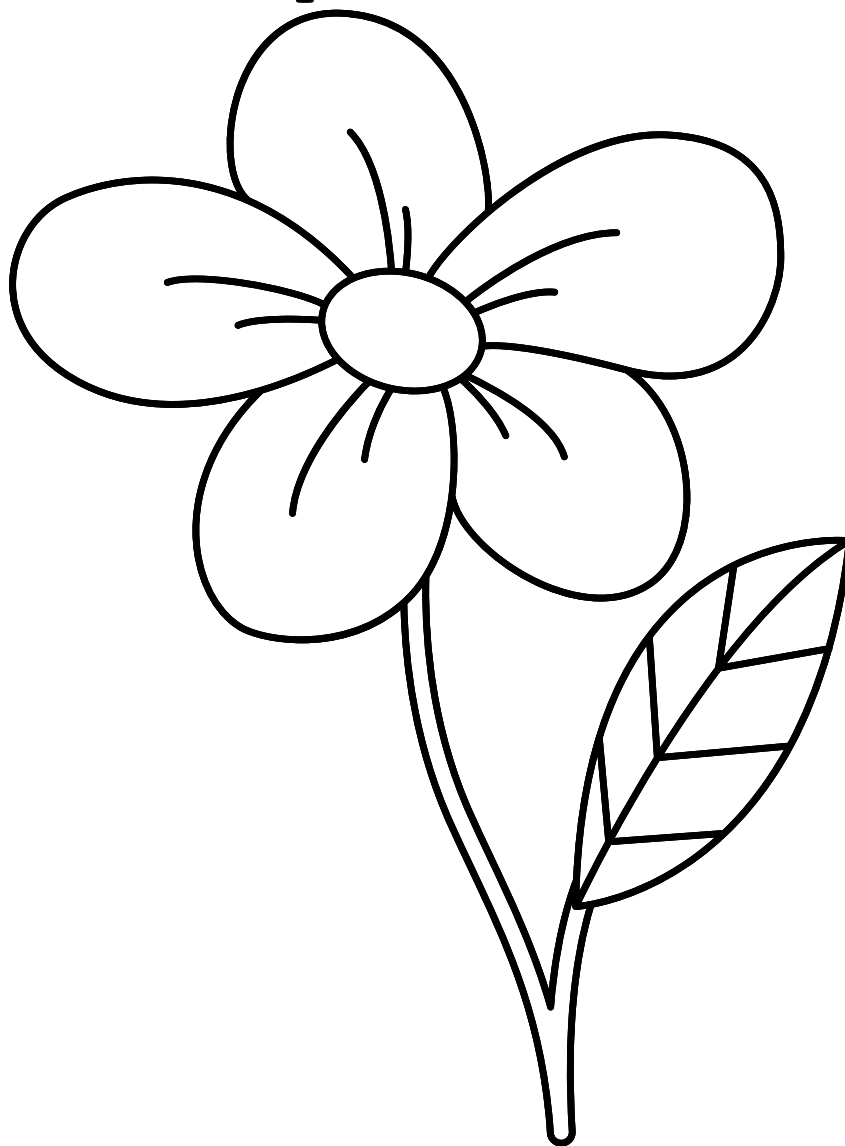

Name: _____

Date: _____

Directions: Color the drawing and trace the word.

Alphabet G

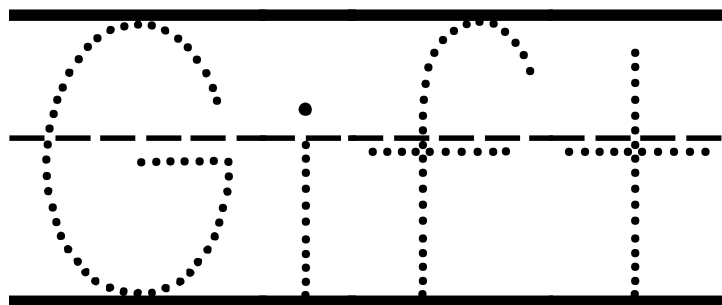
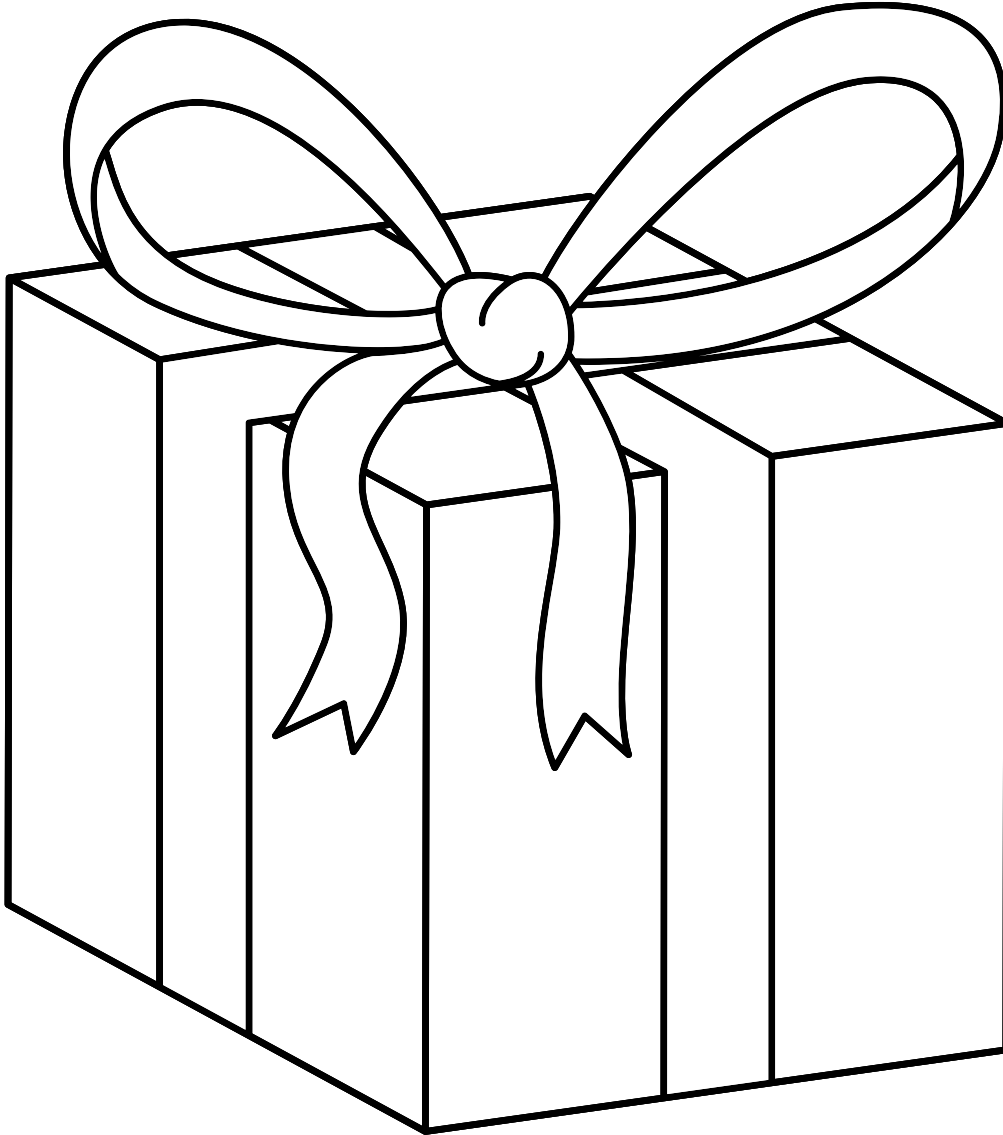

Name: _____

Date: _____

Directions: Color the drawing and trace the word.

Alphabet H

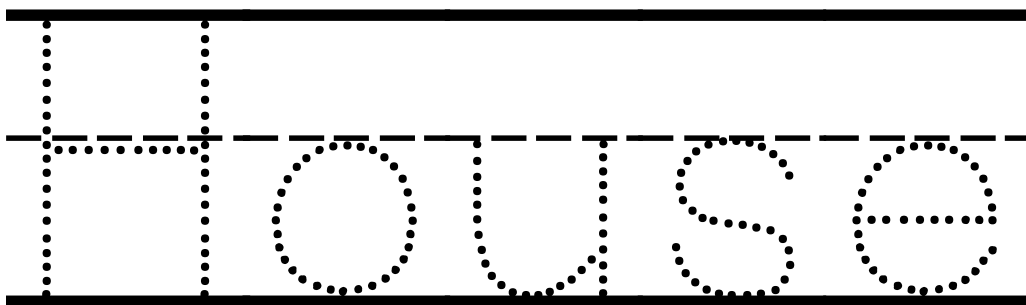
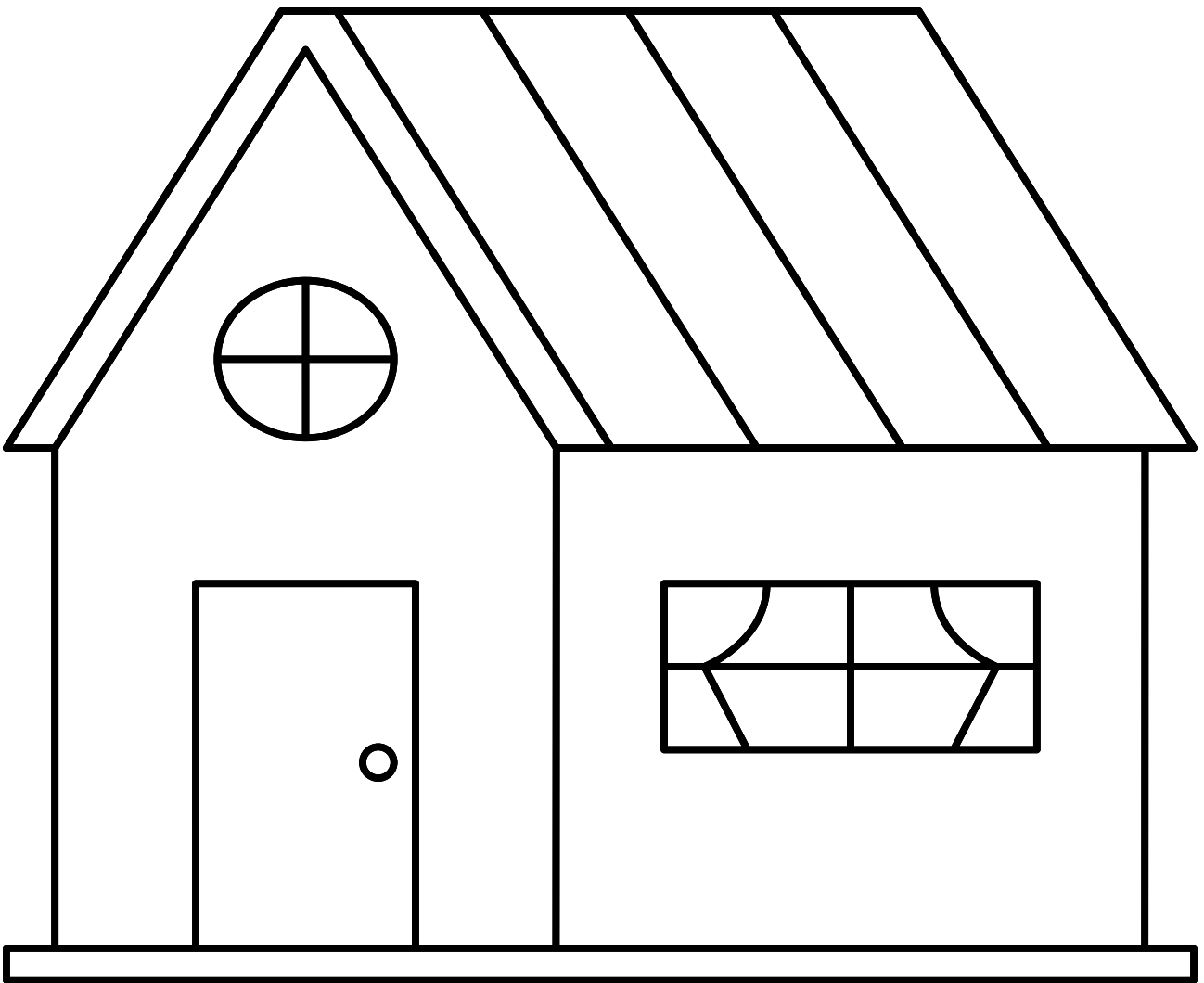

Name: _____

Date: _____

Directions: Color the drawing and trace the word.

Alphabet I

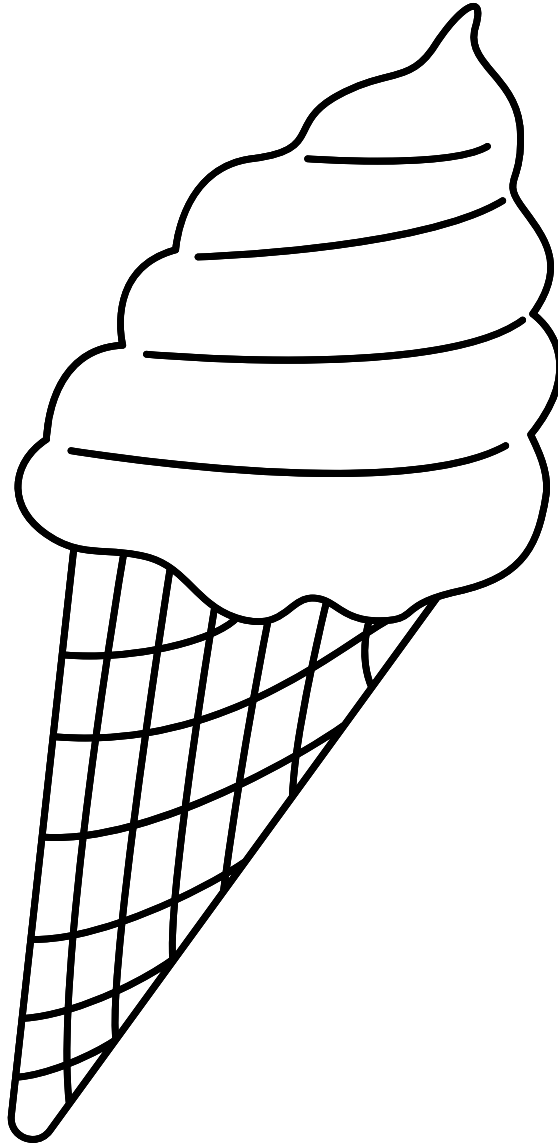

Ice Cream

Name: _____ Date: _____

Directions: Color the drawing and trace the word.

Alphabet J

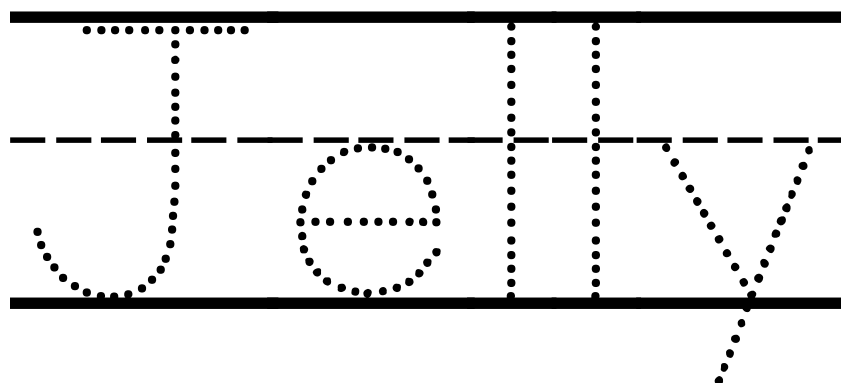
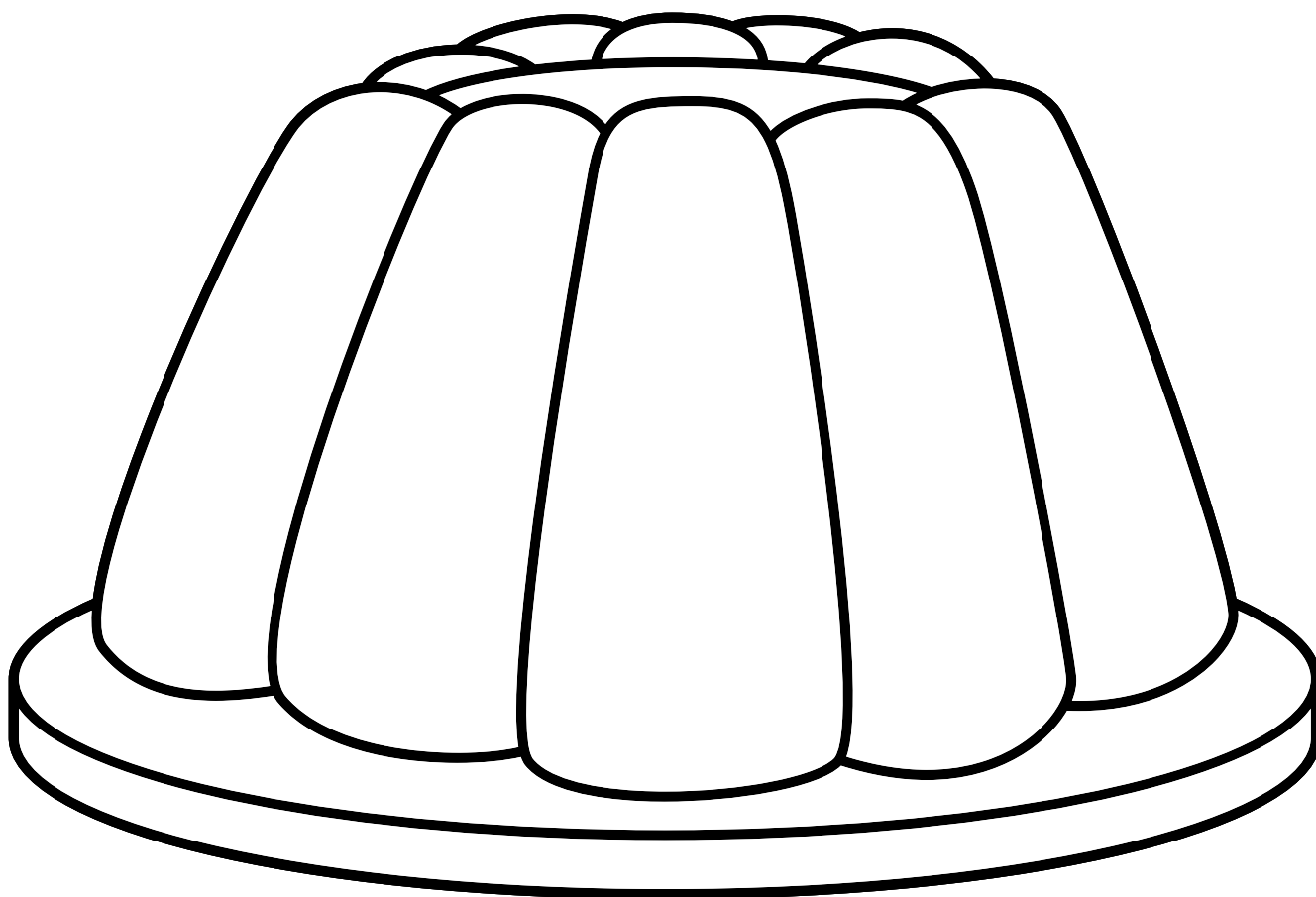



Name: _____

Date: _____

Directions: Color the drawing and trace the word.

Alphabet K

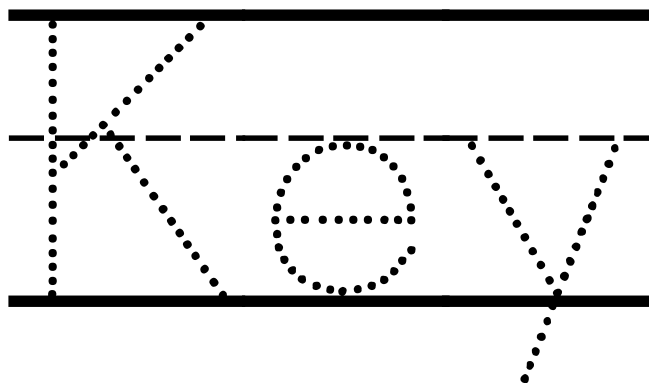
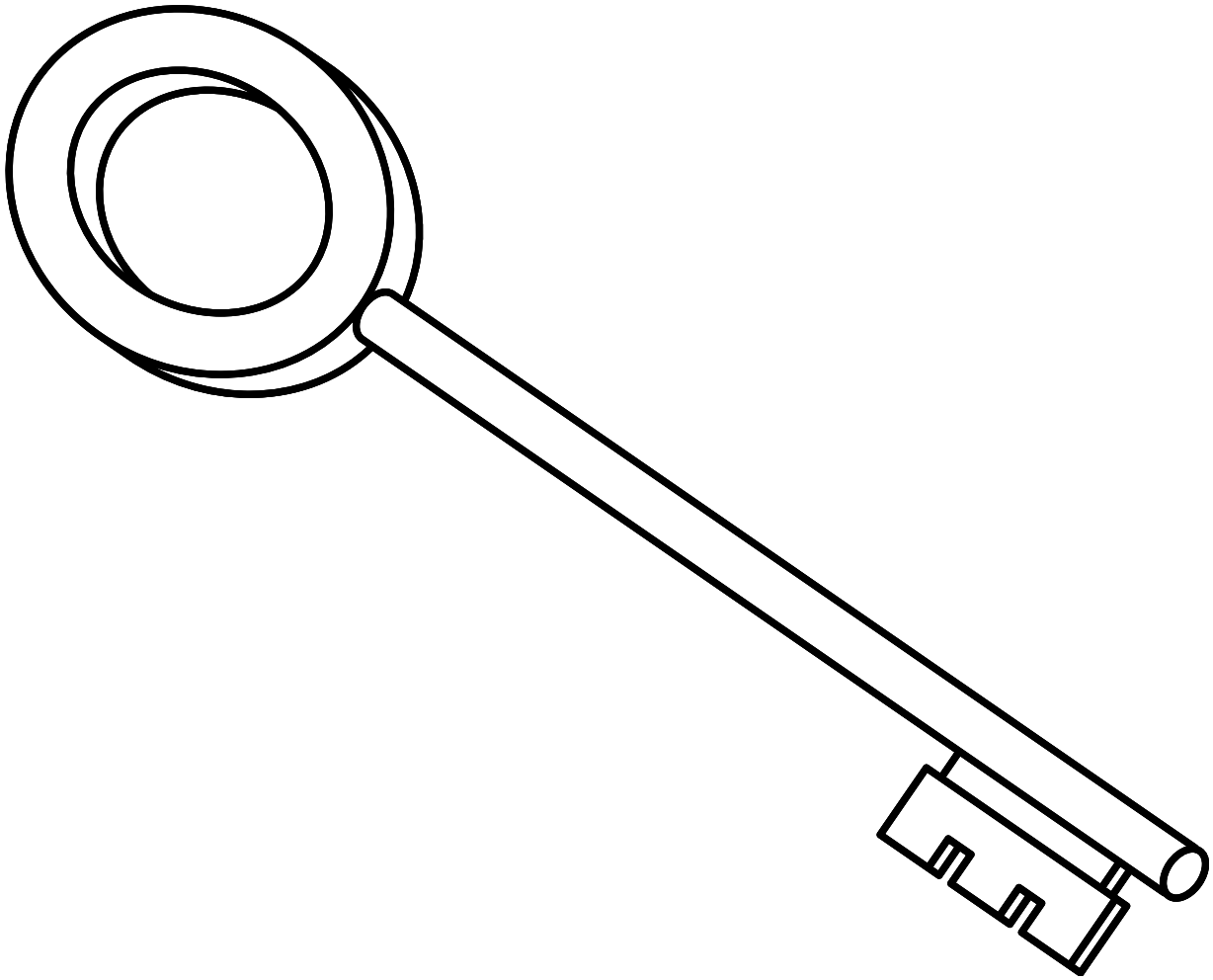

Name: _____

Date: _____

Directions: Color the drawing and trace the word.

Alphabet L

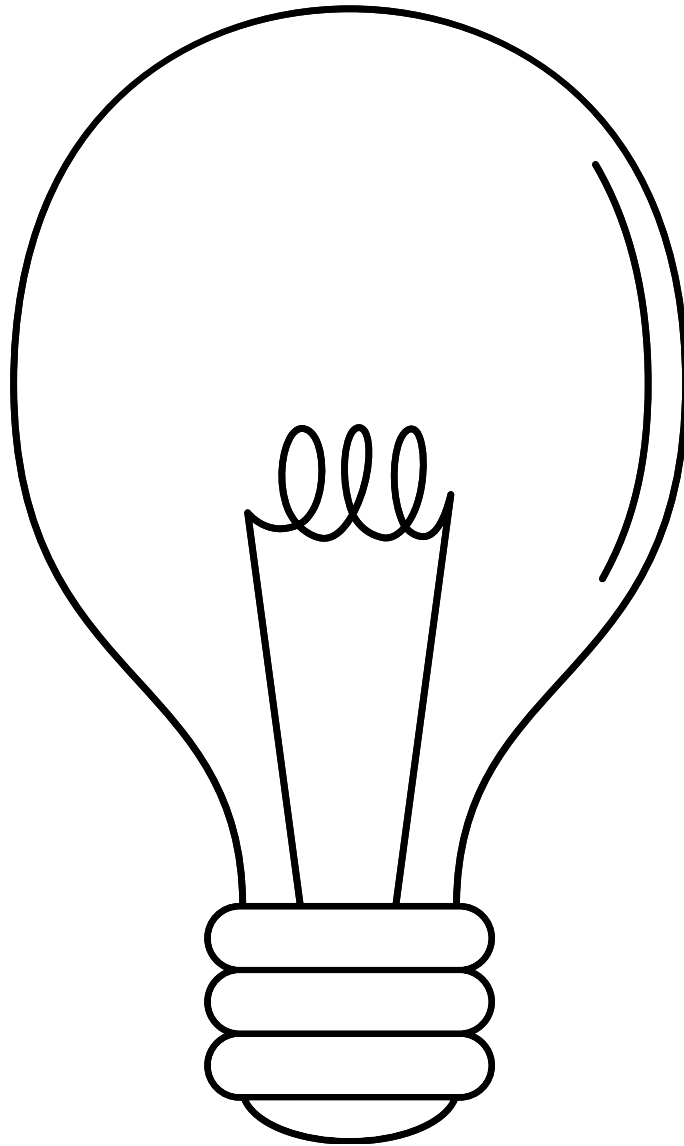

Light Bulb

Name: _____

Date: _____

Directions: Color the drawing and trace the word.

Alphabet M

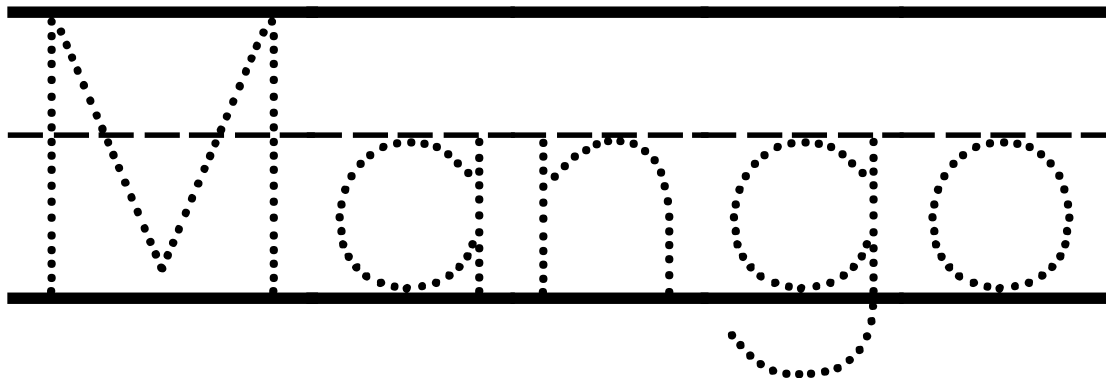
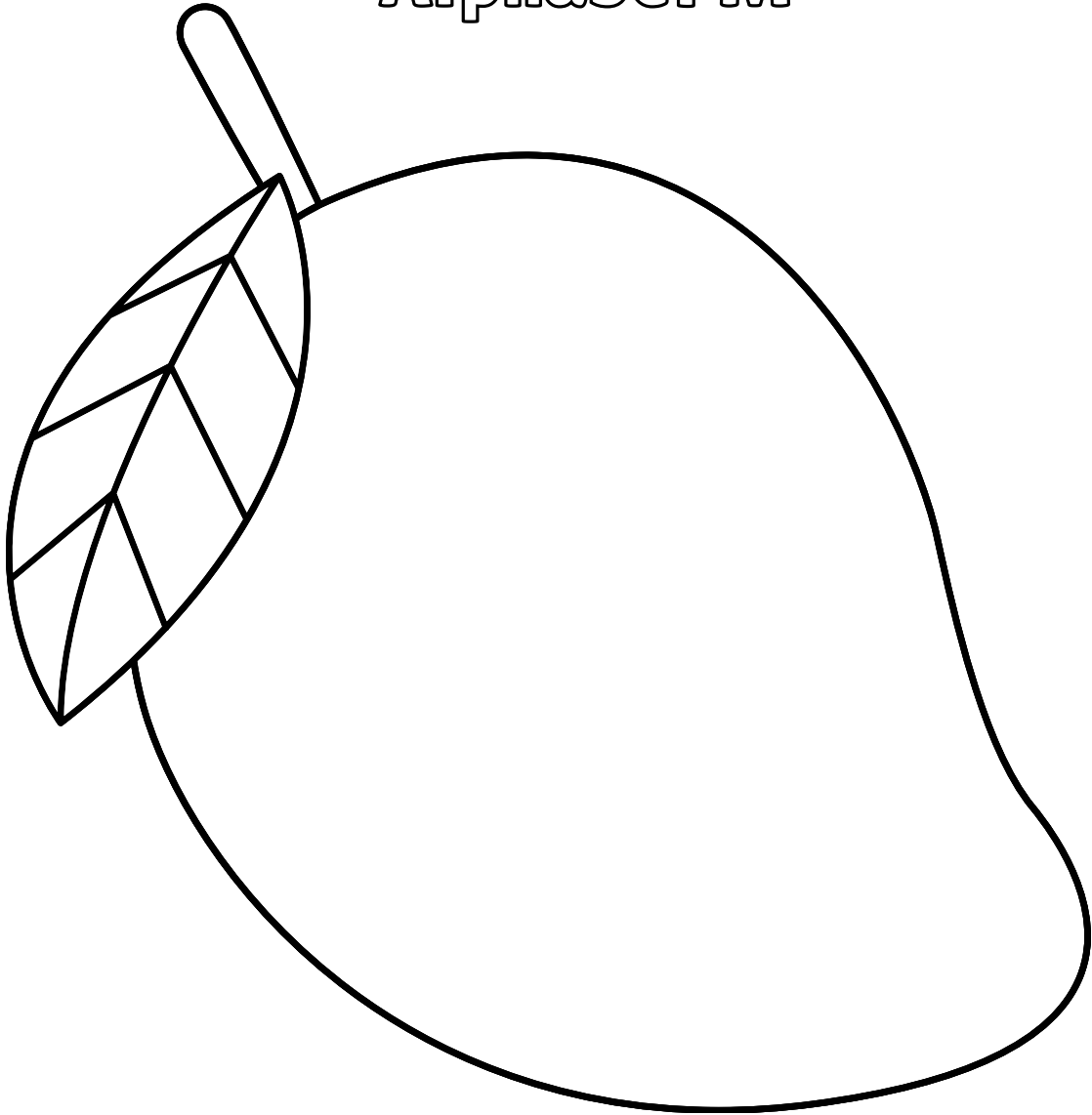



Name: _____

Date: _____

Directions: Color the drawing and trace the word.

Alphabet N

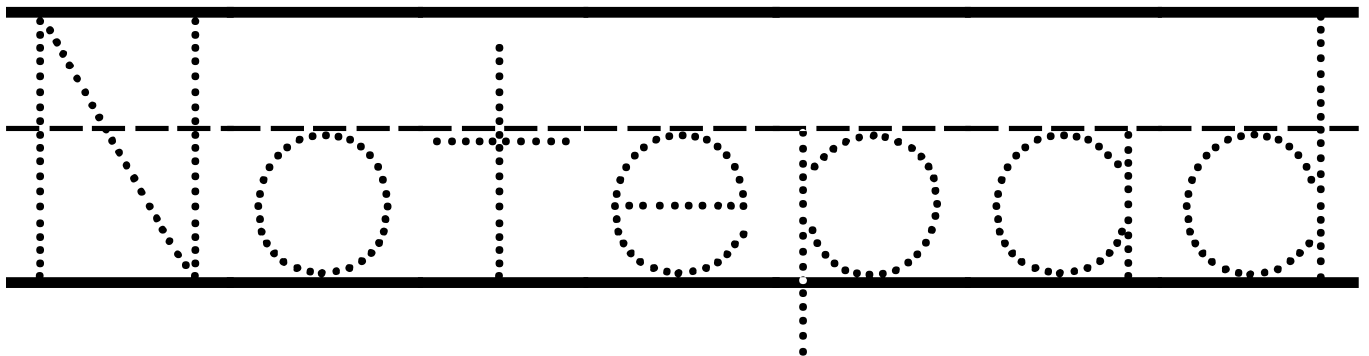
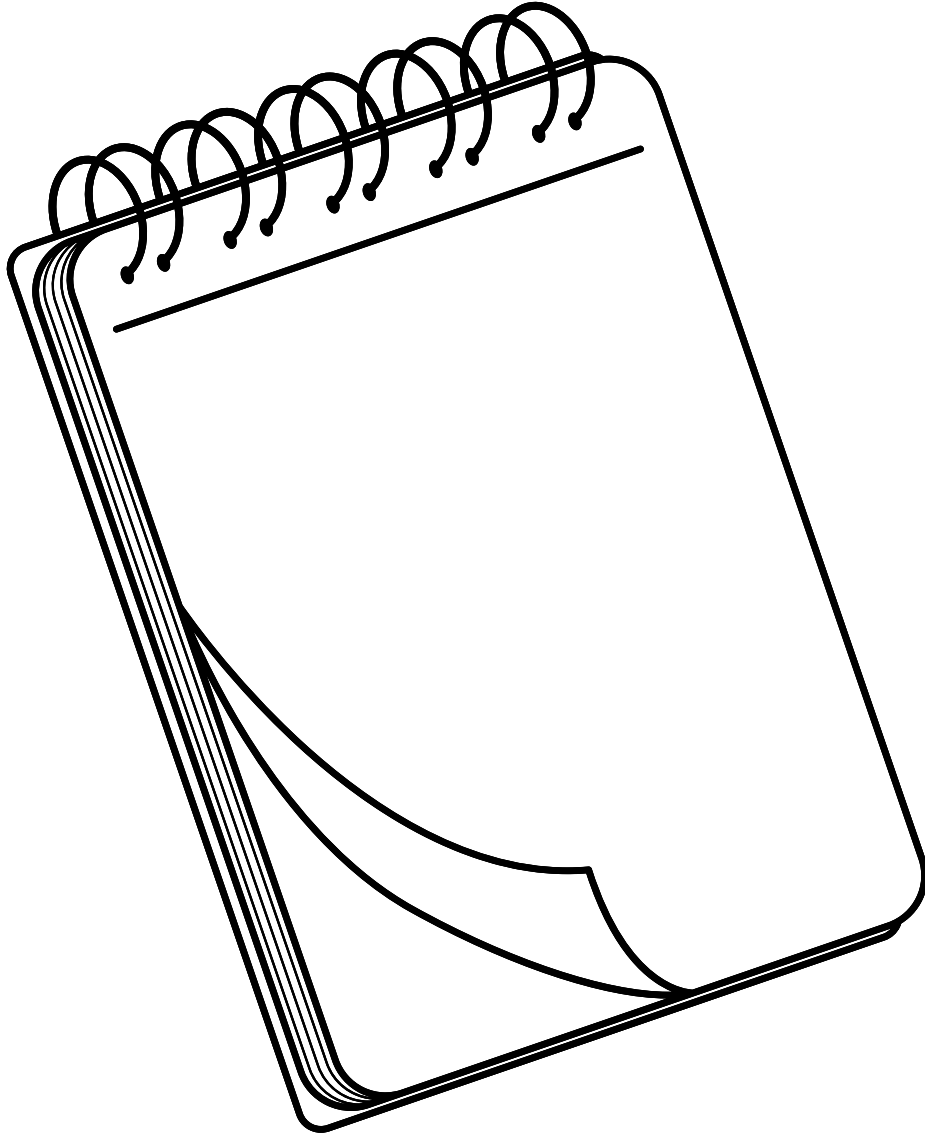

Name: _____

Date: _____

Directions: Color the drawing and trace the word.

Alphabet O

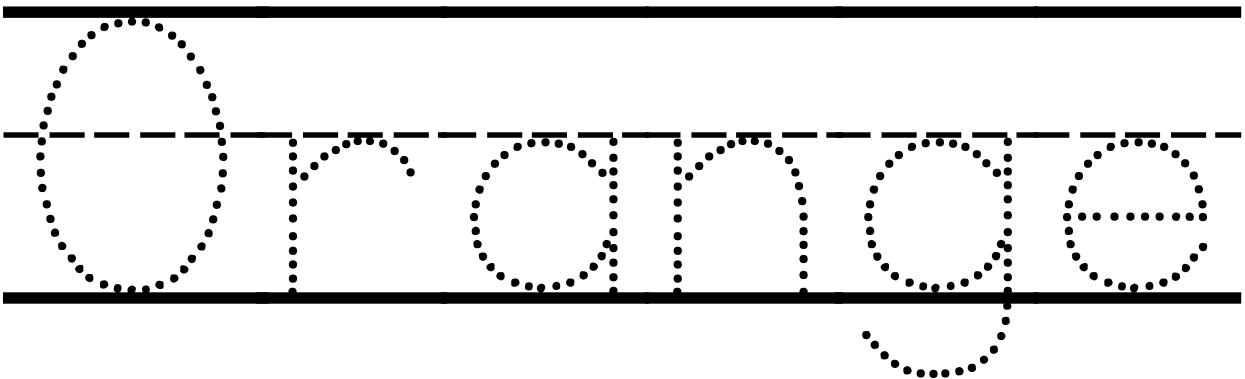
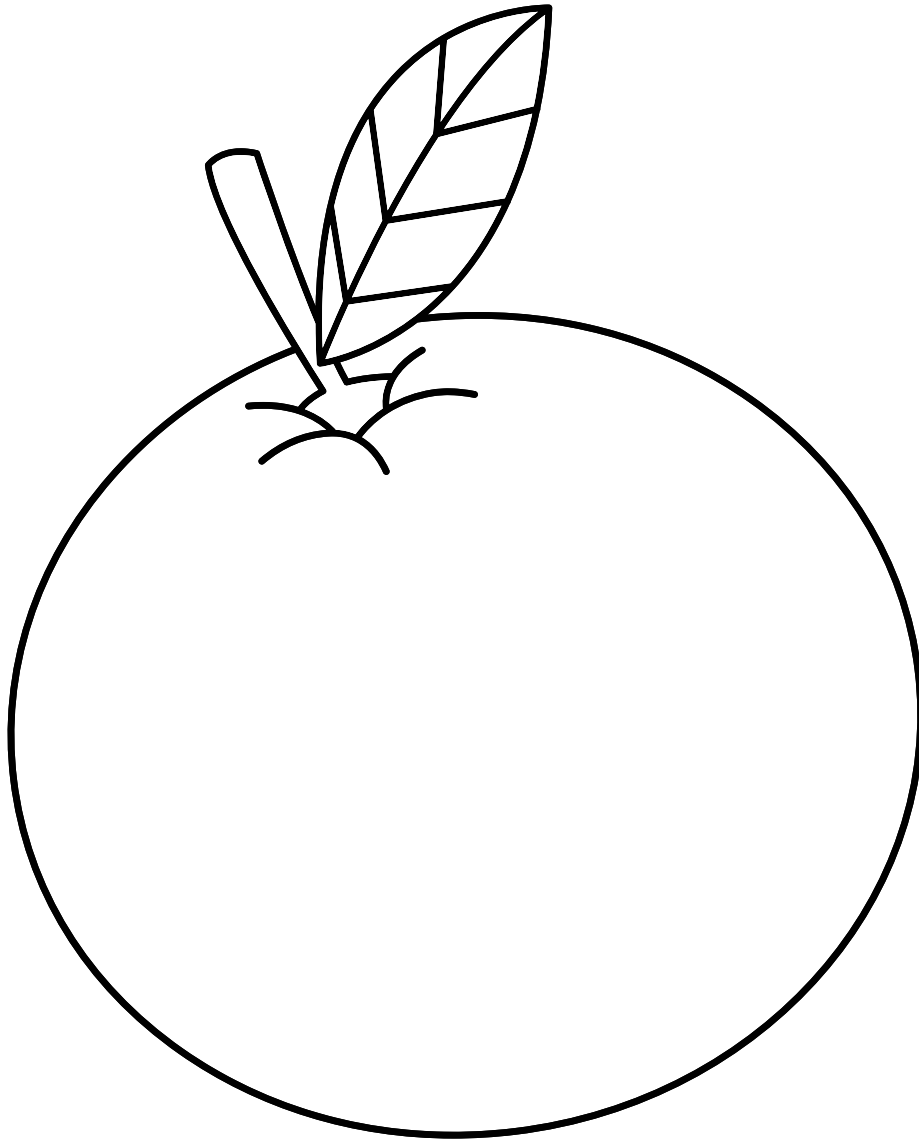

Name: _____

Date: _____

Directions: Color the drawing and trace the word.

Alphabet P

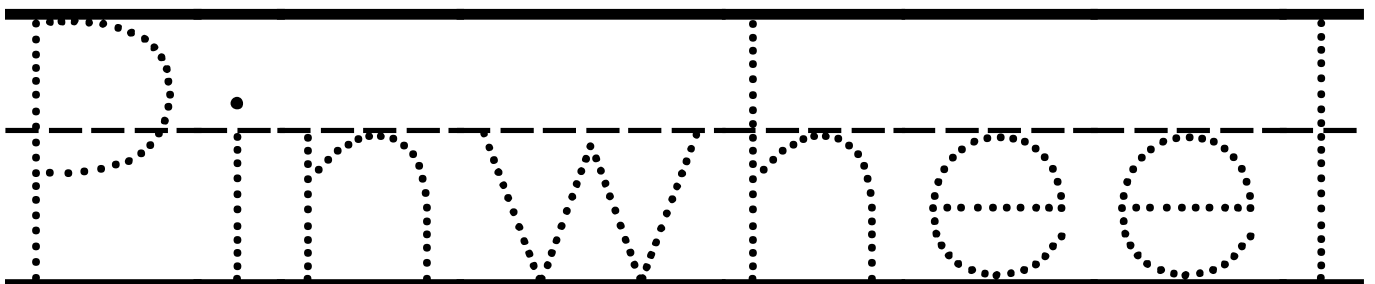
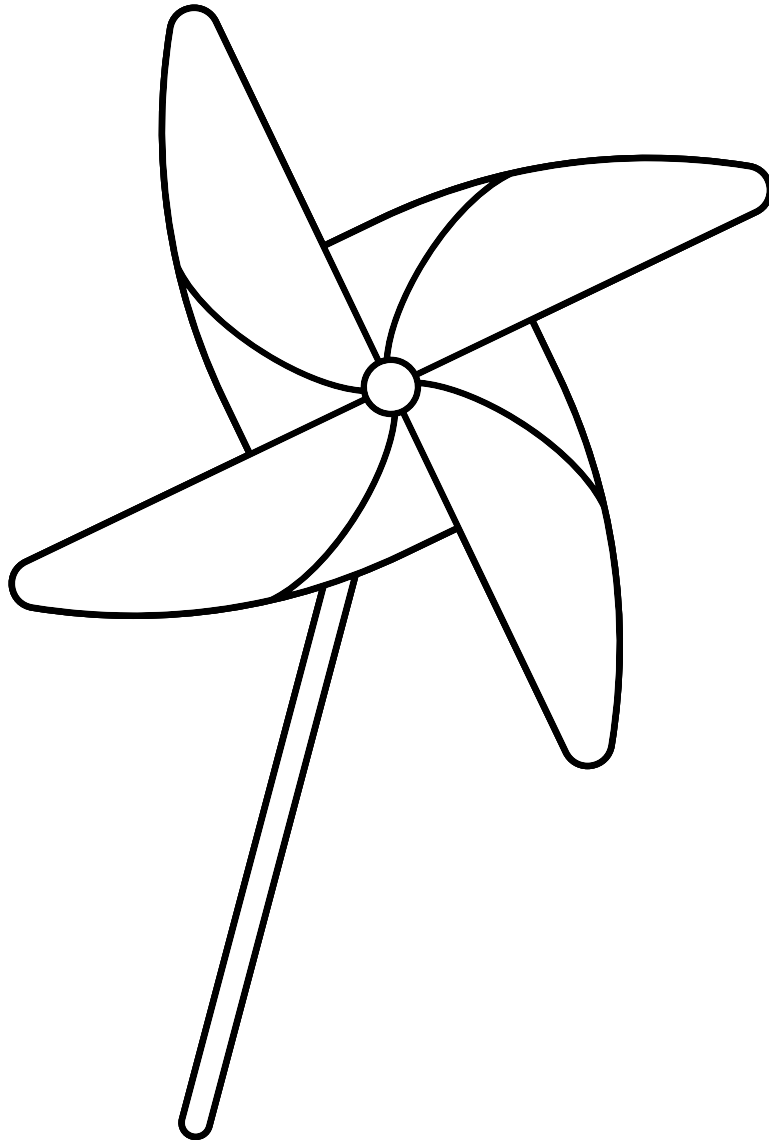



Name: _____

Date: _____

Directions: Color the drawing and trace the word.

Alphabet Q

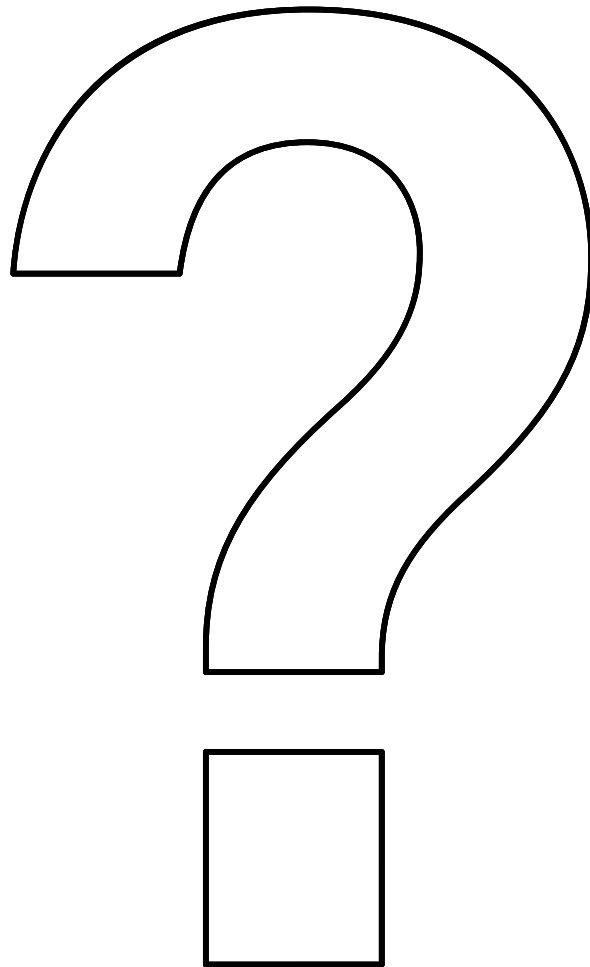

Question

Mark

Name: _____

Date: _____

Directions: Color the drawing and trace the word.

Alphabet A to Z

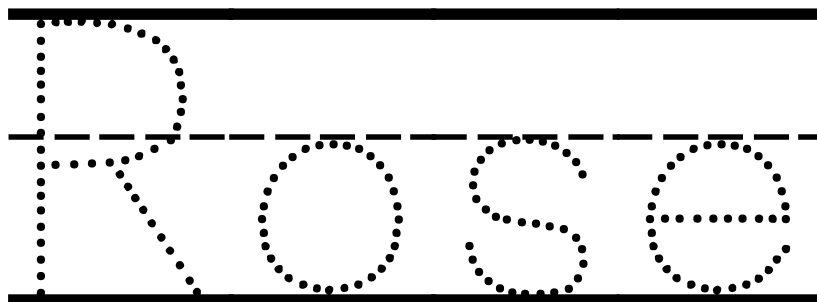
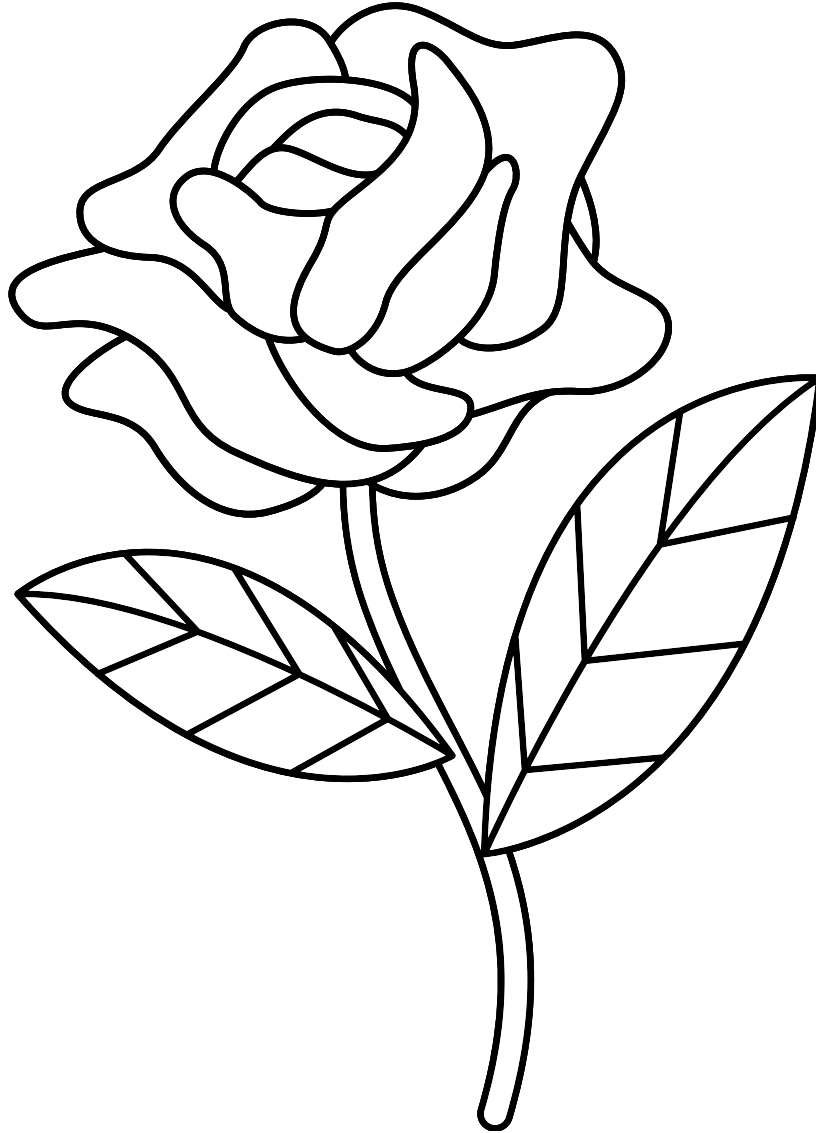

Name: _____

Date: _____

Directions: Color the drawing and trace the word.

Alphabet S

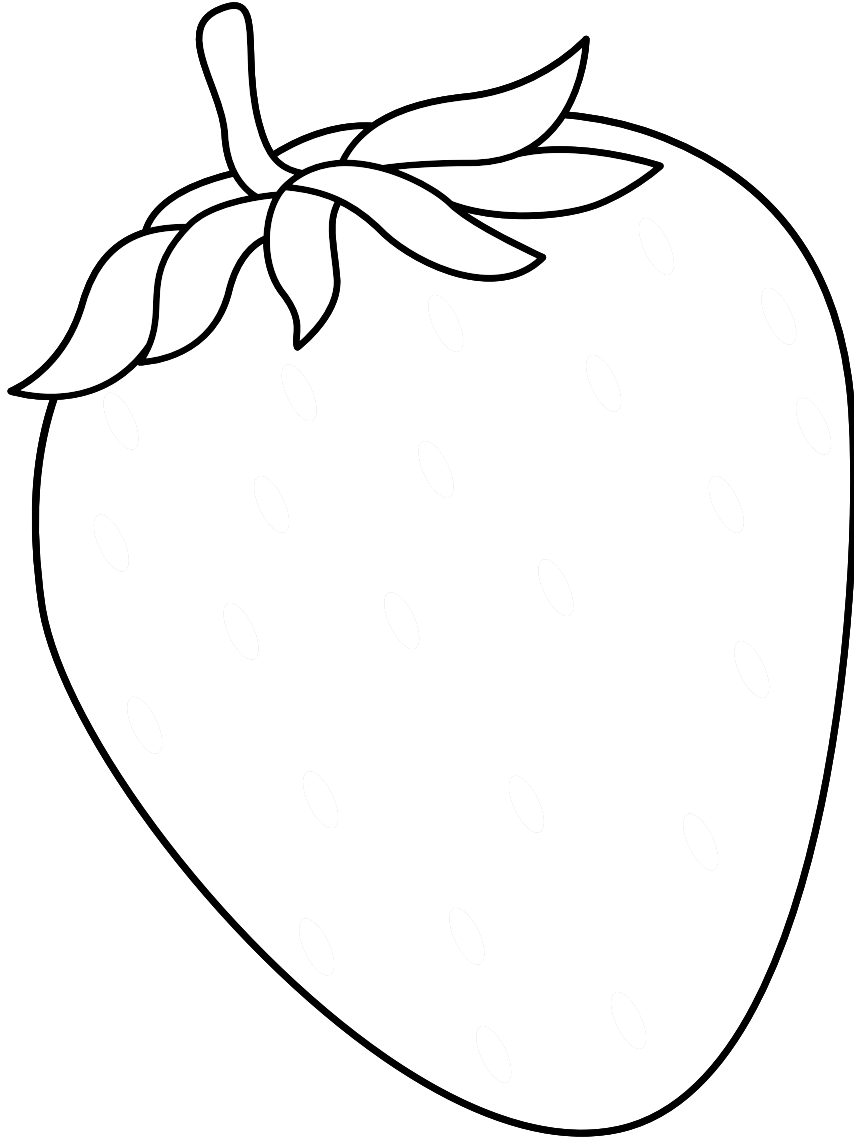

Strawberry

Name: _____

Date: _____

Directions: Color the drawing and trace the word.

Alphabet T

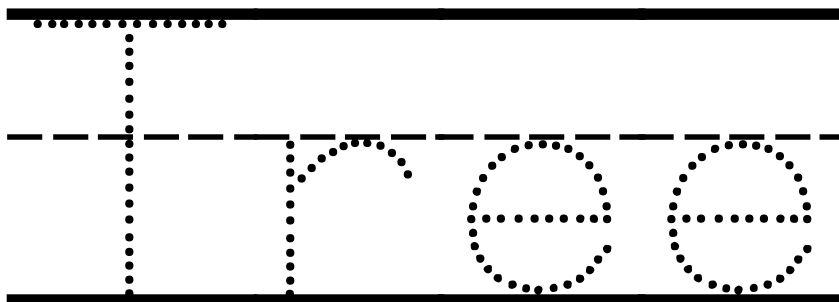
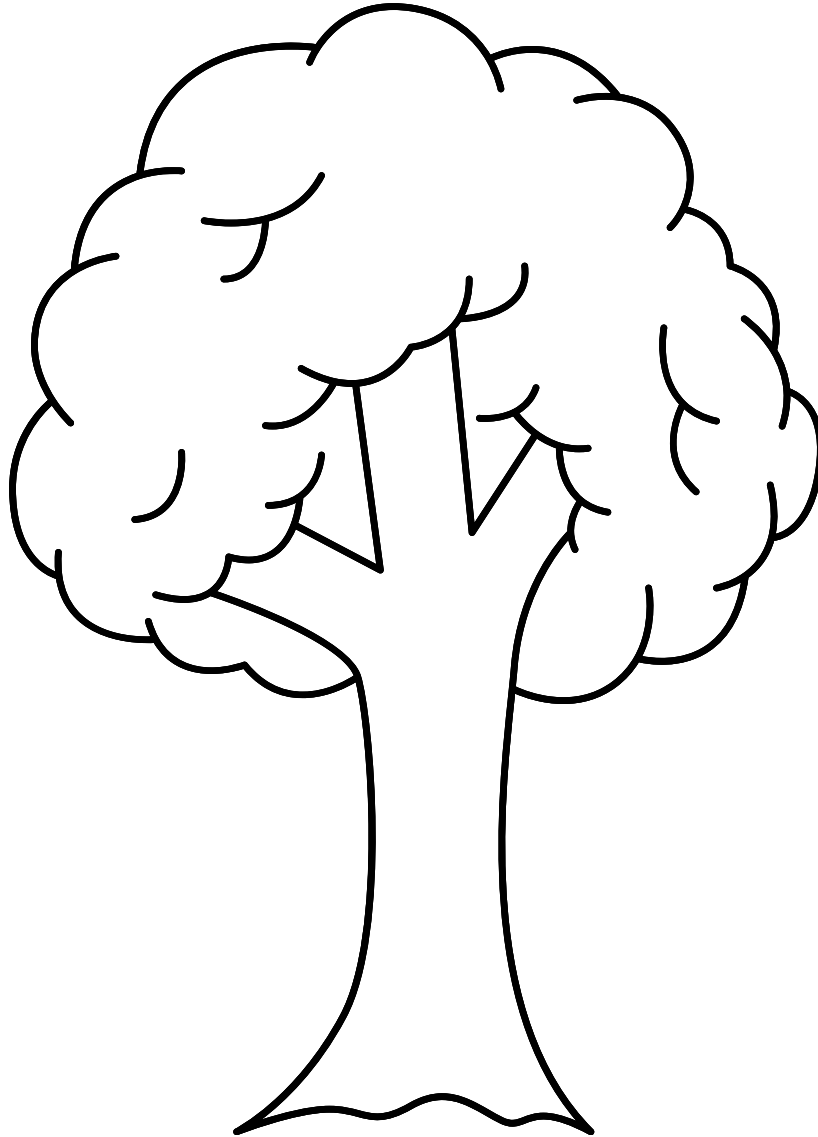

Name: _____

Date: _____

Directions: Color the drawing and trace the word.

Alphabet U

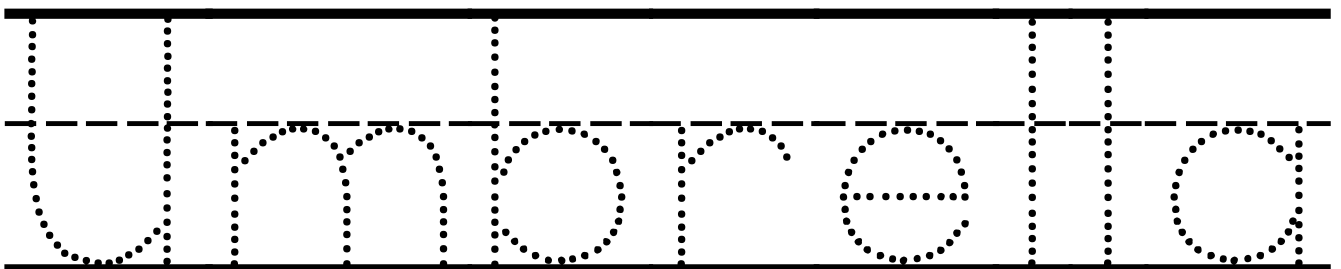

Name: _____

Date: _____

Directions: Color the drawing and trace the word.

Alphabet V

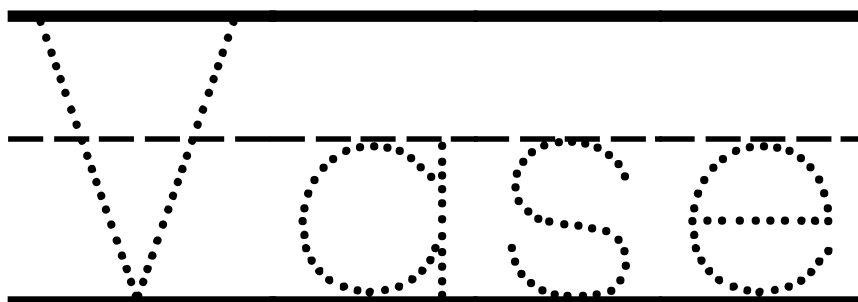
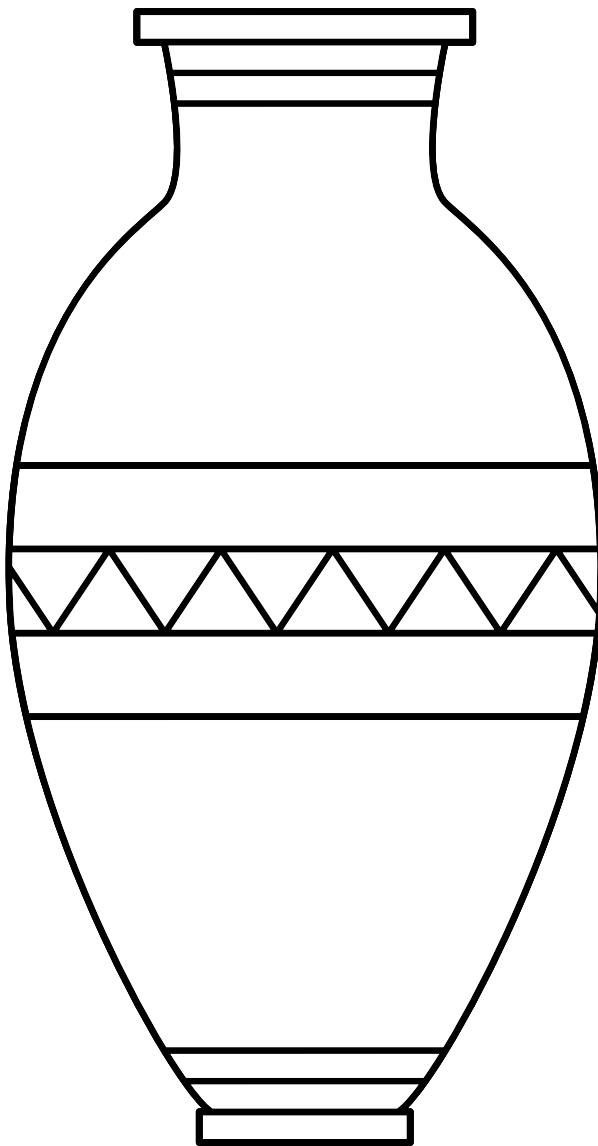

Name: _____

Date: _____

Directions: Color the drawing and trace the word.

Alphabet W

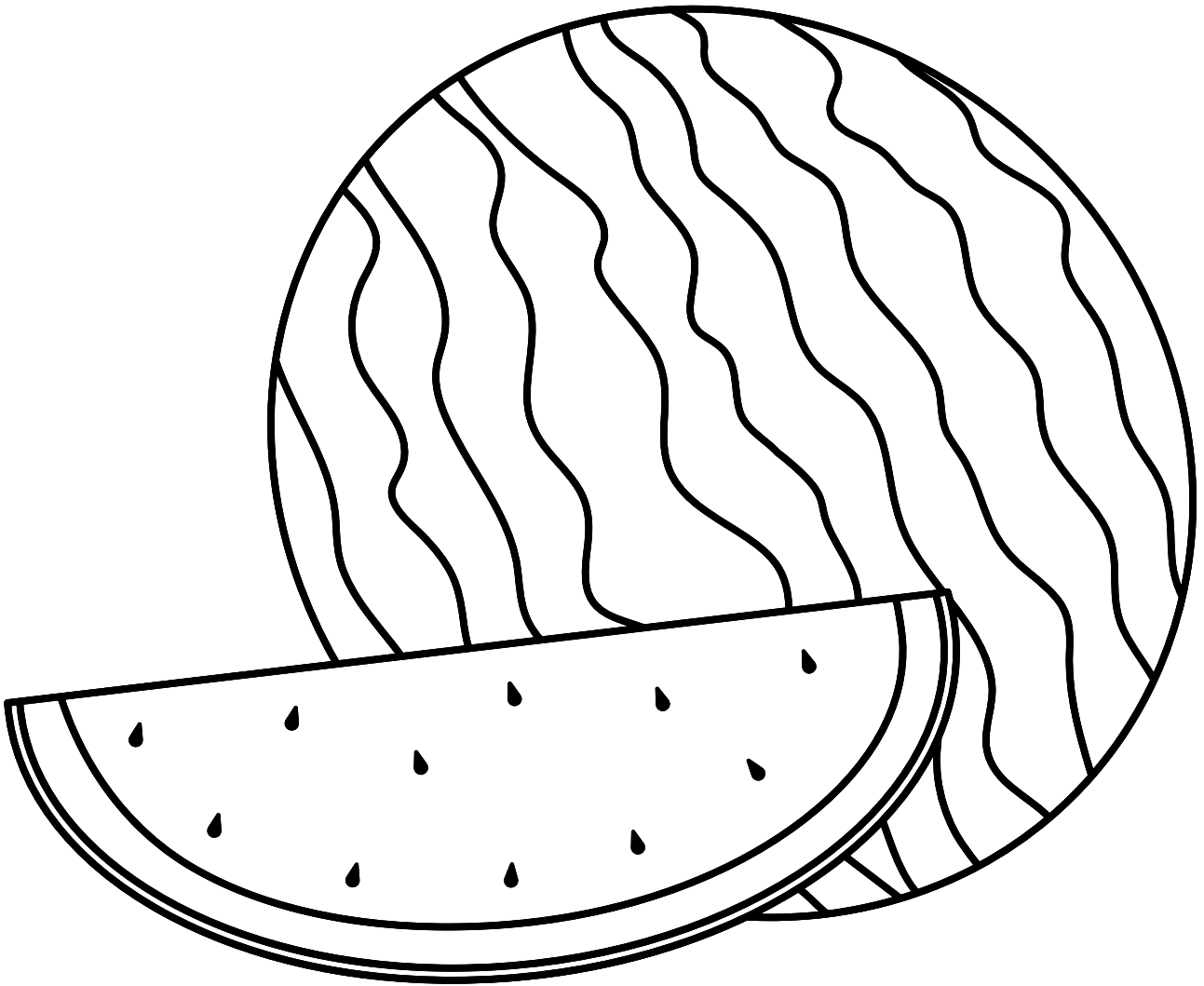

Watermelon

Name: _____

Date: _____

Directions: Color the drawing and trace the word.

Alphabet X

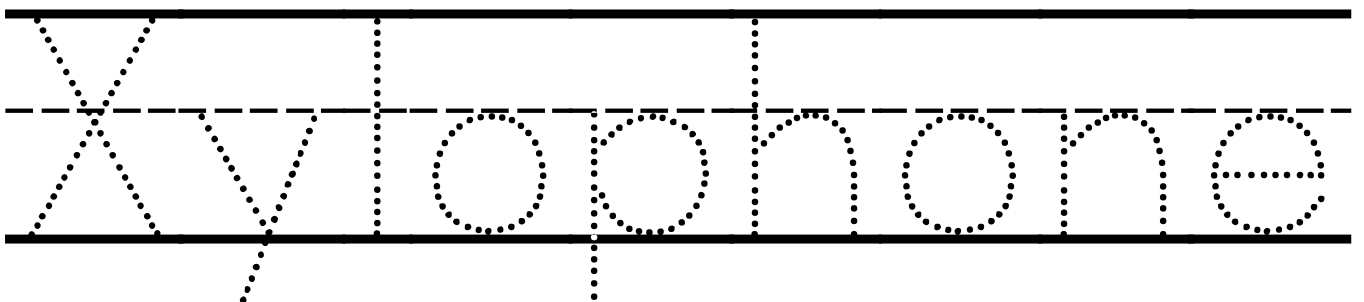
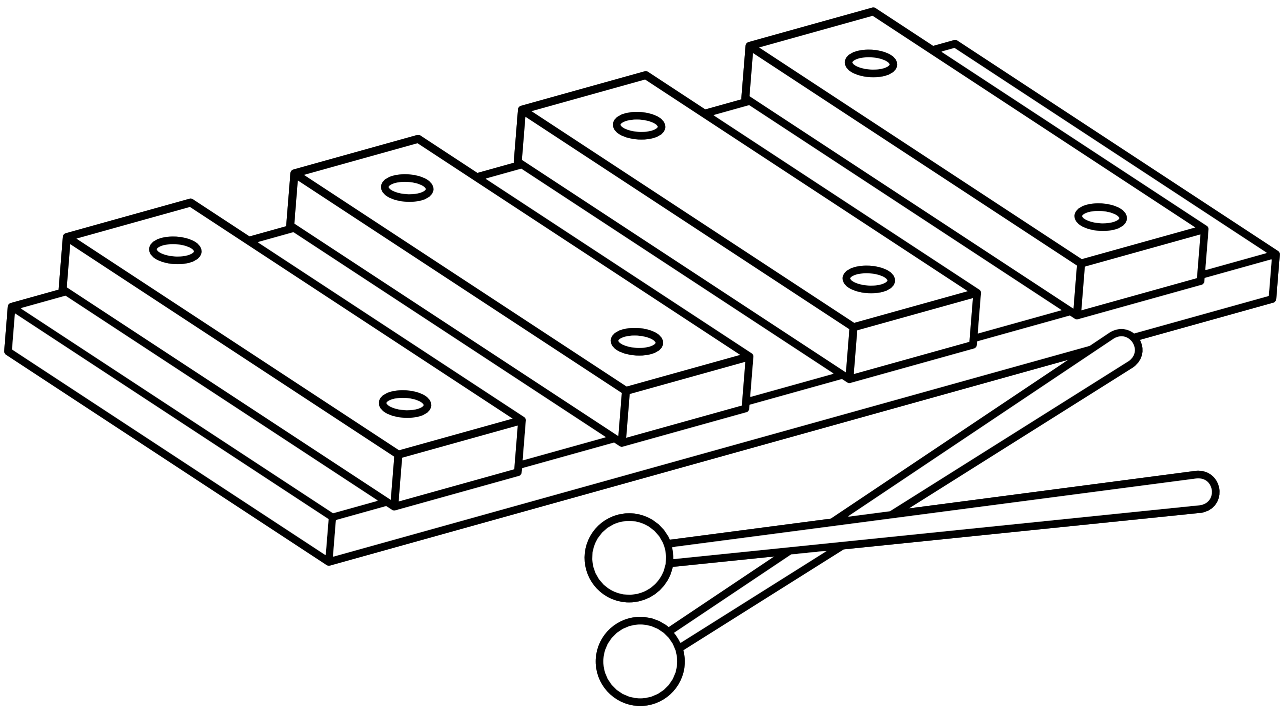

Name: _____

Date: _____

Directions: Color the drawing and trace the word.

Alphabet Y

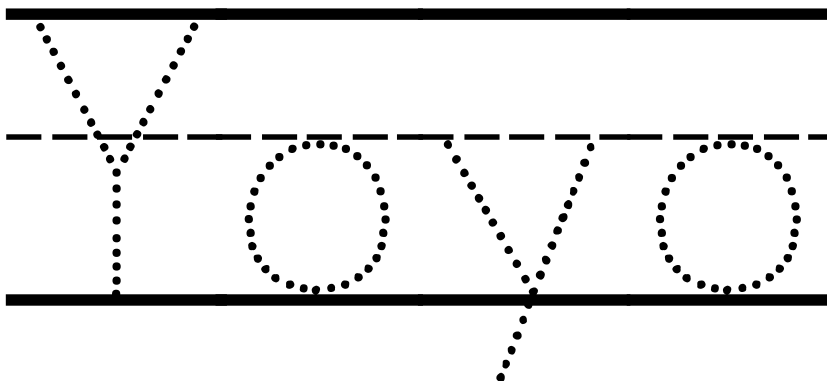
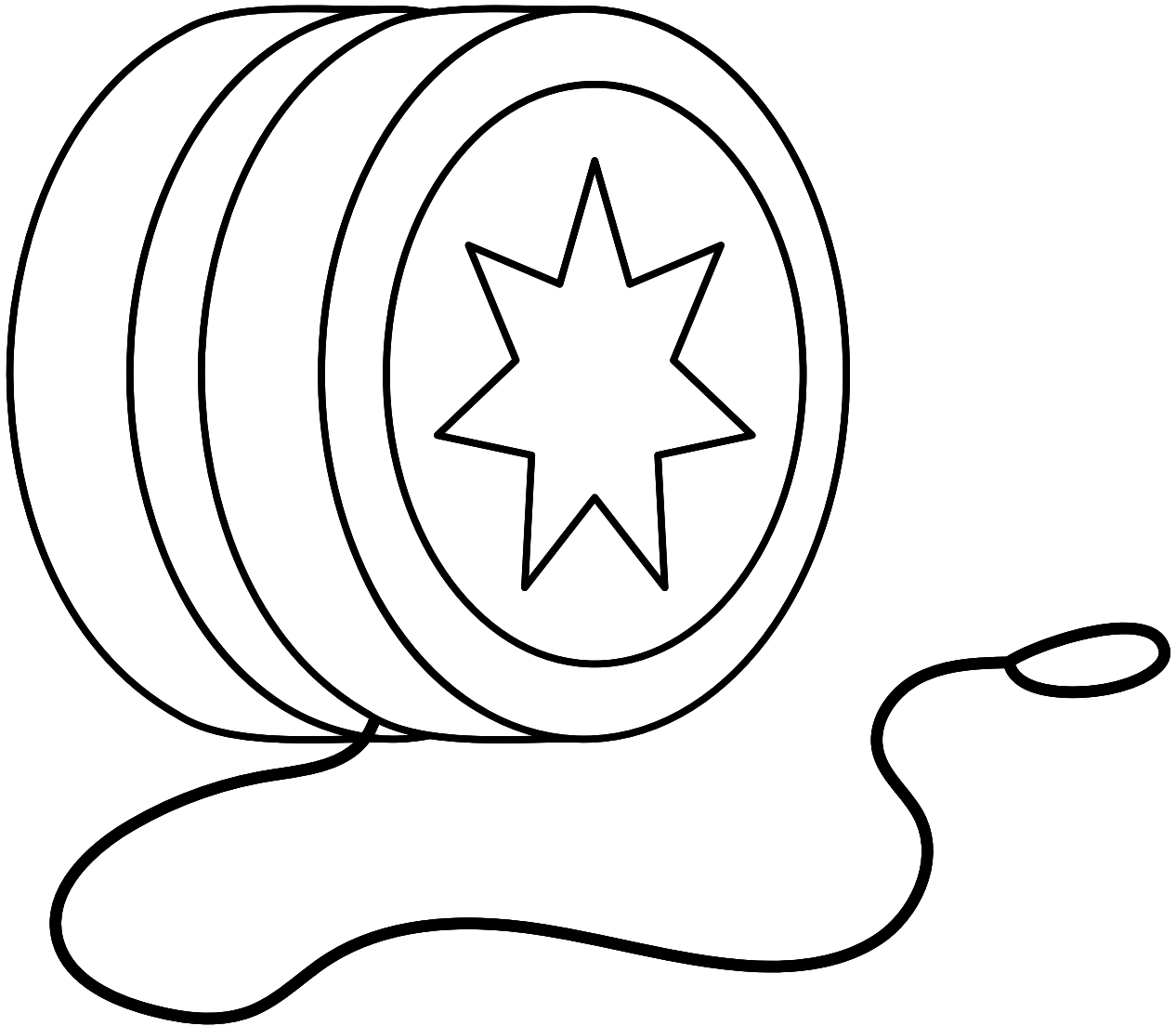

Name: _____

Date: _____

Directions: Color the drawing and trace the word.

Alphabet Z

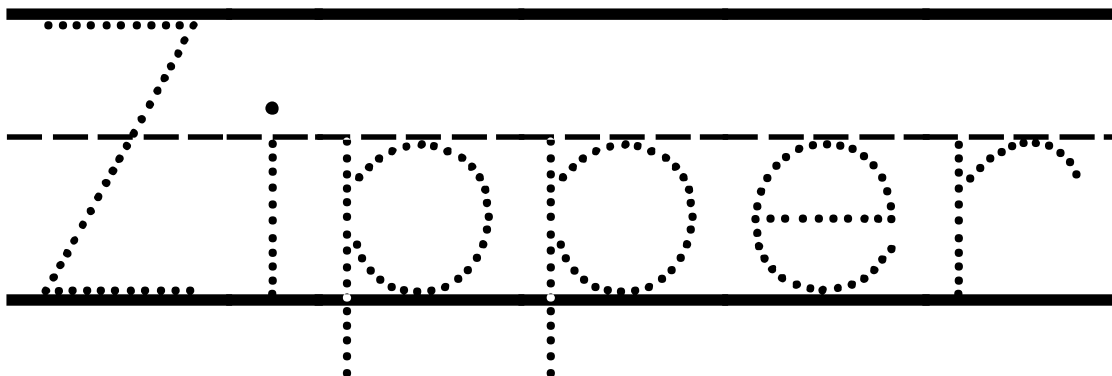
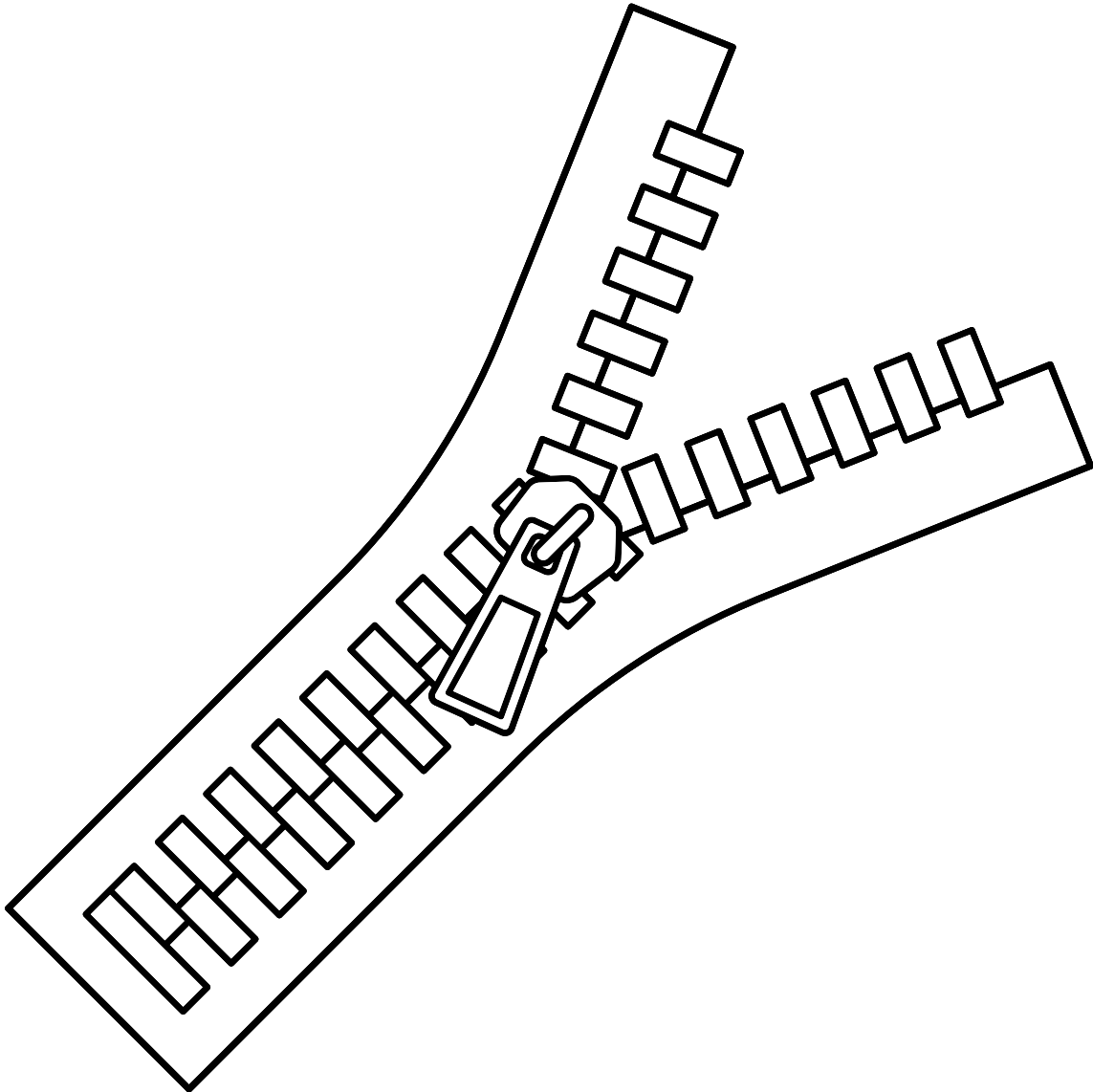



Alphabet A to Z Coloring and Tracing Worksheet Set