

Preschool Worksheets



Ages 3-5



© 2025 Smiles Preschool. All Rights Reserved.



NUMBER TRACING WORKSHEET

1

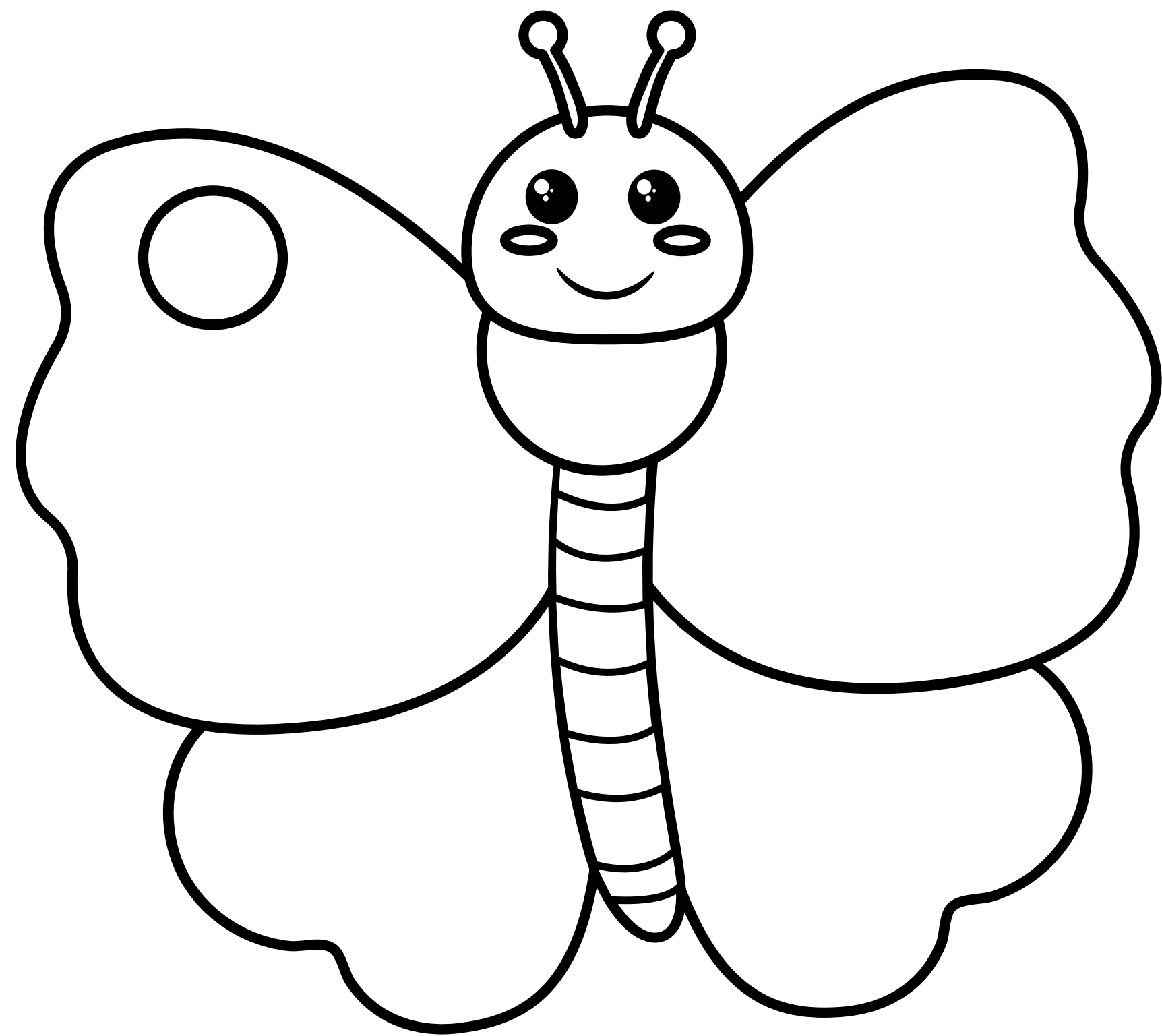

one

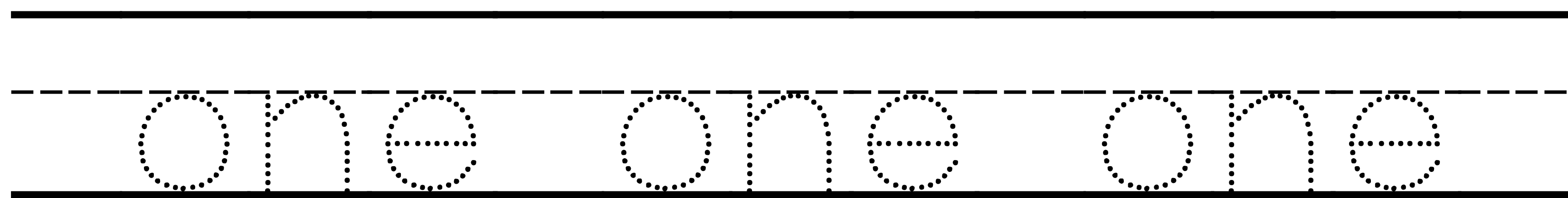
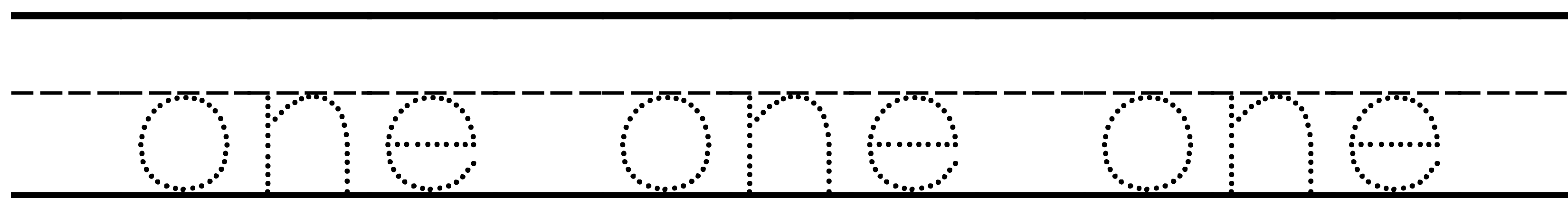
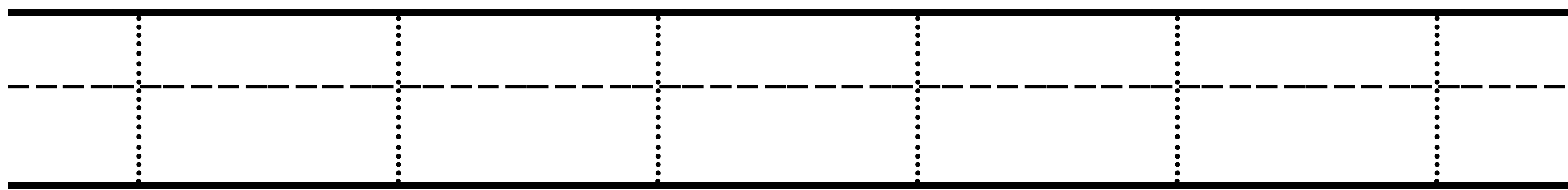
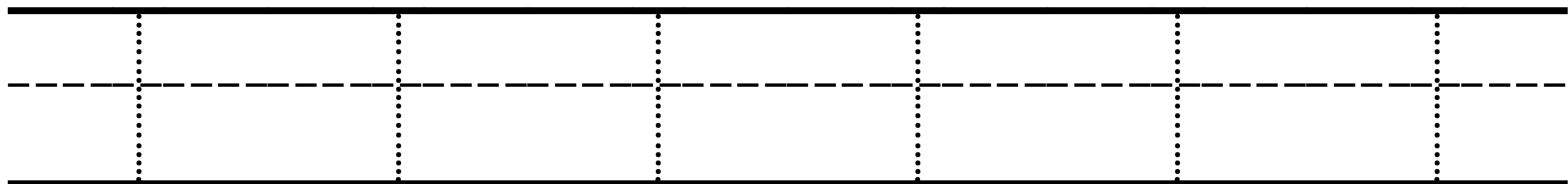



NUMBER TRACING WORKSHEET

2

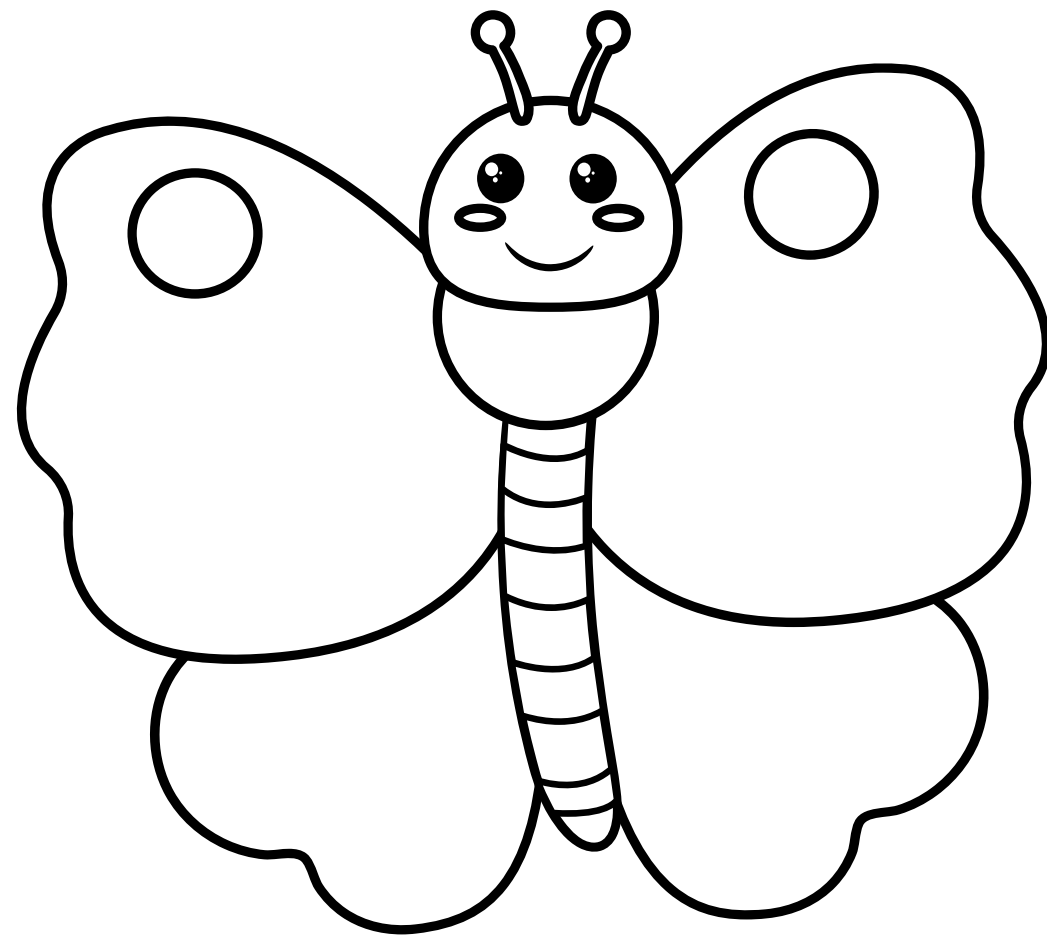

two

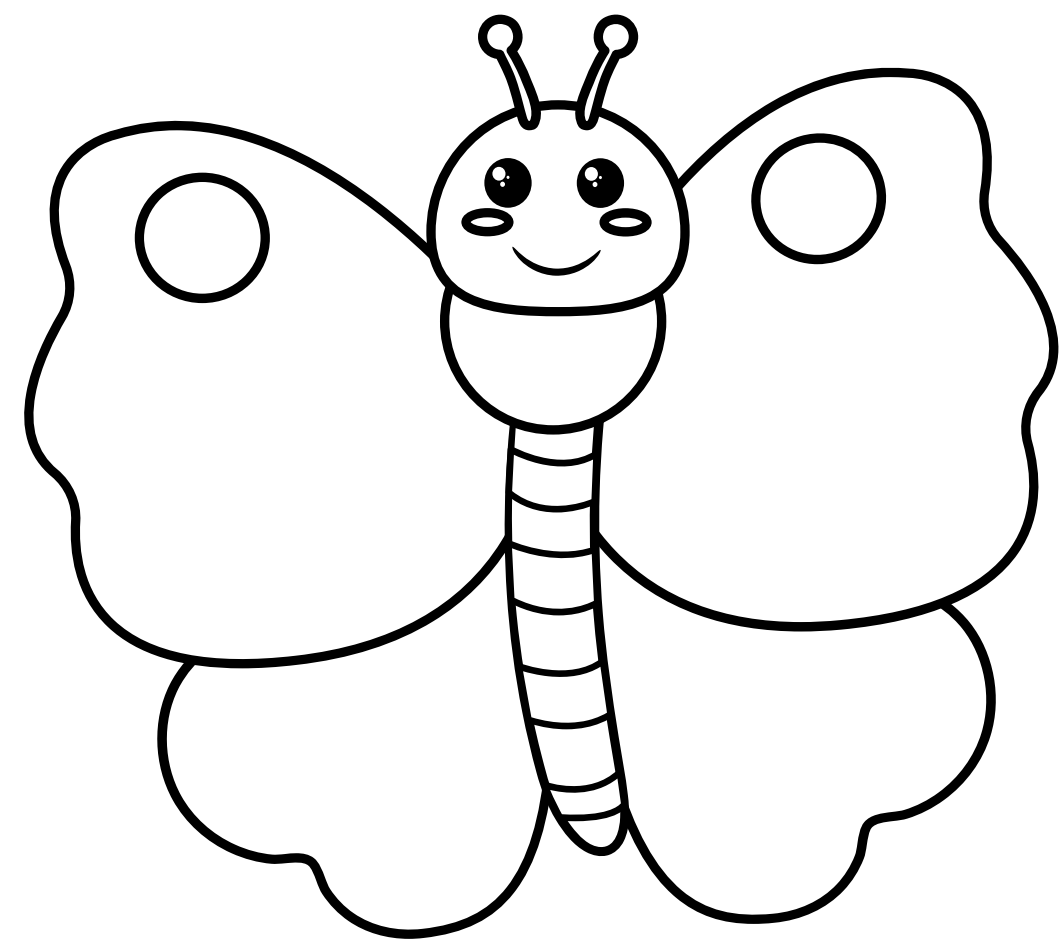

2 2 2 2 2

2 2 2 2 2

two two two

two two two



NUMBER TRACING WORKSHEET

3

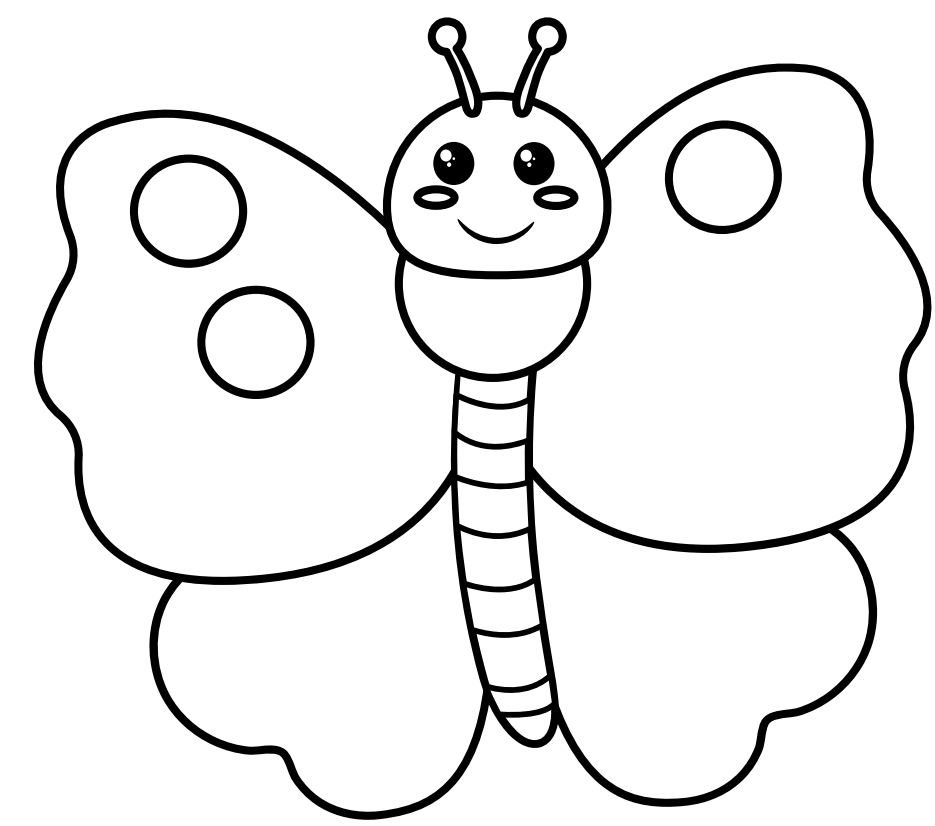
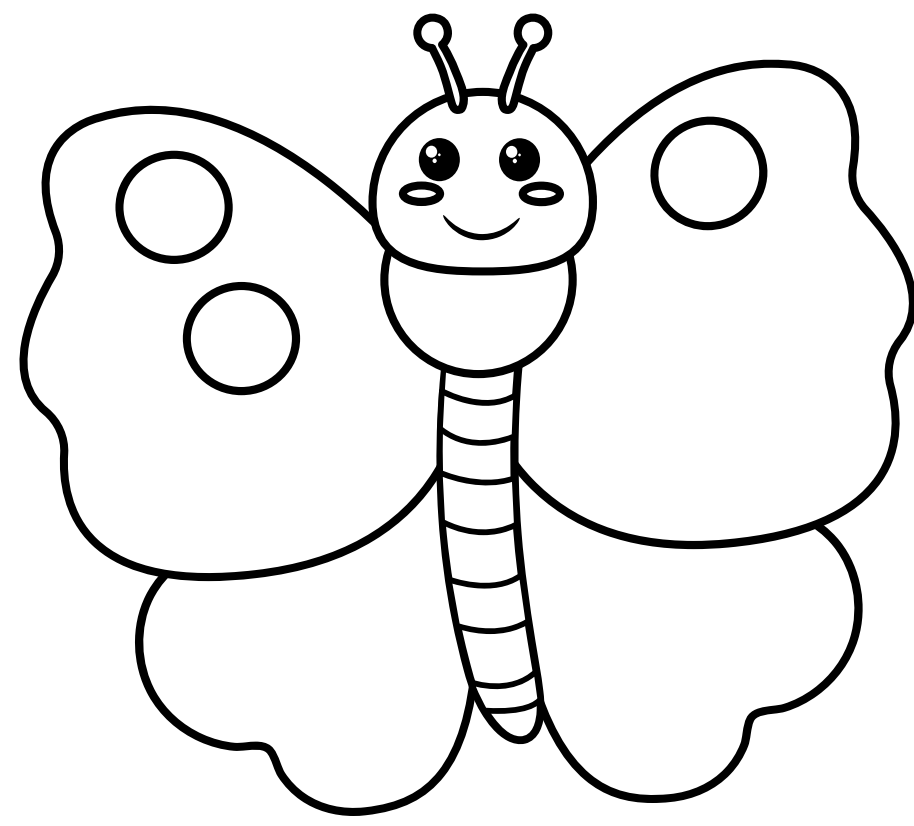

three

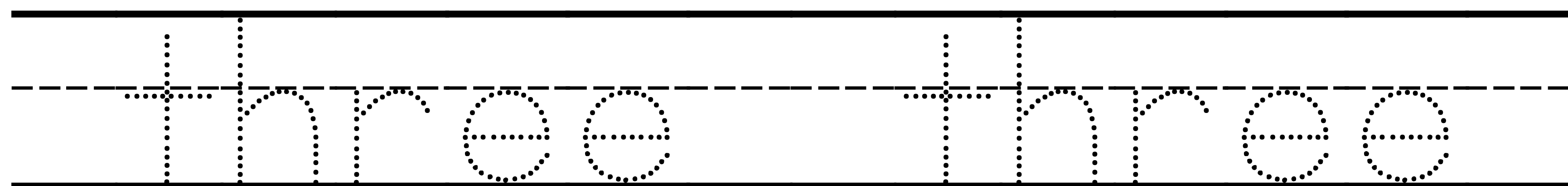
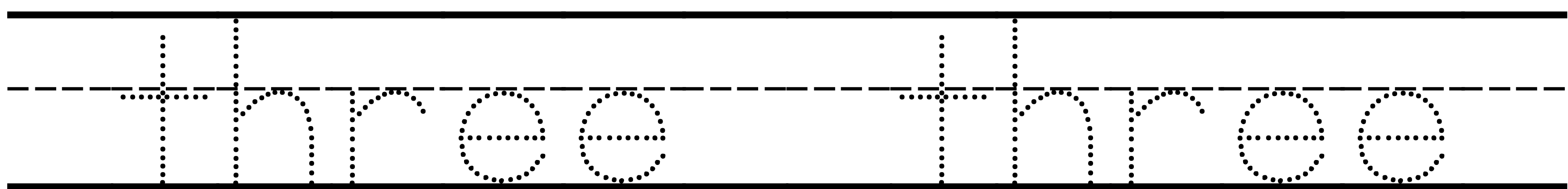
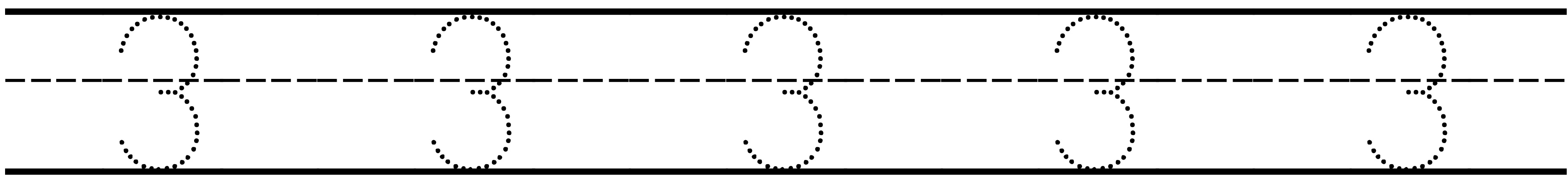
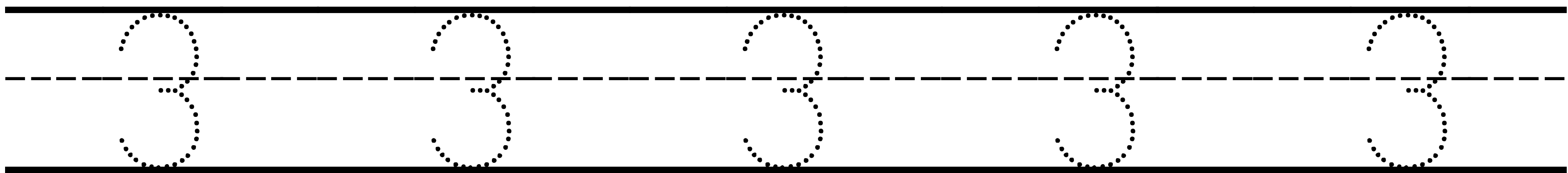
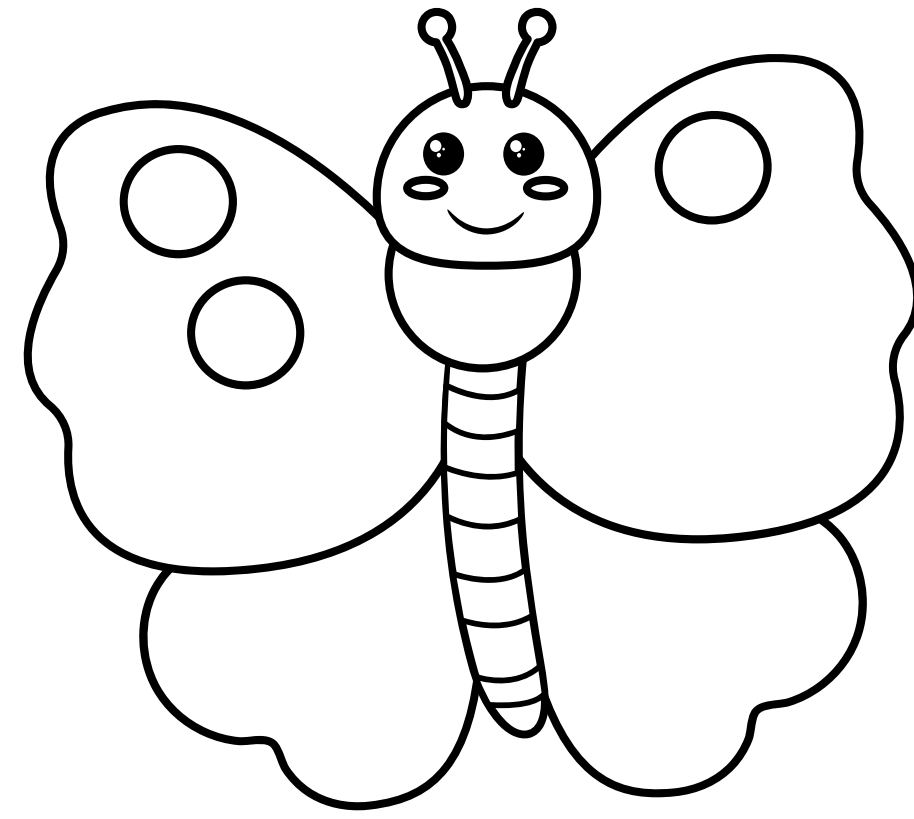



NUMBER TRACING WORKSHEET

4

four

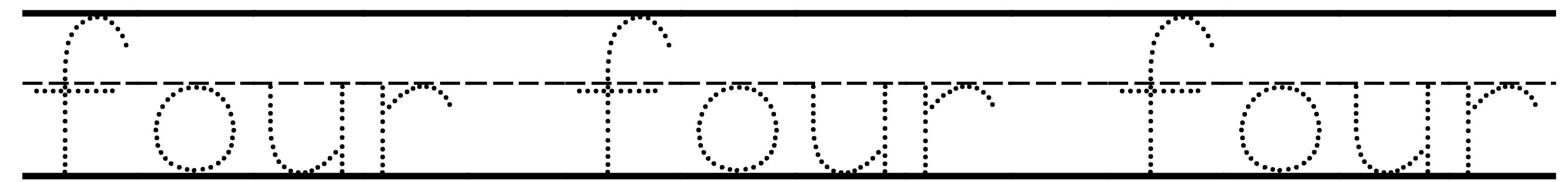
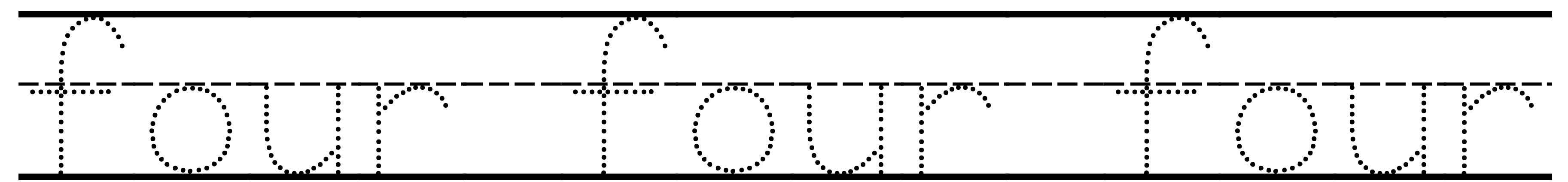
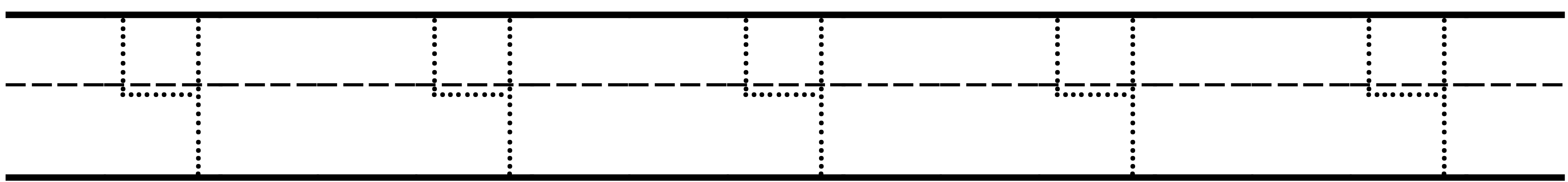
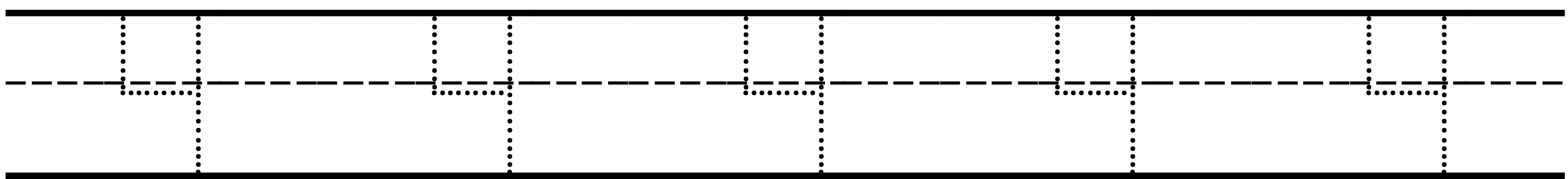
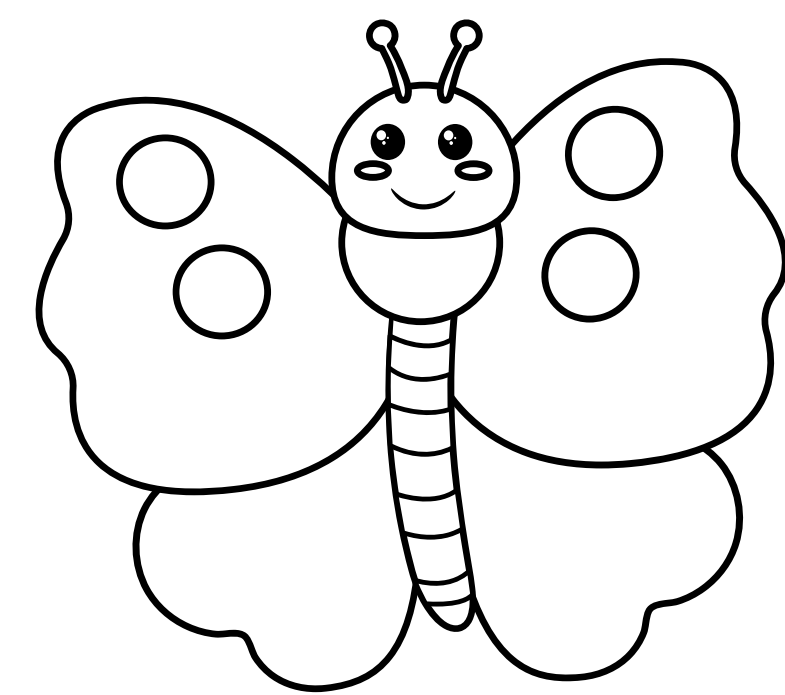
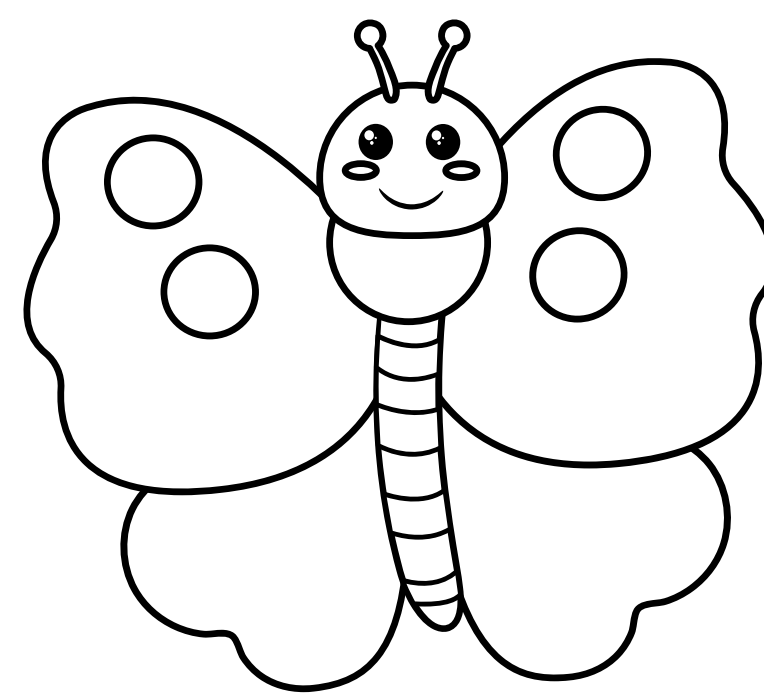
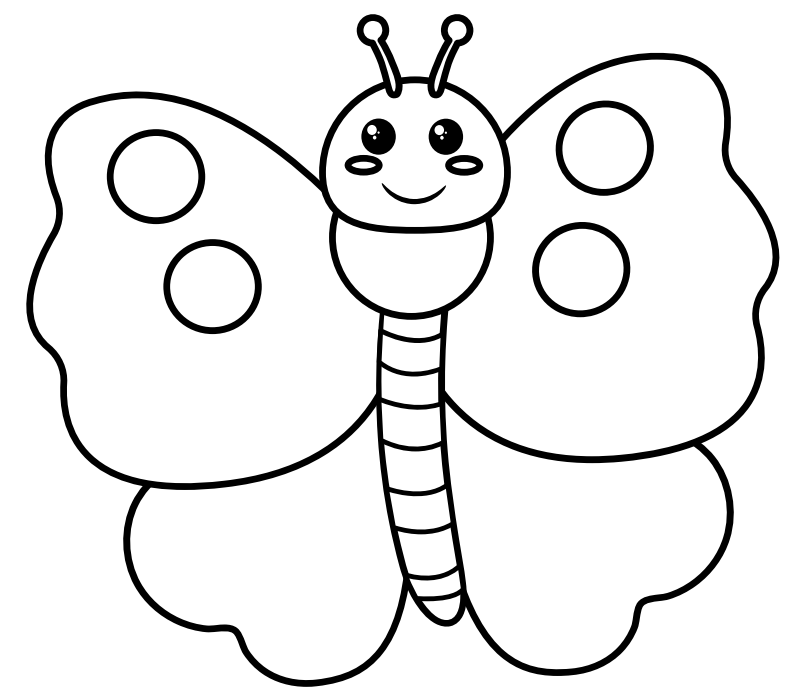
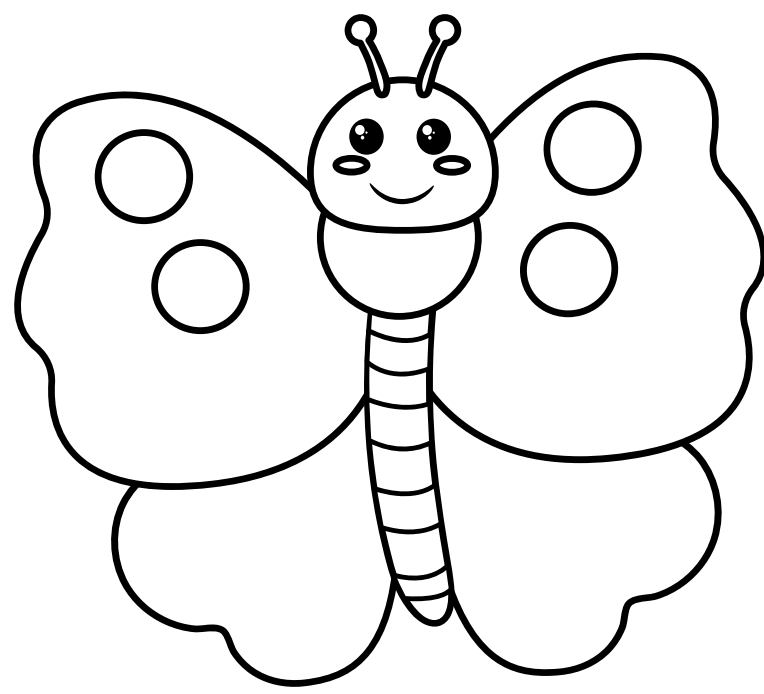



NUMBER TRACING WORKSHEET

5

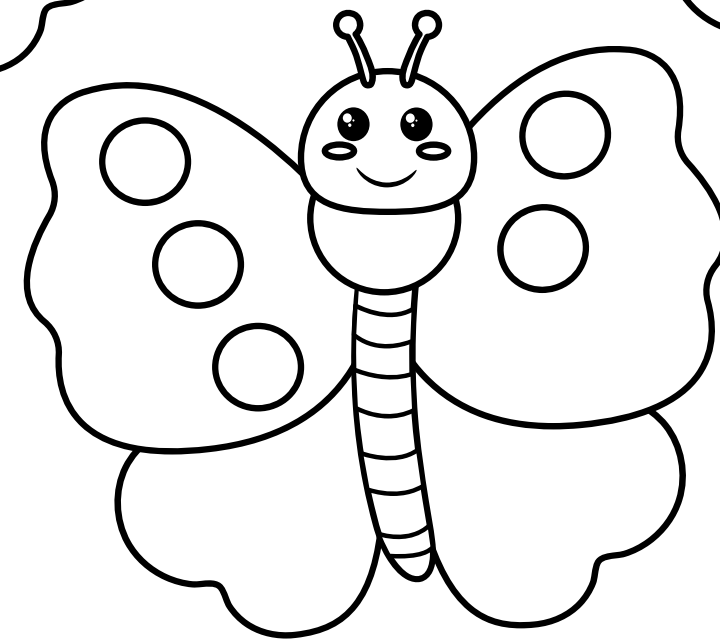
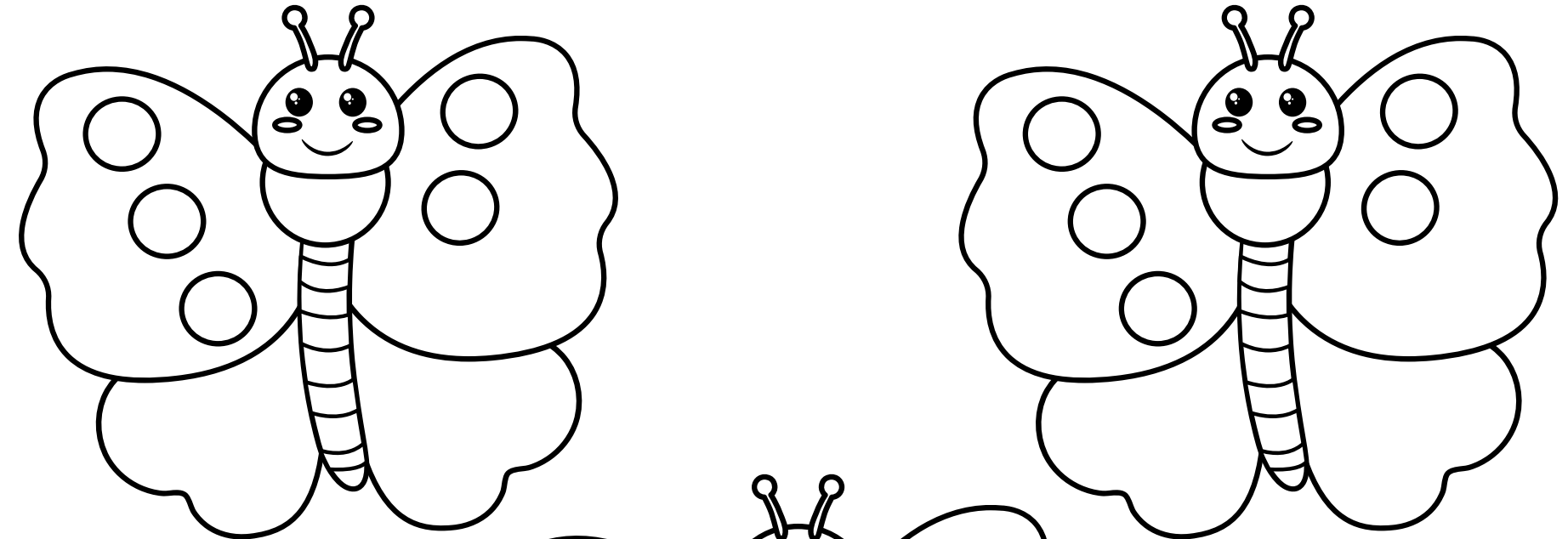

five

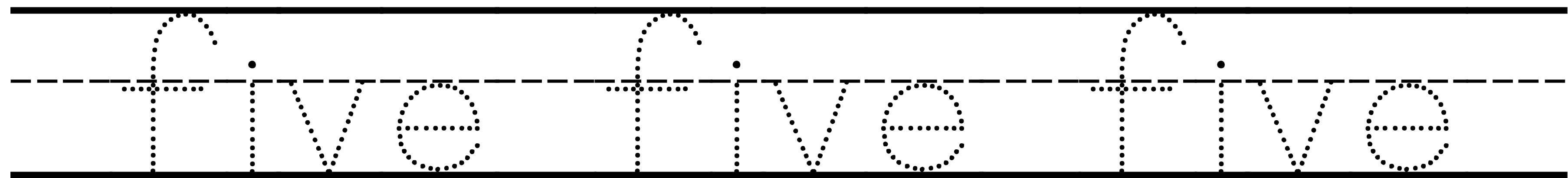
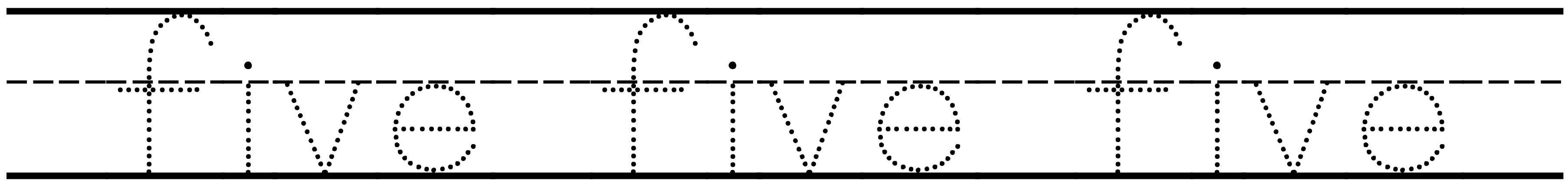
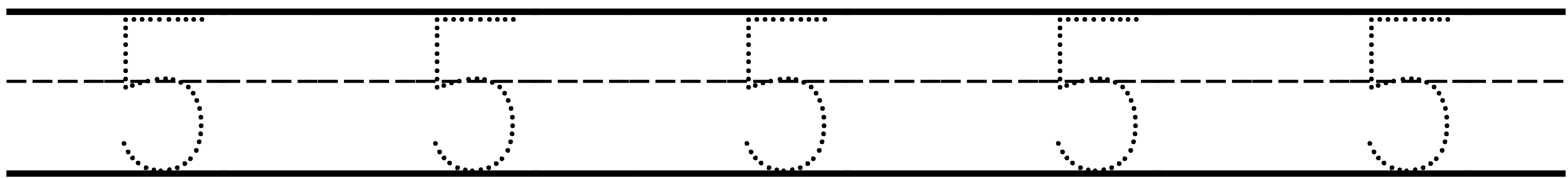
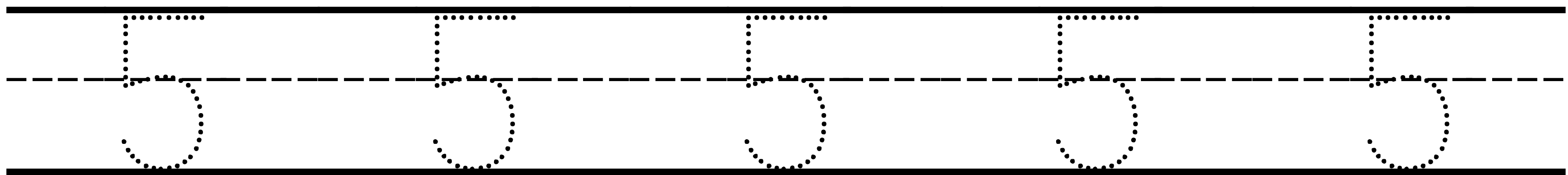
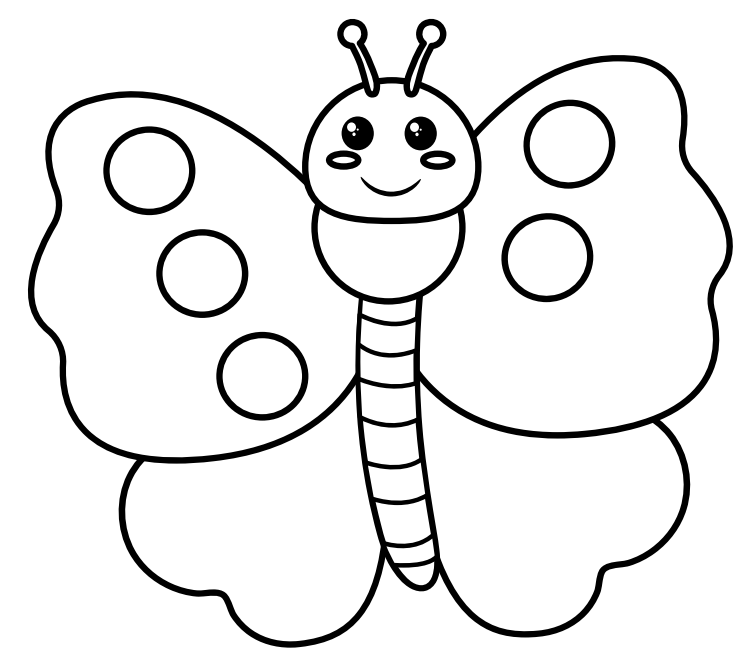
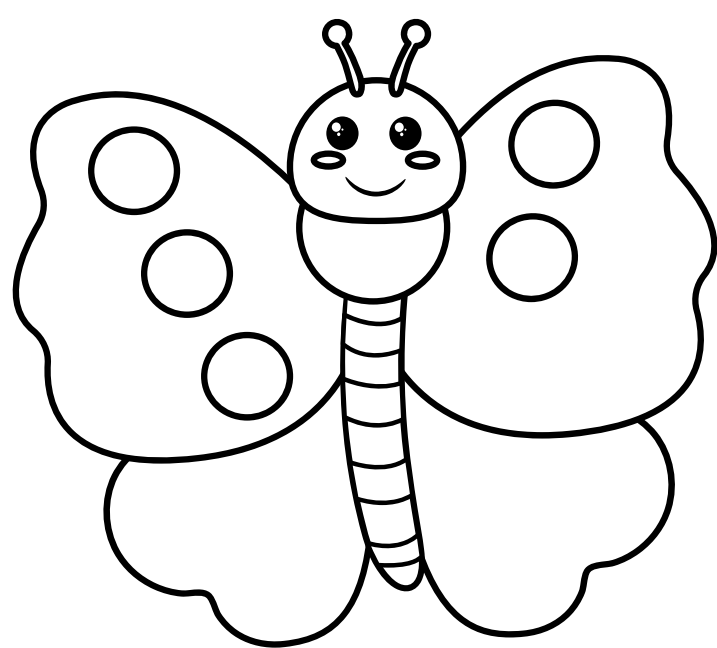



NUMBER TRACING WORKSHEET

6

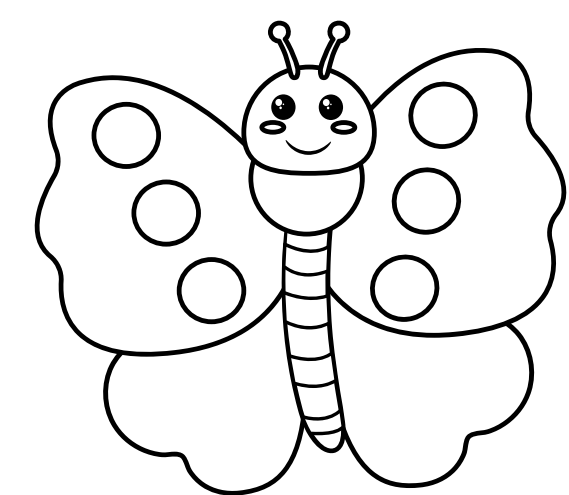
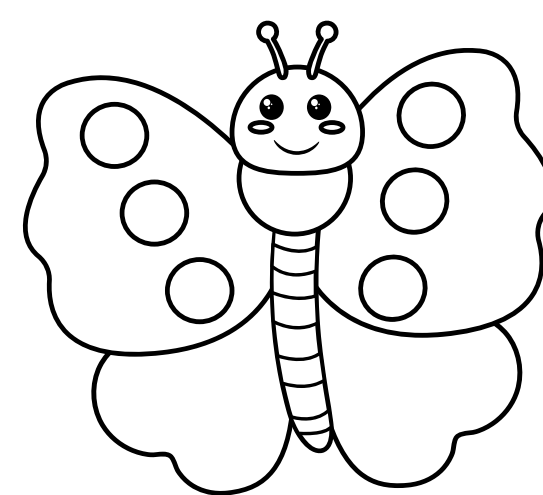
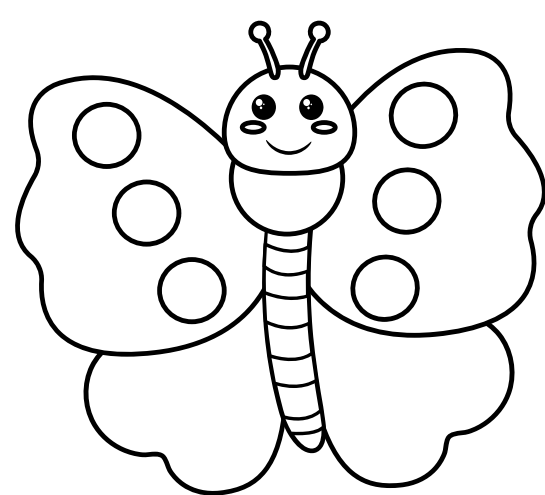
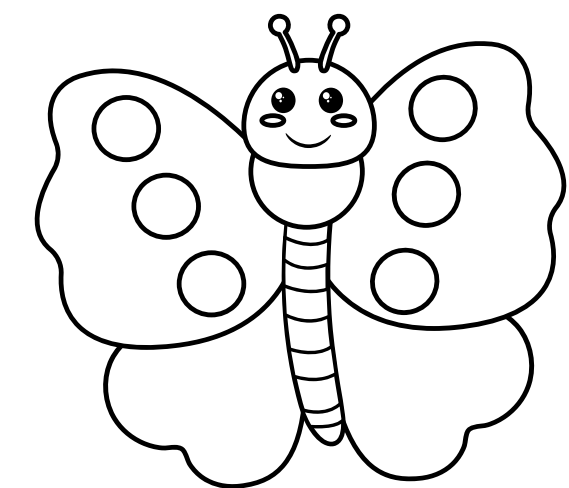
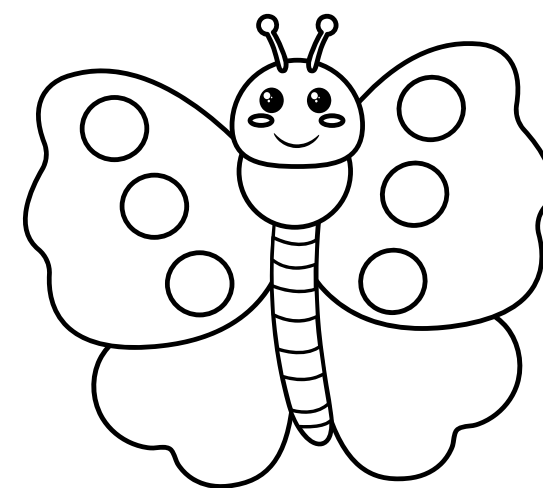
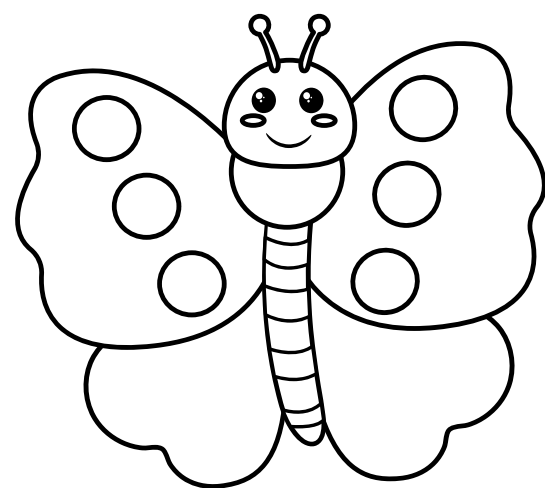

six

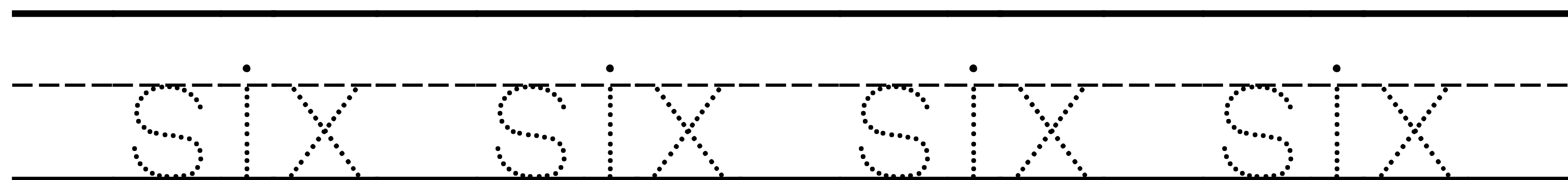
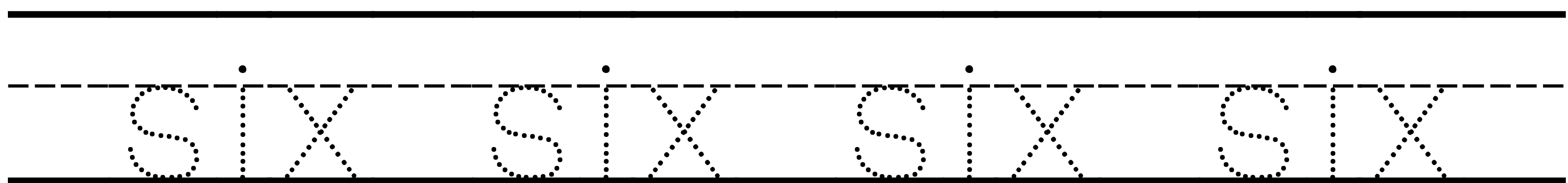
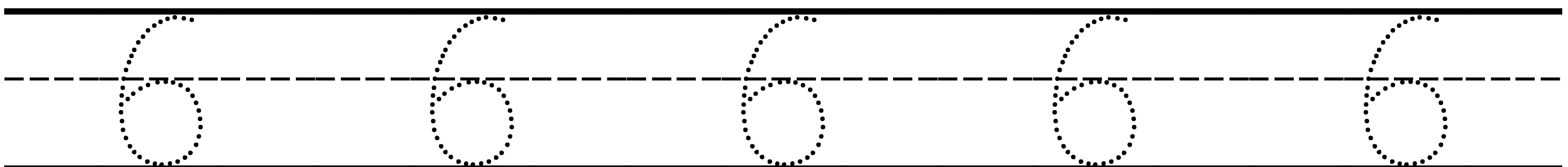
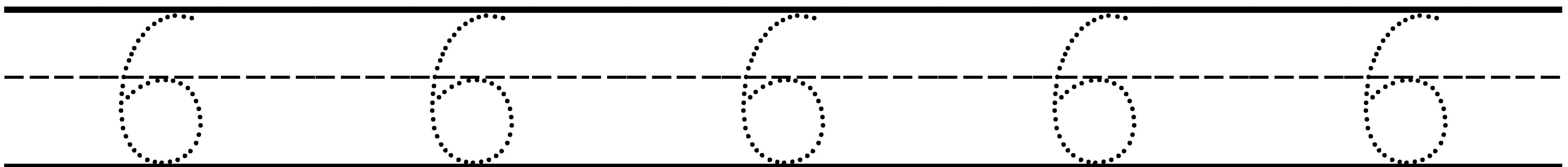



NUMBER TRACING WORKSHEET

7

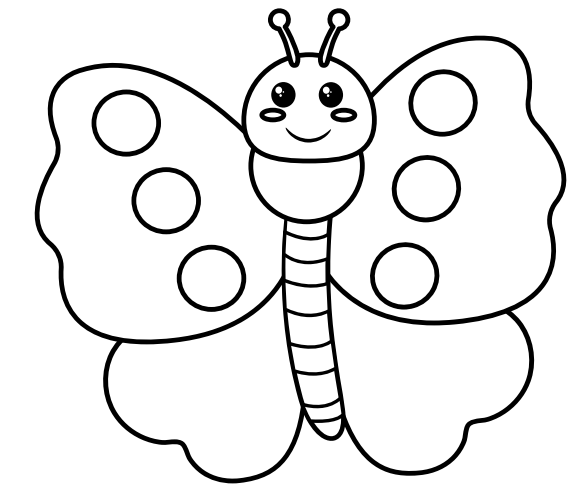
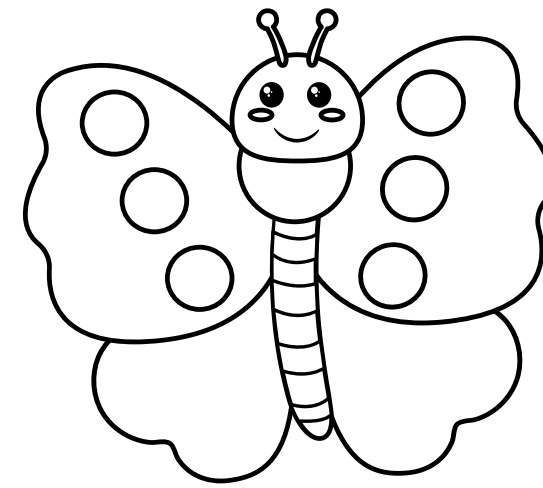
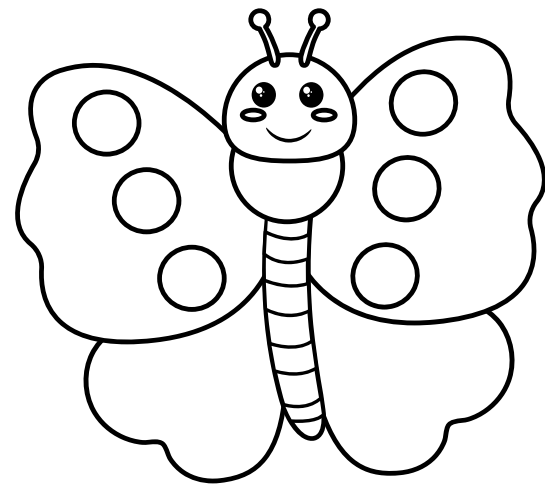
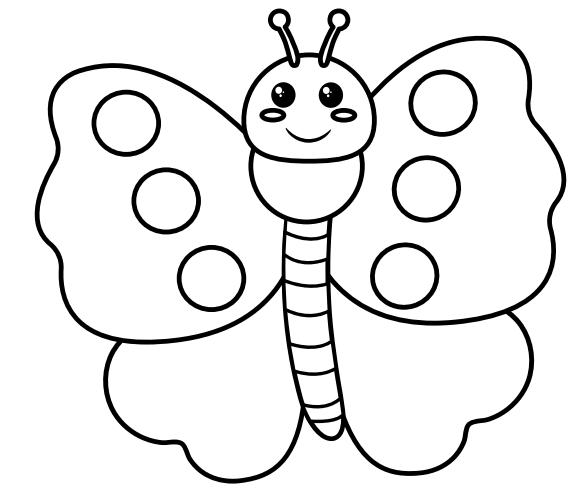
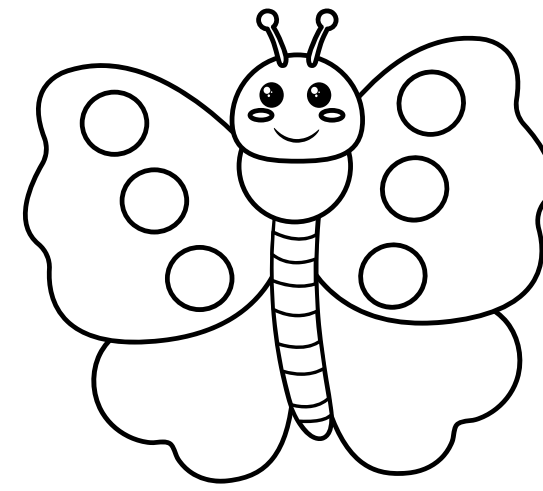
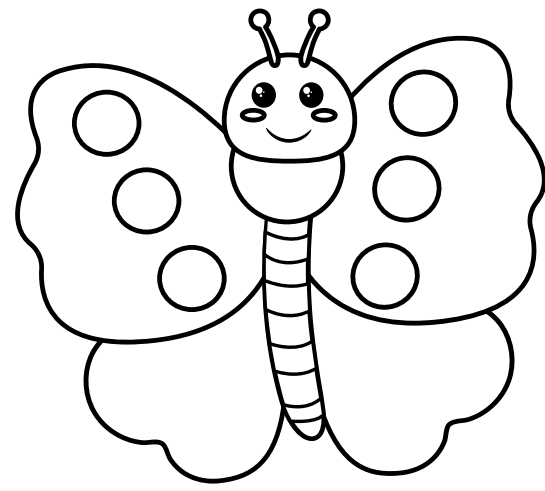

seven

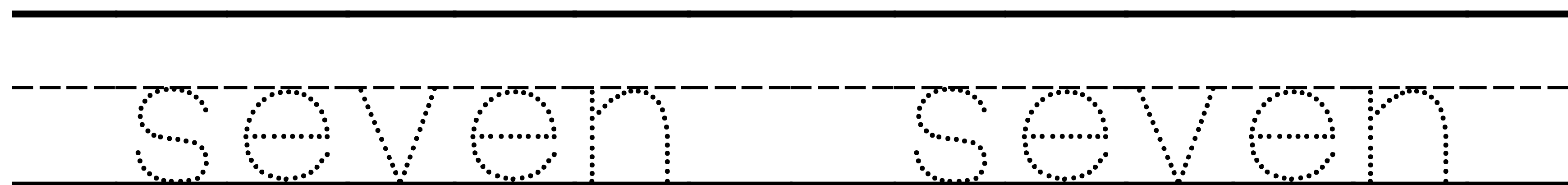
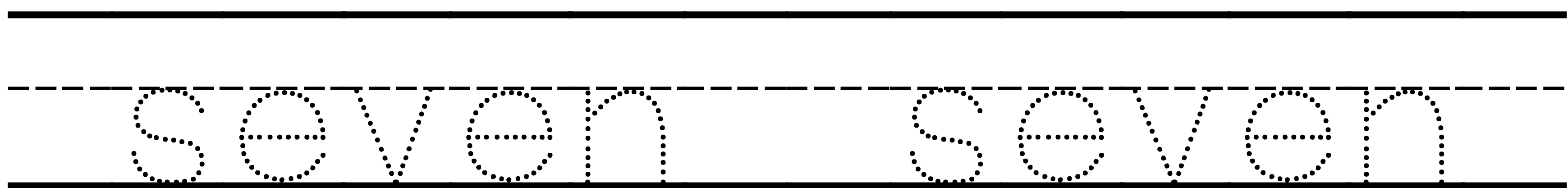
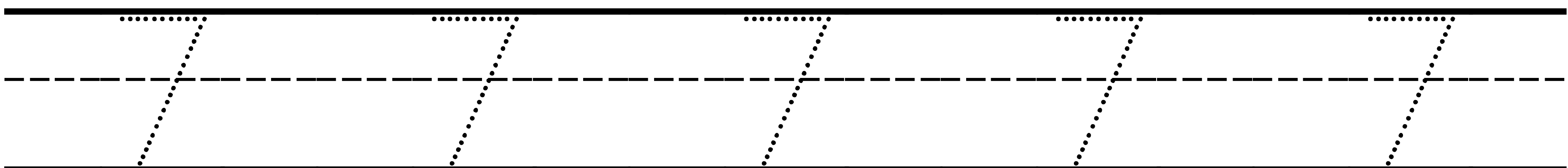
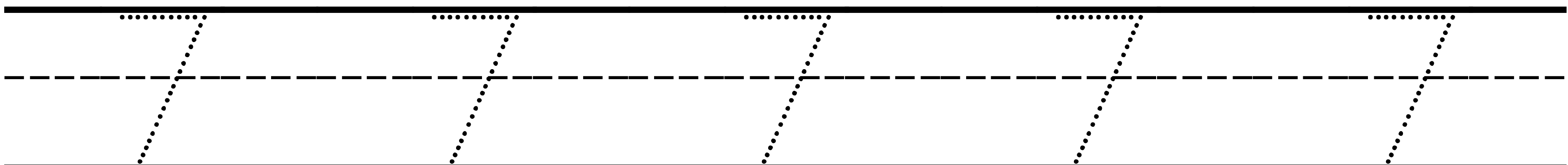
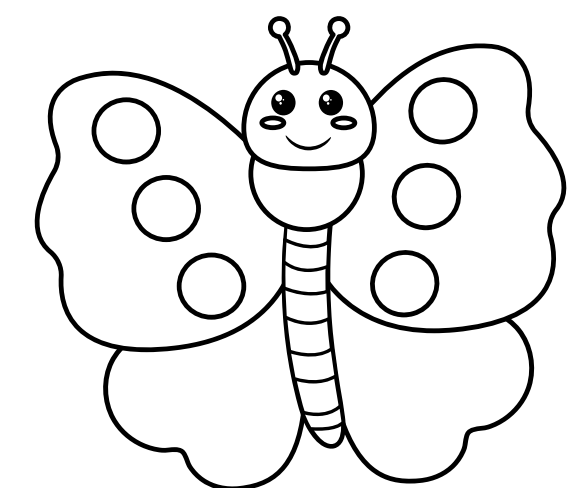



NUMBER TRACING WORKSHEET

8

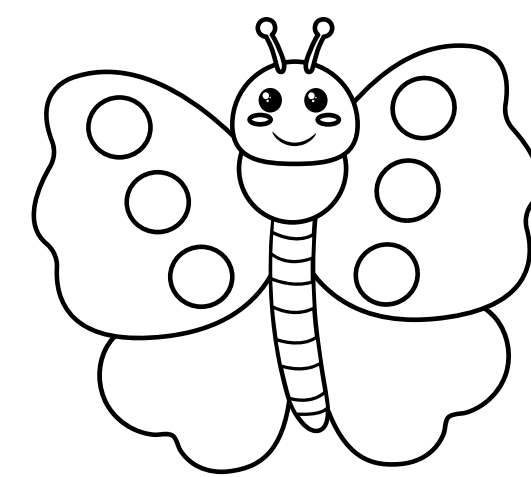
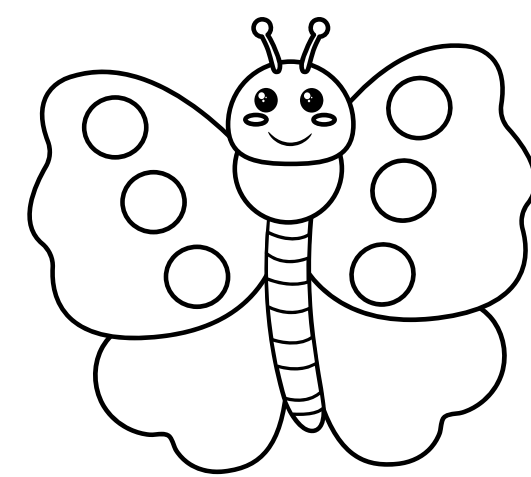
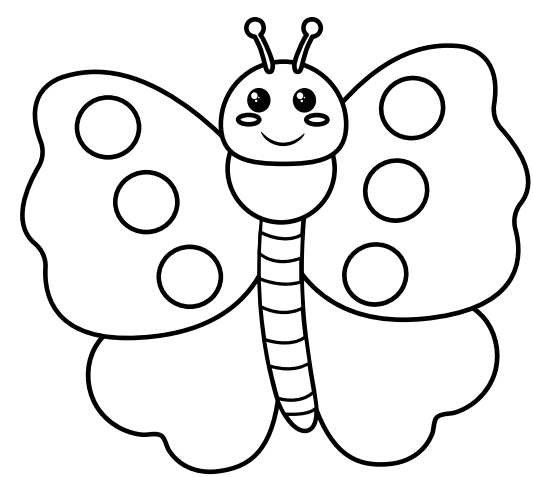
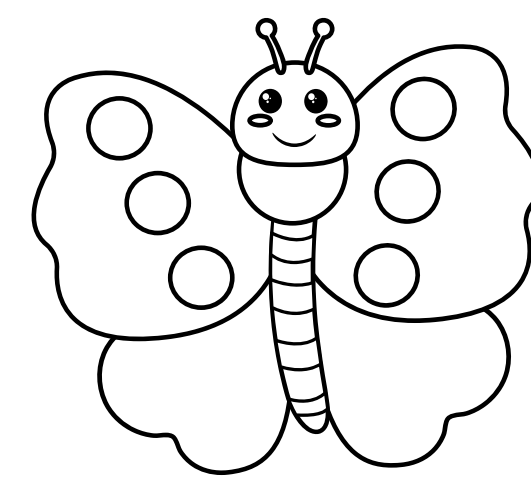
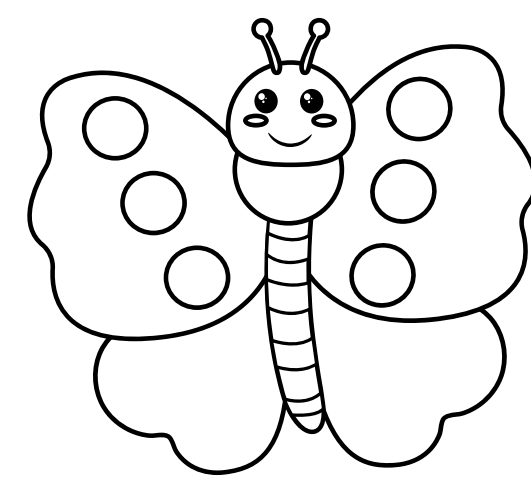
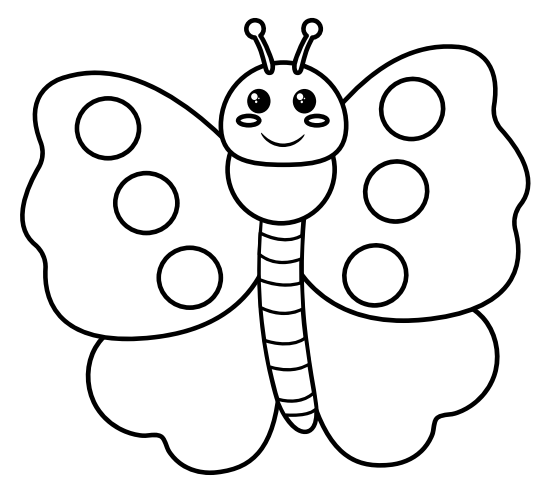

eight

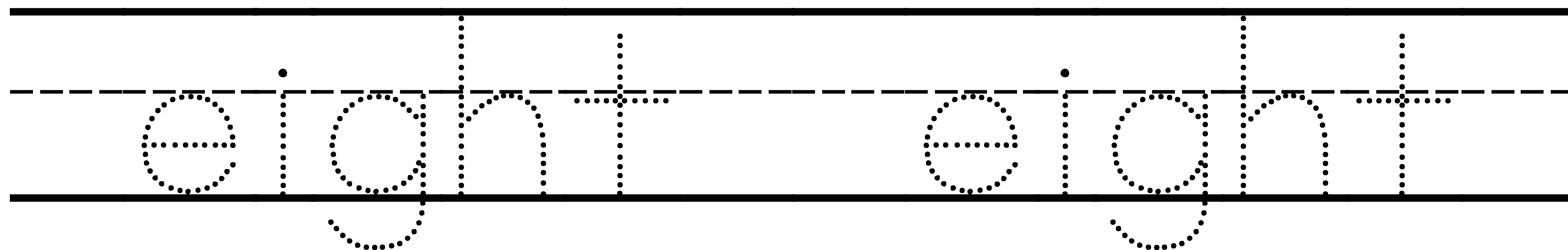
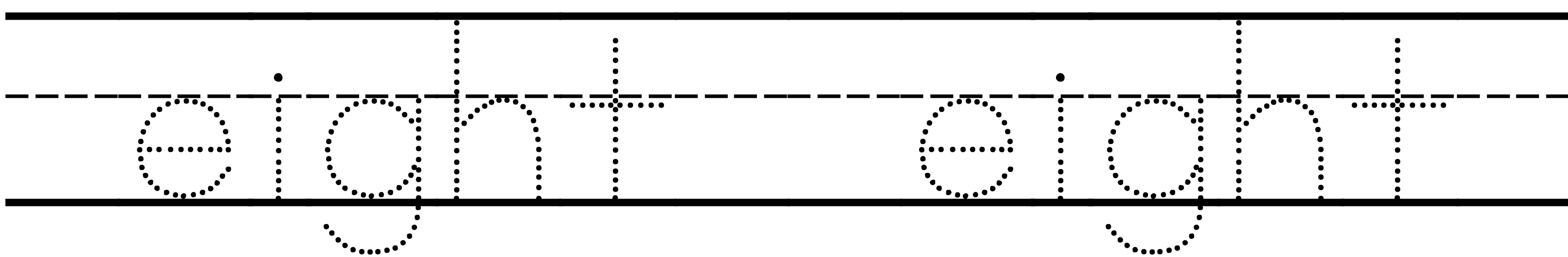
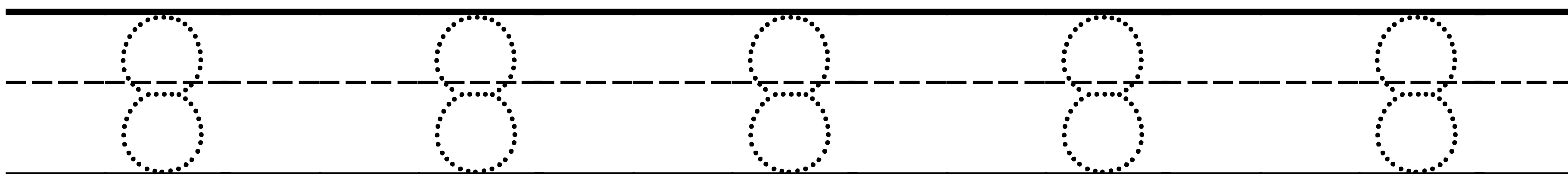
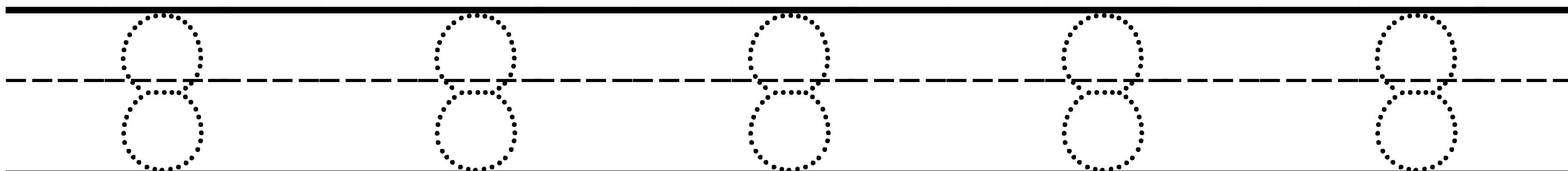
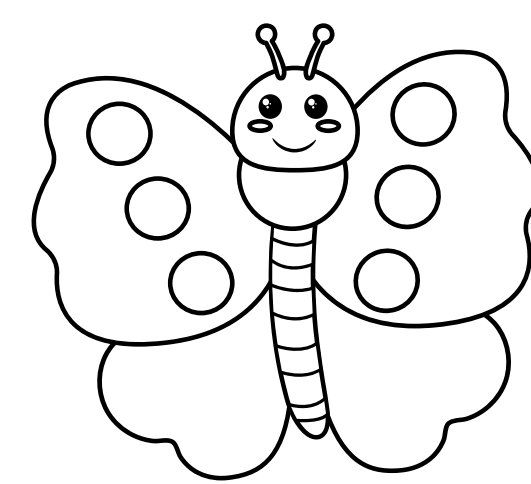
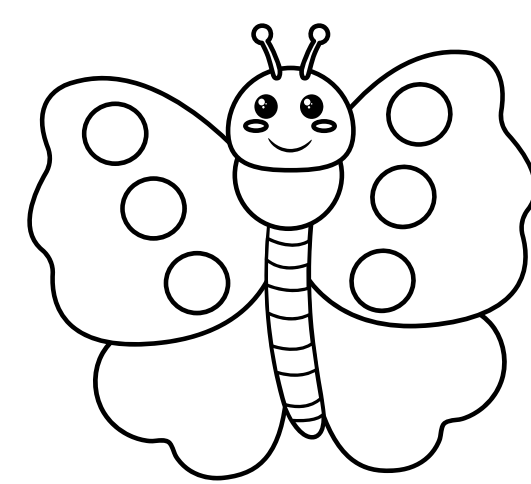



NUMBER TRACING WORKSHEET

9

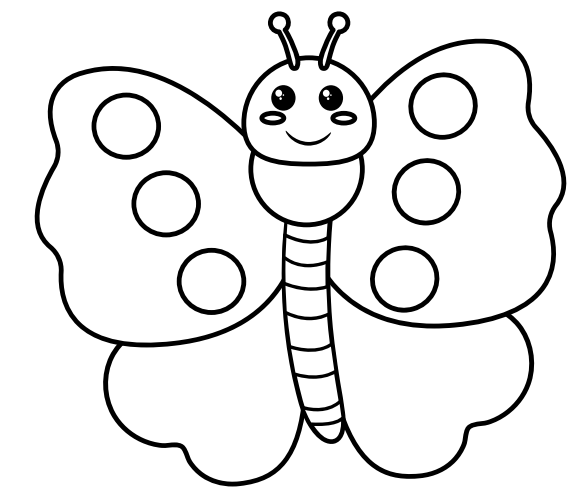
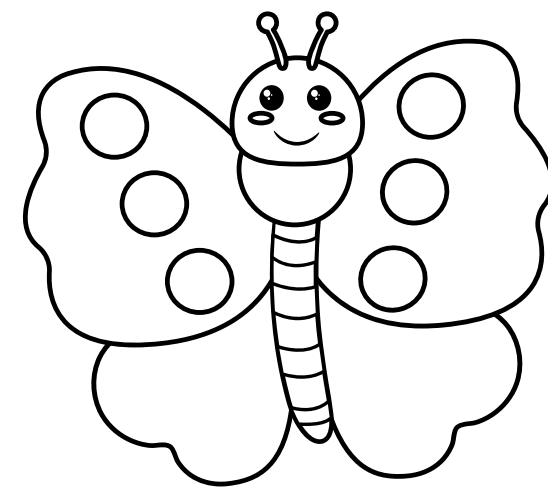
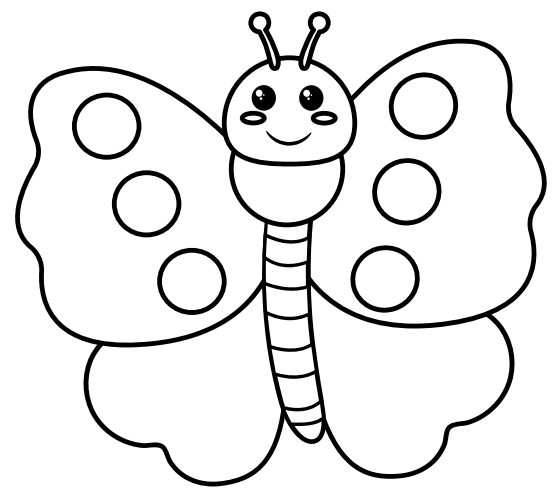
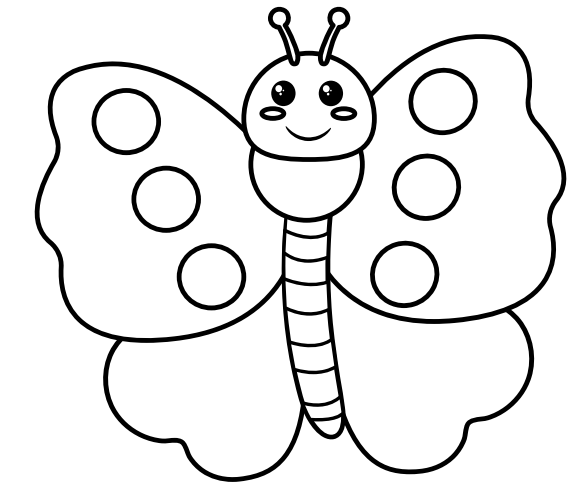
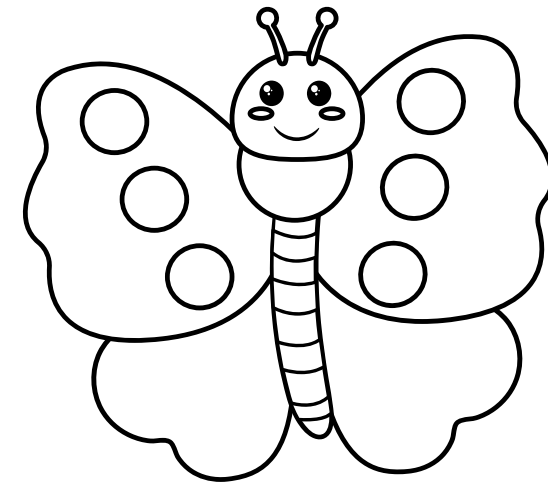
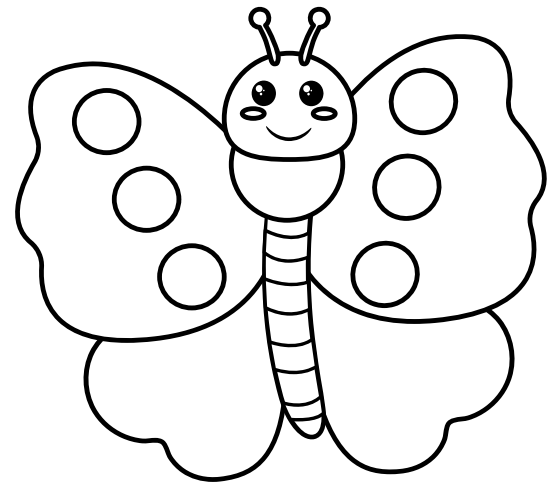

nine

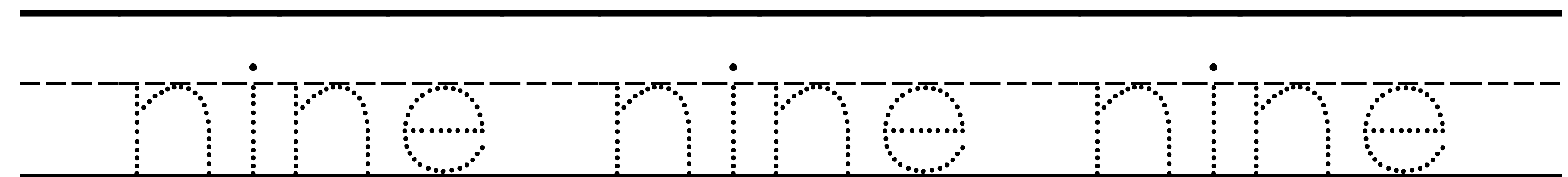
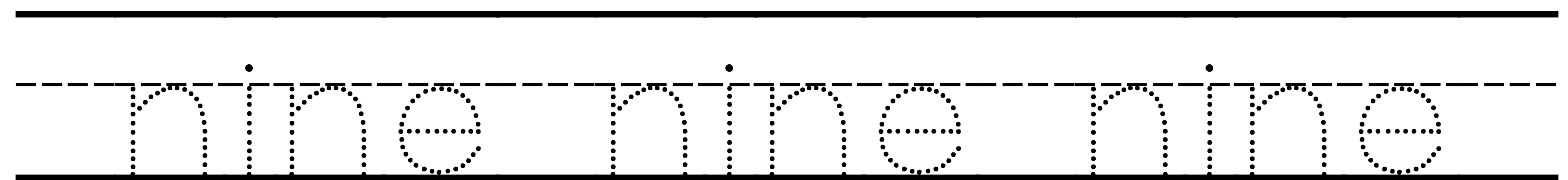
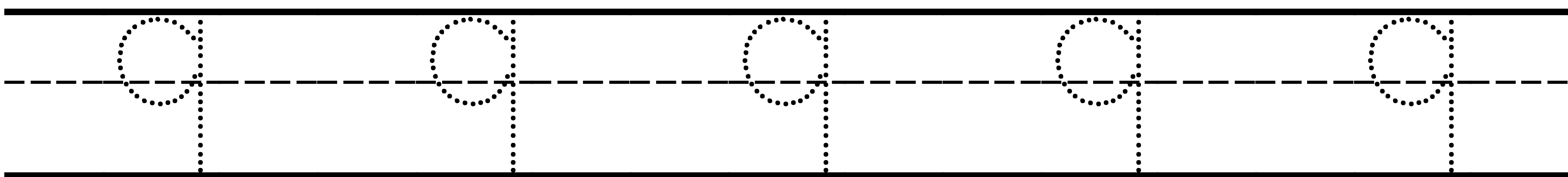
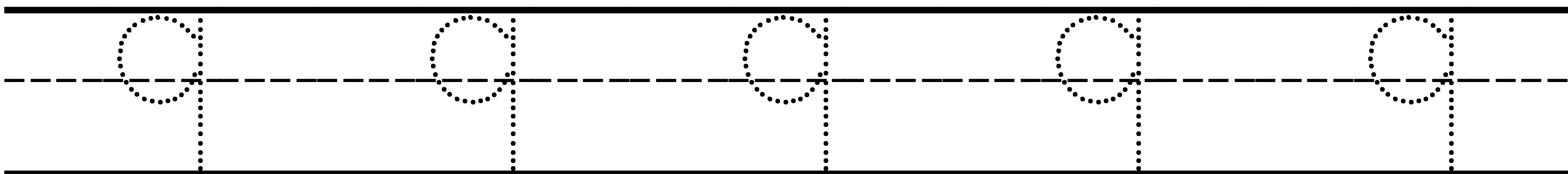
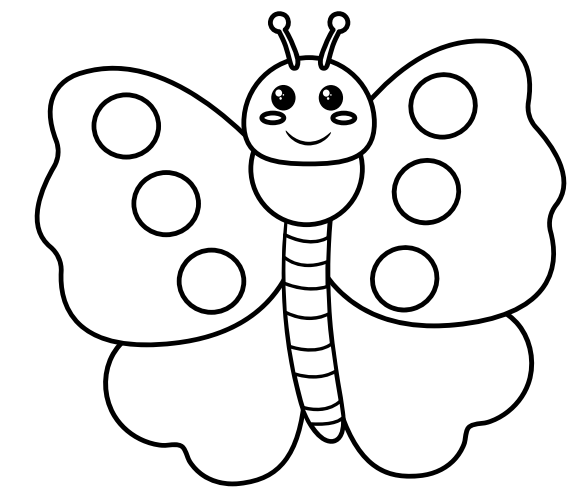
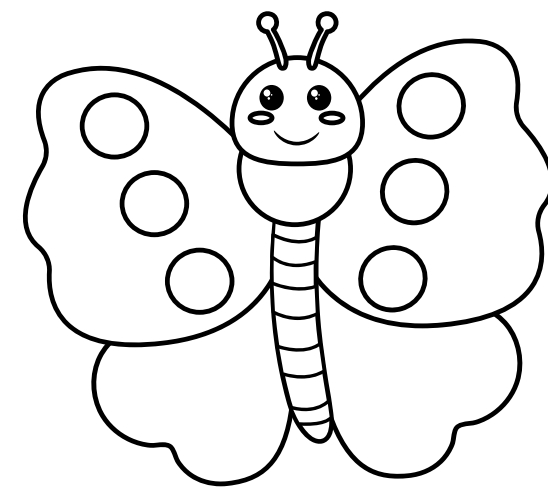
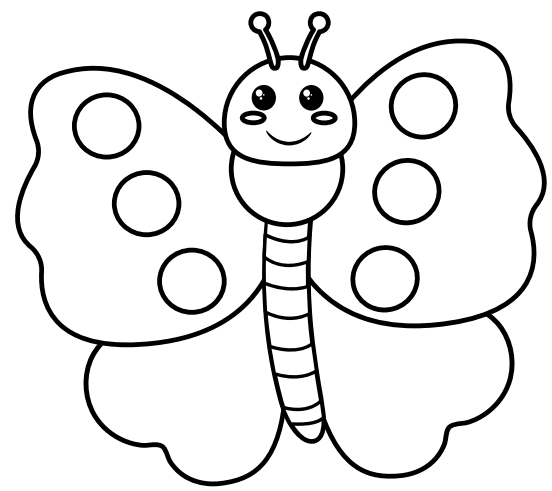



NUMBER TRACING WORKSHEET

10

ten

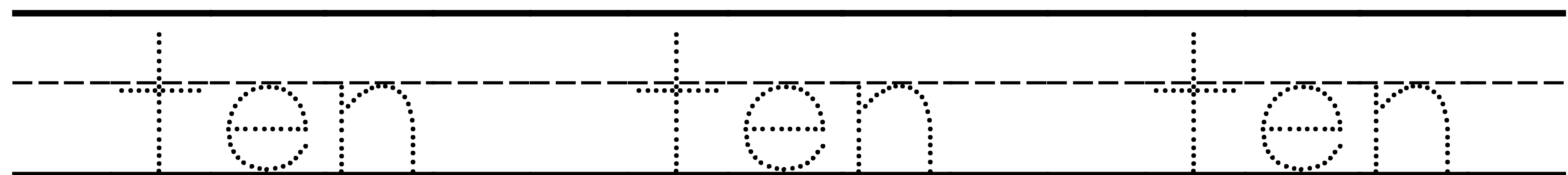
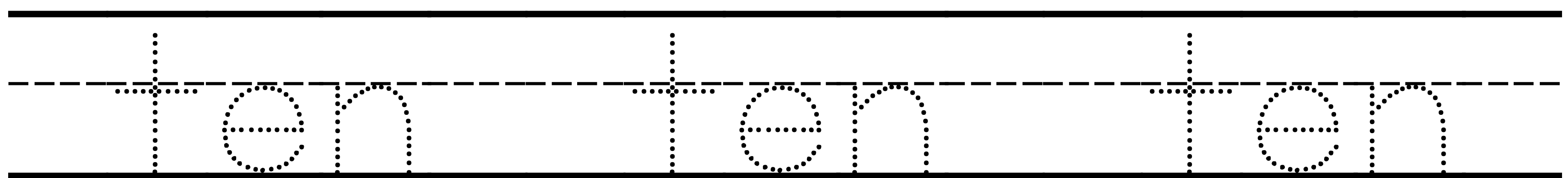
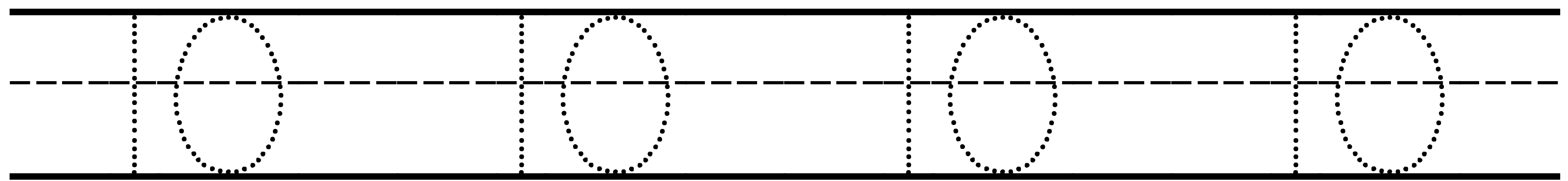
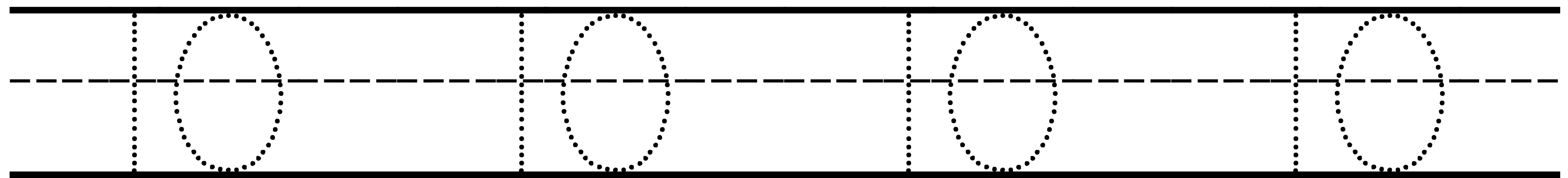
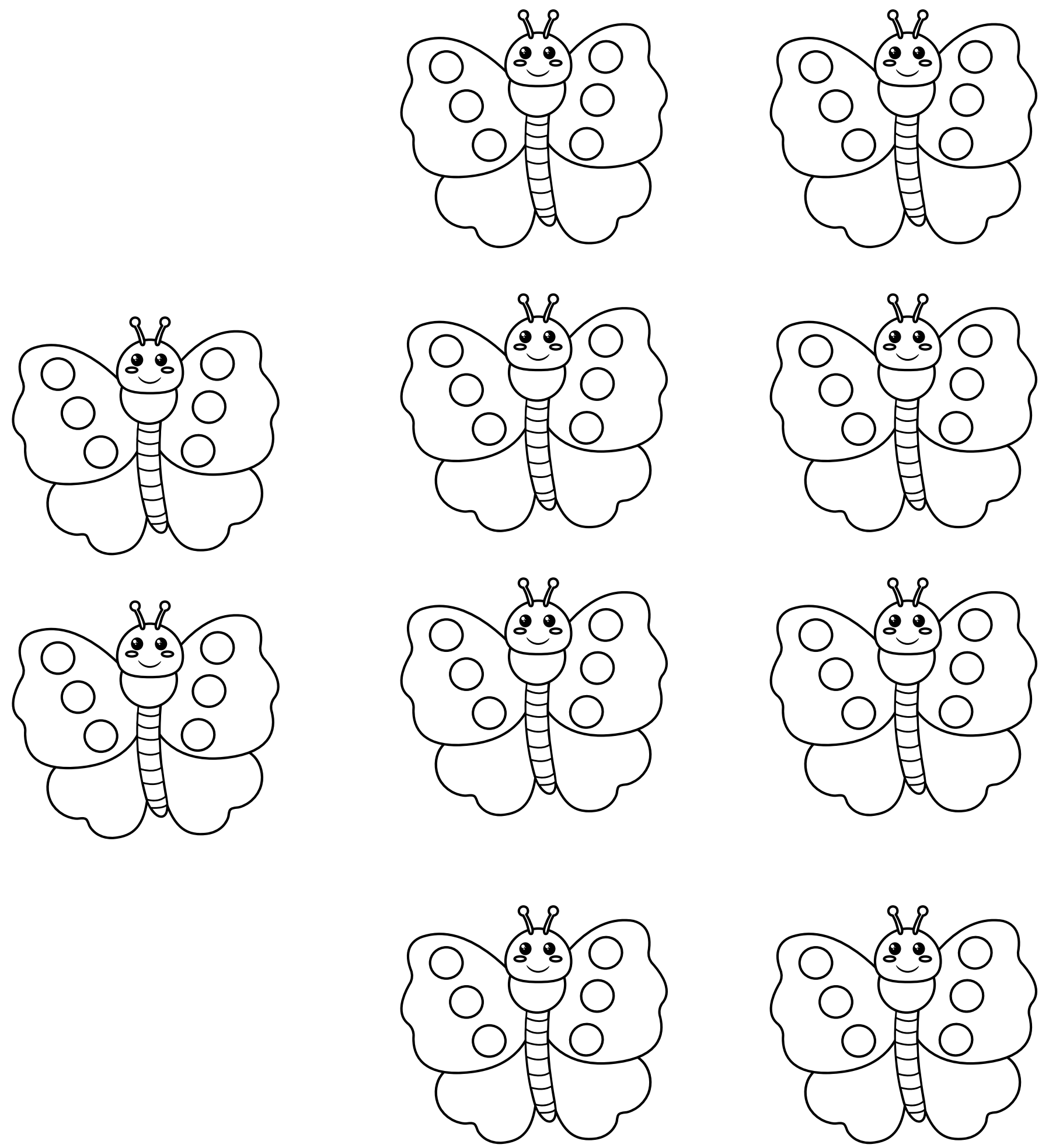



ORDERING NUMBERS

Cut and glue in order.

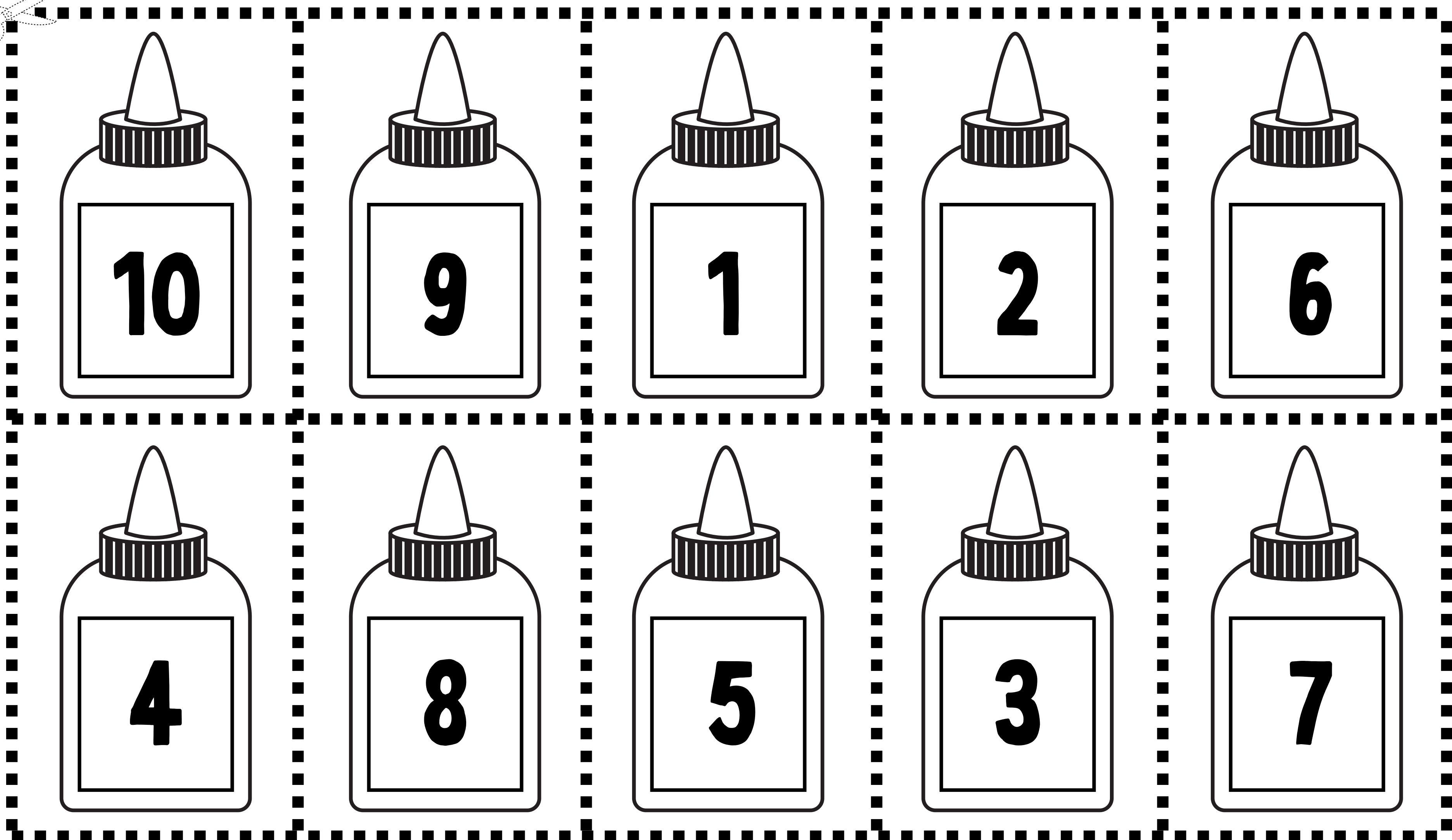
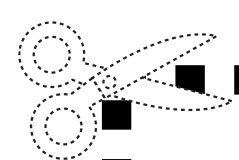



ORDERING NUMBERS

Cut and glue in order.

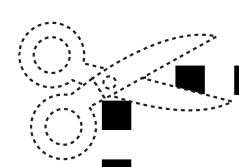







1	7	8	4	3
10	5	6	2	9

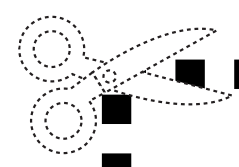

ORDERING NUMBERS

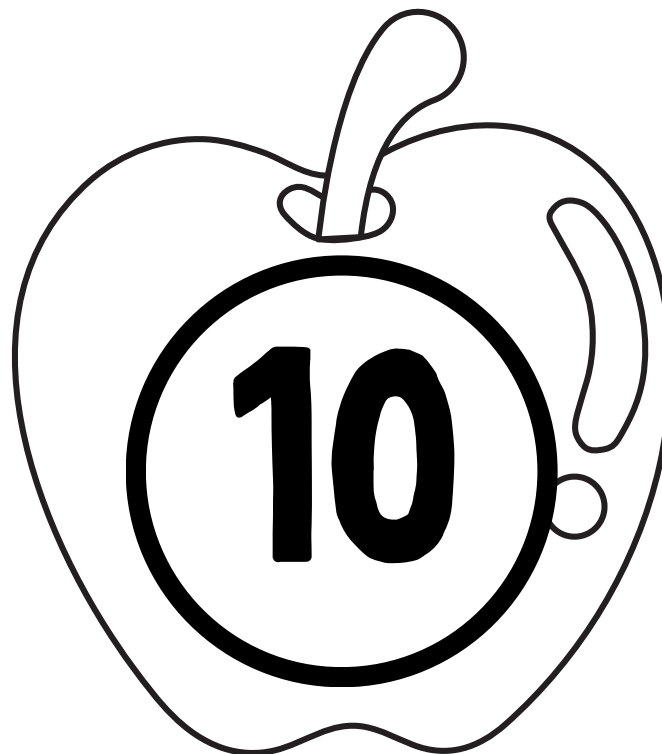
Cut and glue in order.



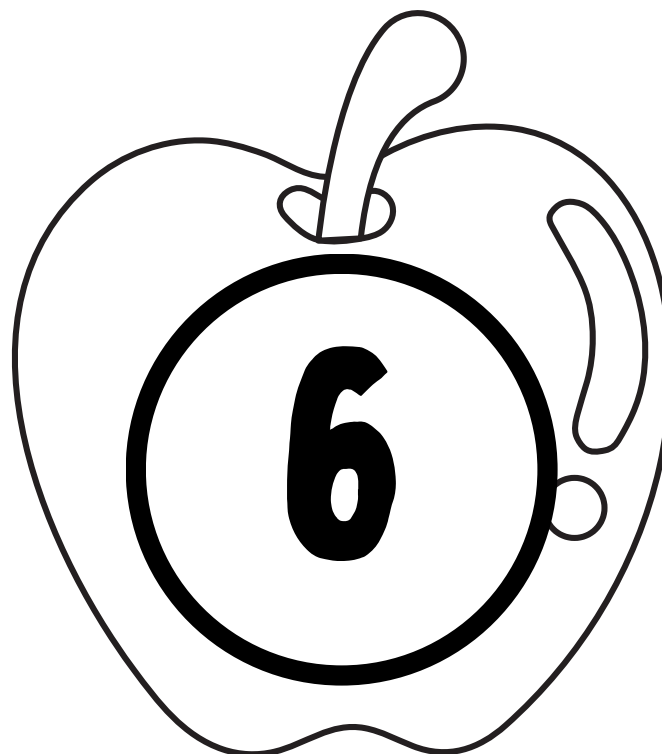
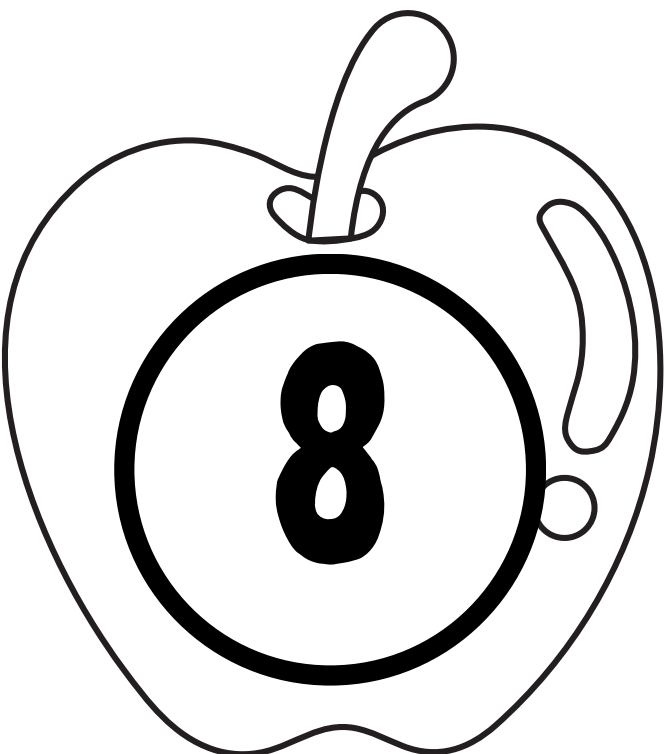
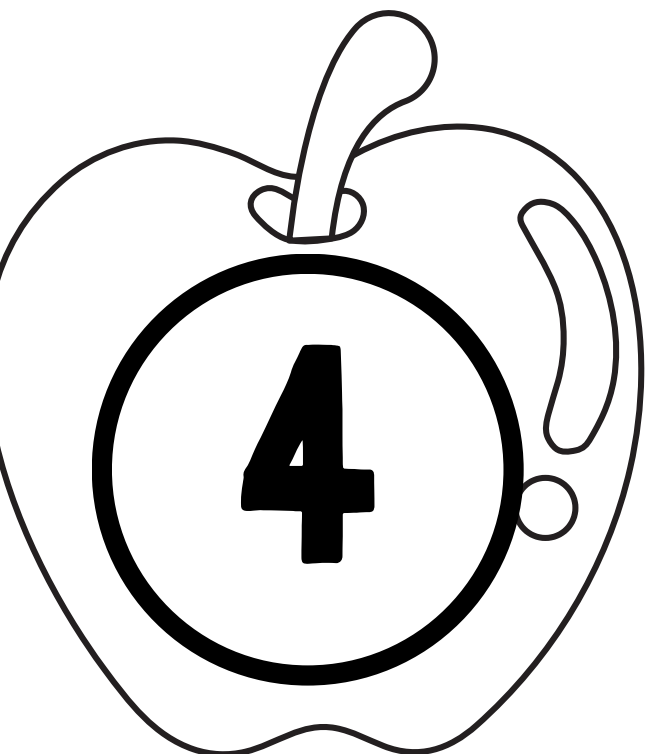

ORDERING NUMBERS

Cut and glue in order.



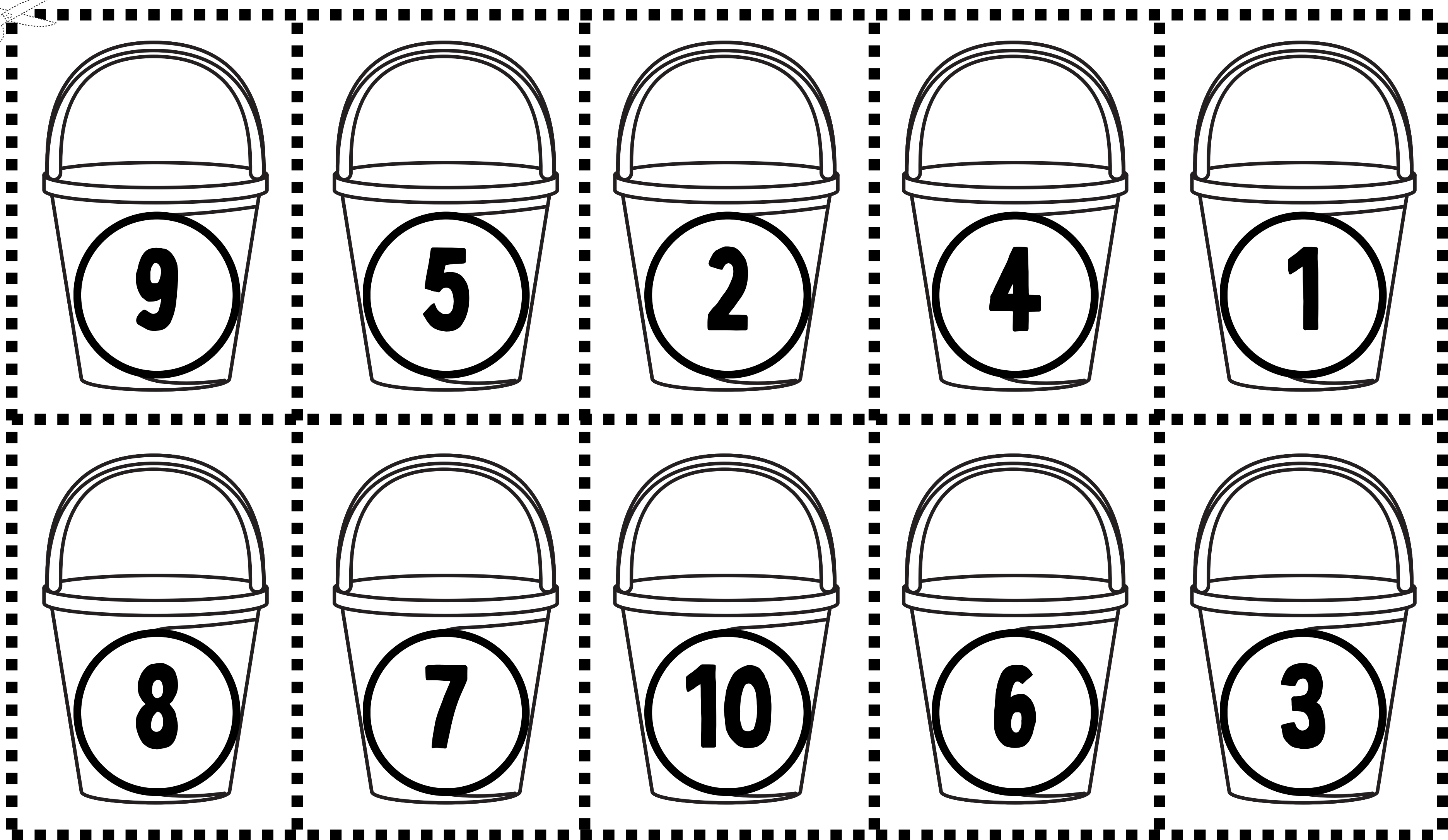

ORDERING NUMBERS

Cut and glue in order.

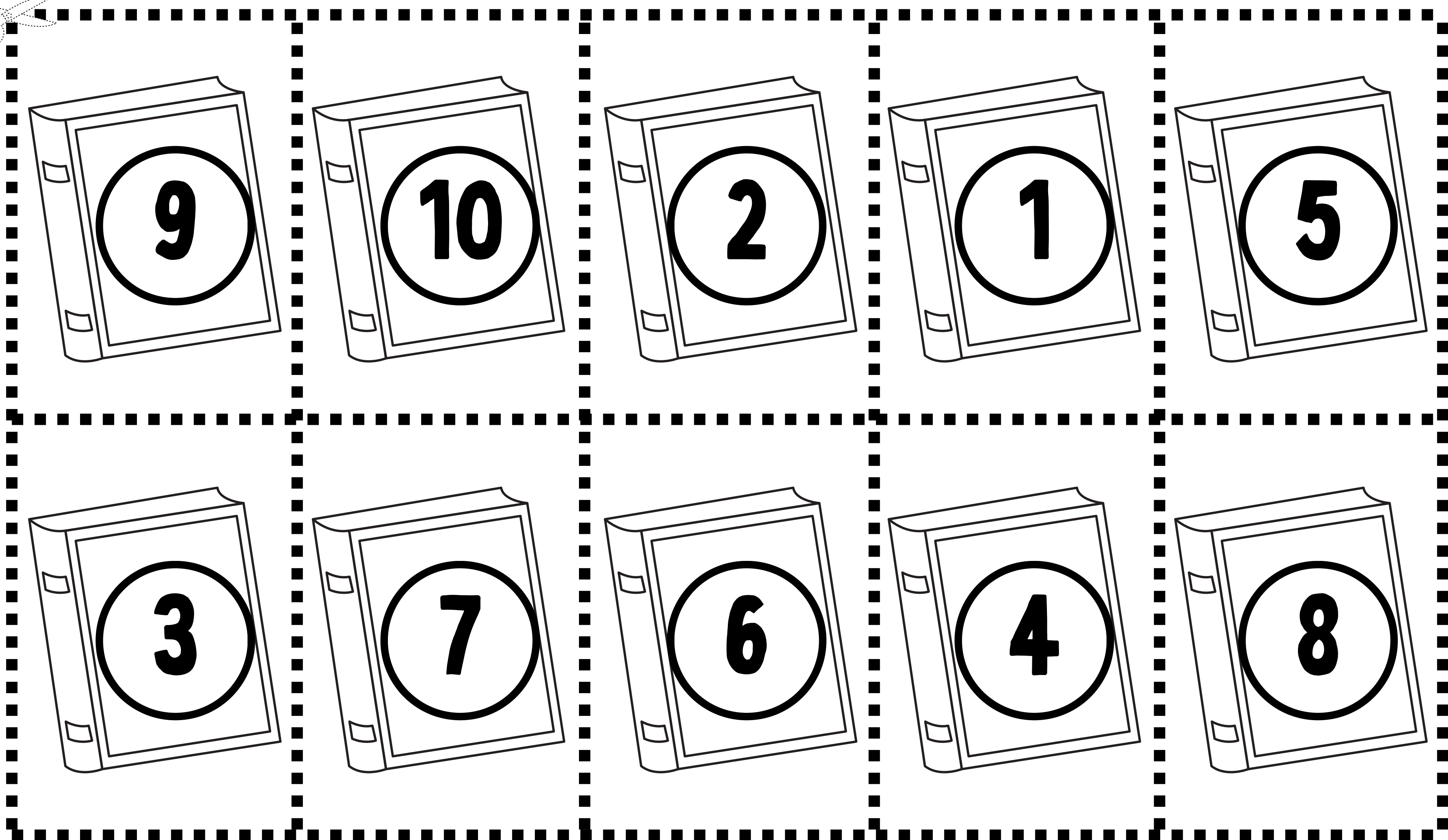



ORDERING NUMBERS

Cut and glue in order.

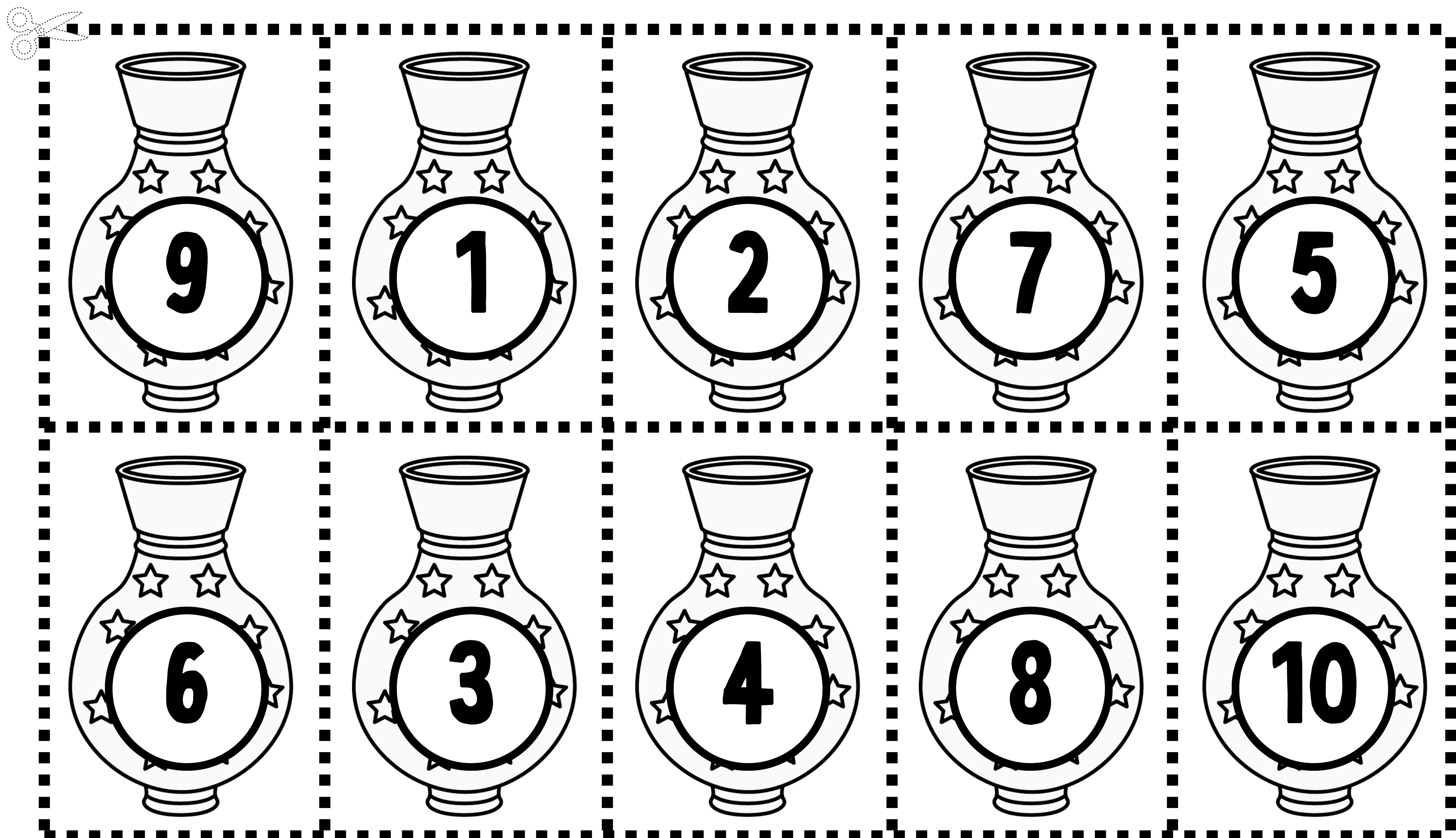



ORDERING NUMBERS

Cut and glue in order.

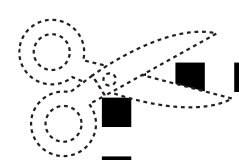

1	3	5	7	9
2	4	6	8	10



ORDERING NUMBERS

Cut and glue in order.

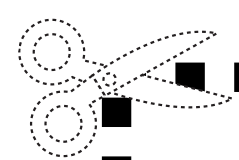







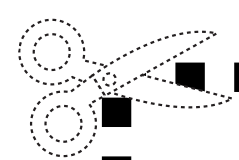



ORDERING NUMBERS

Cut and glue in order.

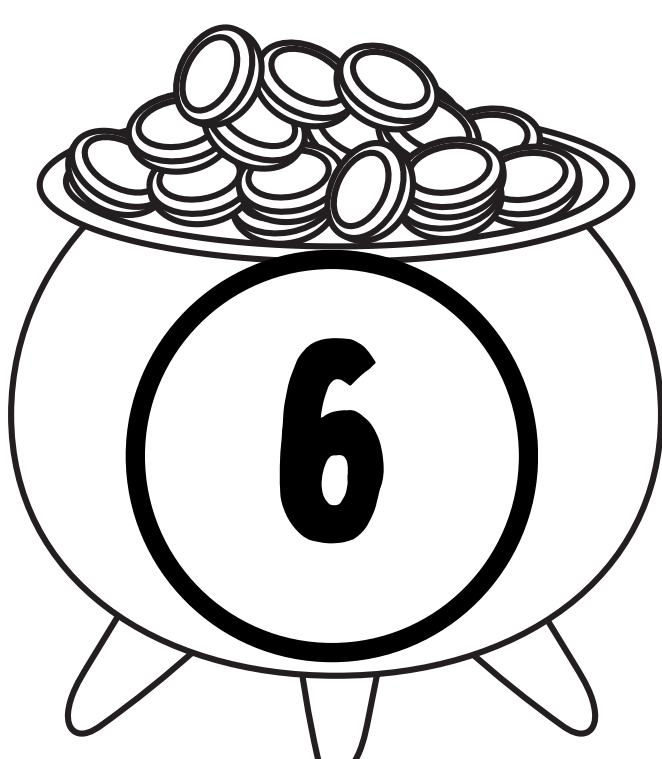

 5	 10	 4	 8	 3
 7	 2	 6	 1	 9



ORDERING NUMBERS

Cut and glue in order.

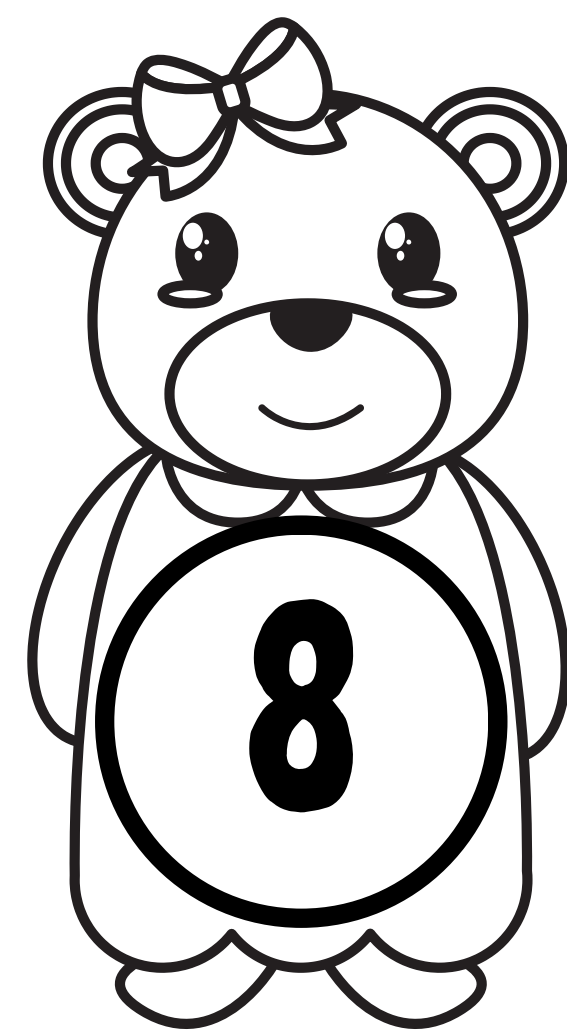
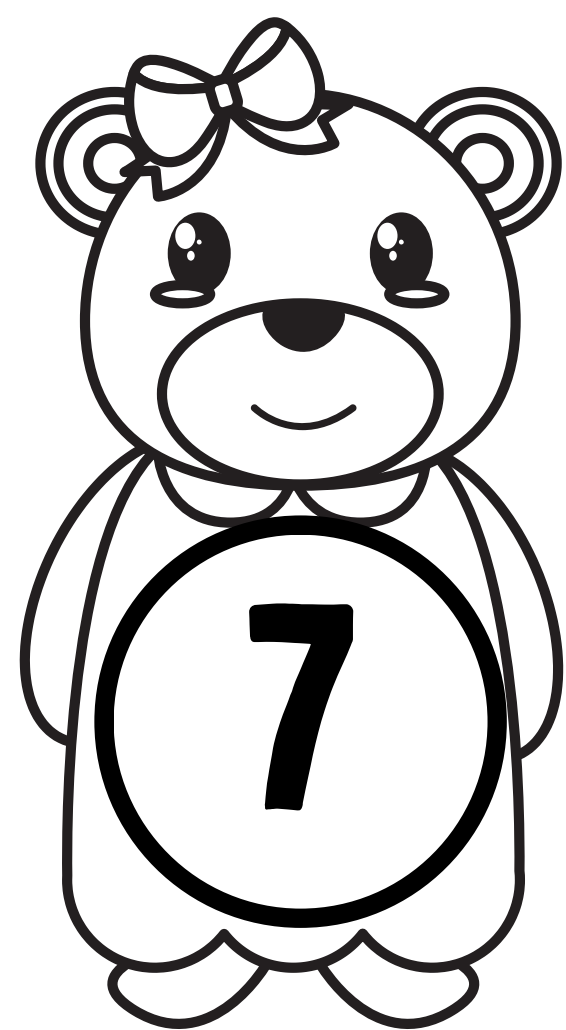
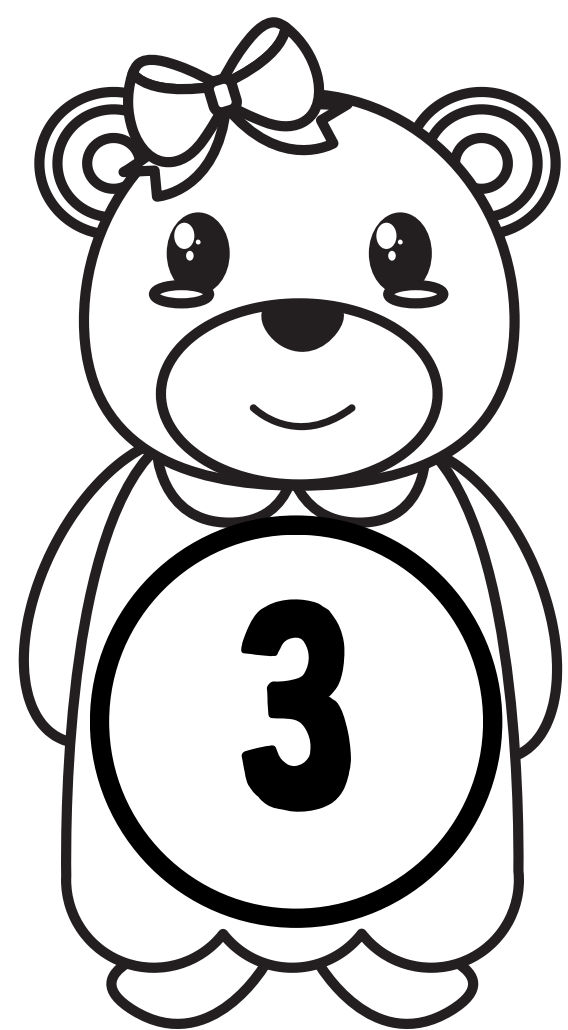
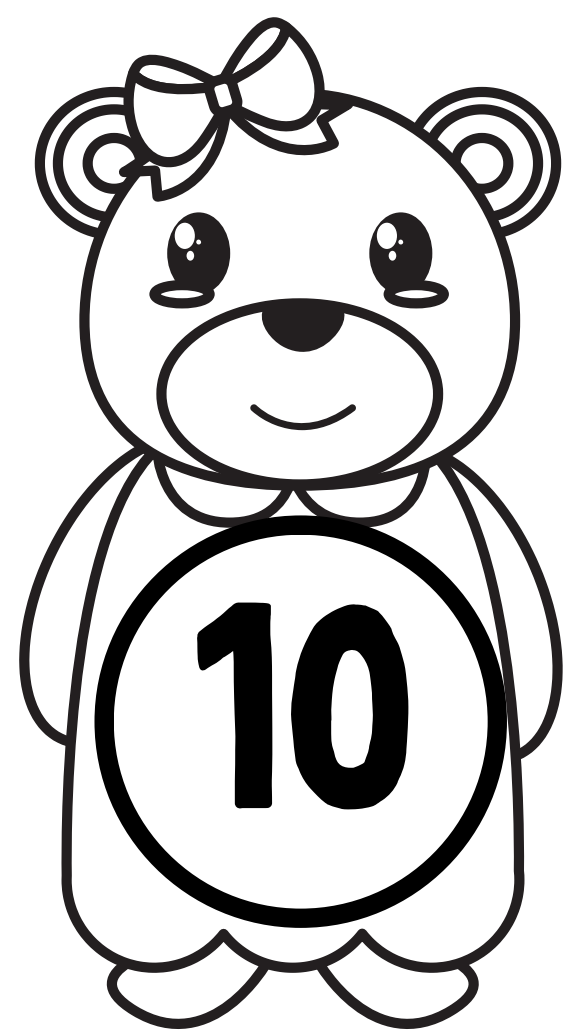
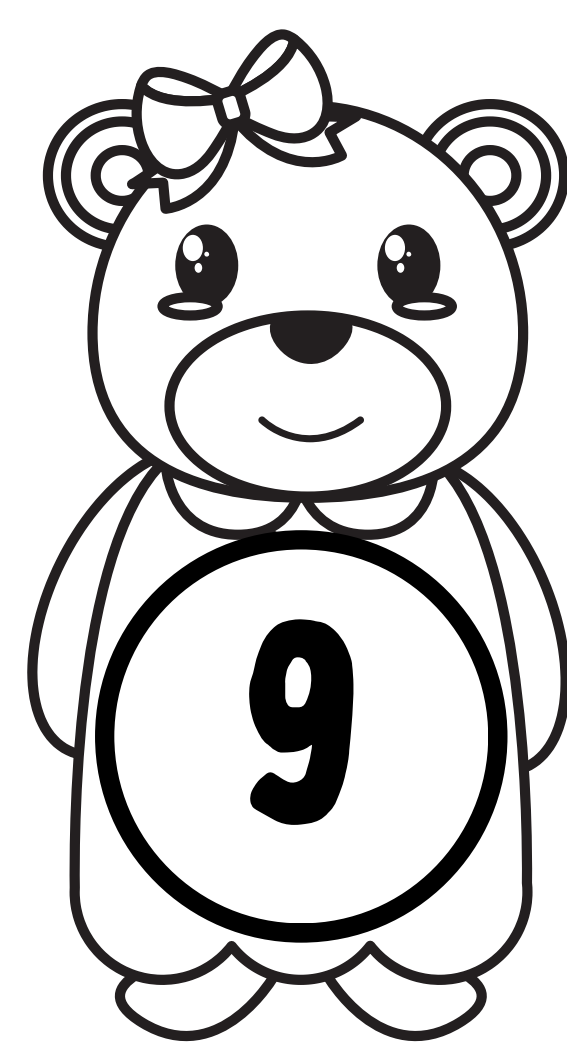
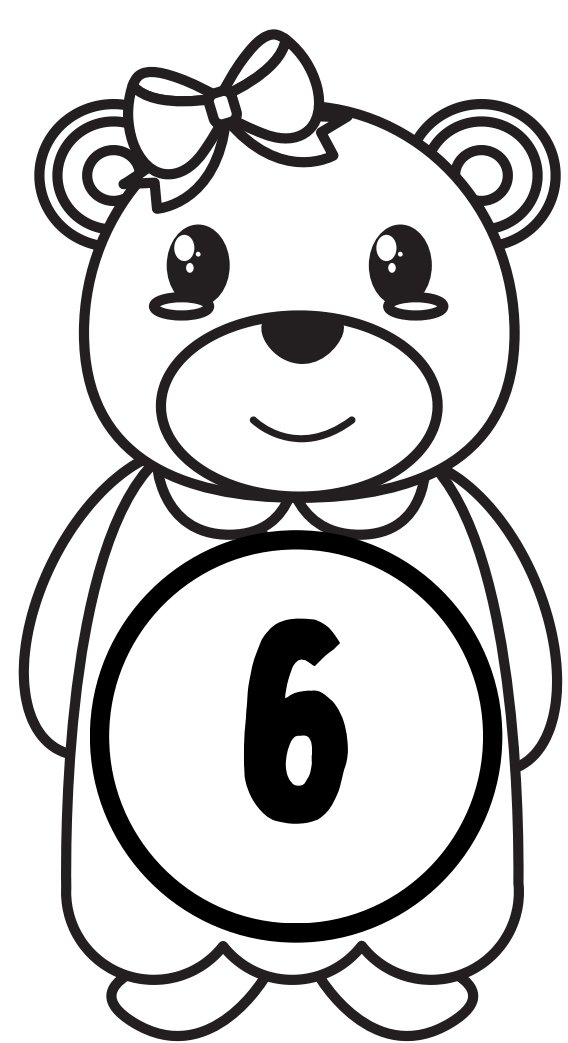
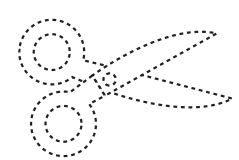

UNDER THE SEA

Activities

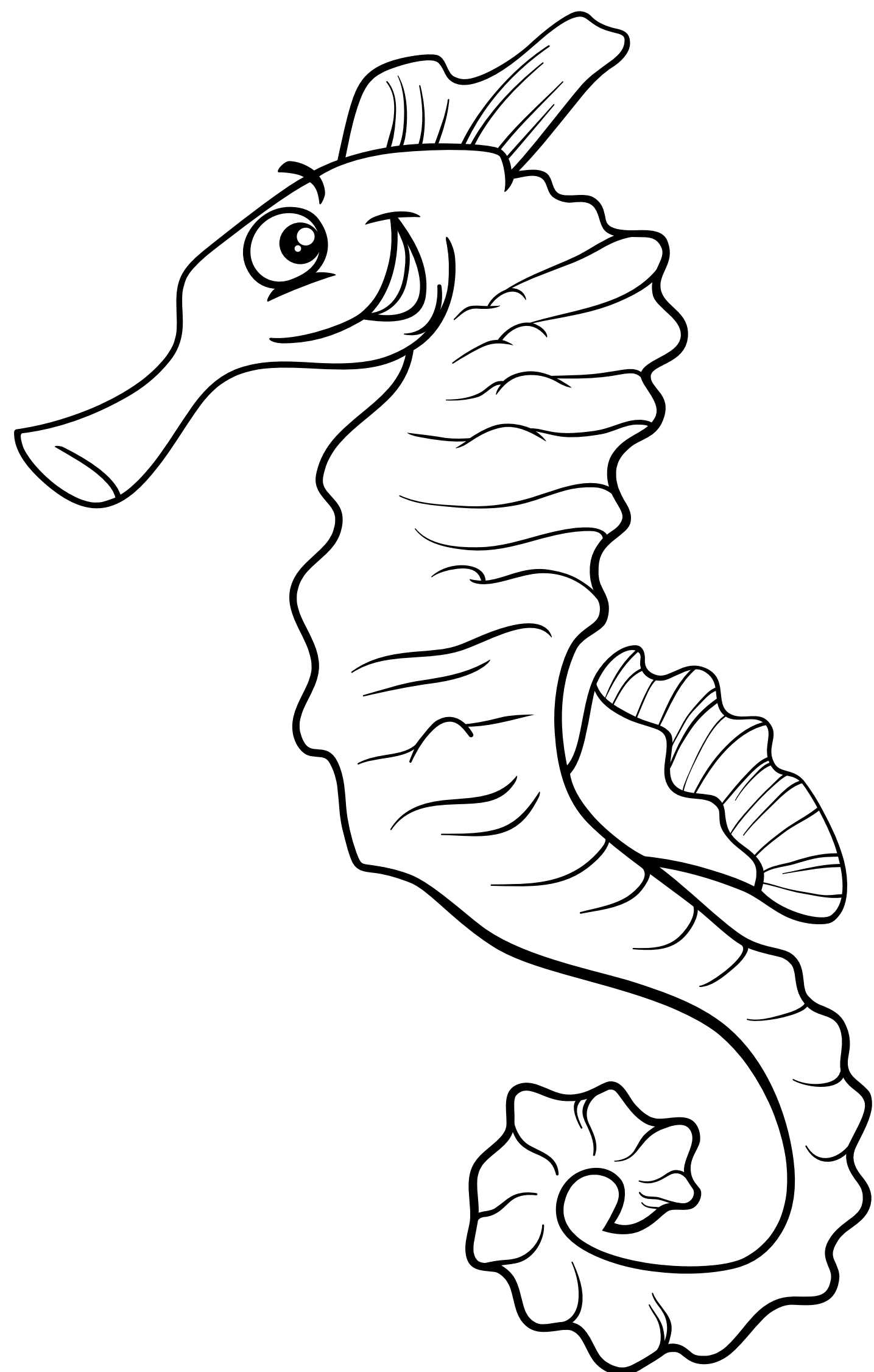
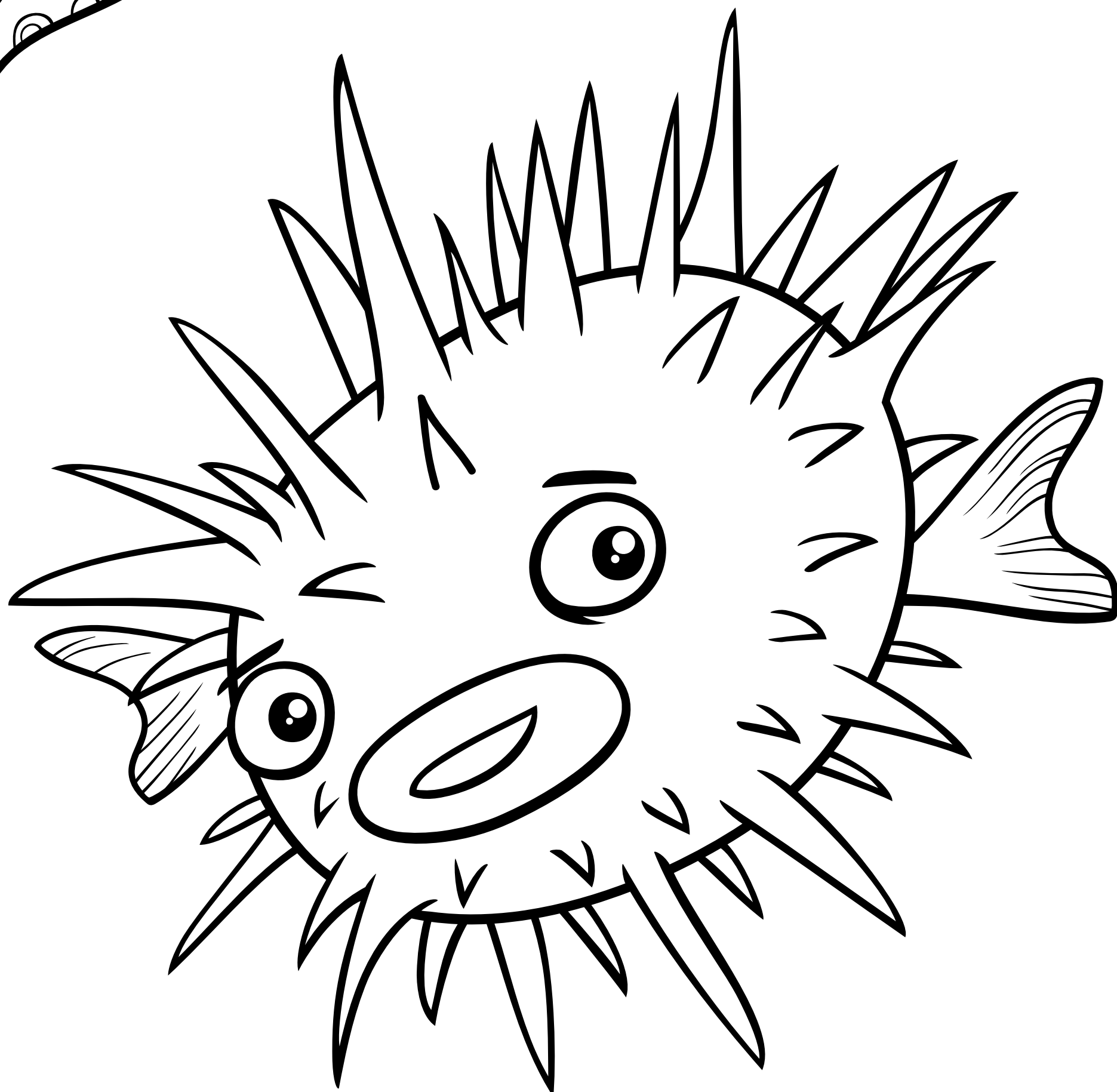
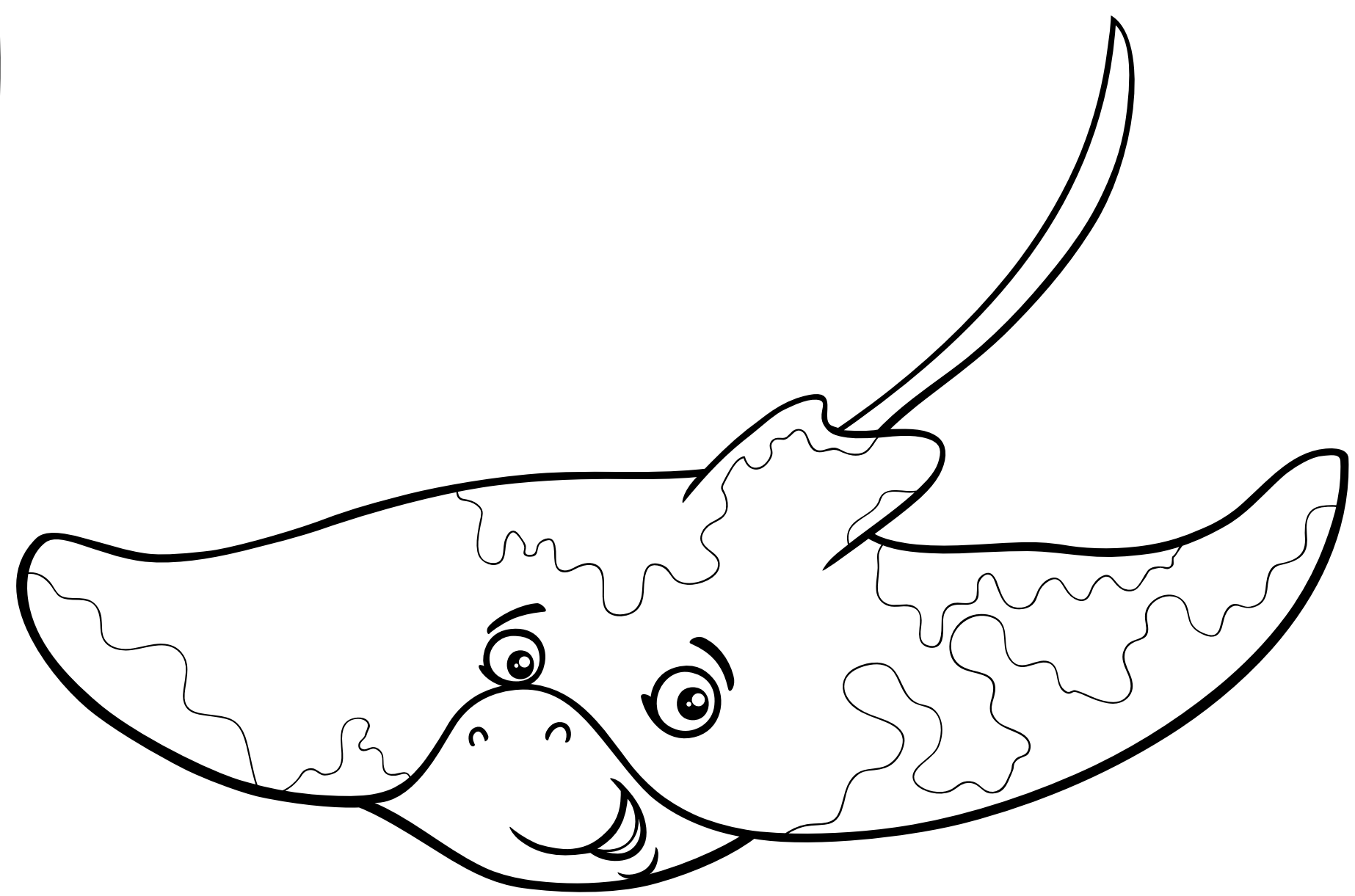
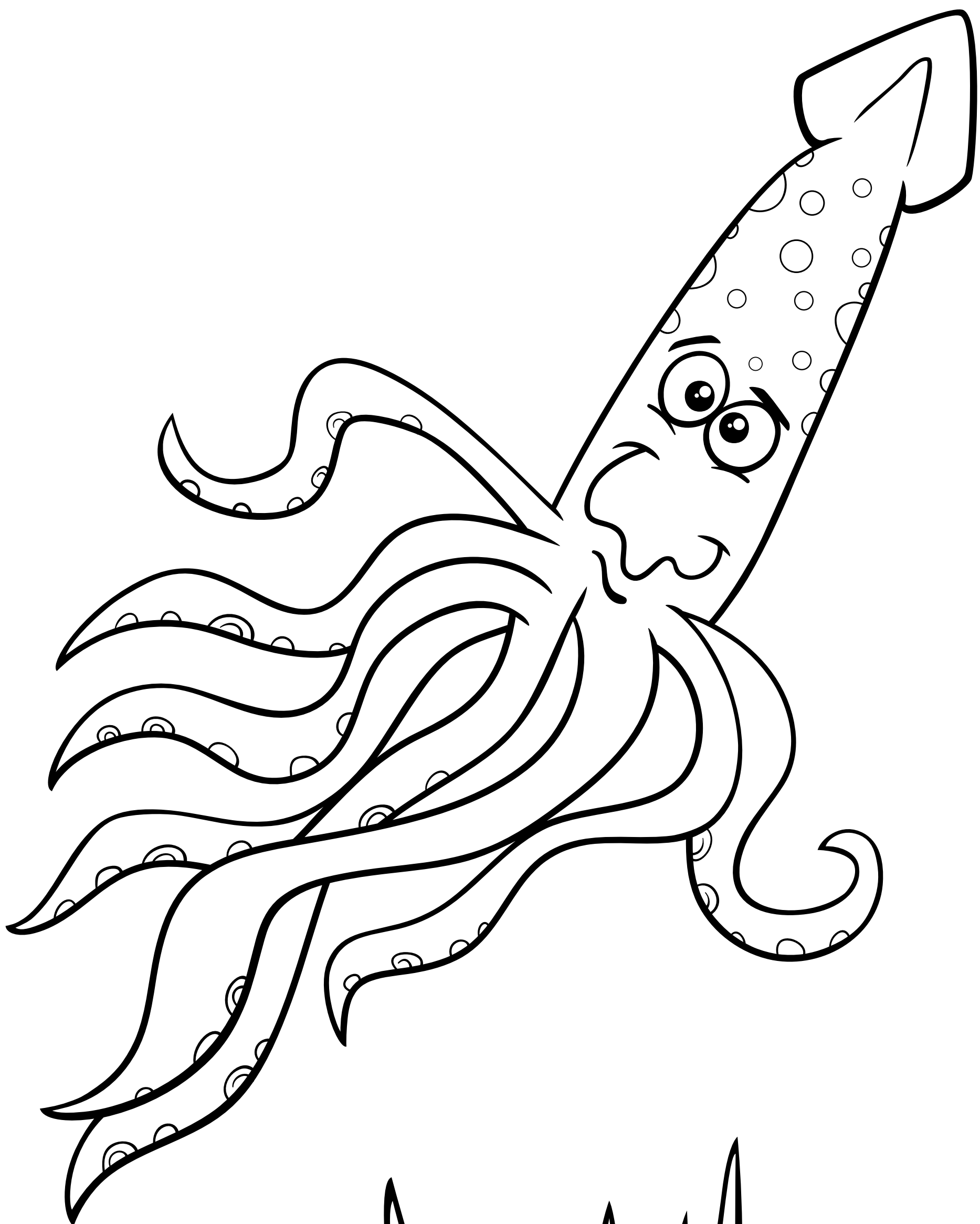

TRACING

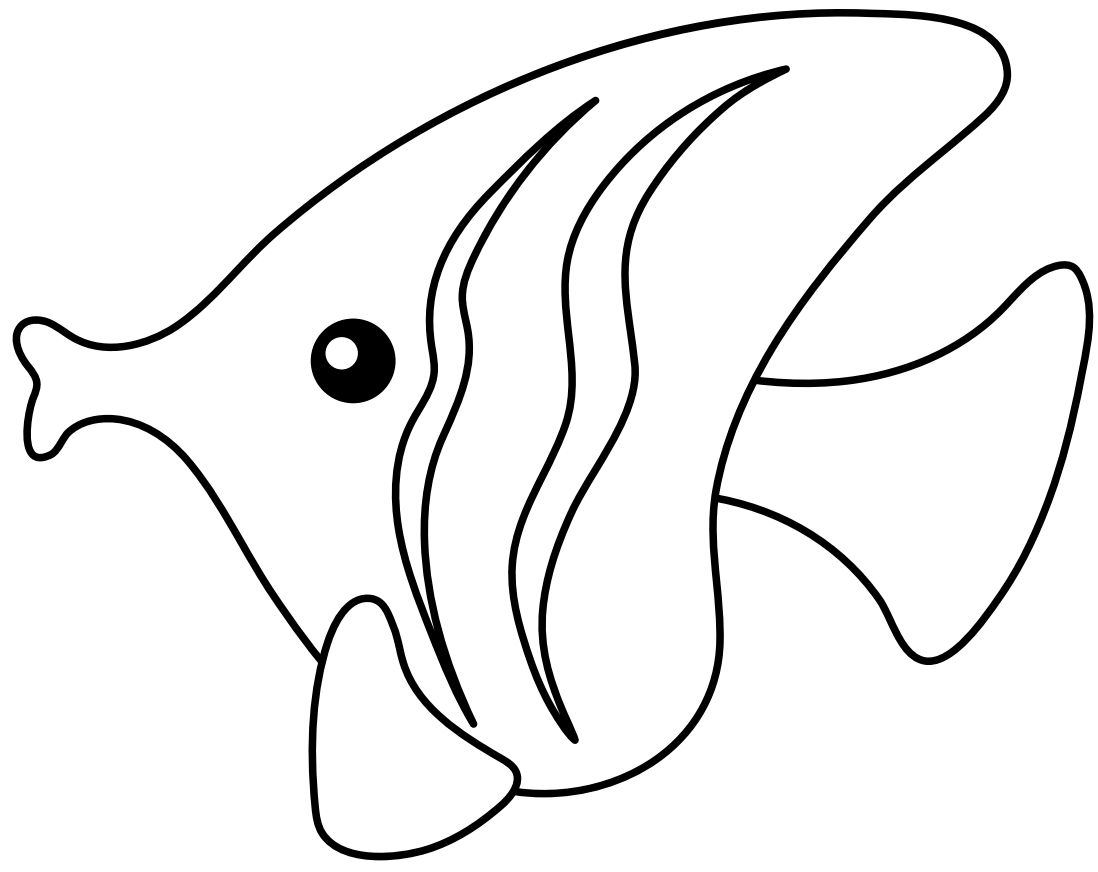

fish

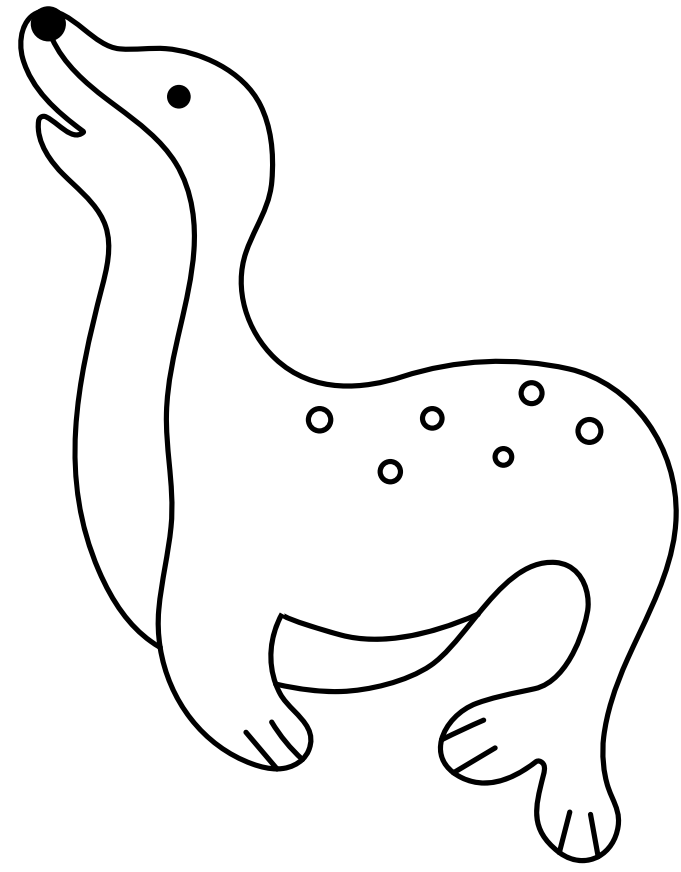

seal

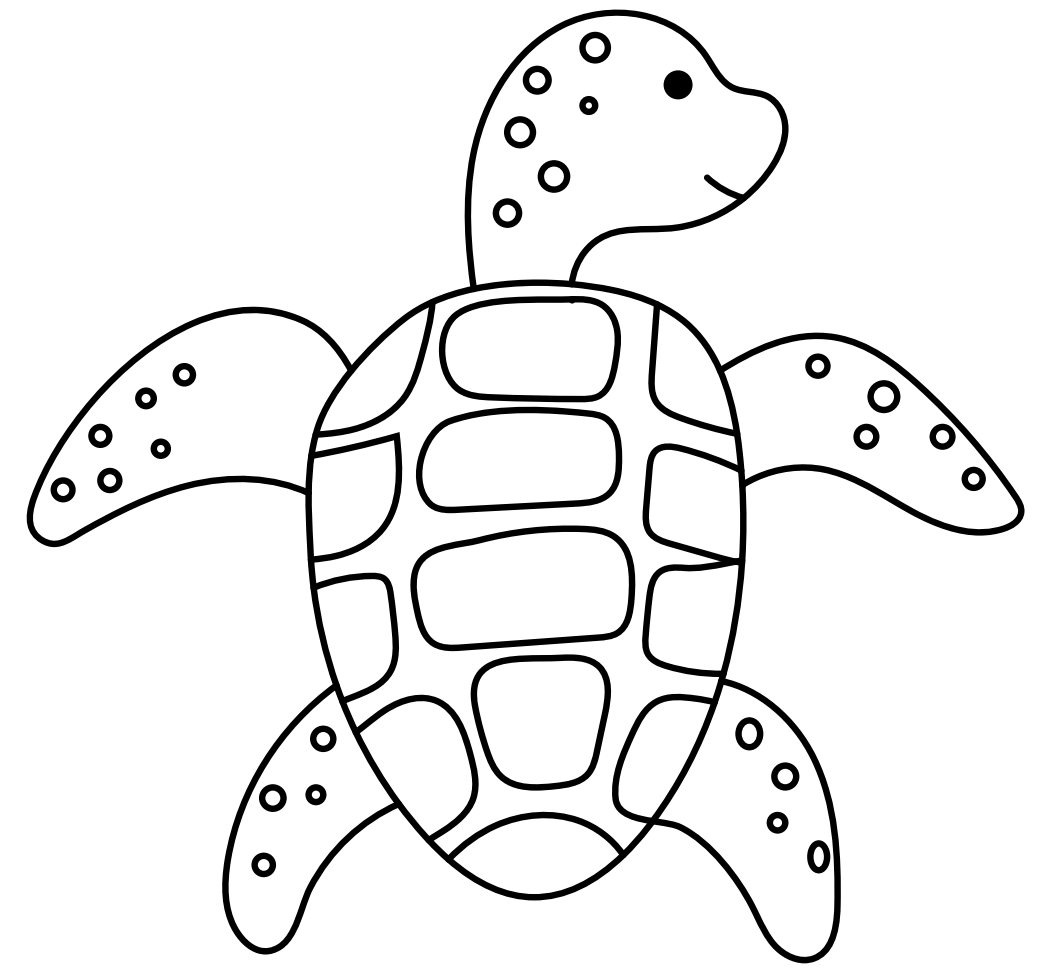

turtle

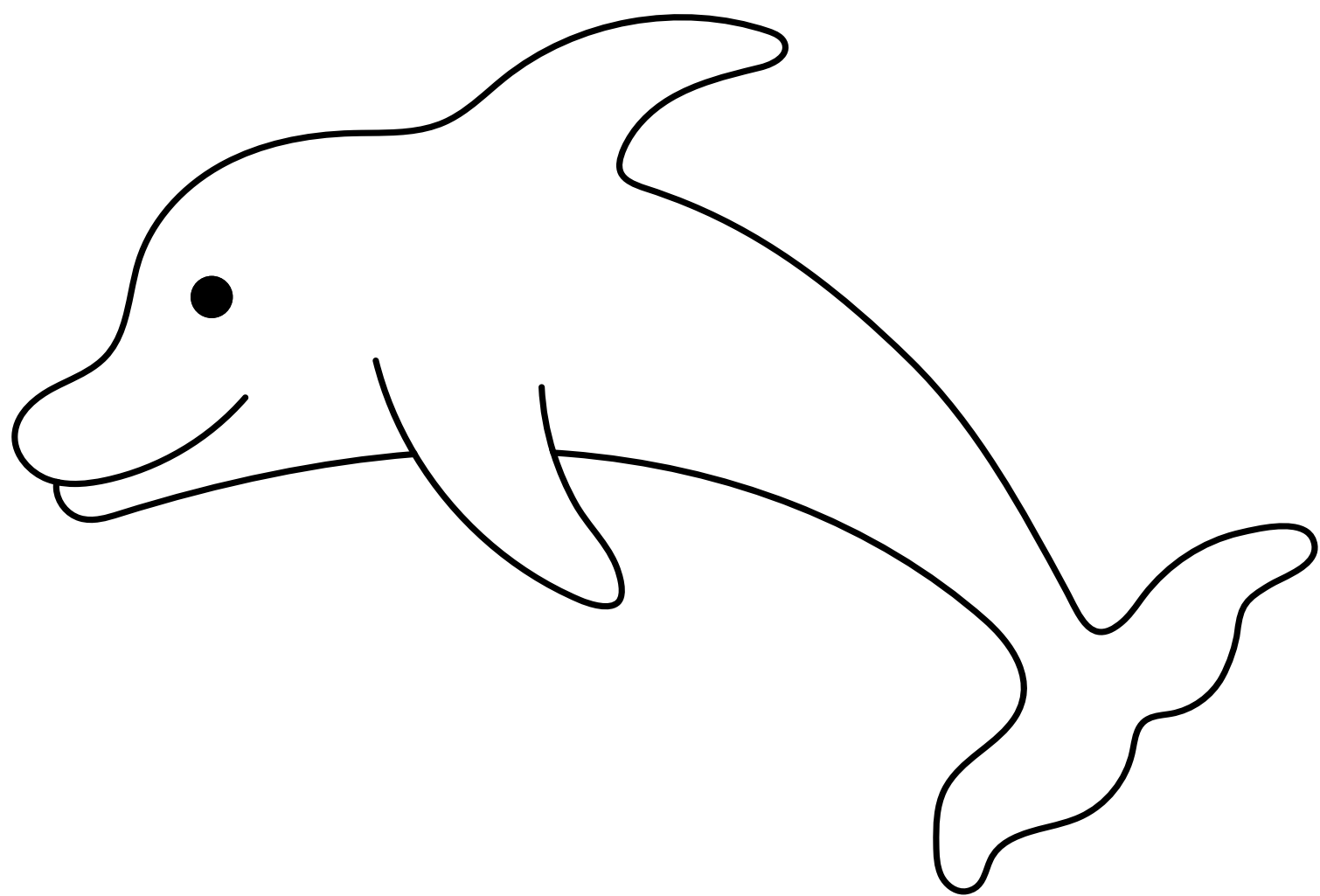

dolphin

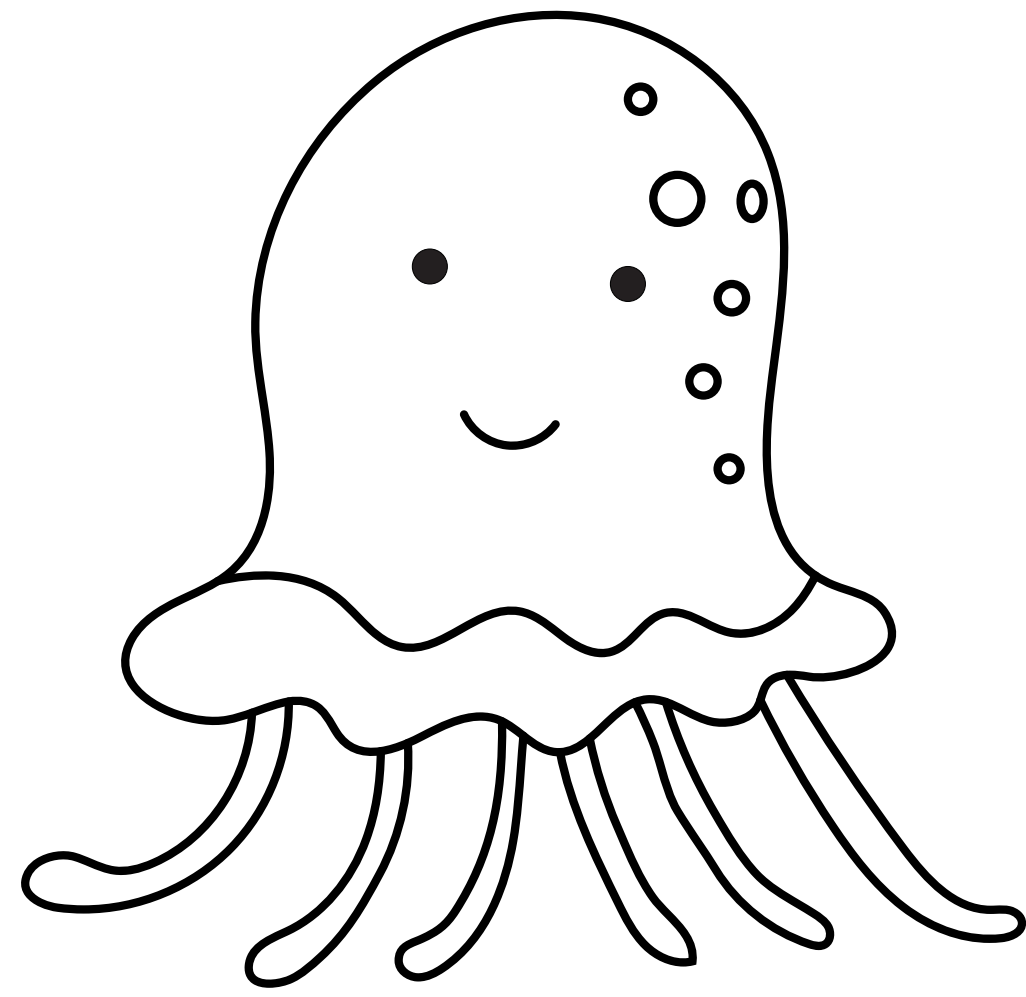

jellyfish

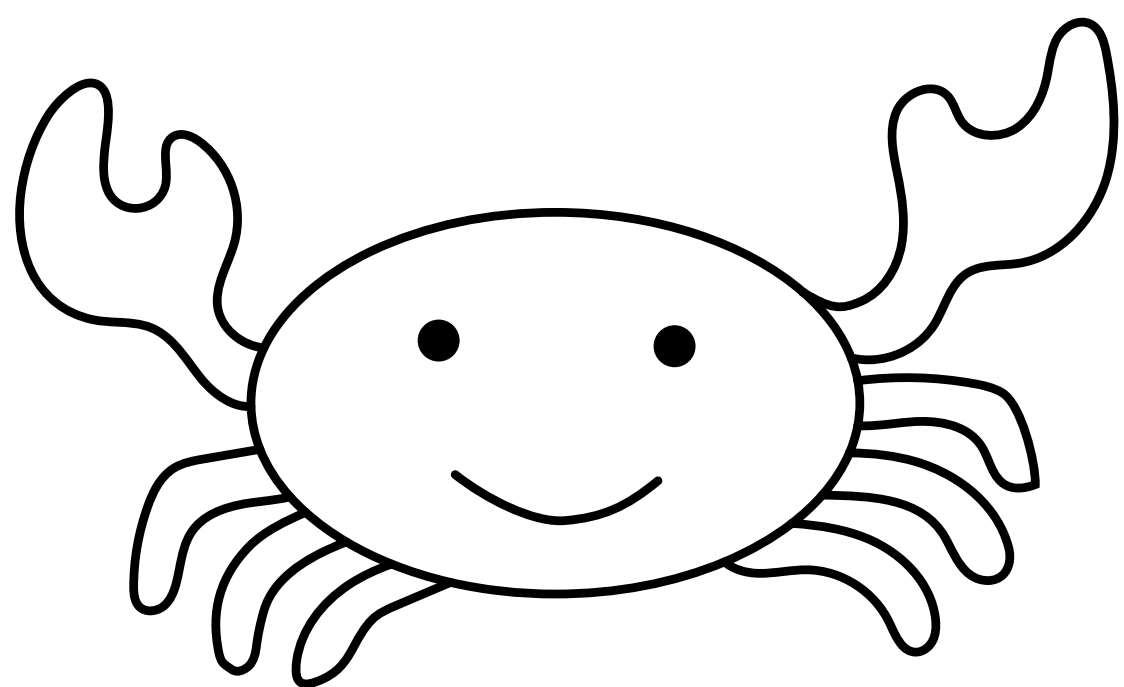

crab

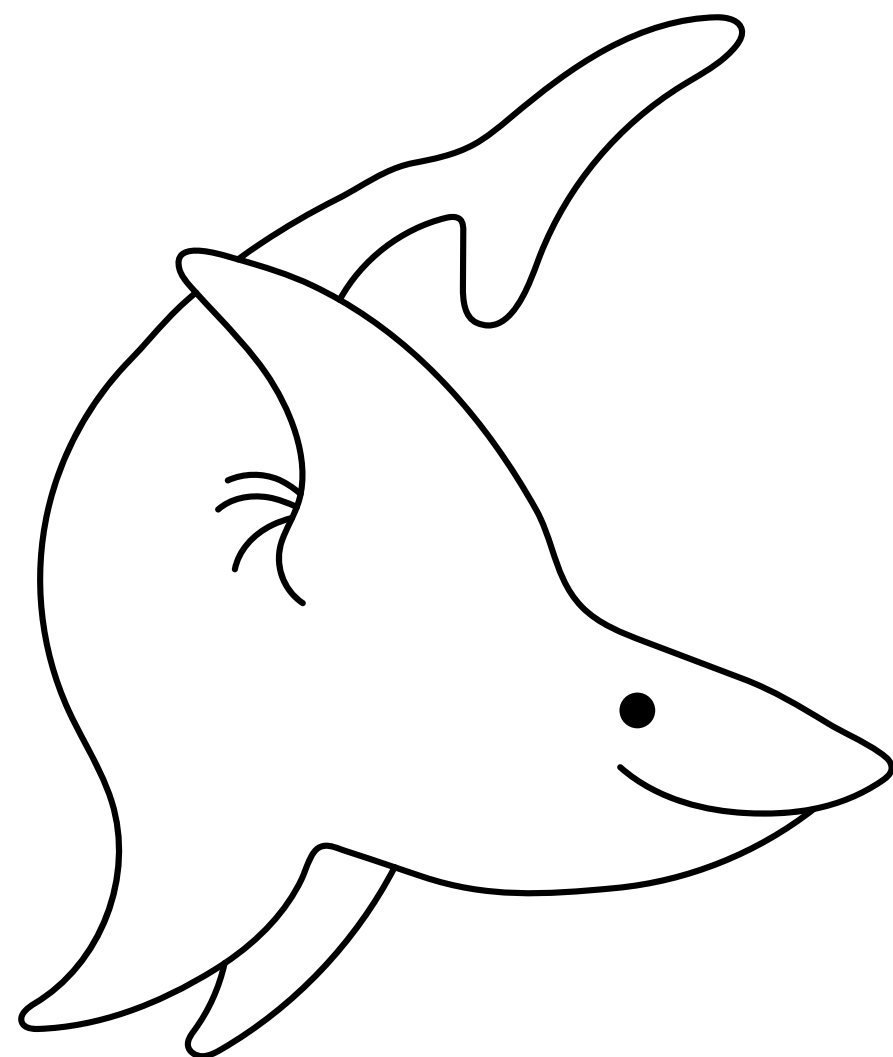

shark



DRAWING

Draw a picture to match each word:

--	--	--

octopus

clam

starfish

--	--	--

whale

coral

shel

FIND, COLOUR, COUNT

Tally the total number of each sea creature in the boxes below:

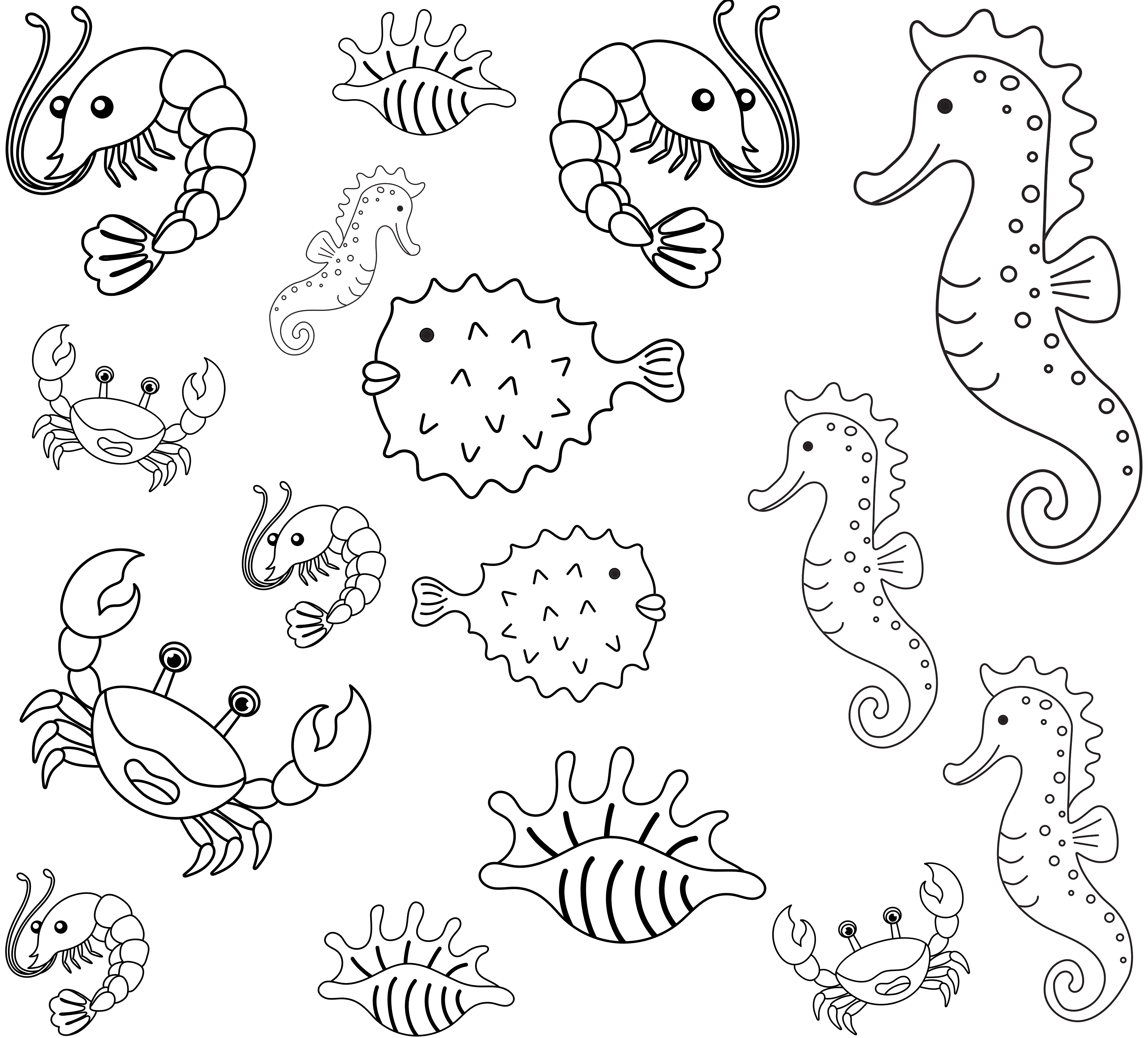

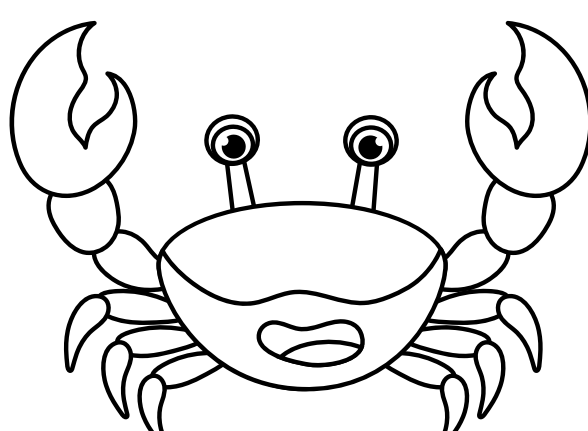
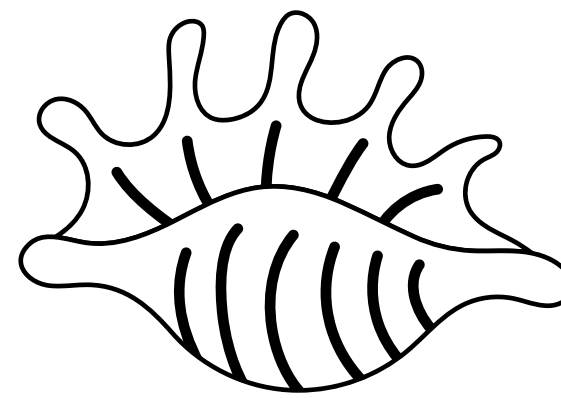
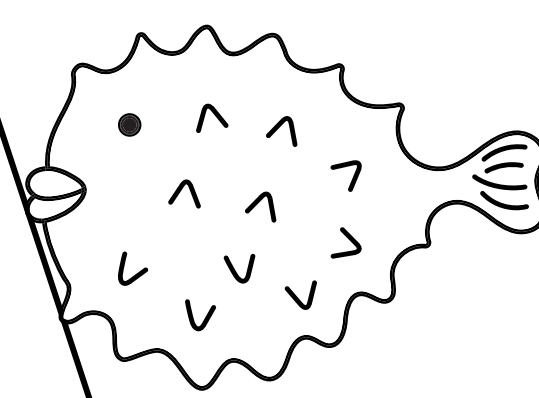
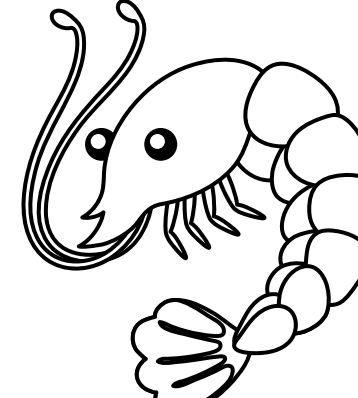
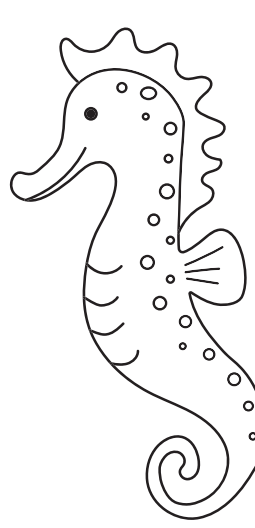

MISSING VOWELS

Fill in the missing vowels for each word:

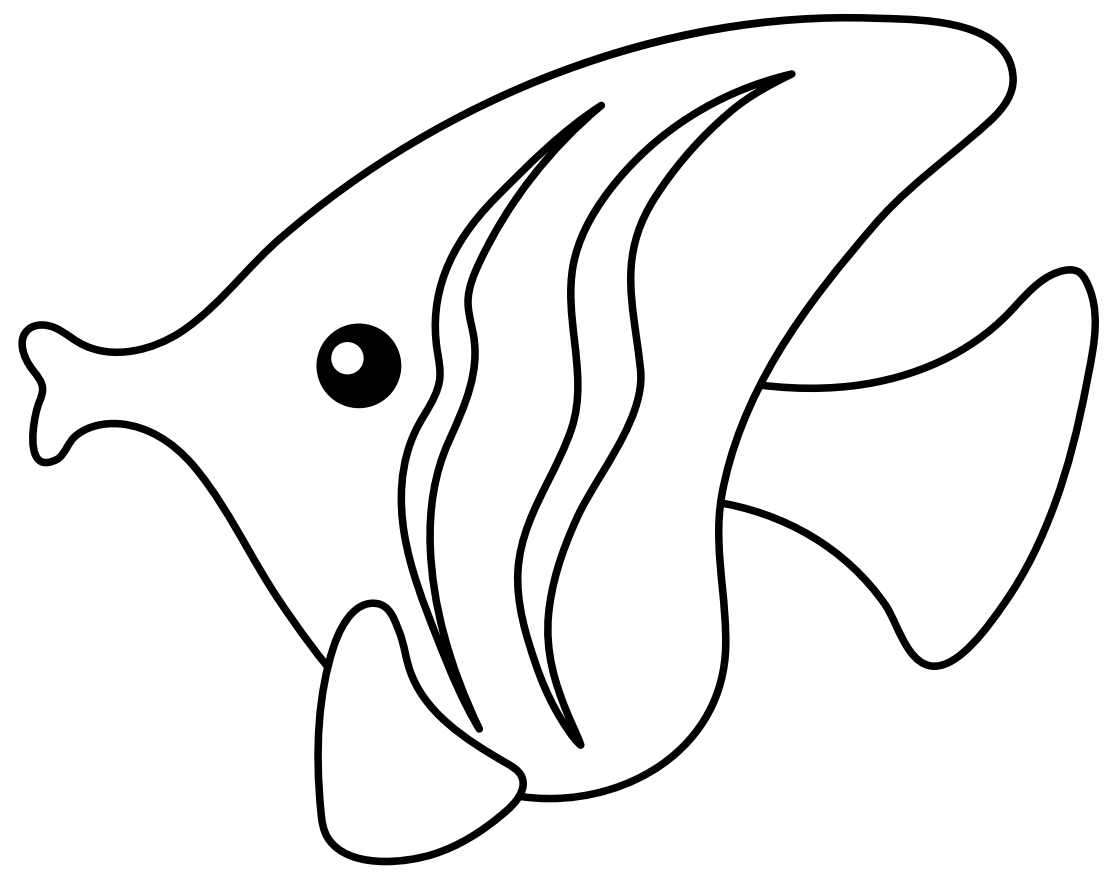

f _ sh

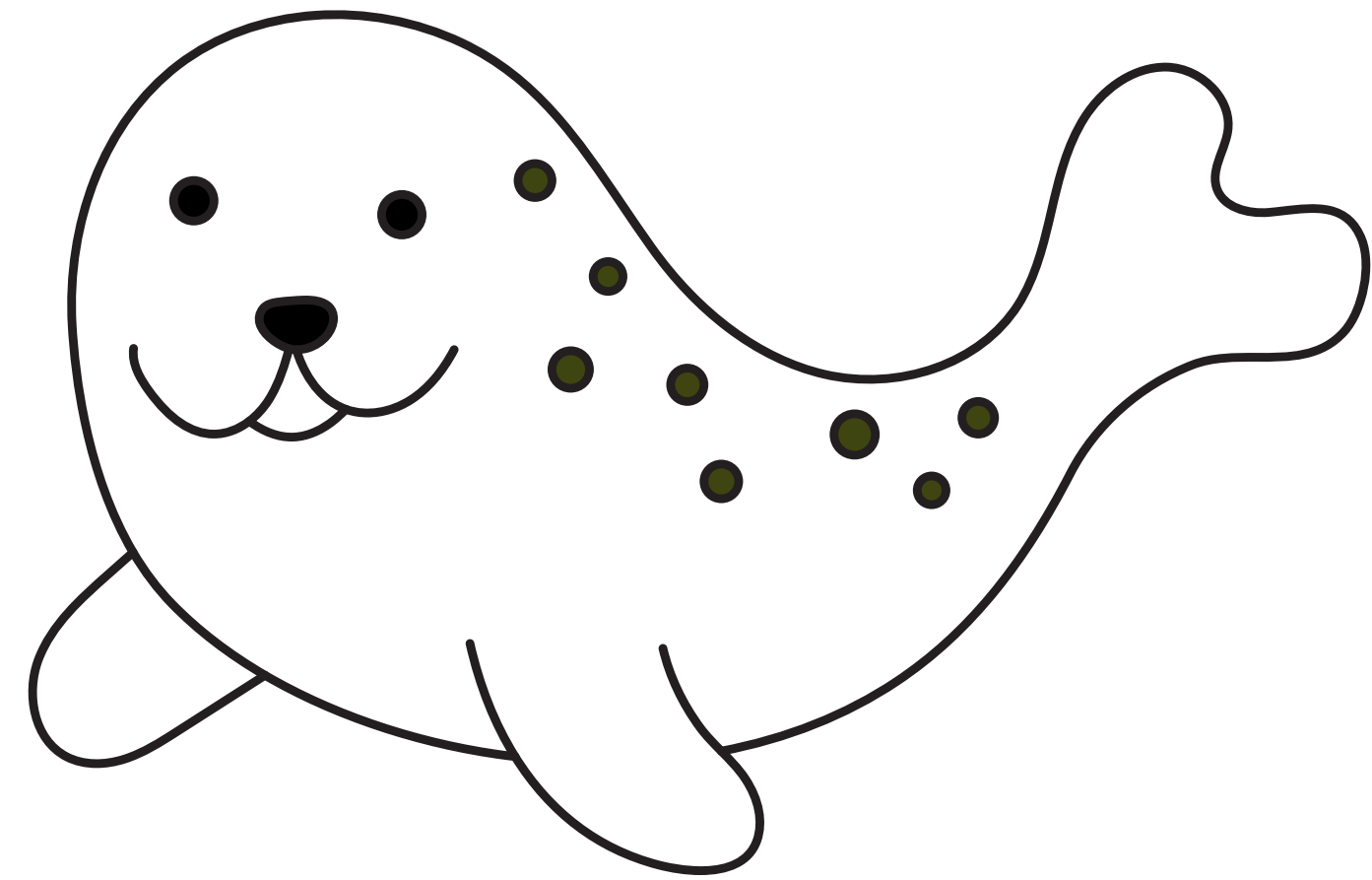

s _ al

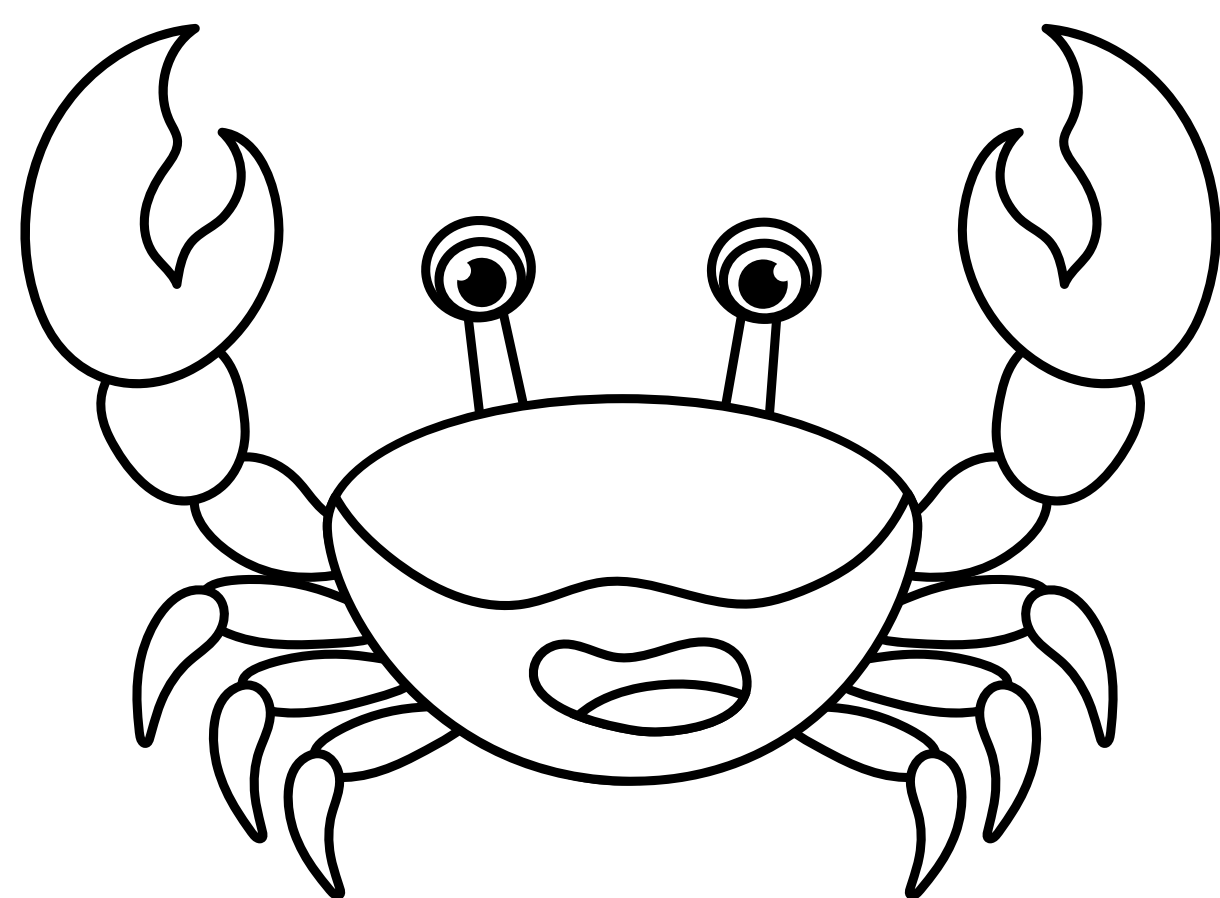

cr _ b

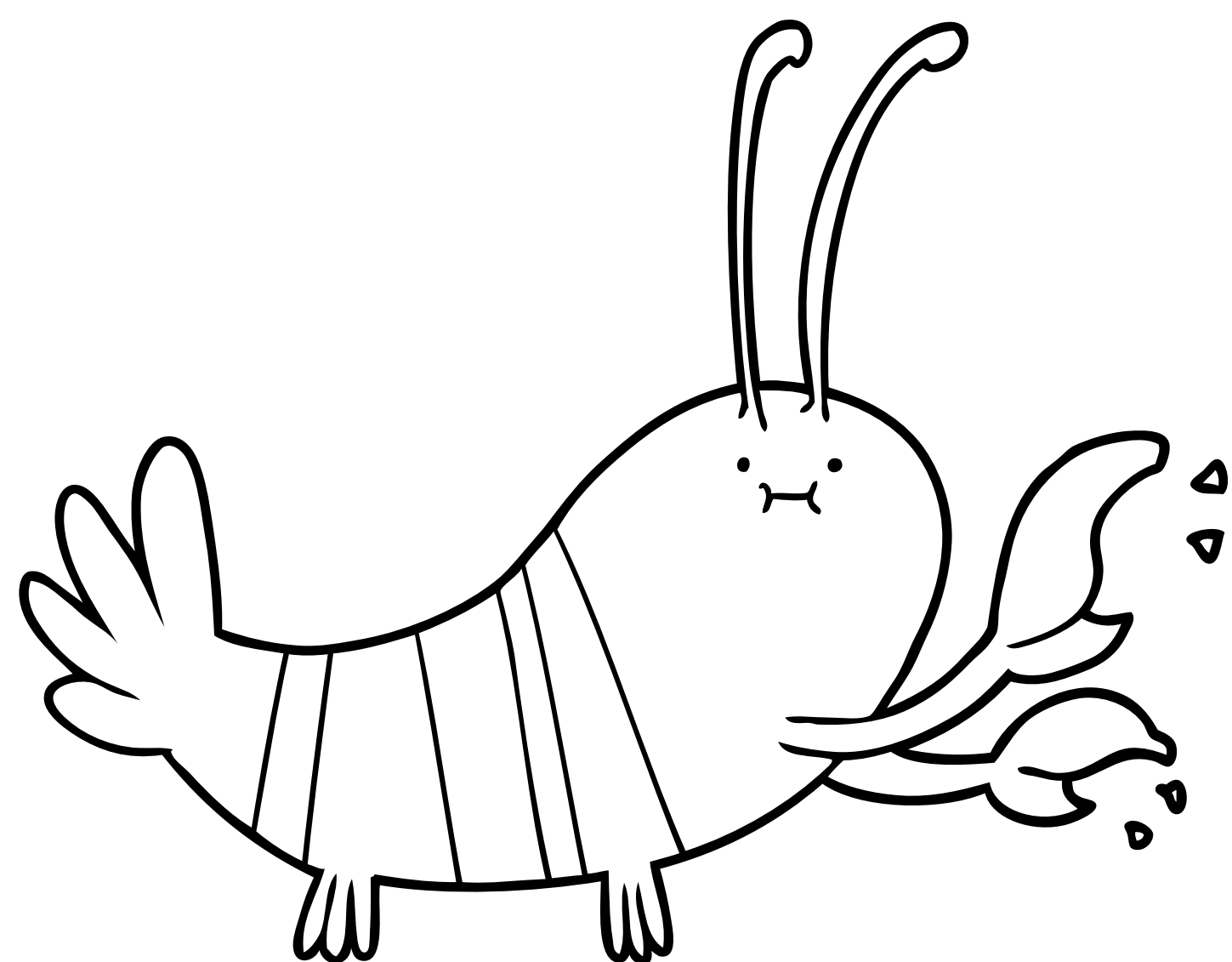

l _ bster

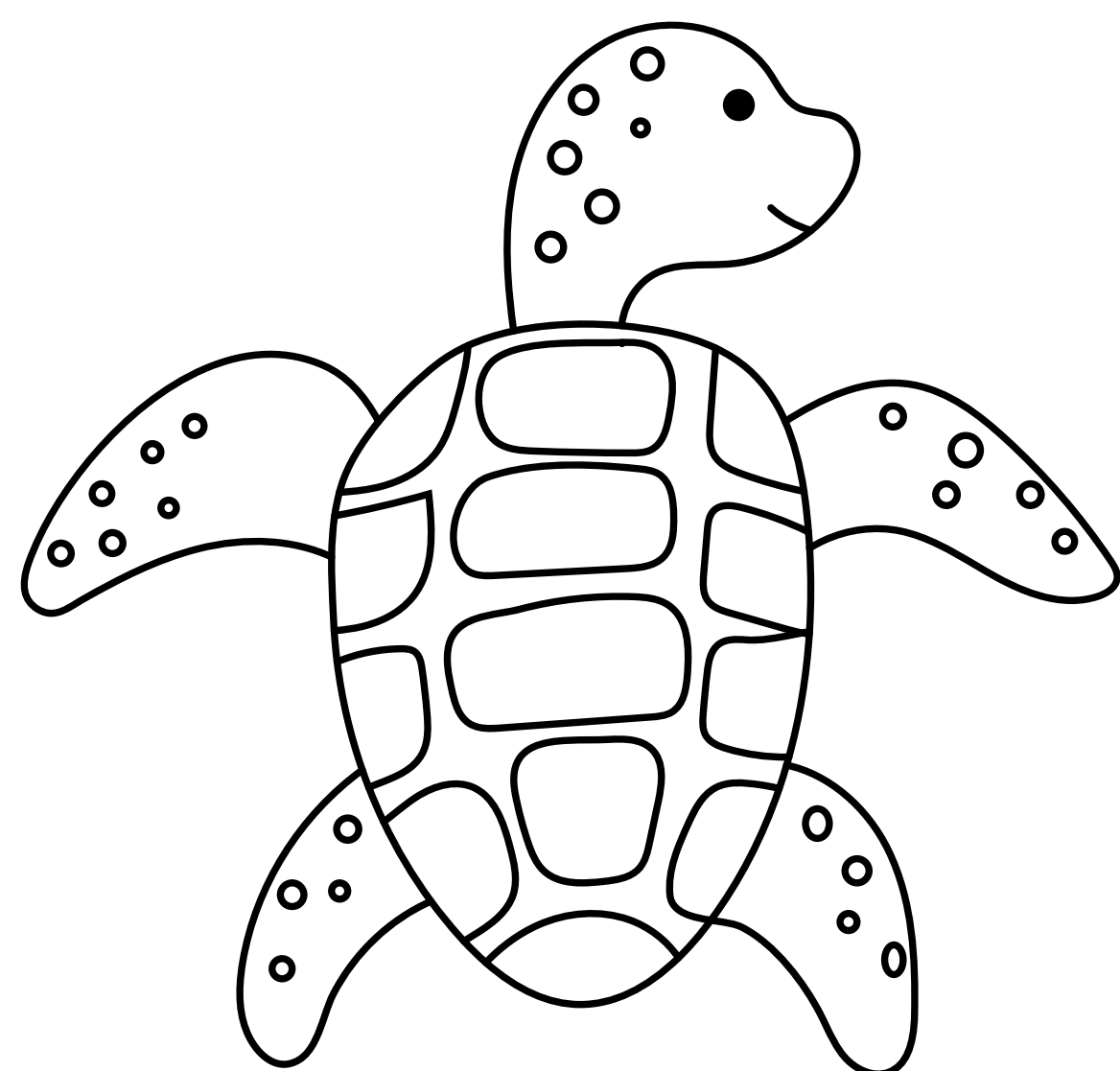

t _ rtle

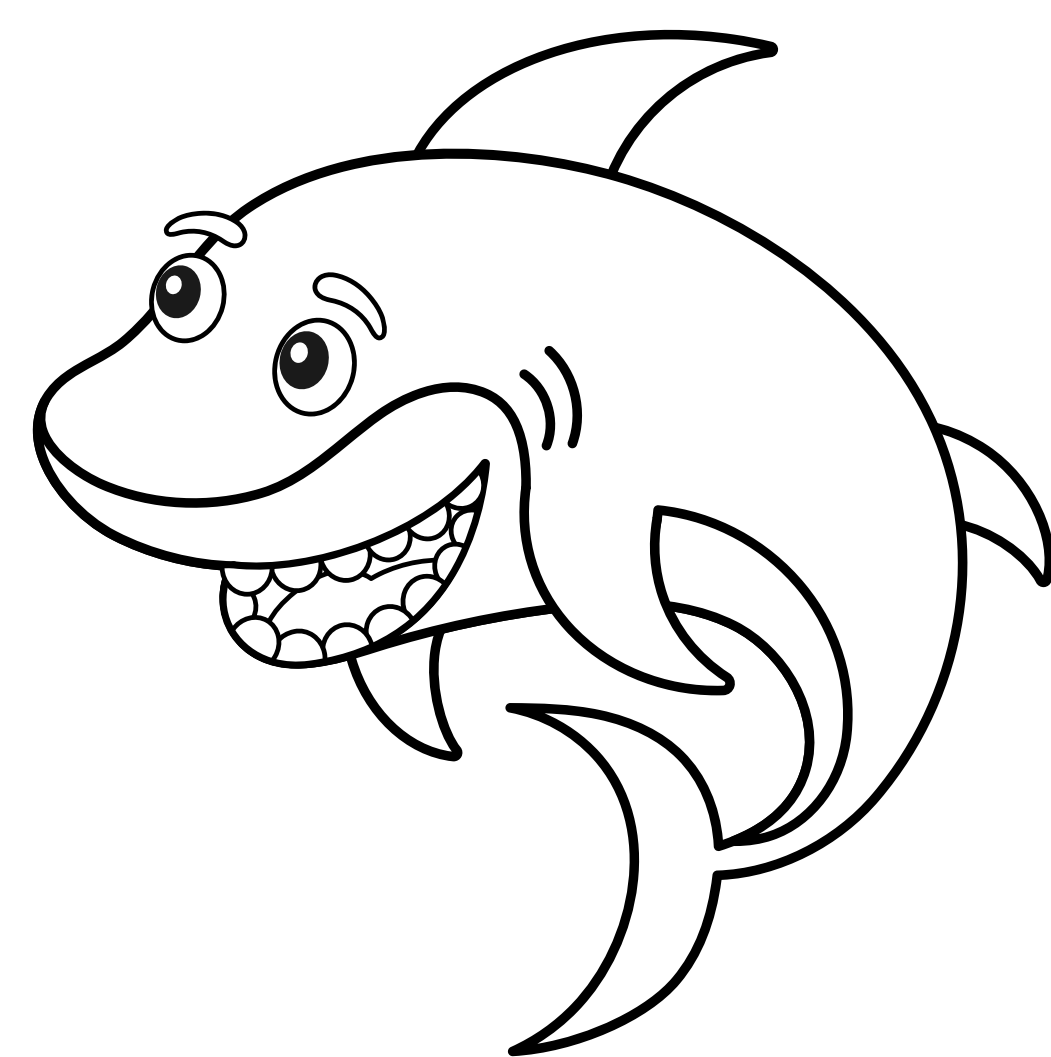

sh _ rk

SPELLING BOXES

Use the boxes to spell each word:

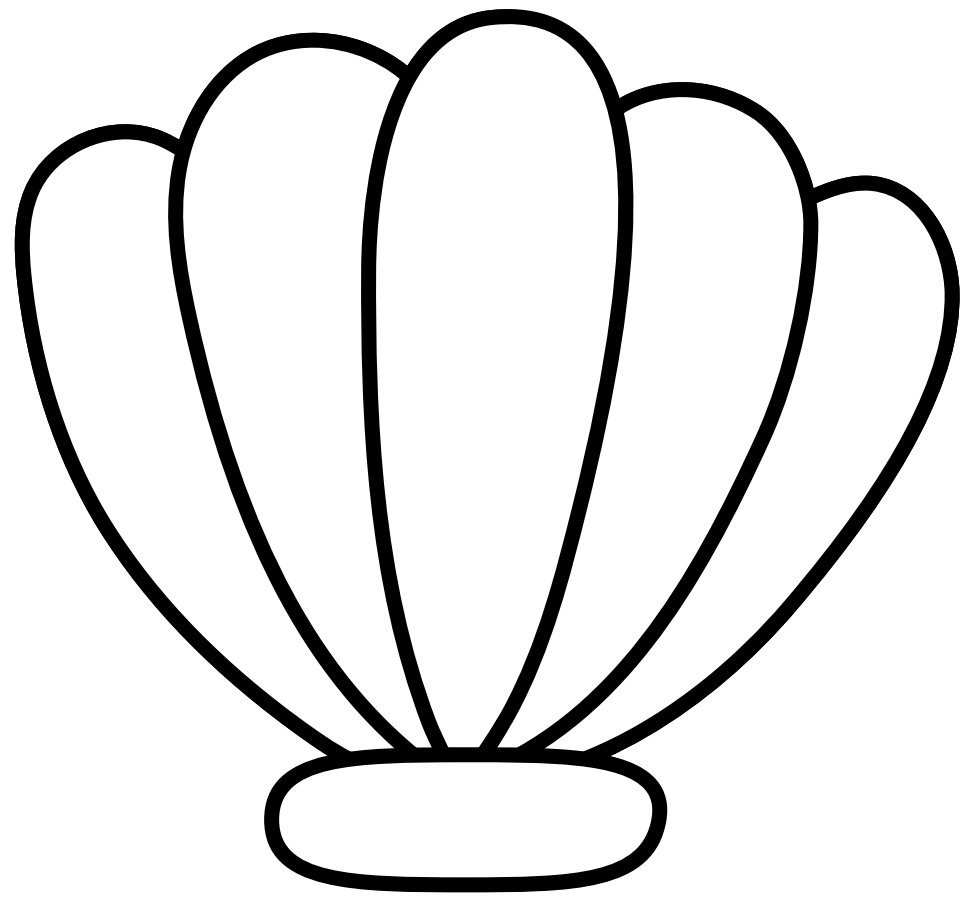

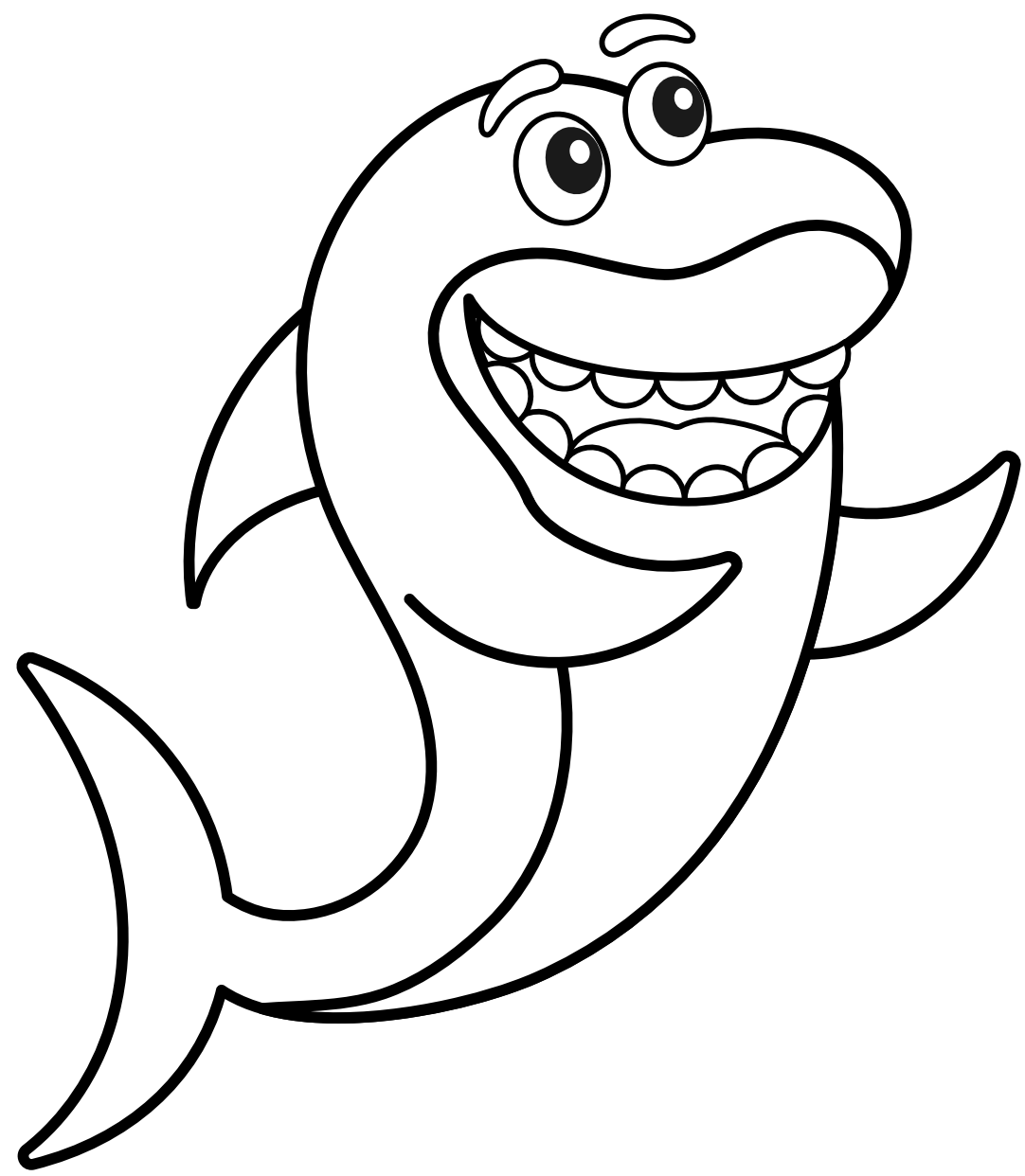

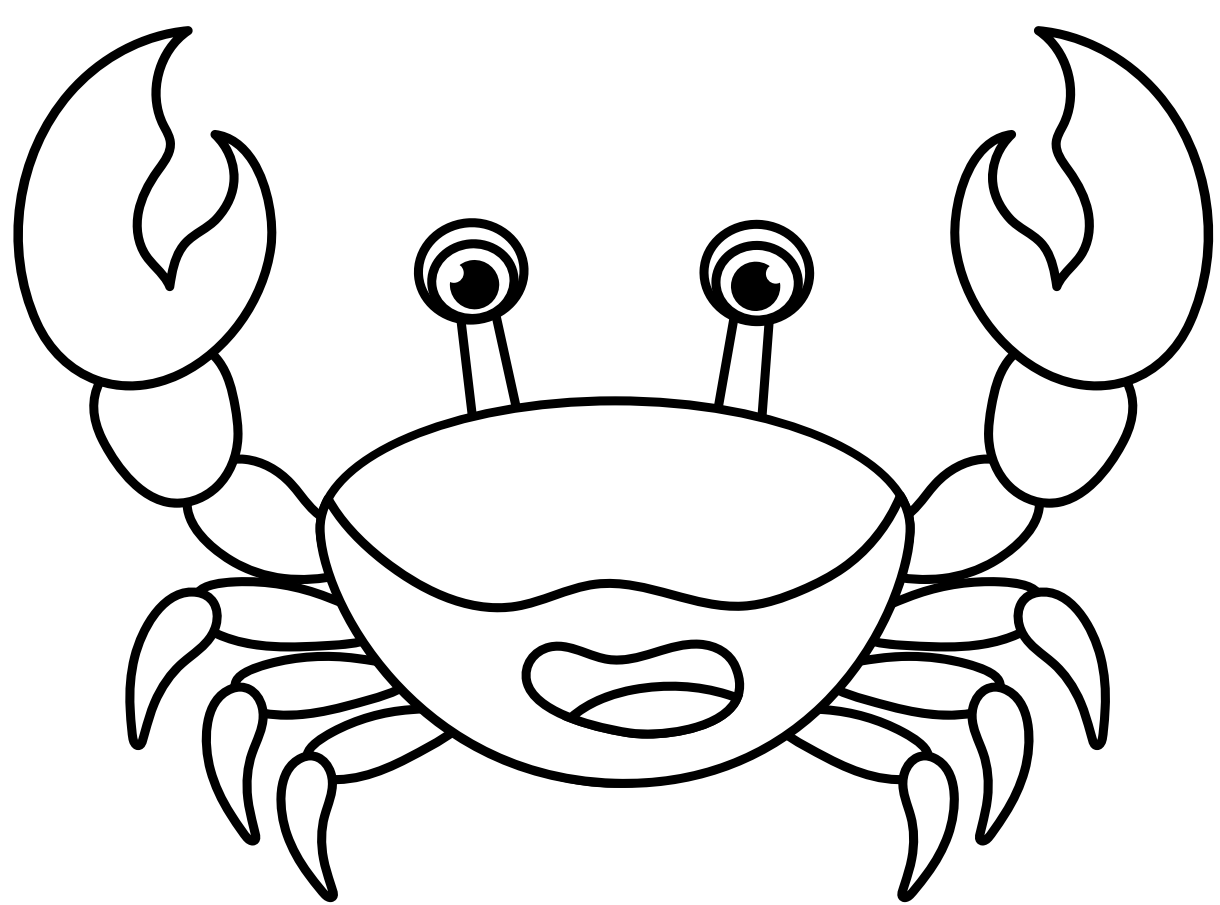

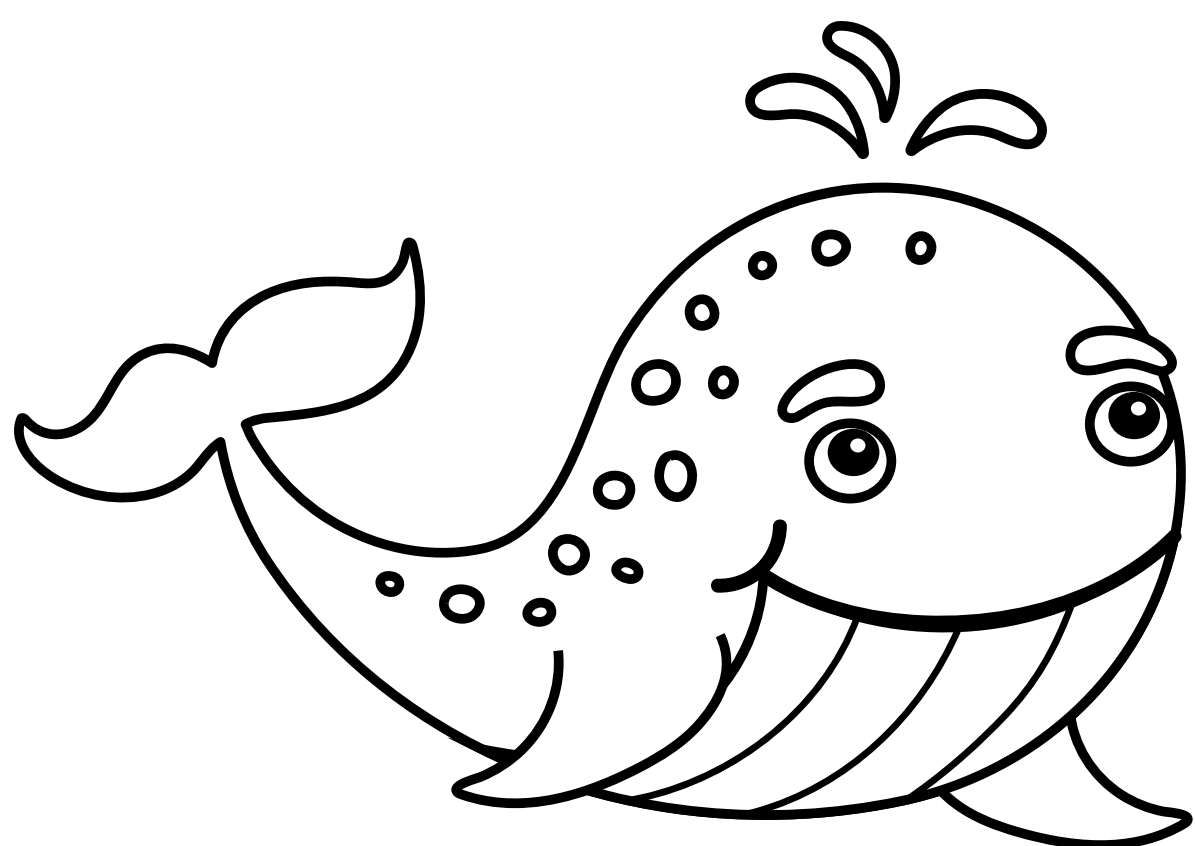

NEED FOR SPEED

Colour the mode of transport which is the faster in the pair:

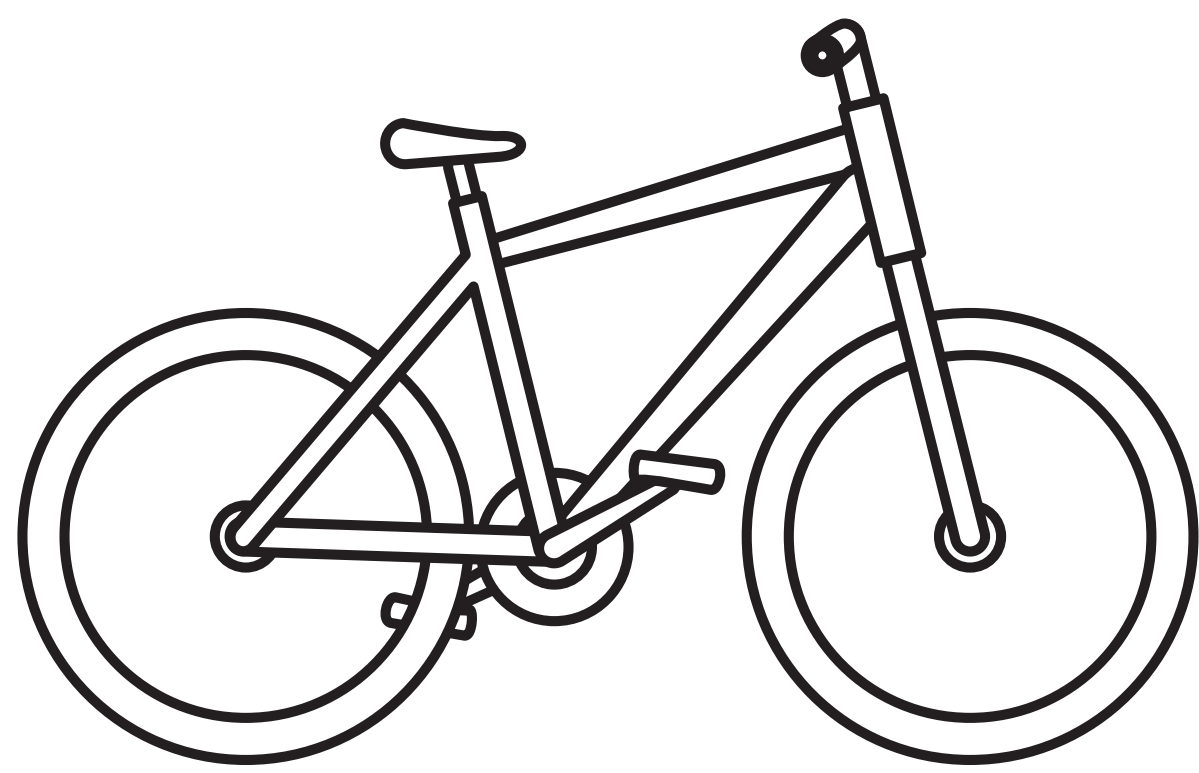

bike

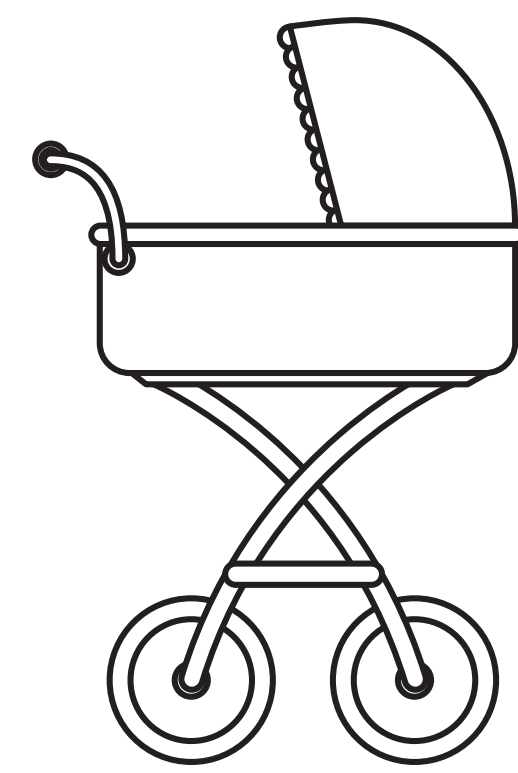

pram

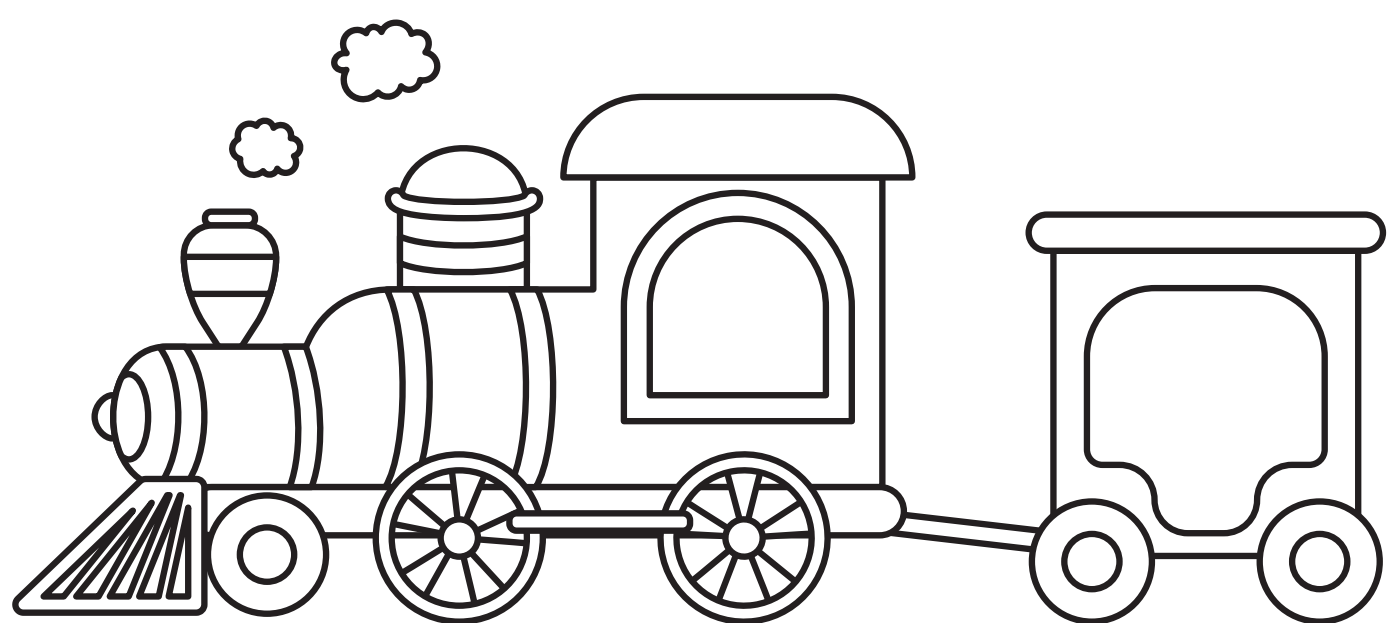

train

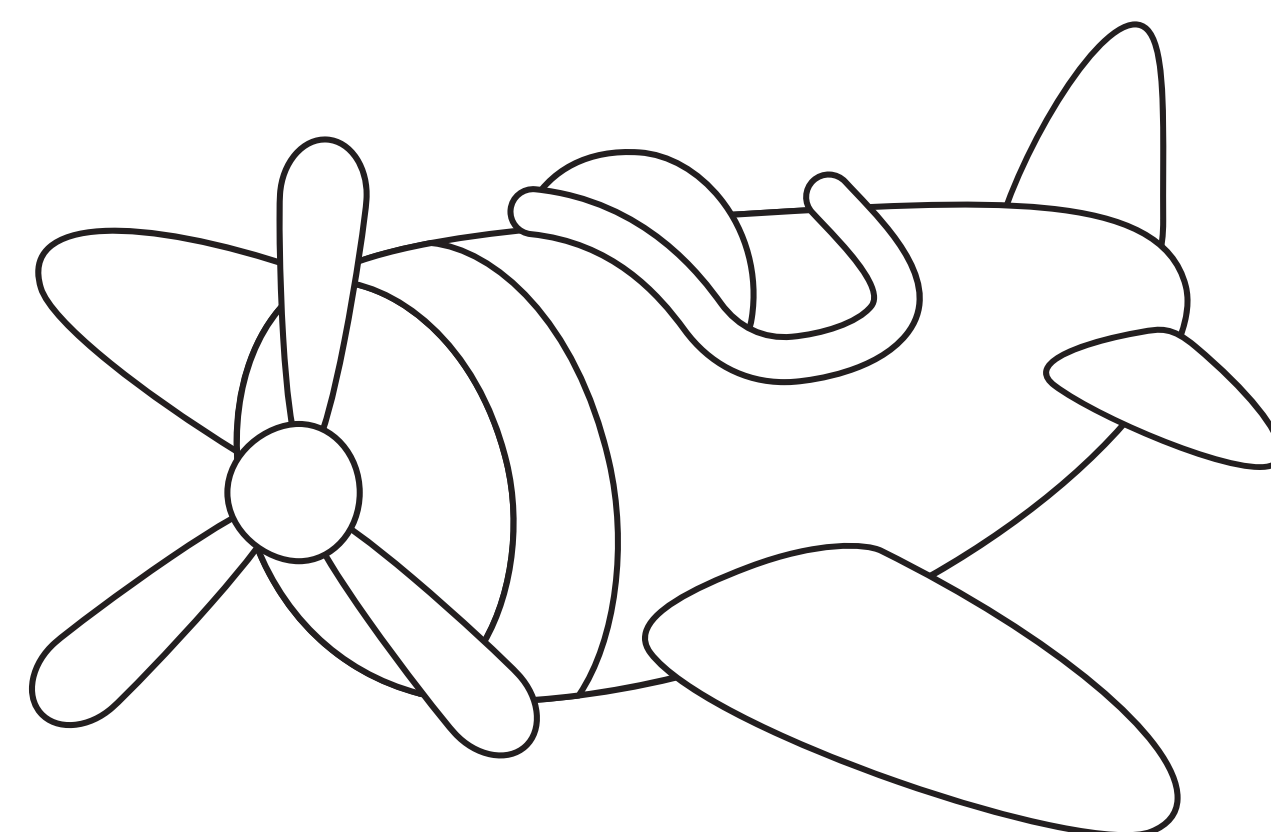

aeroplane

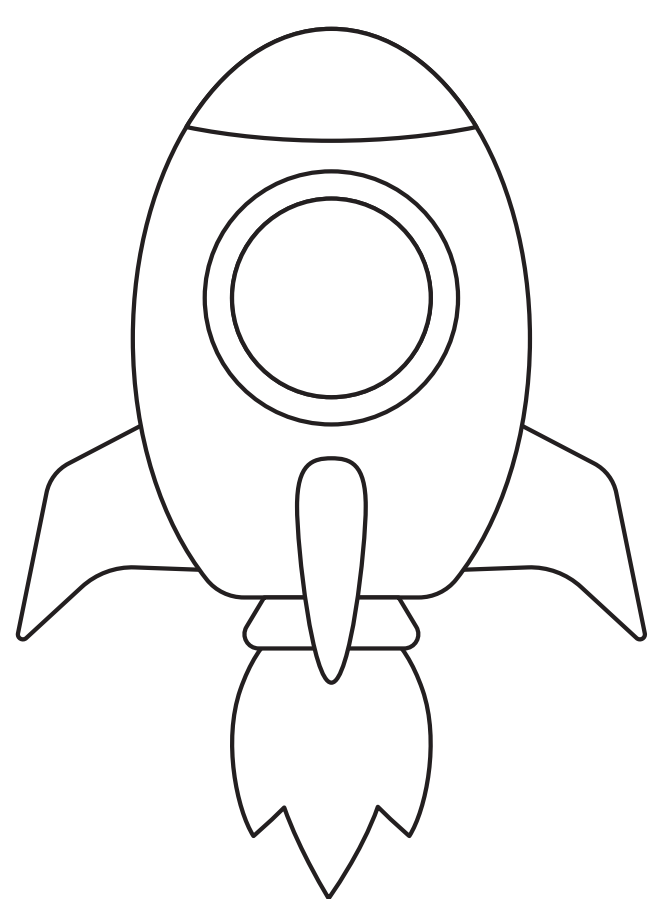

rocket

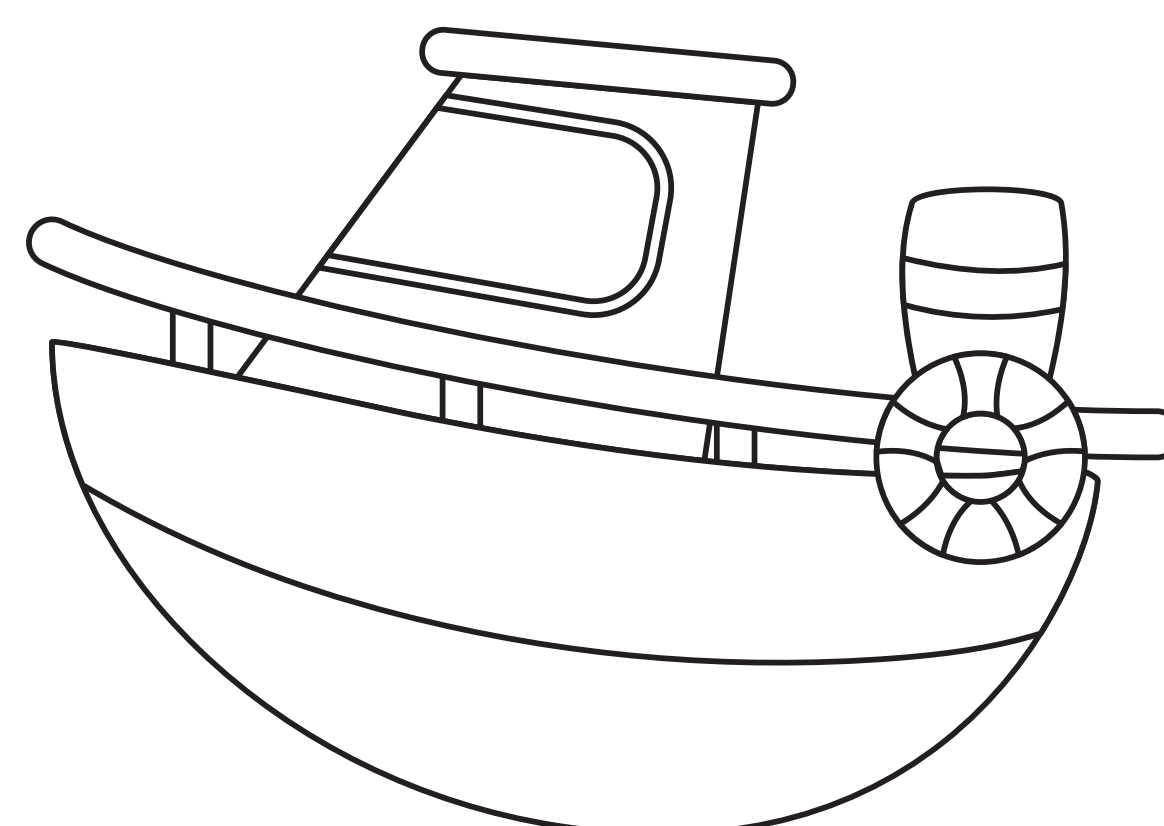

boat



WORD SEARCH

D	O	L	P	H	I	N	B
P	S	U	P	O	T	C	O
F	T	S	W	I	M	L	D
I	A	A	E	A	A	A	E
S	R	N	A	A	M	M	E
H	F	D	E	R	L	O	W
A	I	Y	S	C	Y	O	A
R	S	H	A	R	K	C	E
S	H	E	L	L	N	S	S

fish

dolphin

clam

swim

starfish

shark

octopus

seal

shell

sand

seaweed

sea

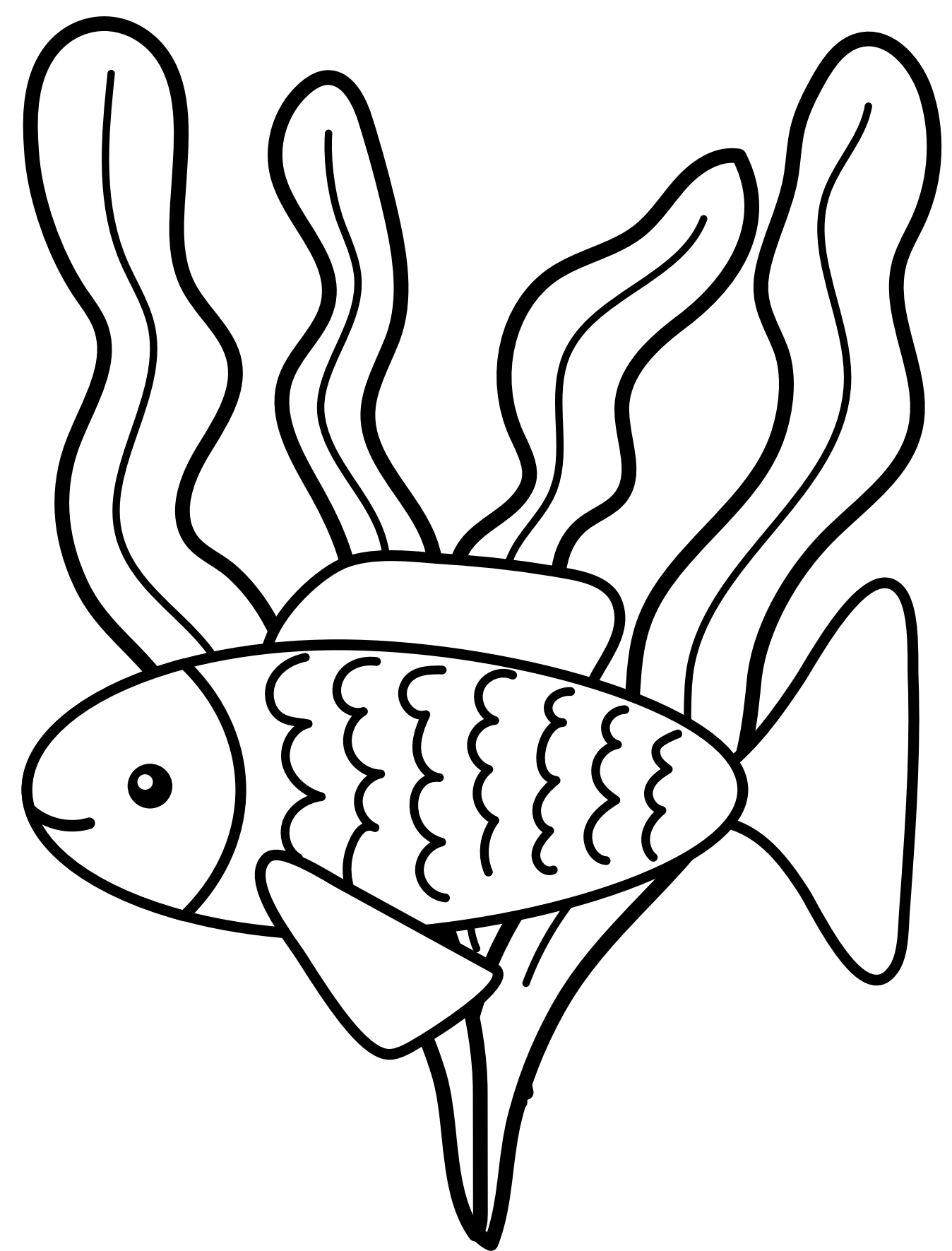



COLOUR BY NUMBER

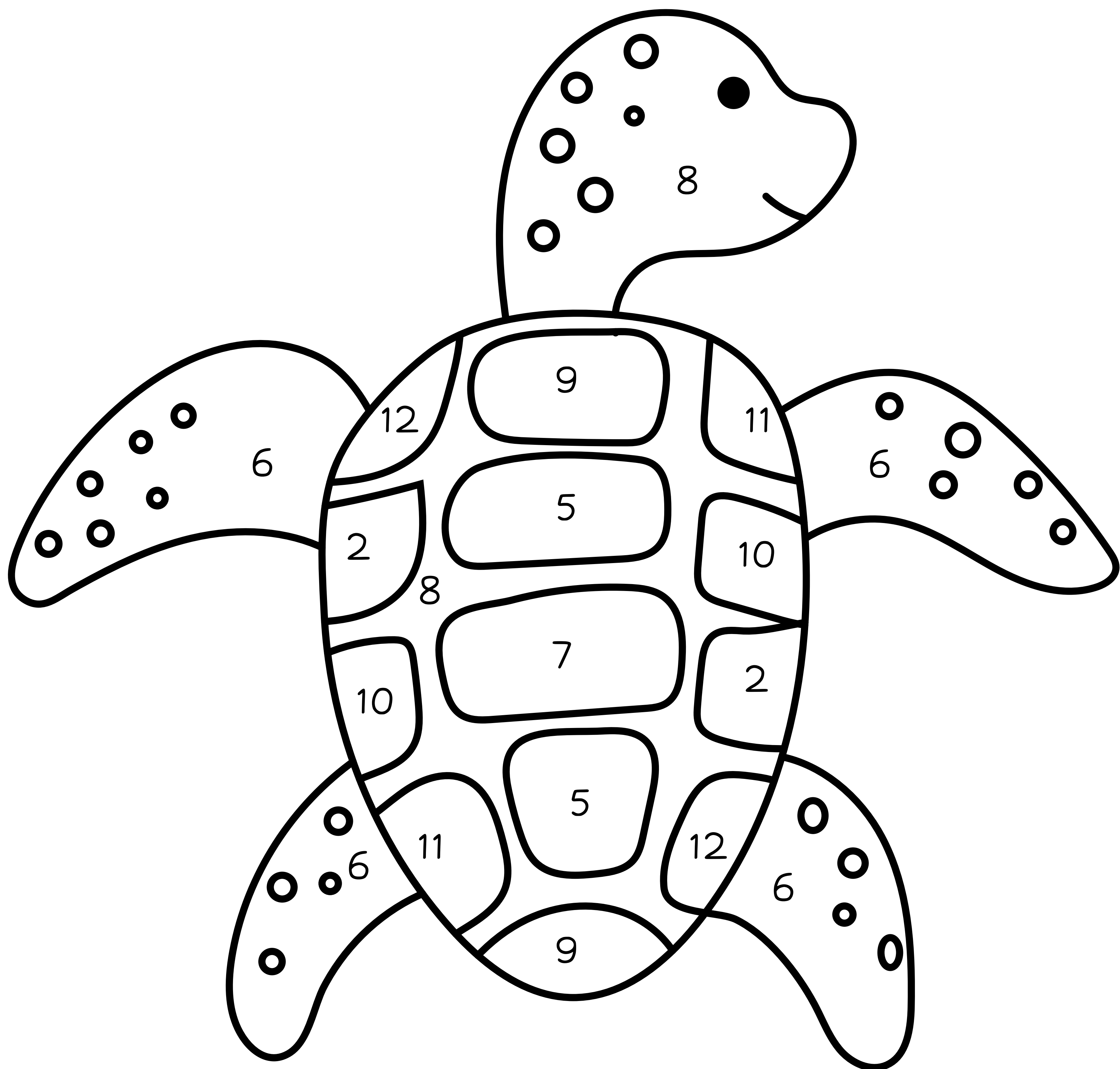

$5 + 3 =$ light green

$4 + 2 =$ dark green

$4 + 5 =$ yellow

$3 + 2 =$ orange

$3 + 8 =$ purple

$3 + 4 =$ red

$5 + 5 =$ purple

$1 + 1 =$ pink

$6 + 4 =$ light blue

$6 + 6 =$ dark blue



DRAWING

Complete this underwater scene. Include at least four different sea creatures:

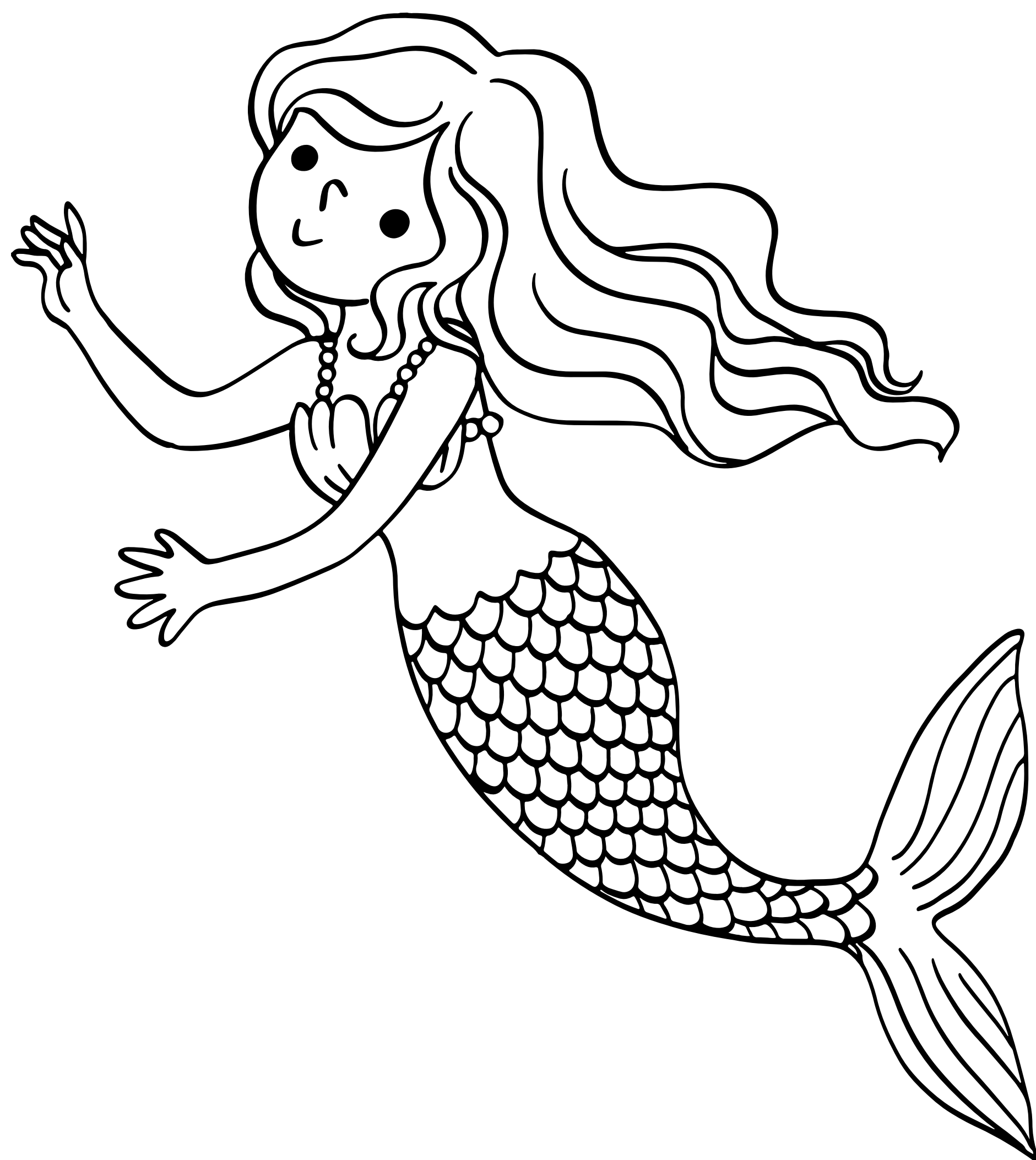



TRANSPORTATION

Activities

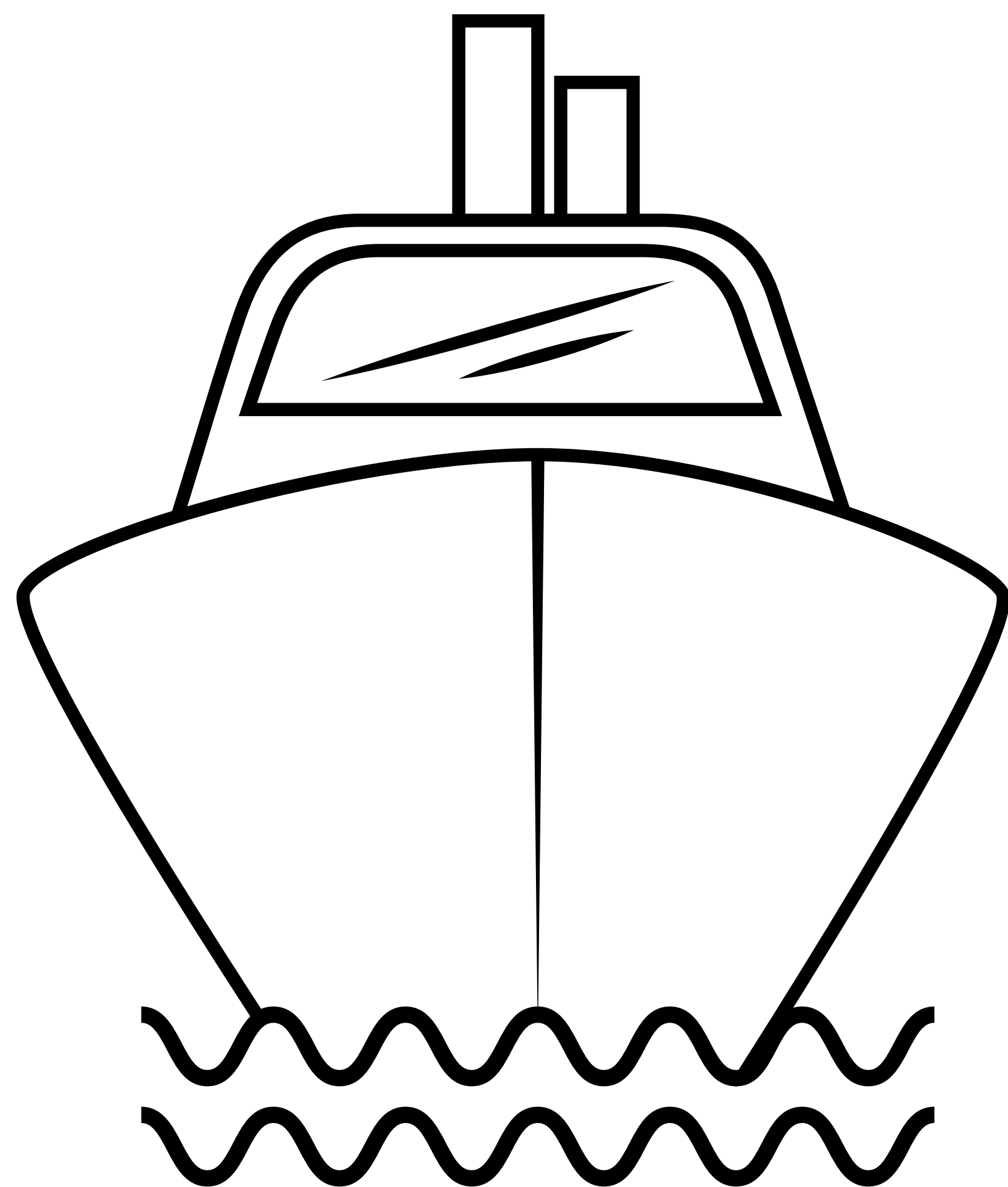
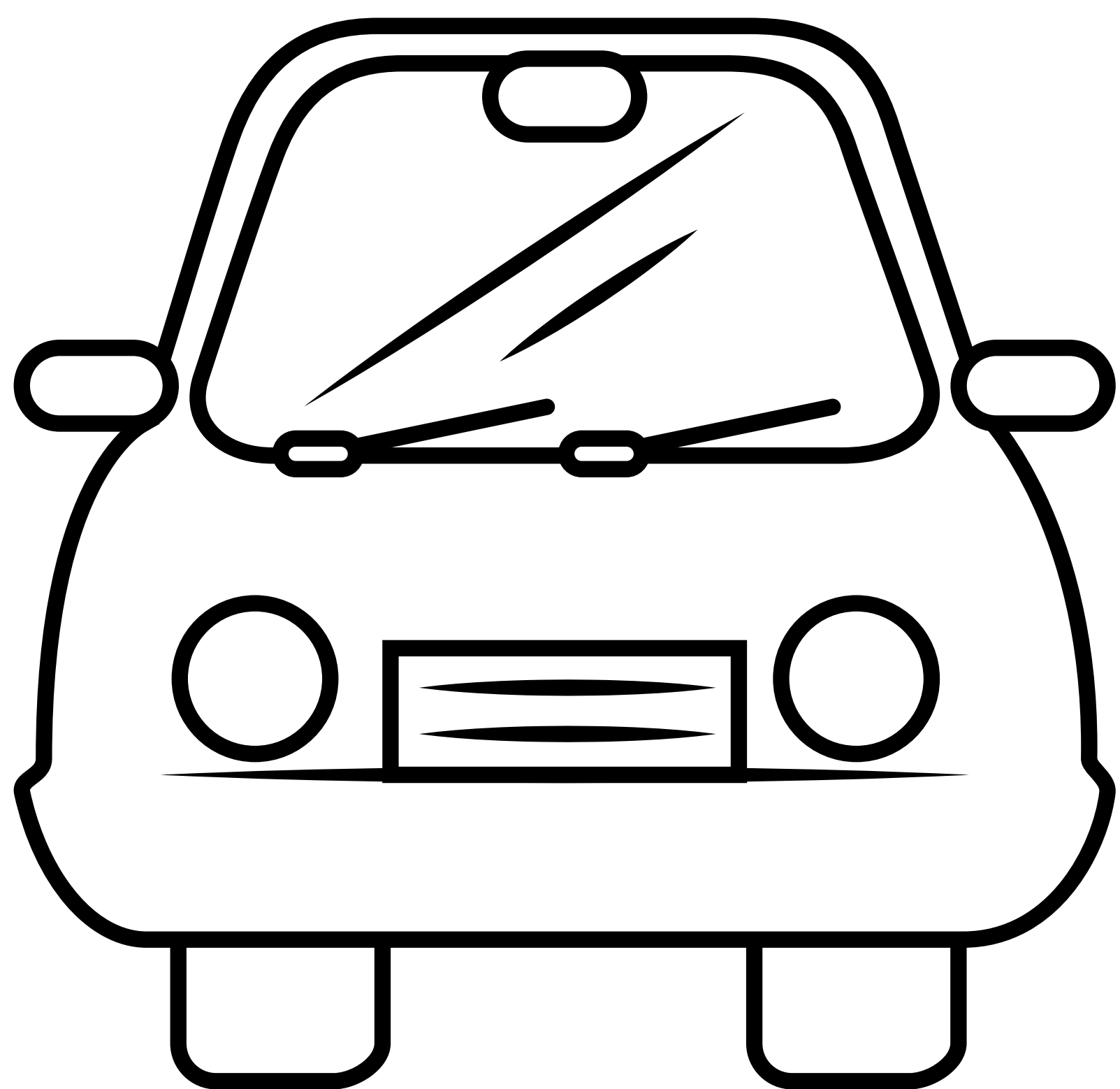
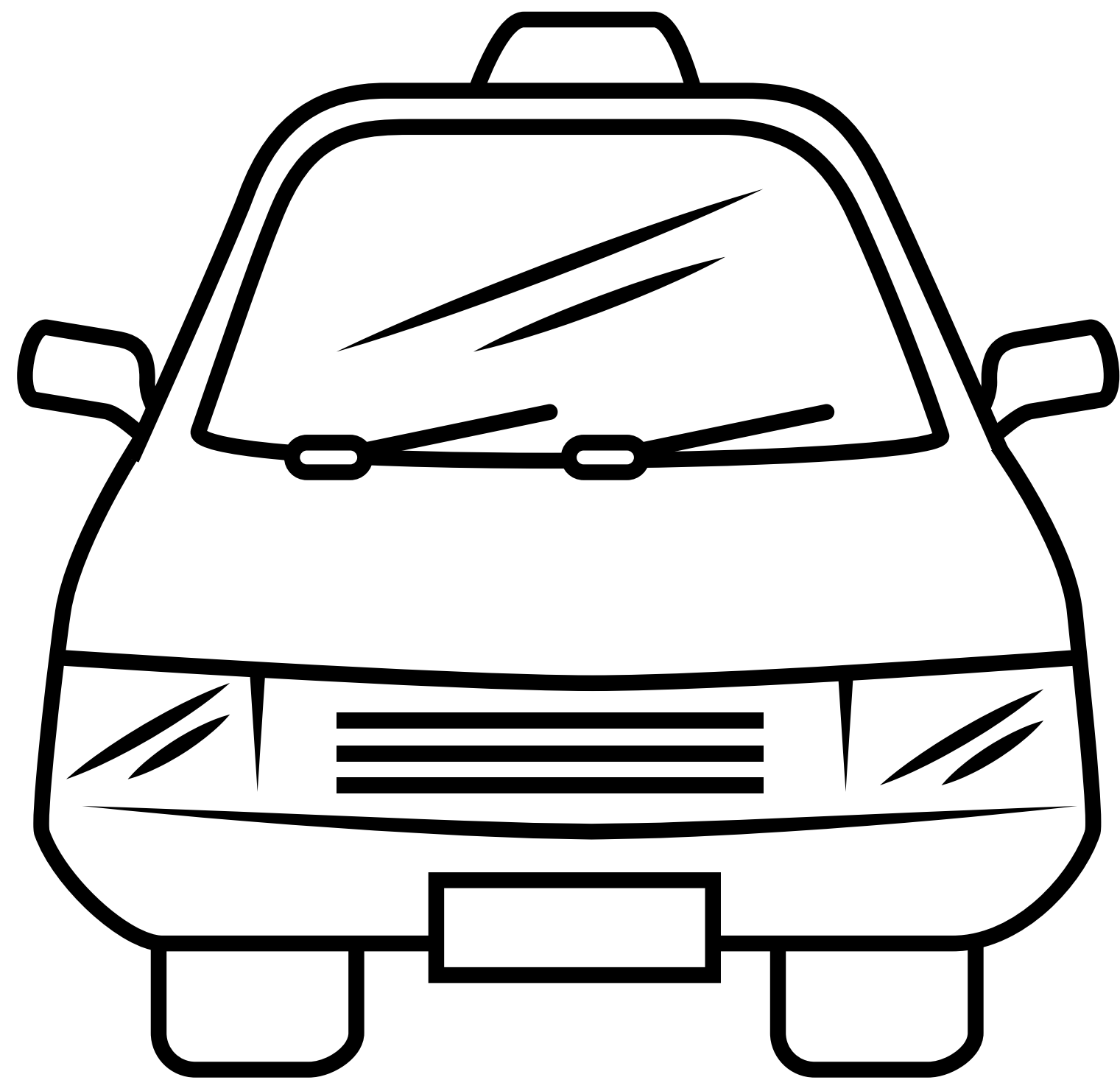
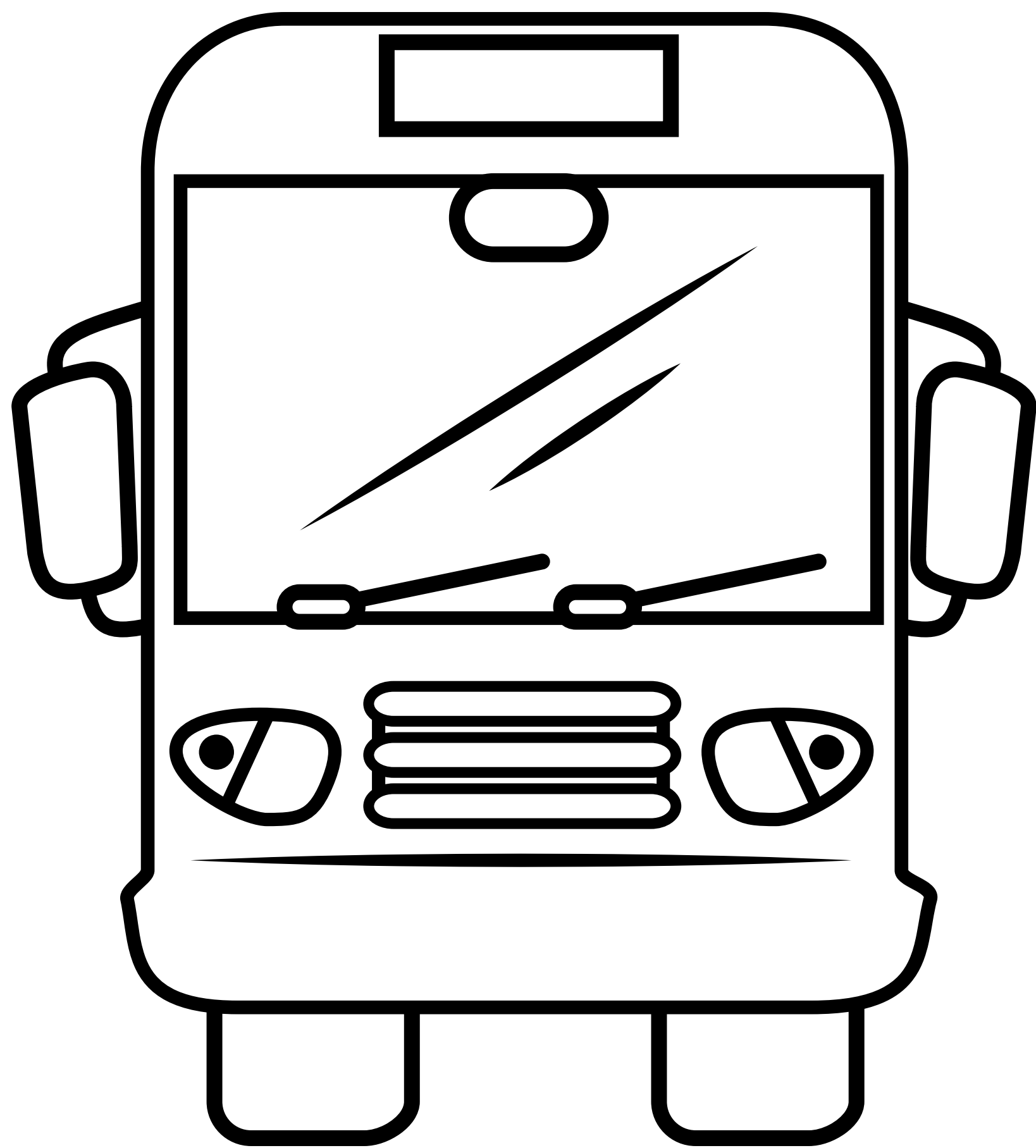

TRACING

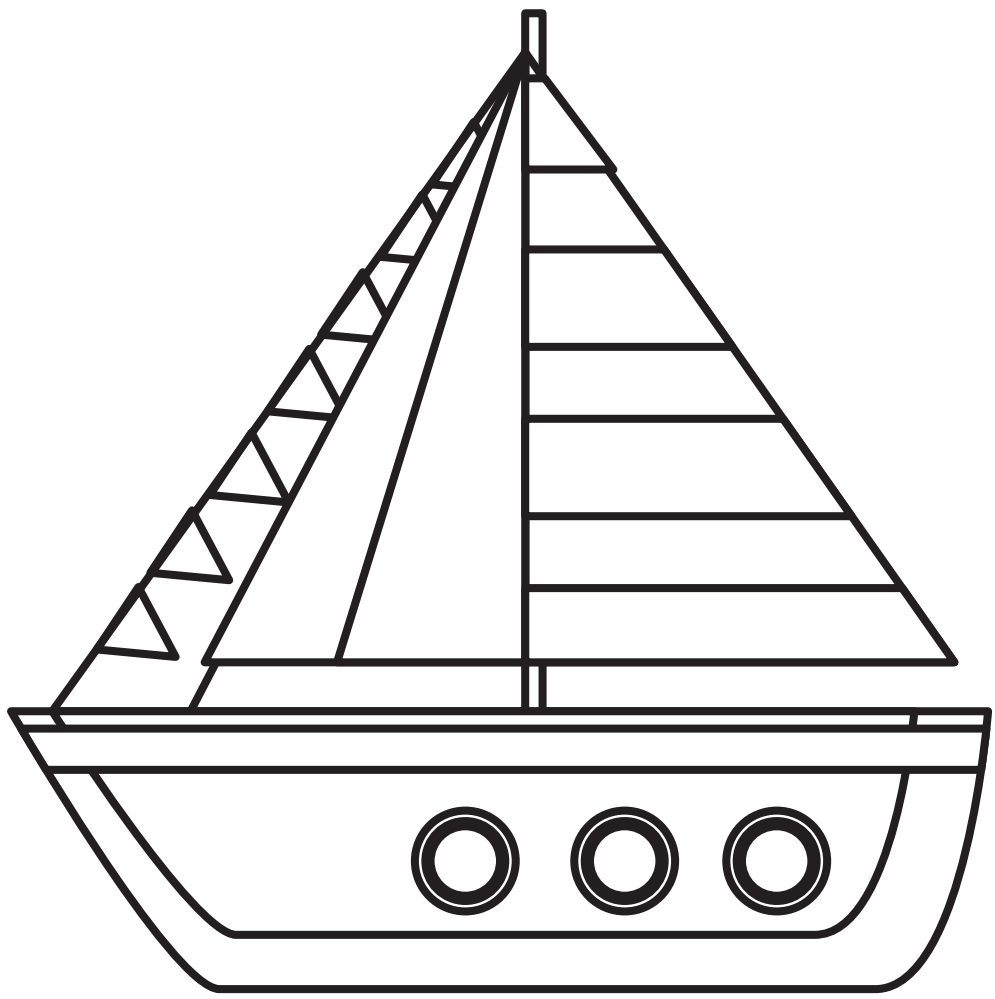

boat

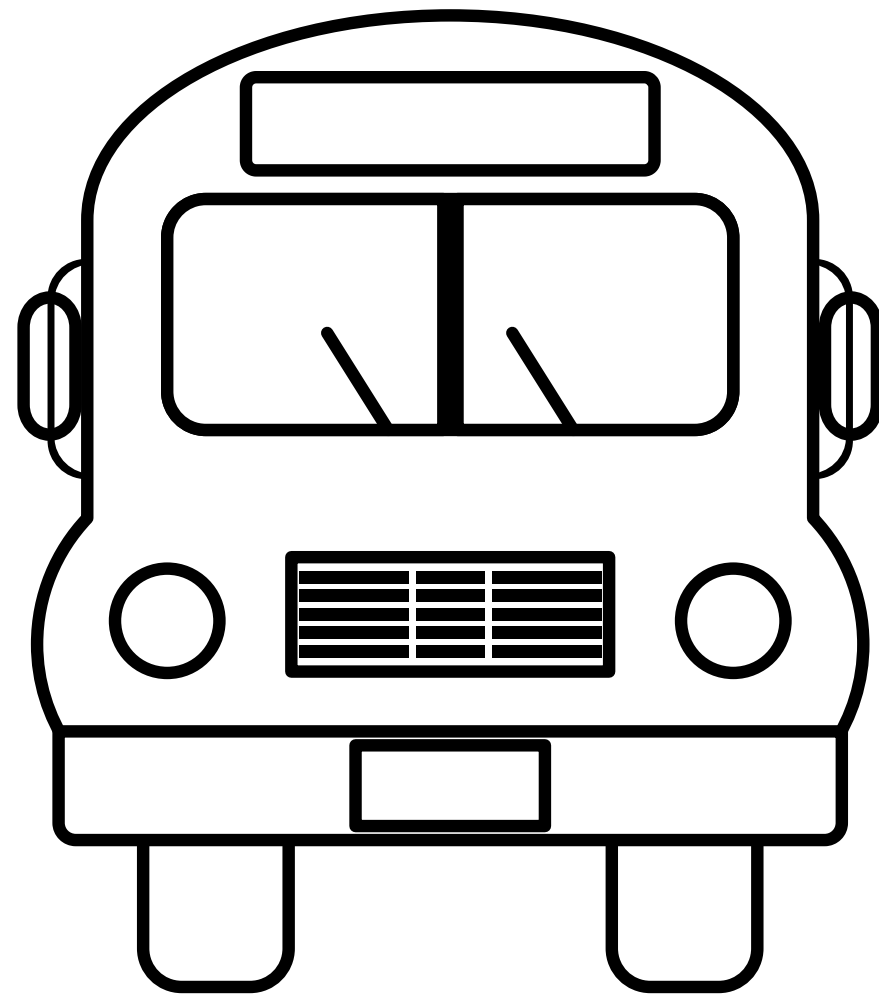

bus

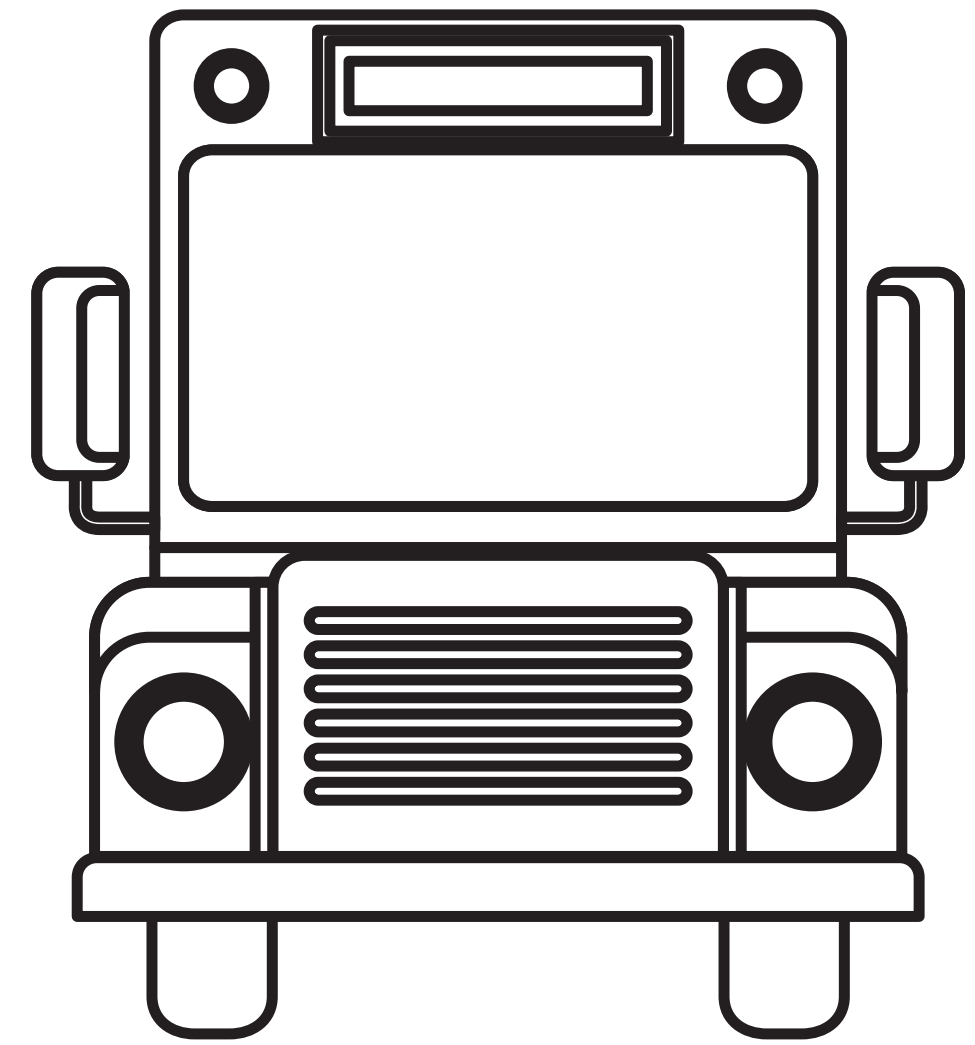

truck

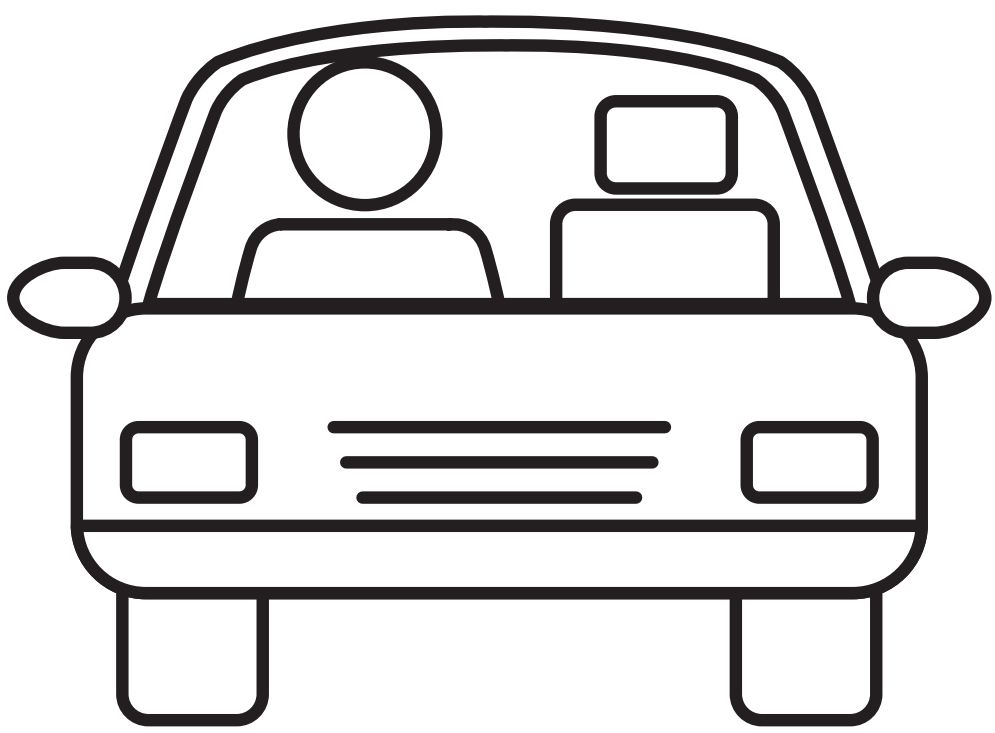

car



buggy

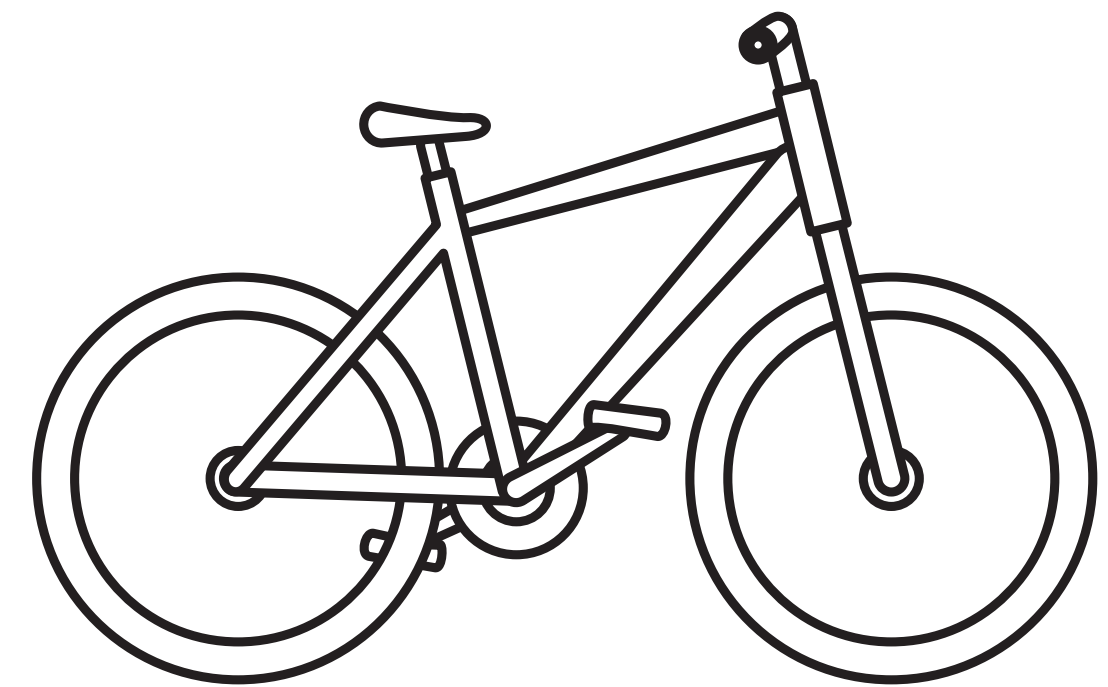

bike

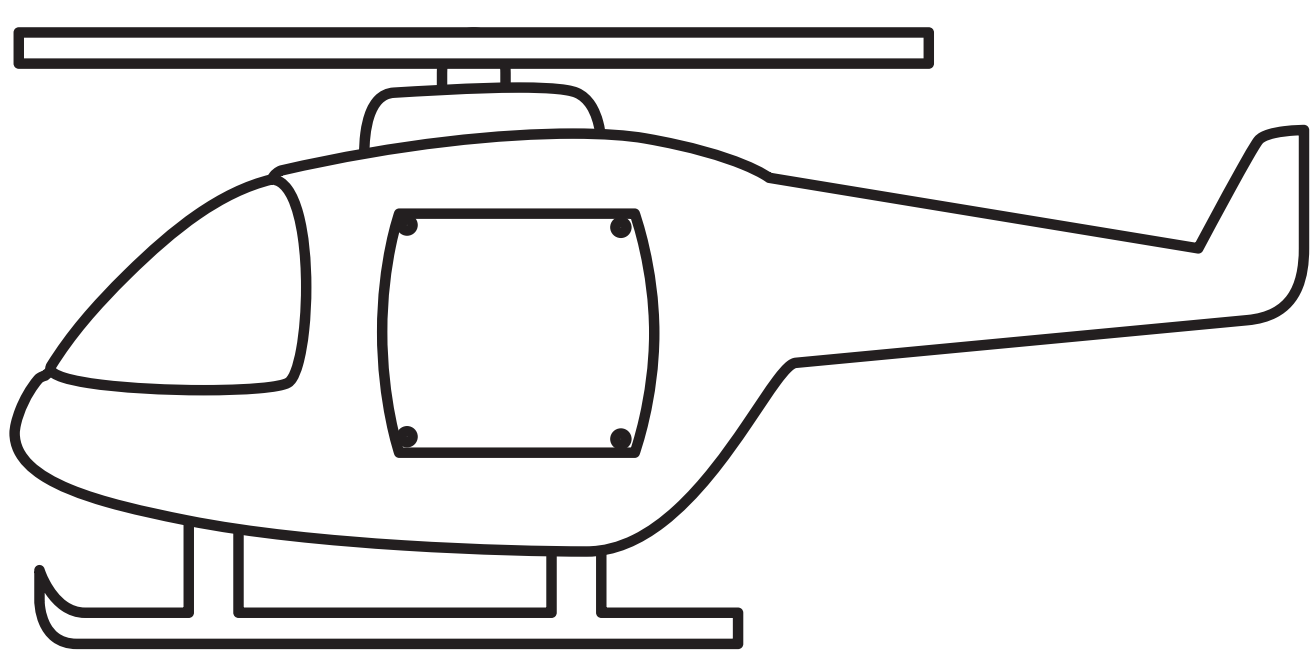

helicopter

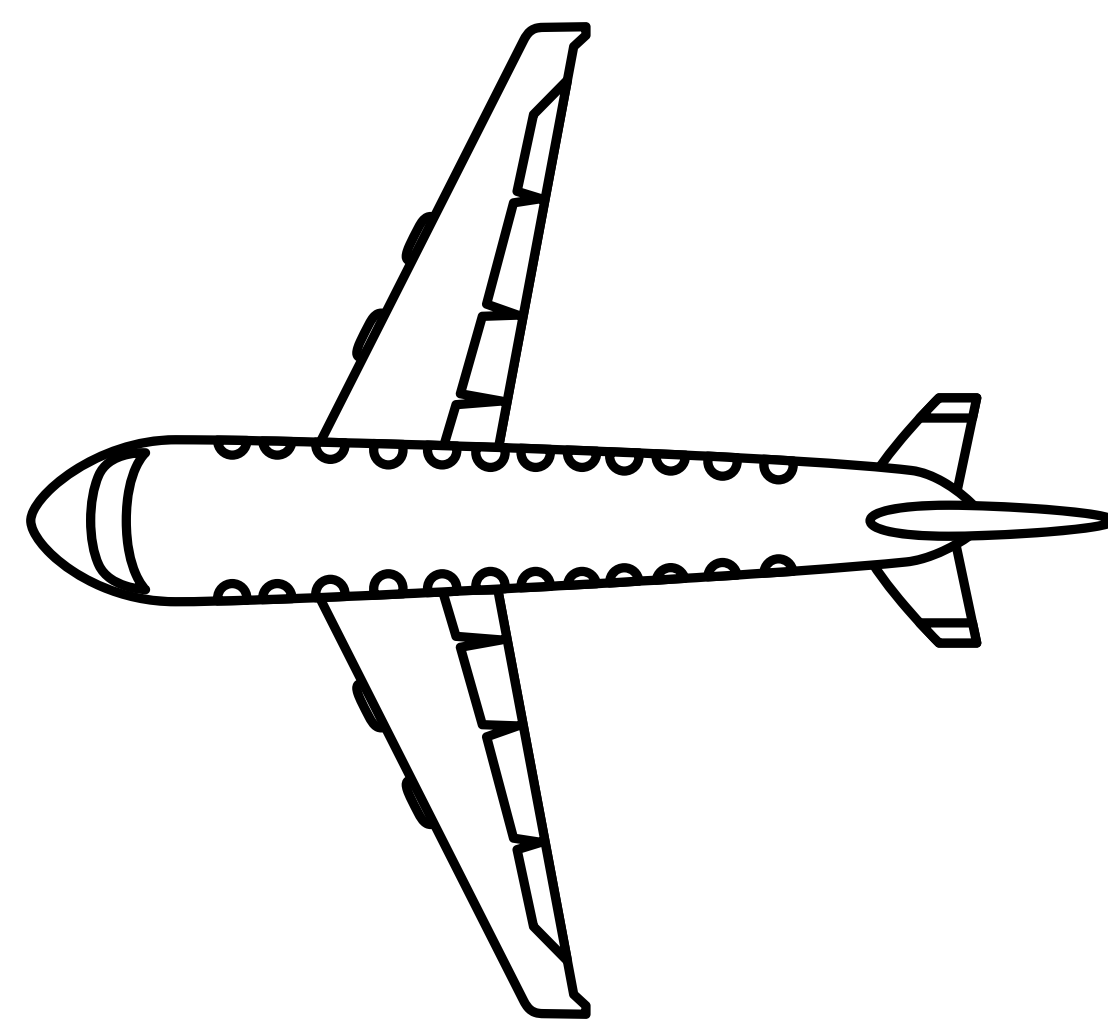

airplane



DRAWING

Draw a picture to match each word:

--	--	--

train

tram

taxi

--	--	--

ship

scooter

van

LAND, AIR, WATER

Colour the objects the following code:

- Land transport: green
- Air transport: blue
- Water transport: yellow

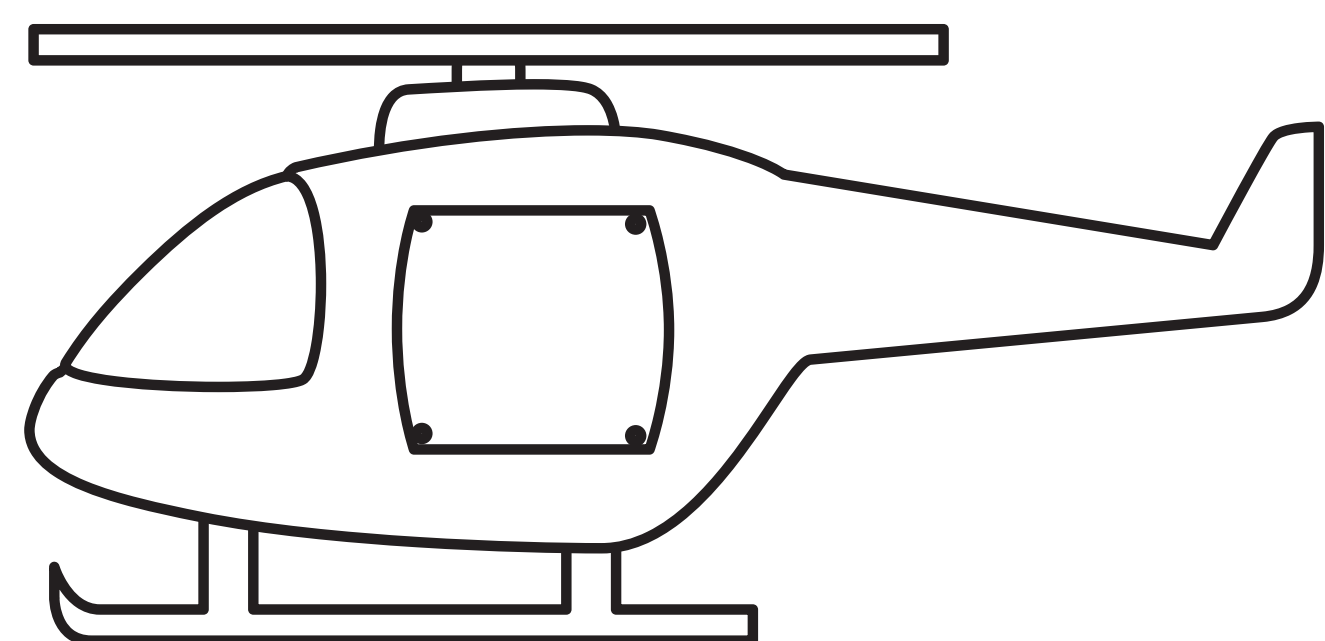
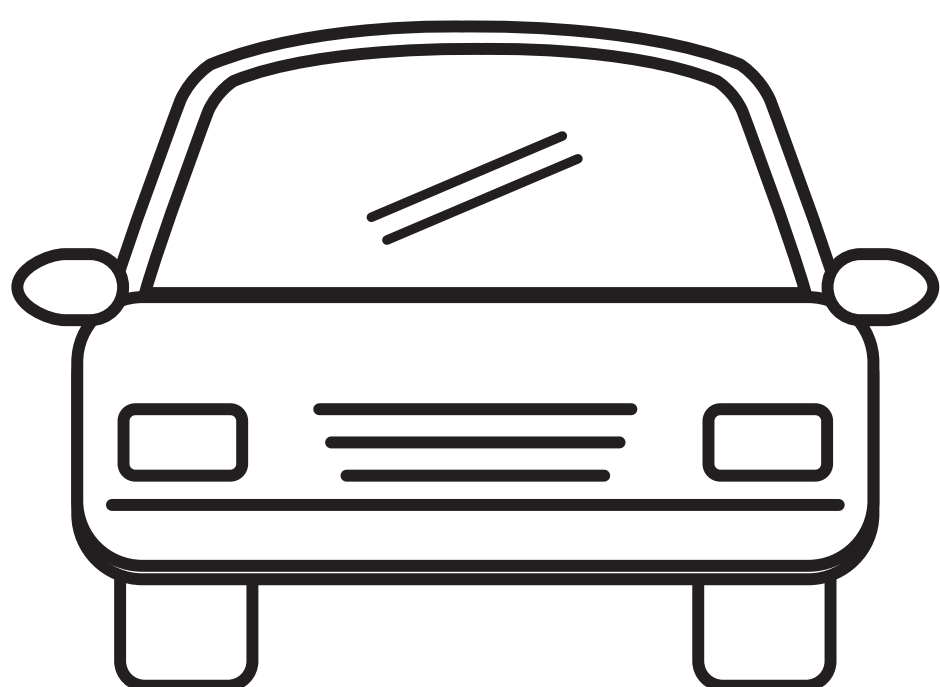
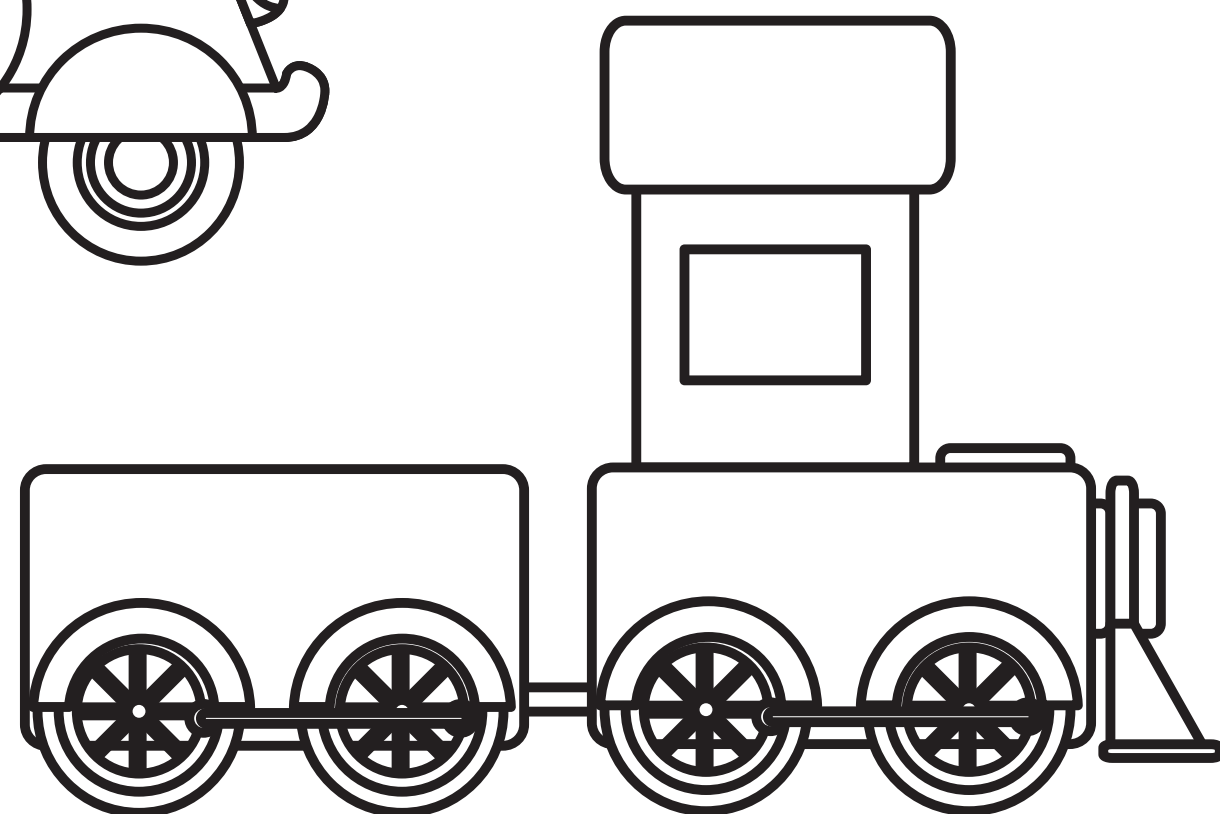
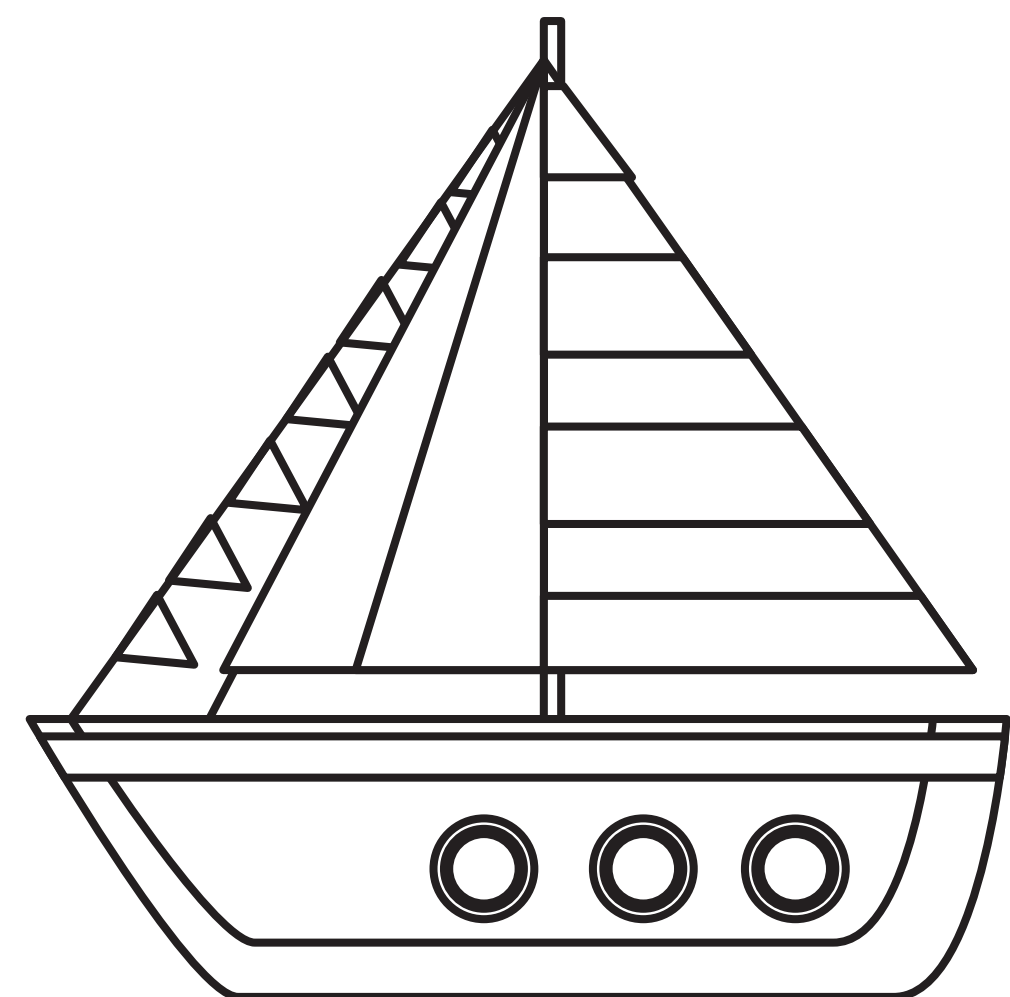
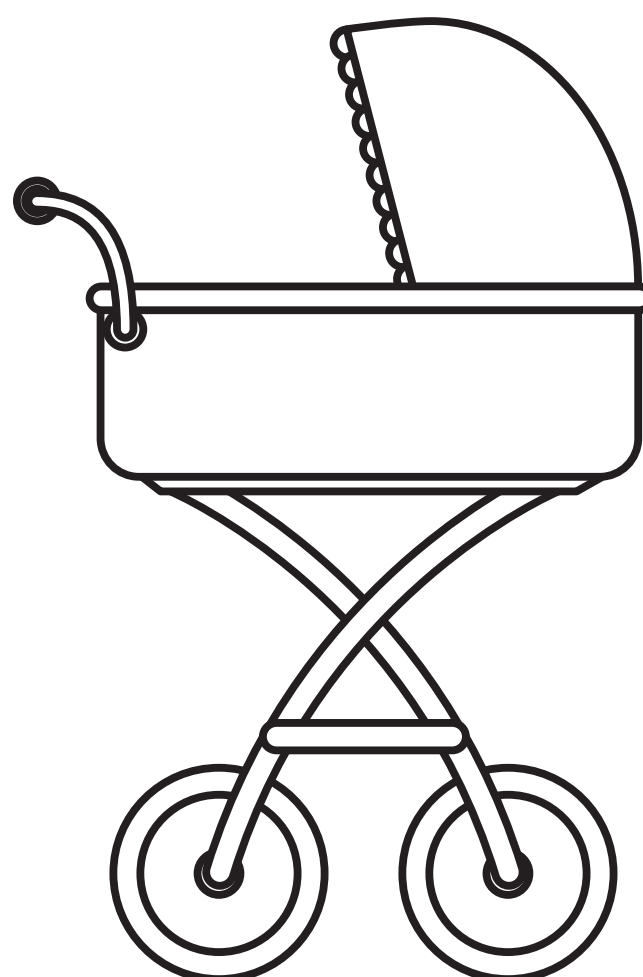
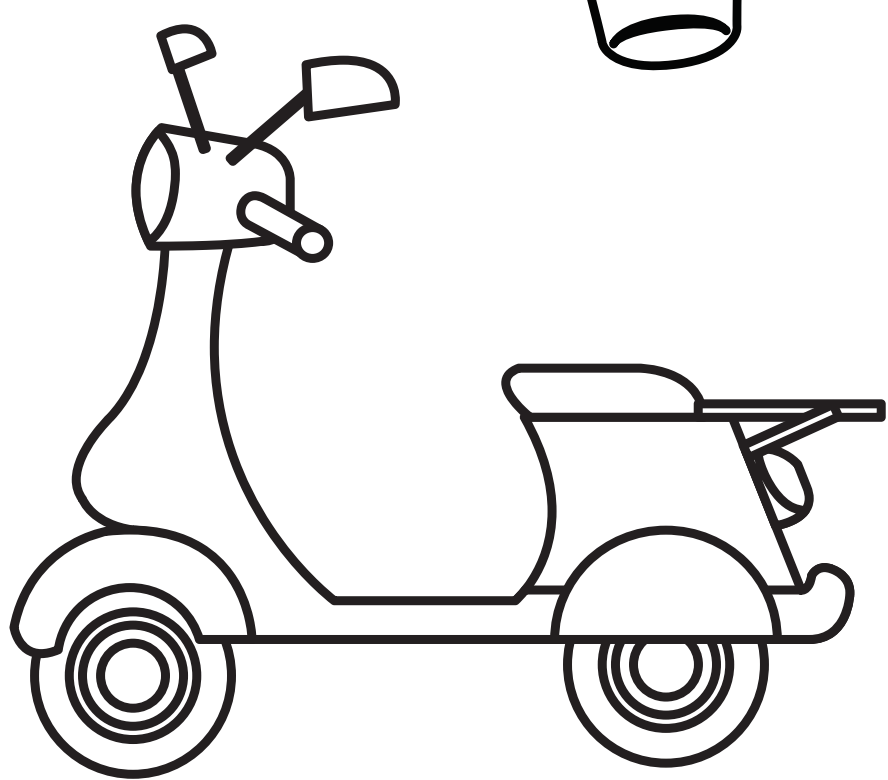
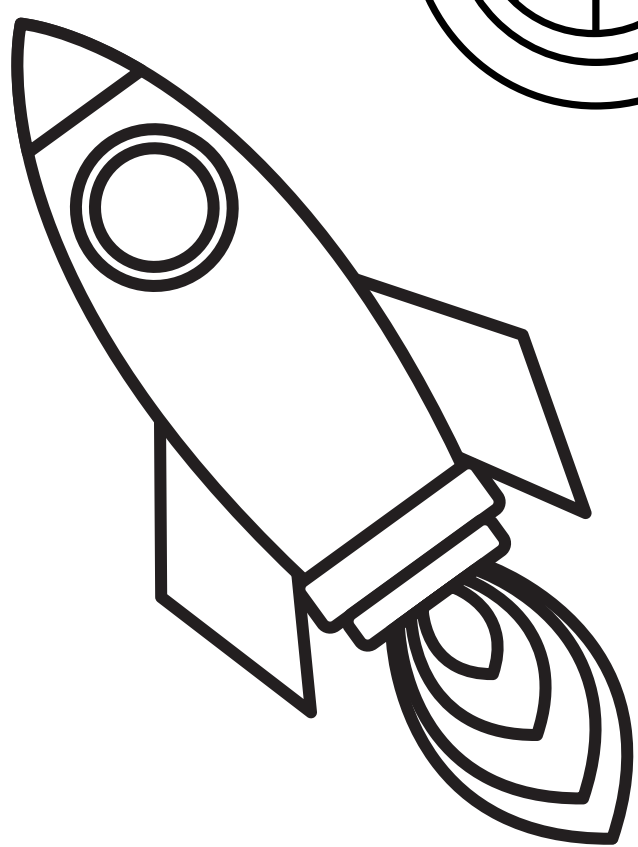
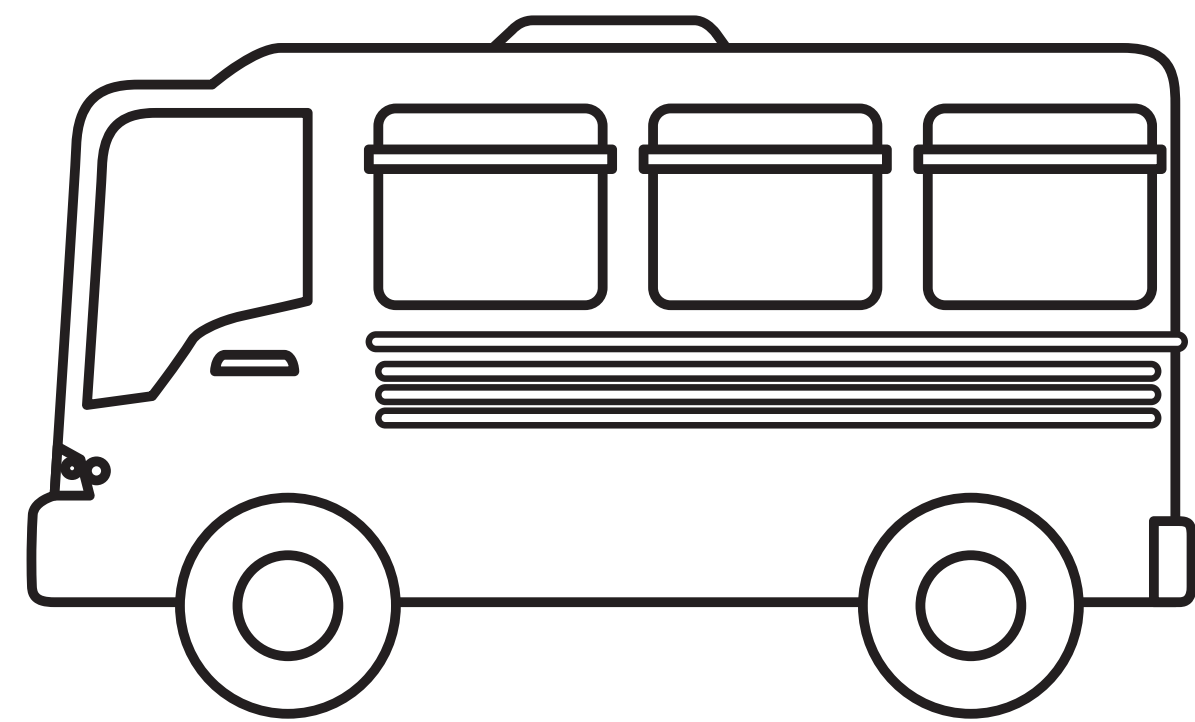
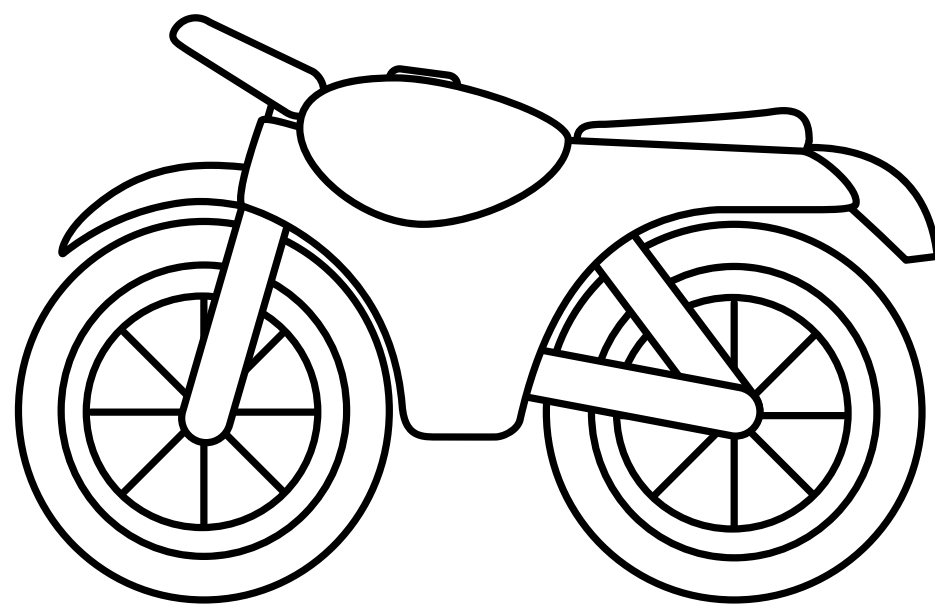
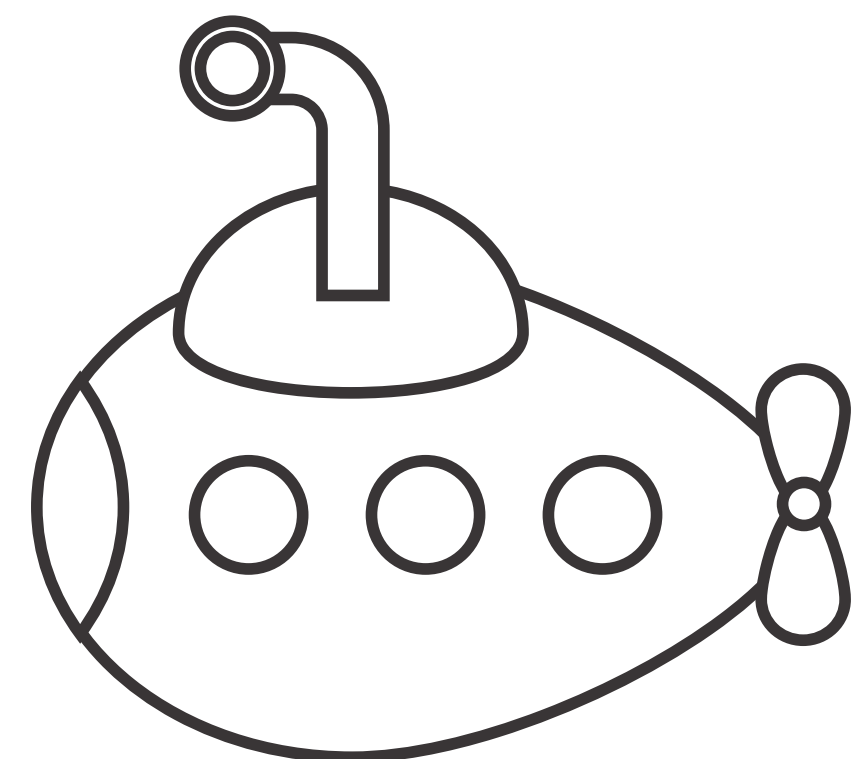
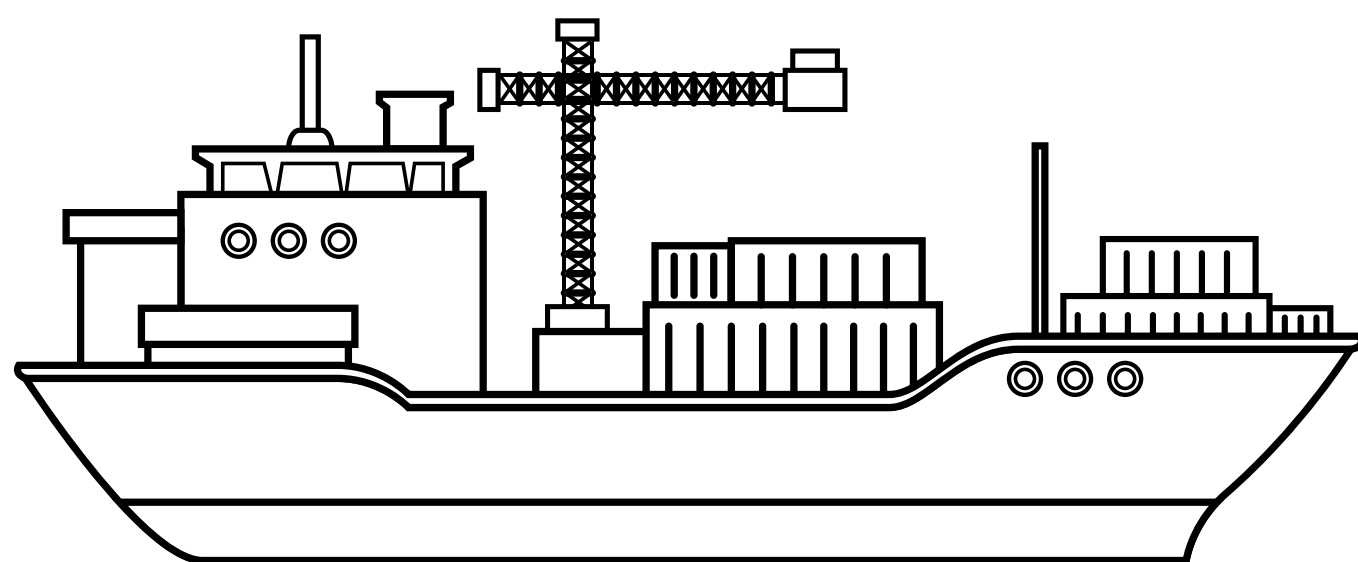
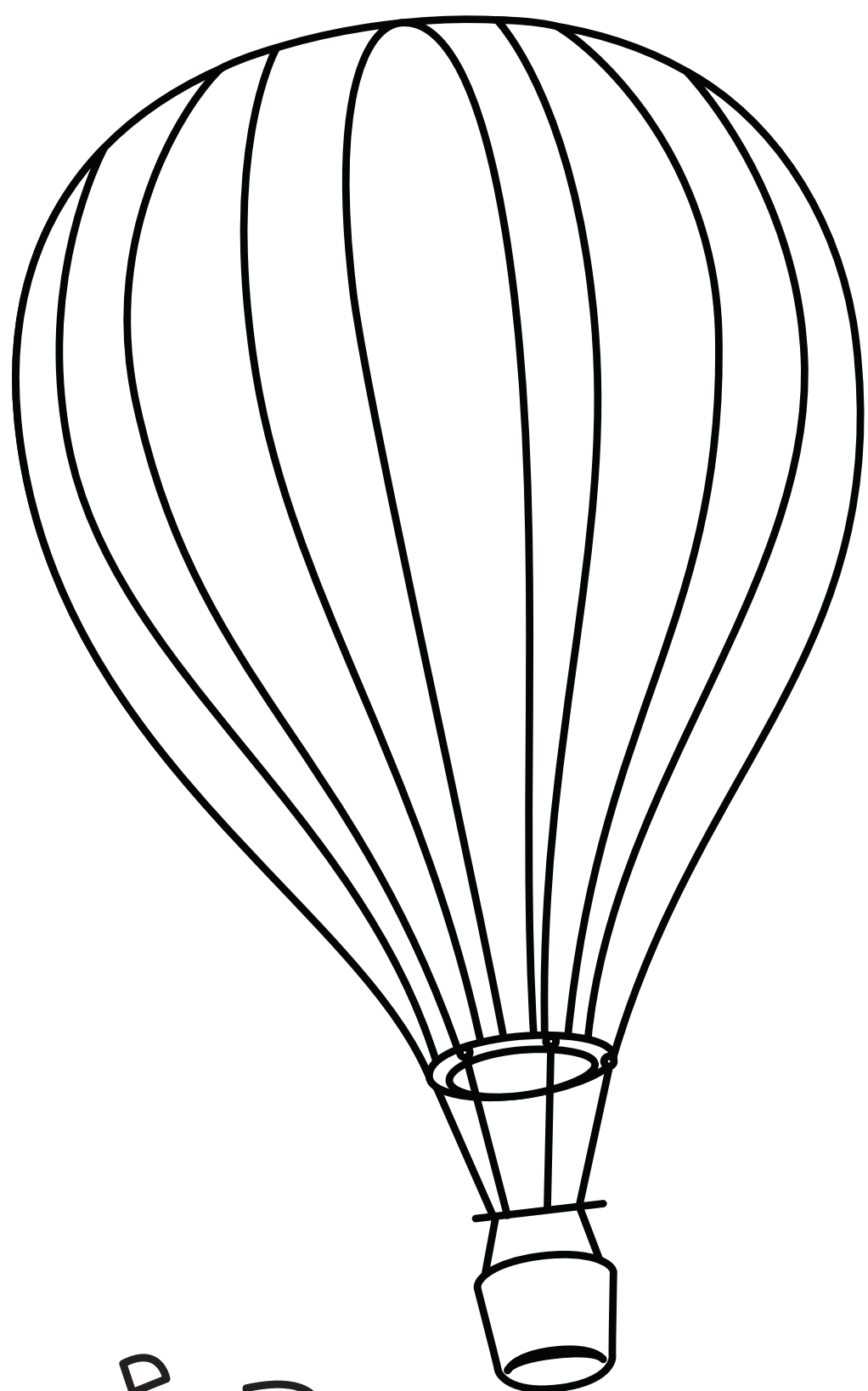
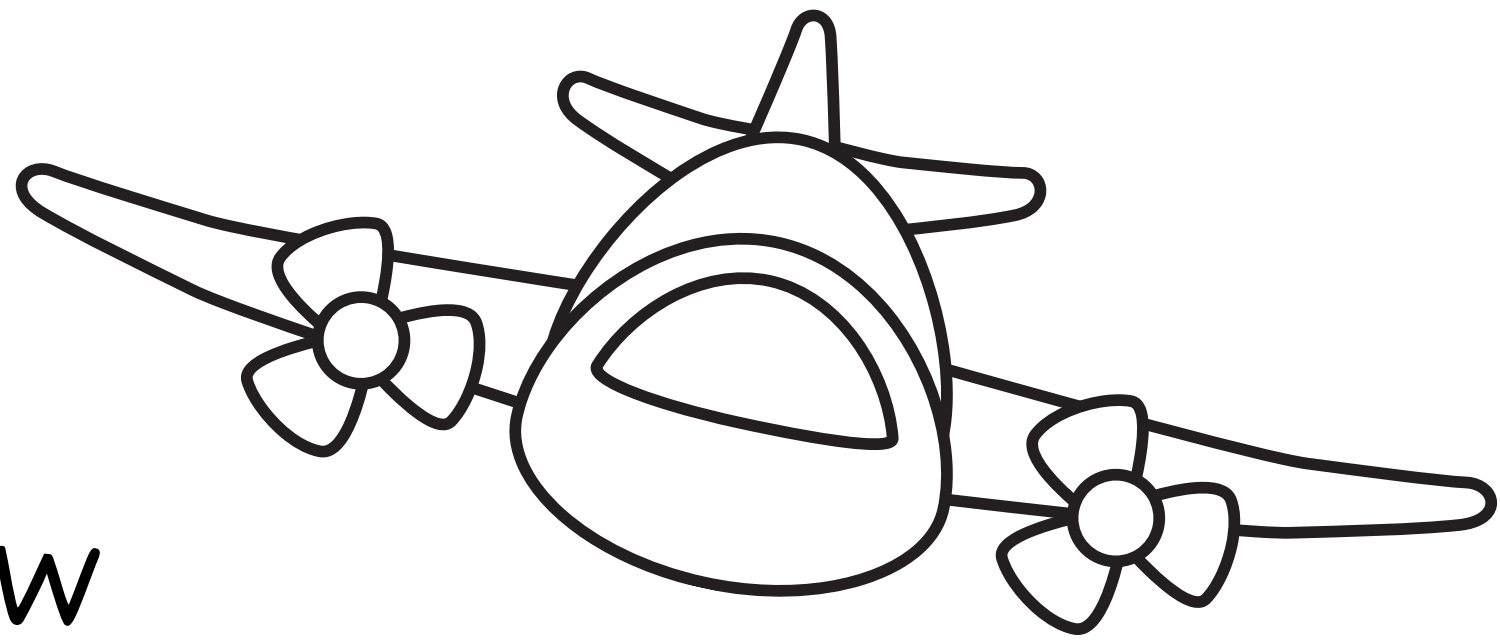



MISSING VOWELS

Fill in the missing vowels for each word:

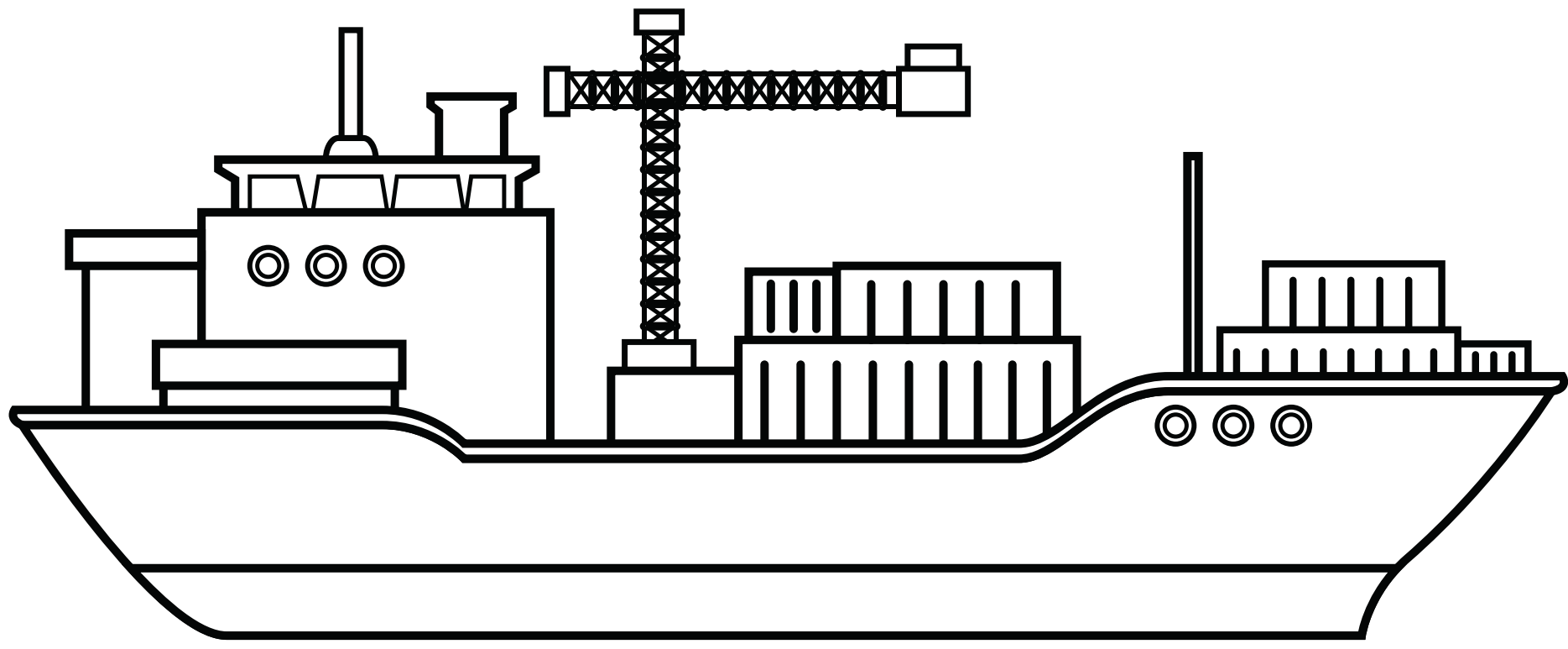

sh _ p

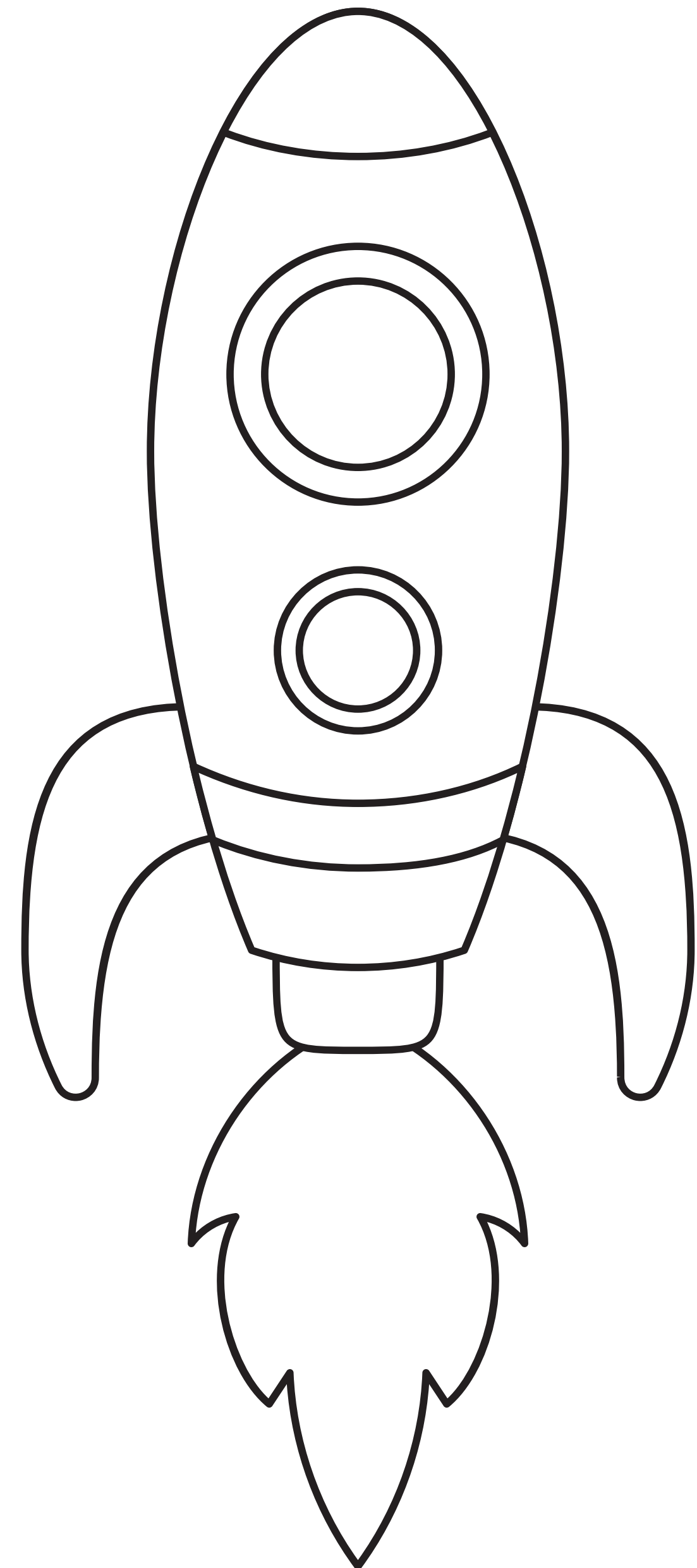

r _ cket

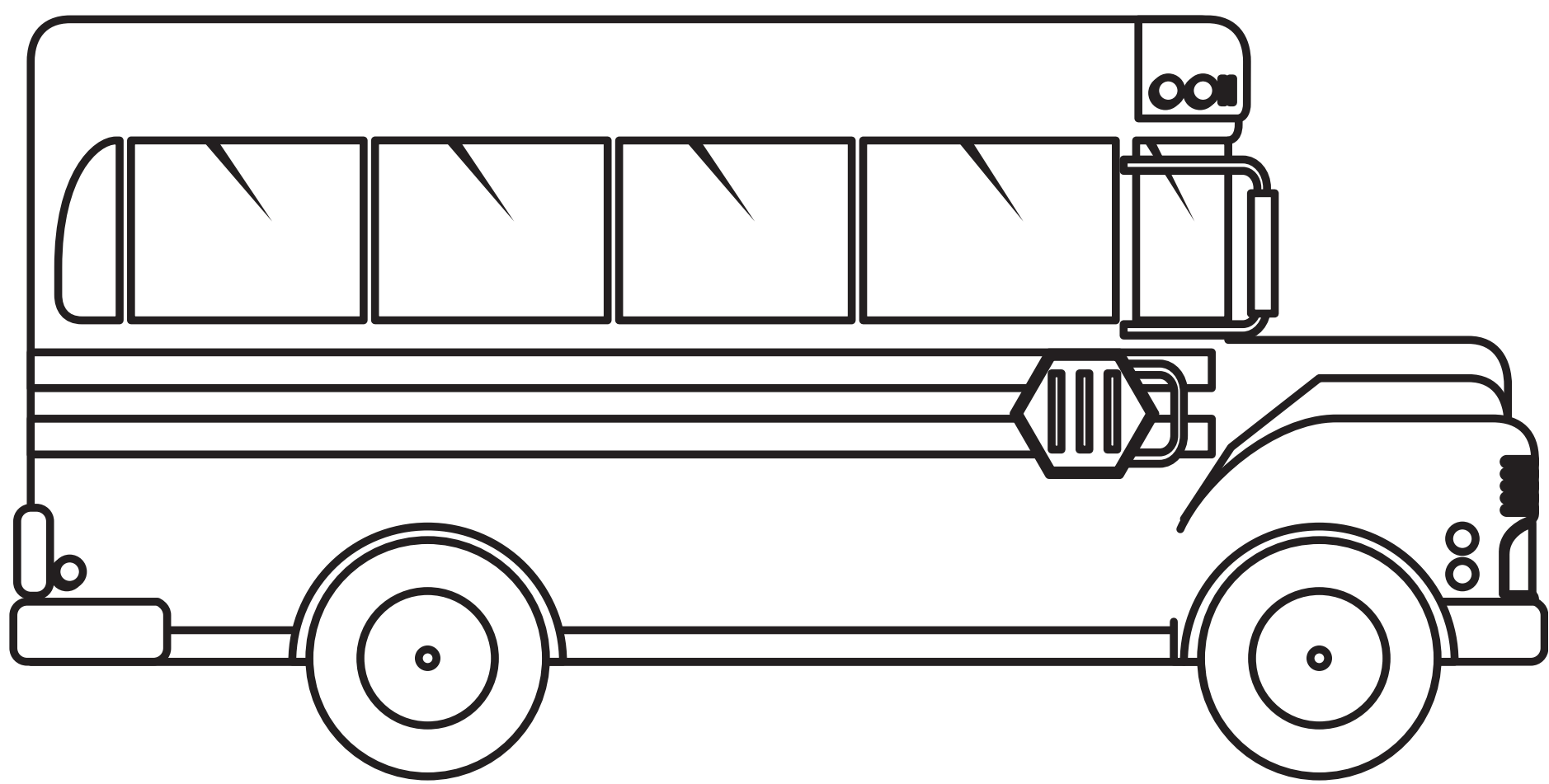

b _ s

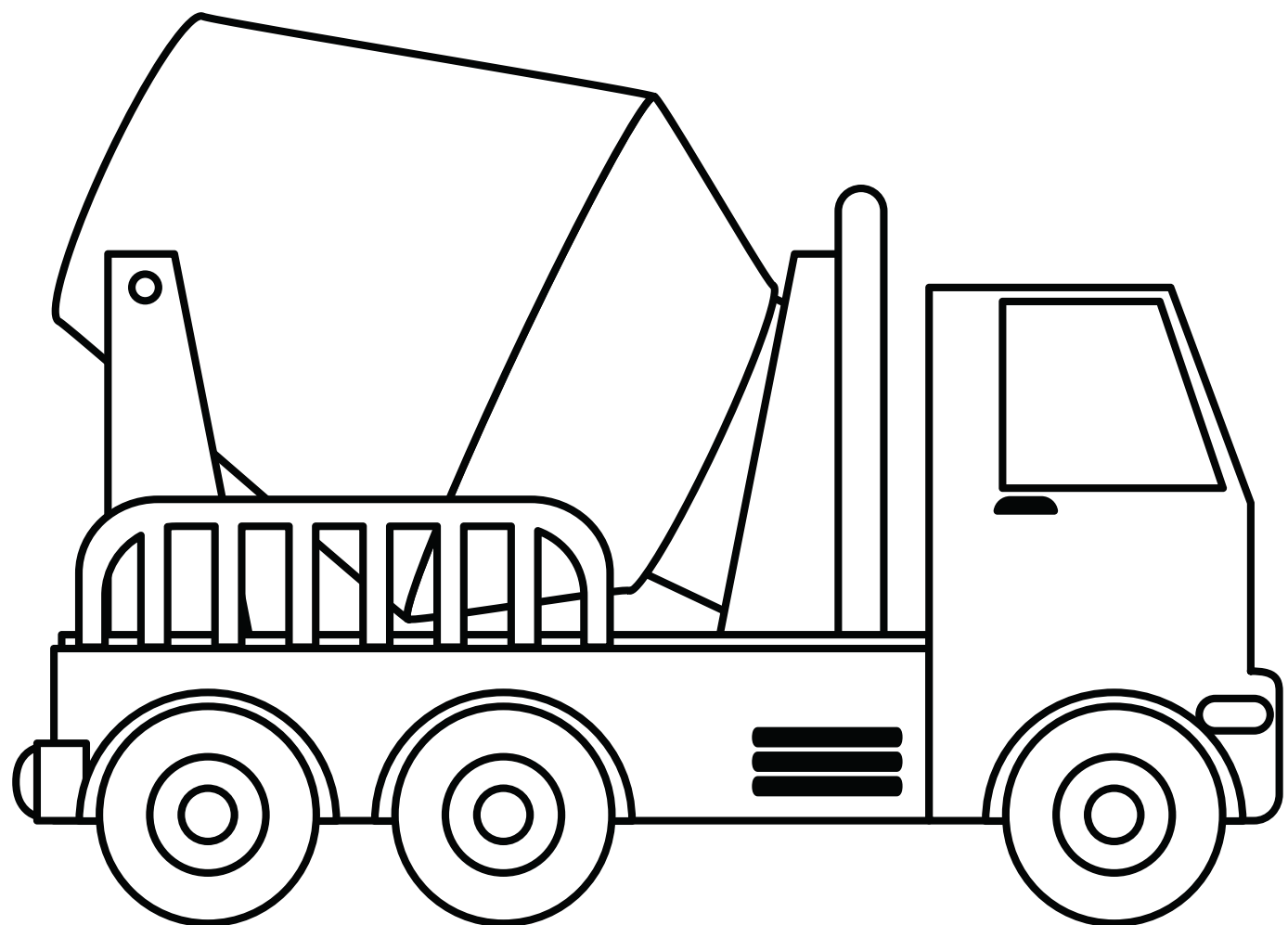

tr _ ck

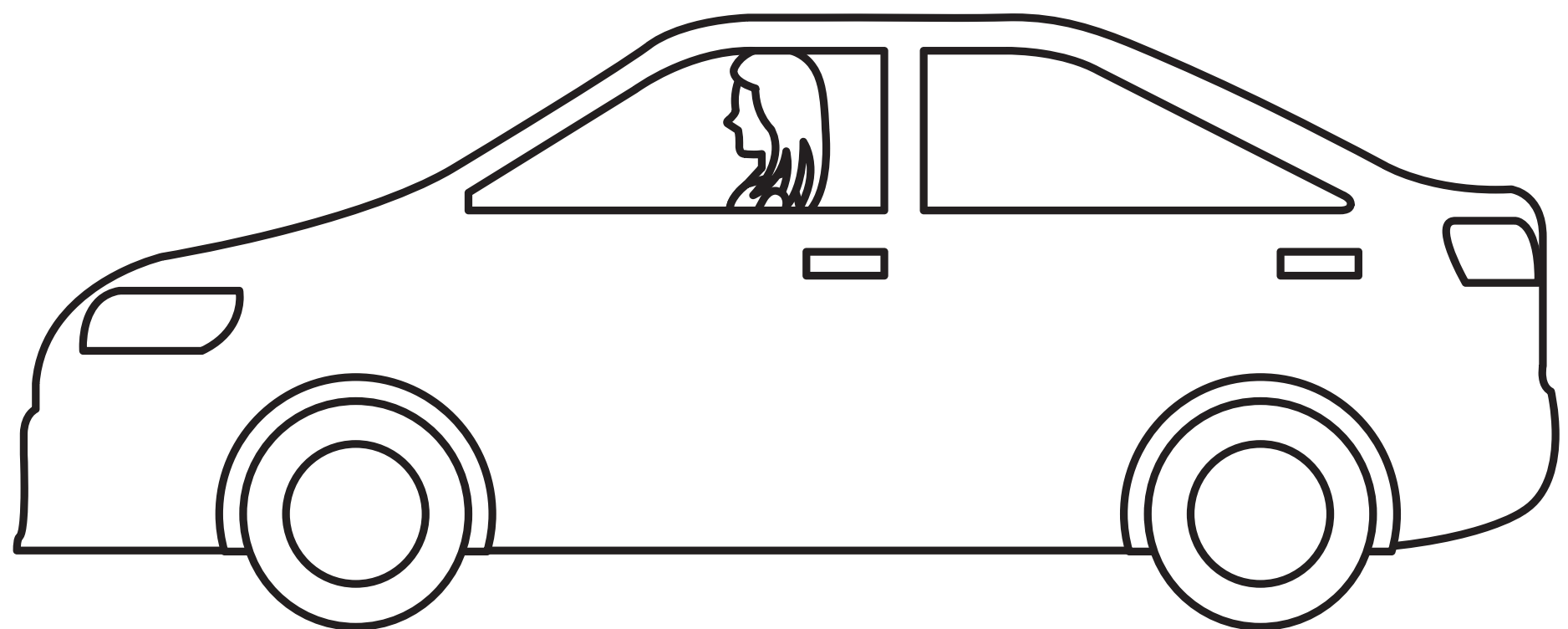

c _ r



SPELLING BOXES

Use the boxes to spell each word:

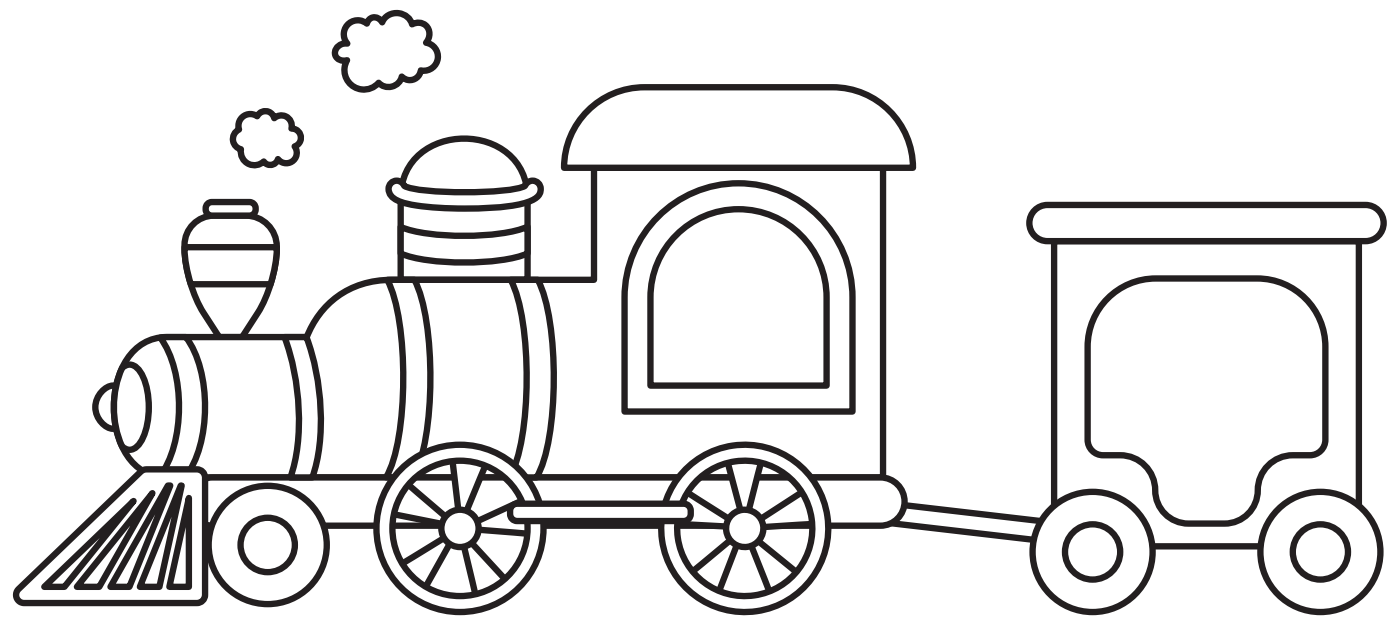

--	--	--	--	--

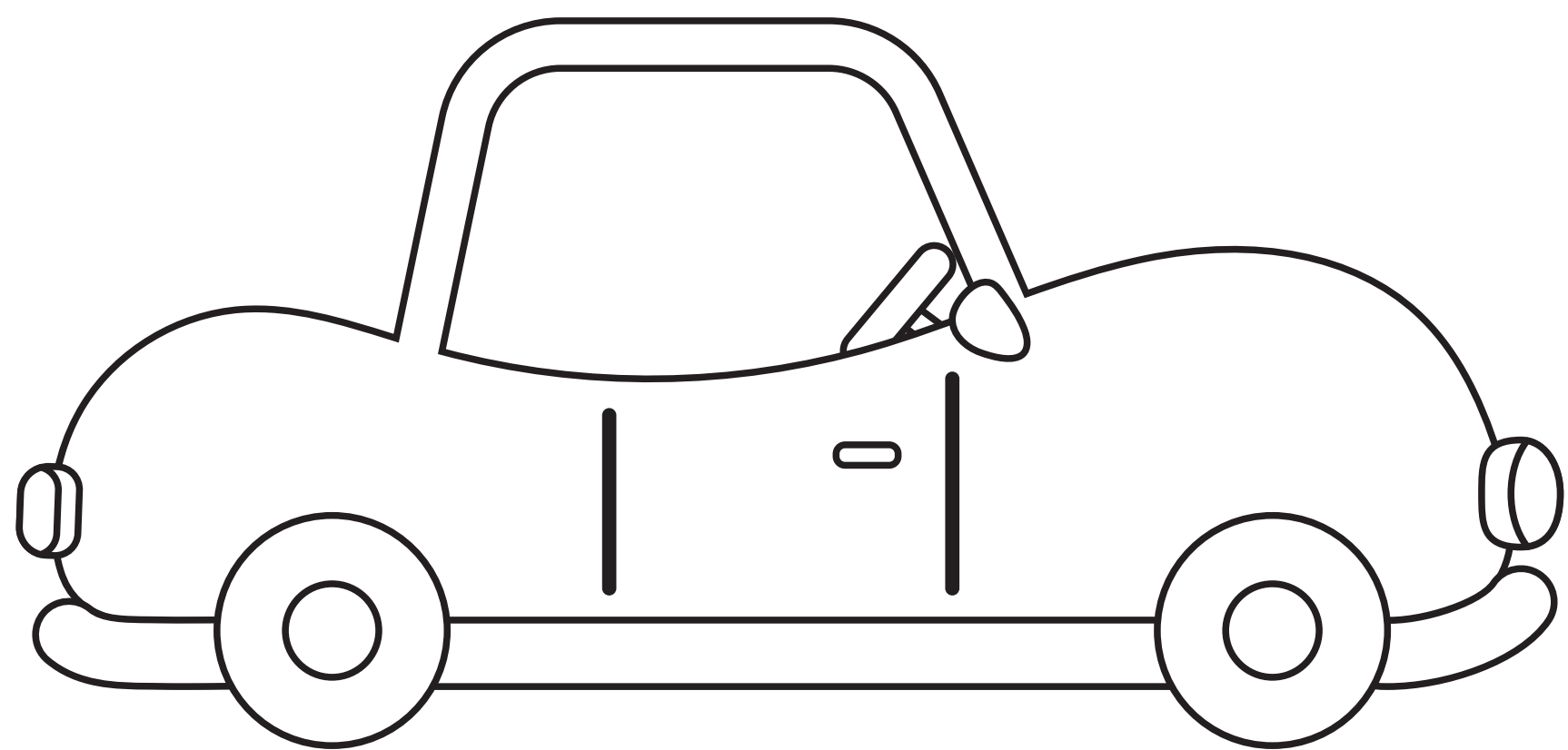

--	--	--

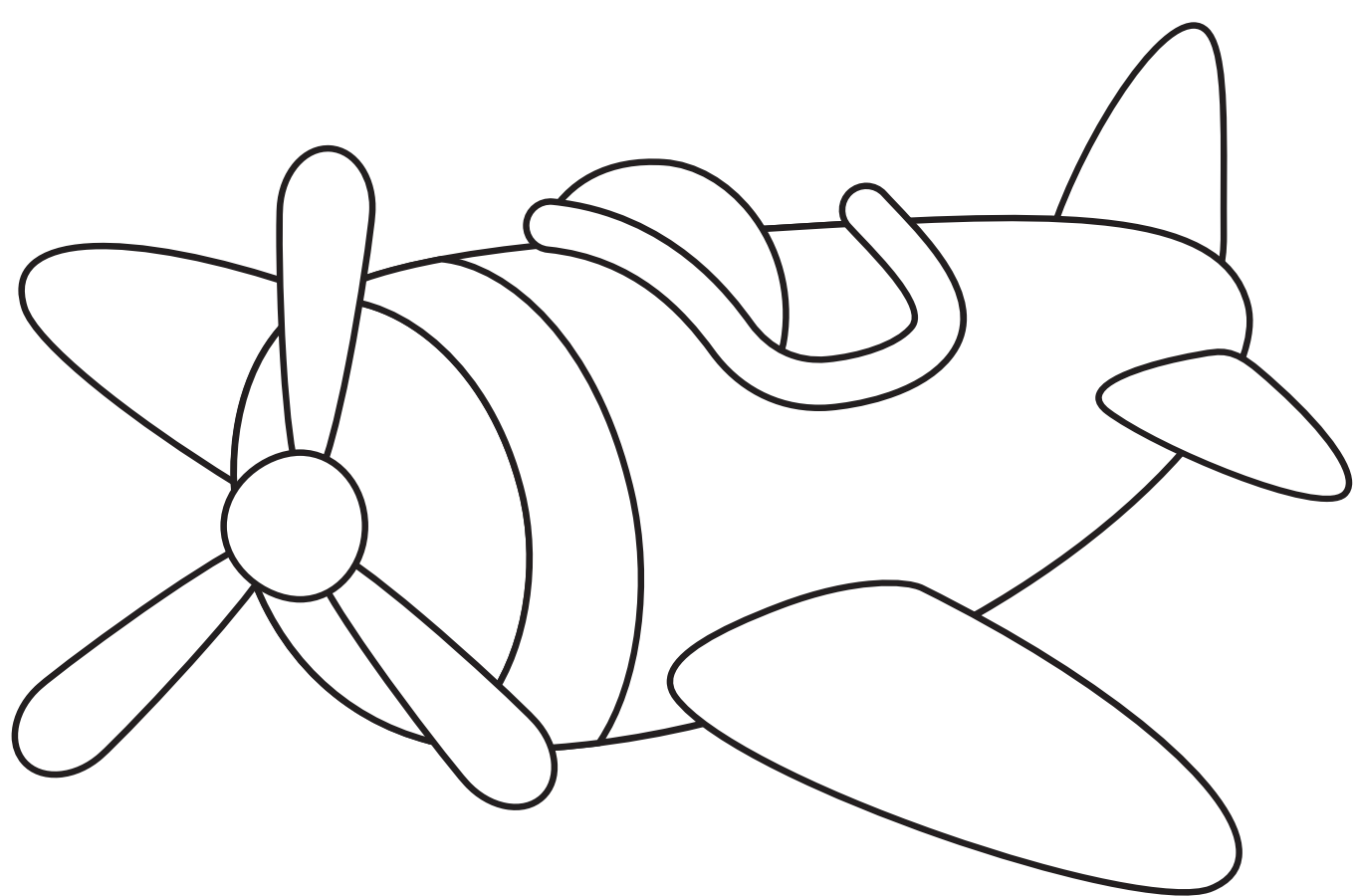

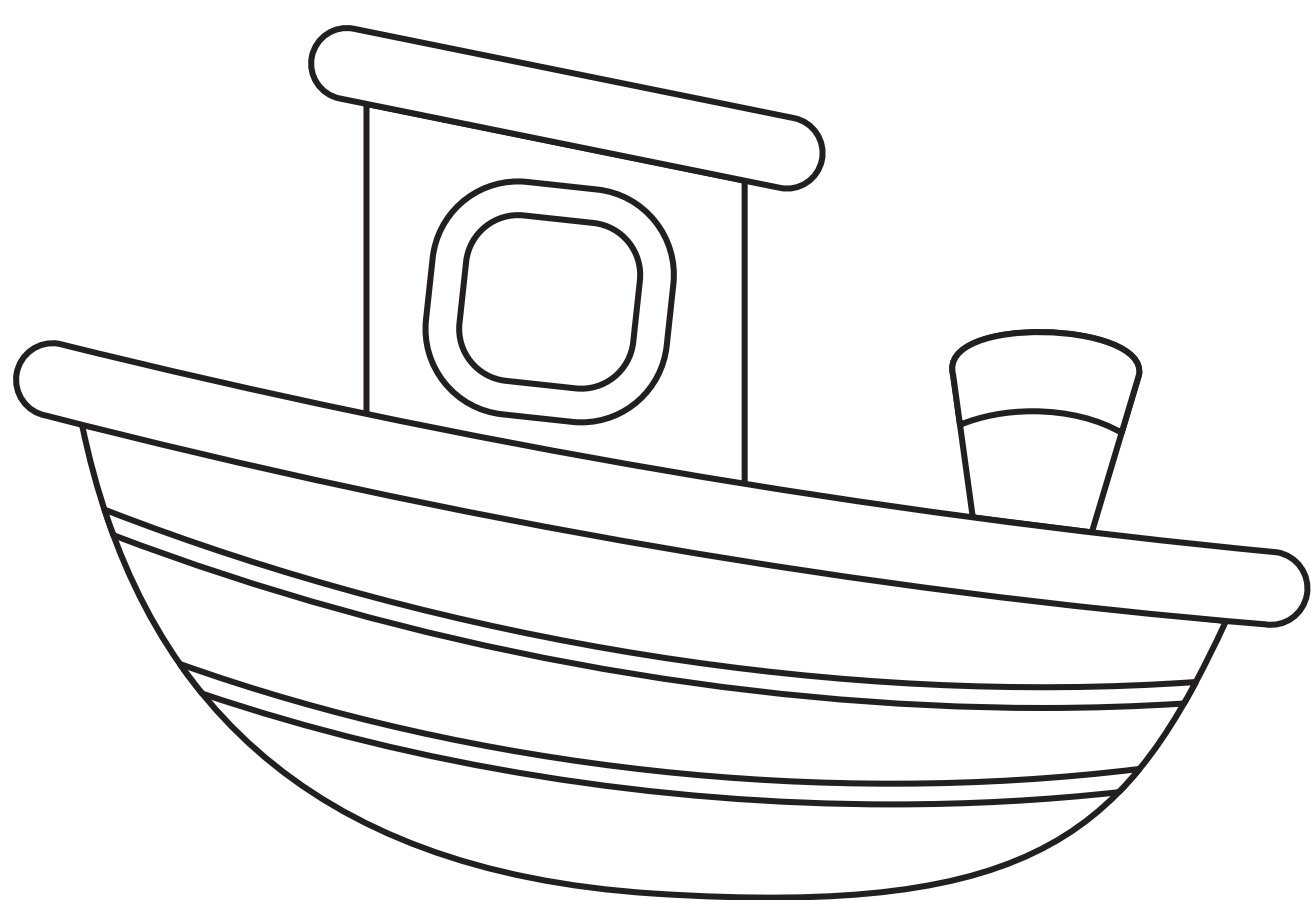

--	--	--	--

NEED FOR SPEED

Colour the mode of transport which is the faster in the pair:

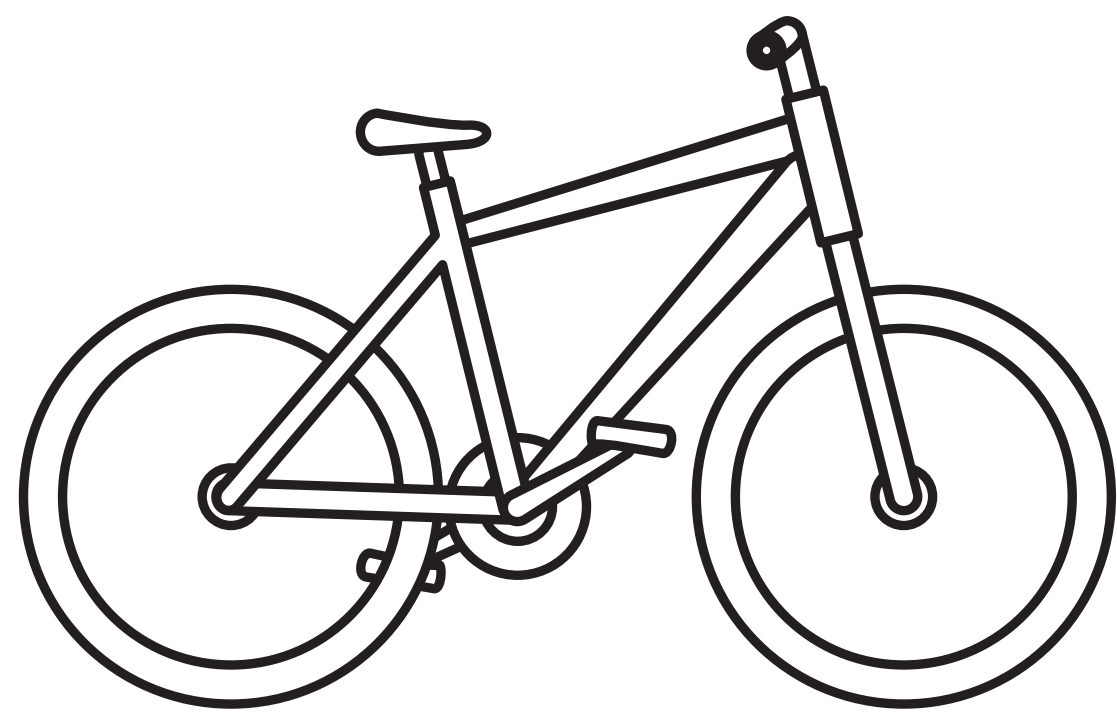

bike



pram

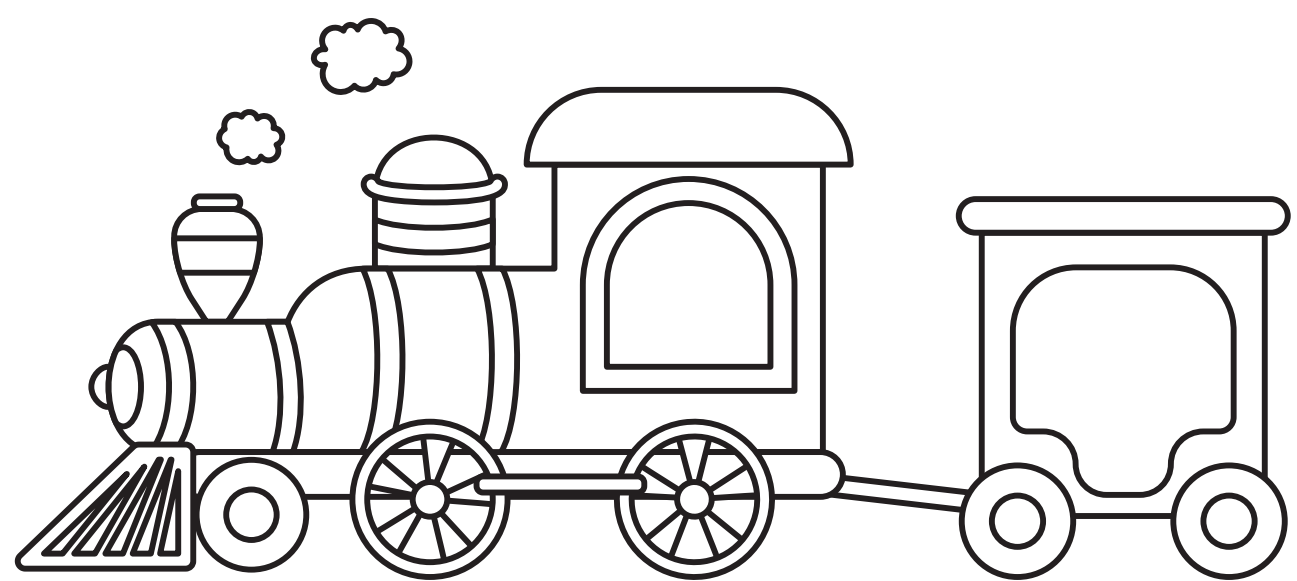

train

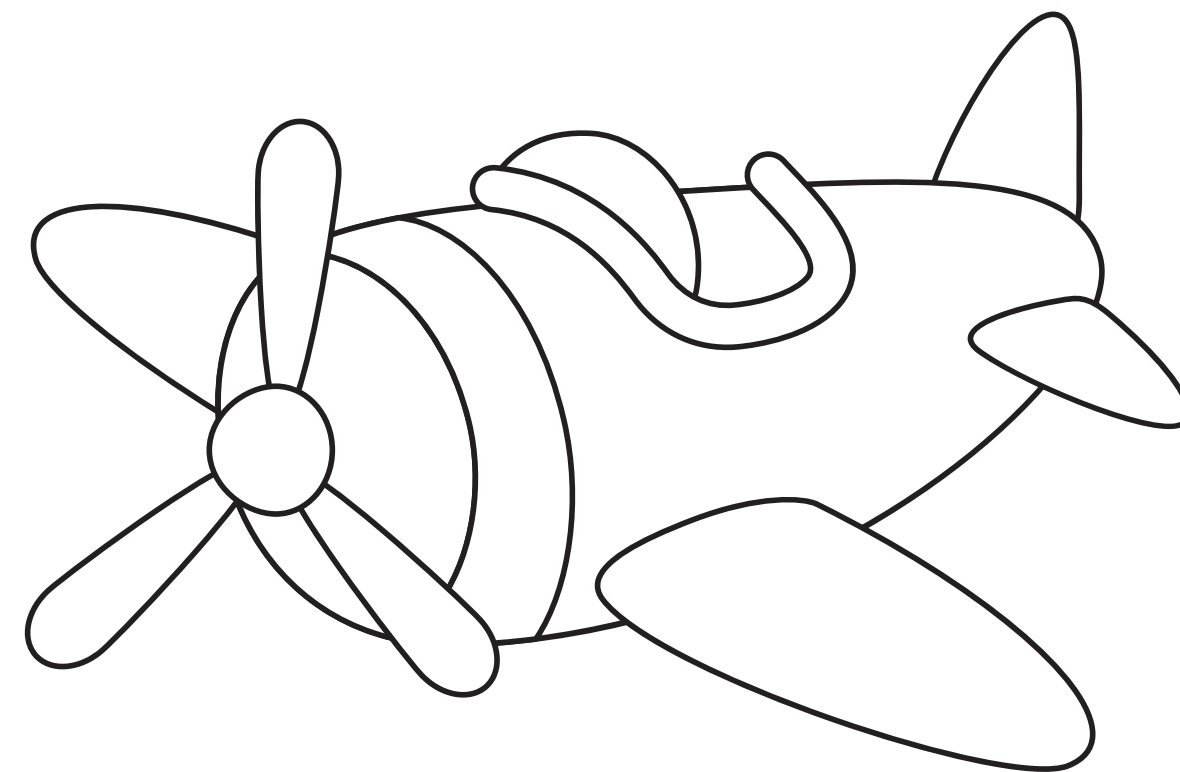

aeroplane

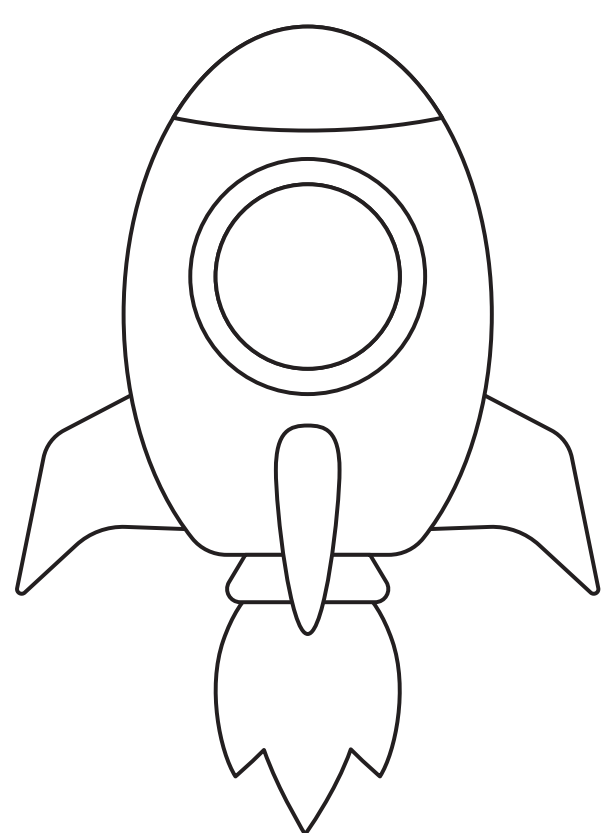

rocket

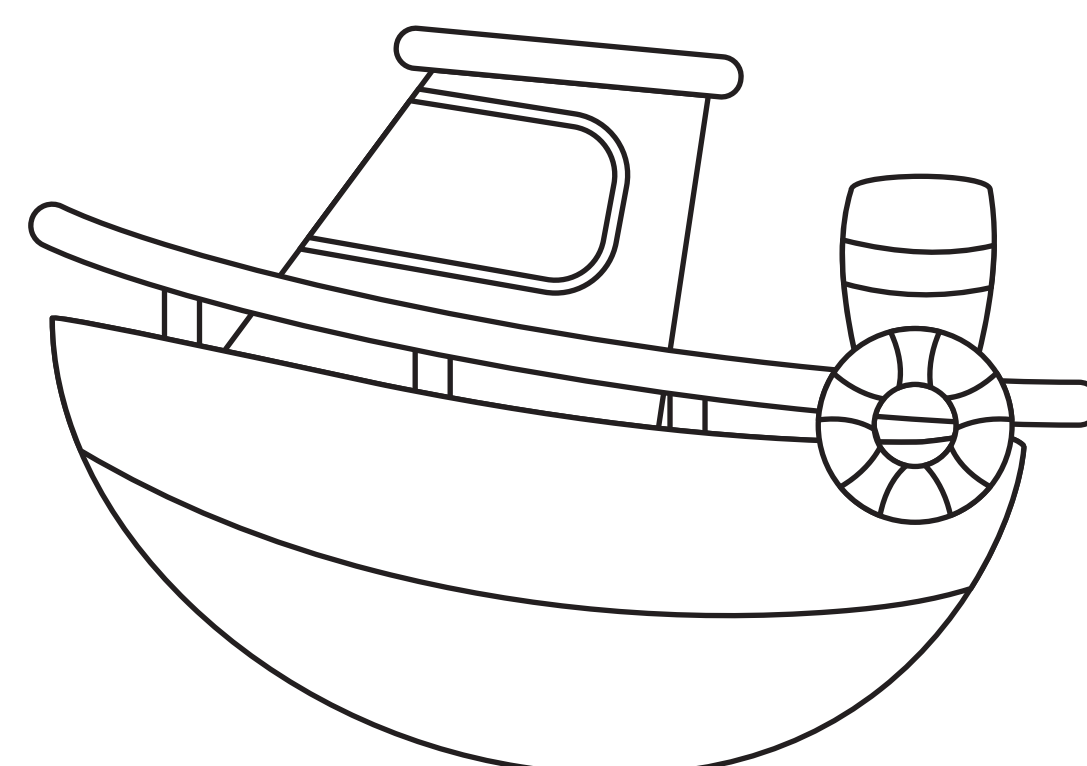

boat



WORD SEARCH

B	C	A	H	T	A	M	B
P	I	H	S	N	T	R	U
R	F	K	C	A	R	R	S
O	T	E	E	A	A	E	L
T	E	R	R	Z	M	T	E
C	K	N	U	R	R	O	N
A	C	Y	A	C	Y	O	A
R	O	C	O	O	K	C	L
T	R	A	I	N	N	S	P

- | | |
|---------|---------|
| car | bike |
| tram | scooter |
| tractor | ship |
| train | ferry |
| bus | rocket |
| plane | truck |

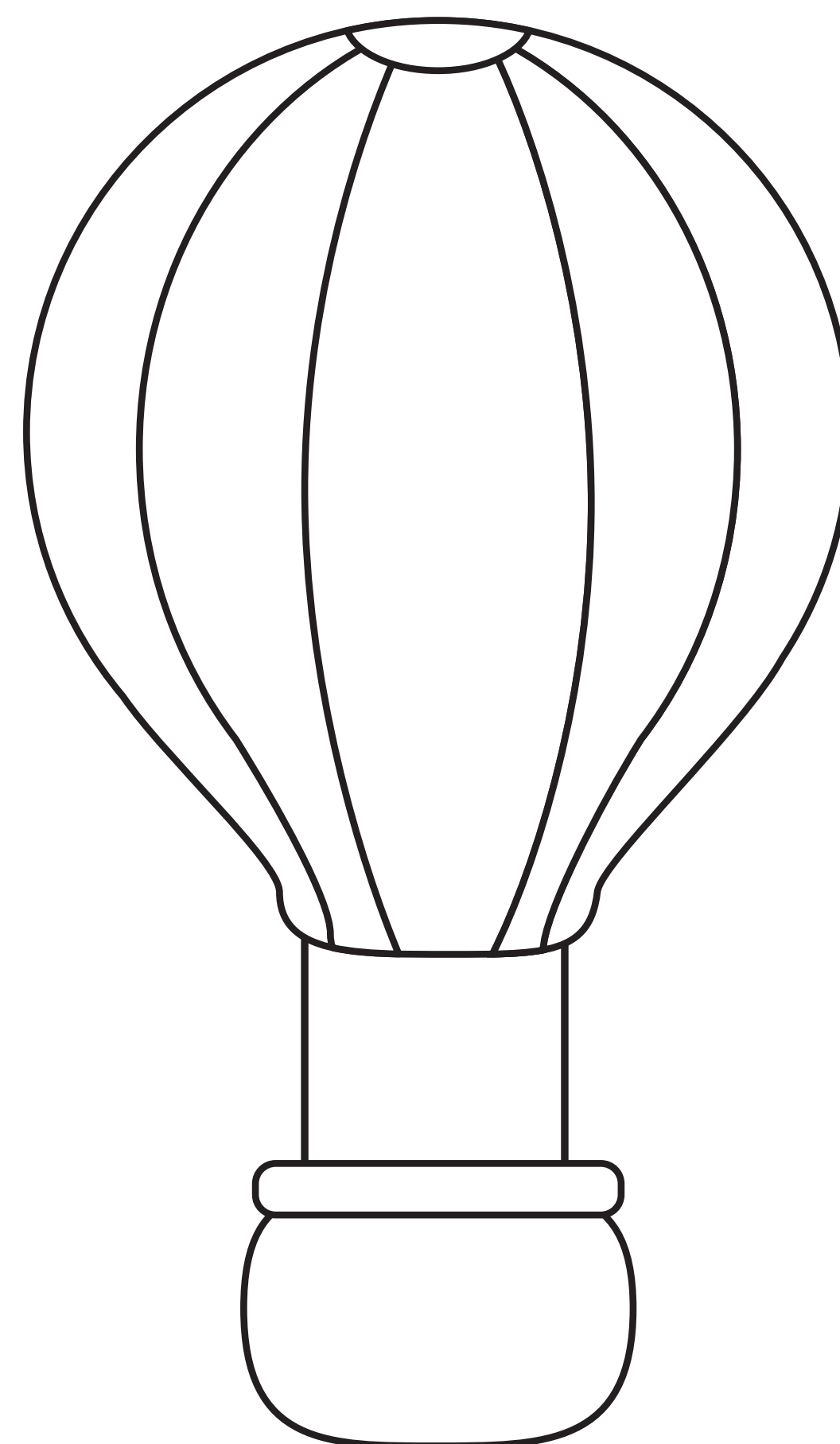



COLOUR BY NUMBER

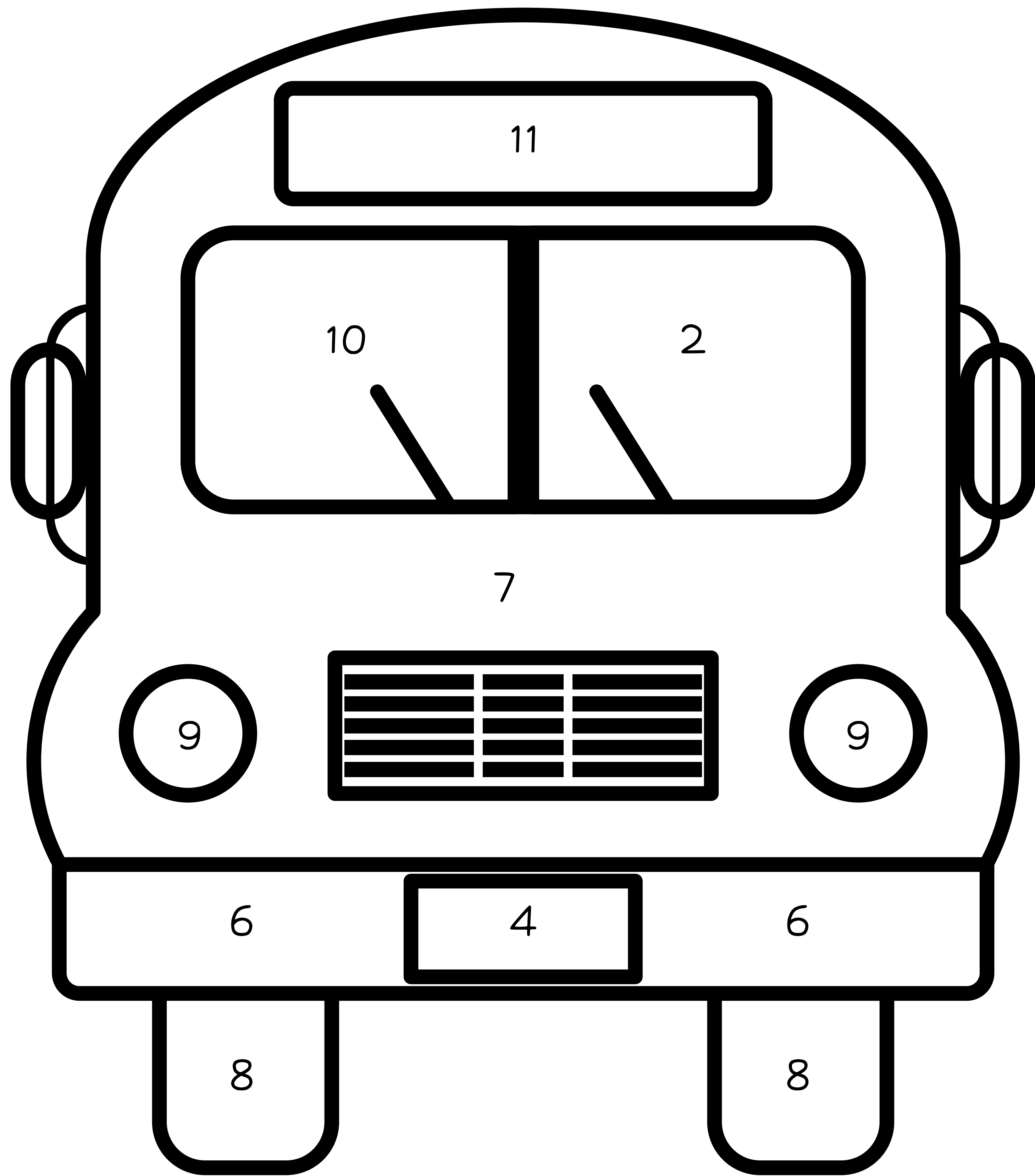

$3 + 3 = \text{blue}$

$2 + 2 = \text{red}$

$5 + 2 = \text{yellow}$

$5 + 5 = \text{purple}$

$4 + 5 = \text{orange}$

$1 + 1 = \text{pink}$

$9 + 2 = \text{green}$

$4 + 4 = \text{black}$



DRAWING

Draw a scene that includes four different modes of transport: