

# CABINA DI VERNICIATURA FAI DA TE



In questo PDF trovi tutte le informazioni e le misure per realizzare una cabina di verniciatura fai da te.



Foto dei dettagli, misure e configurazione dei vari pezzi che la compongono.

Consigli indispensabili per fare sempre un ottimo lavoro e non sbagliare riparamiando tempo e denaro.

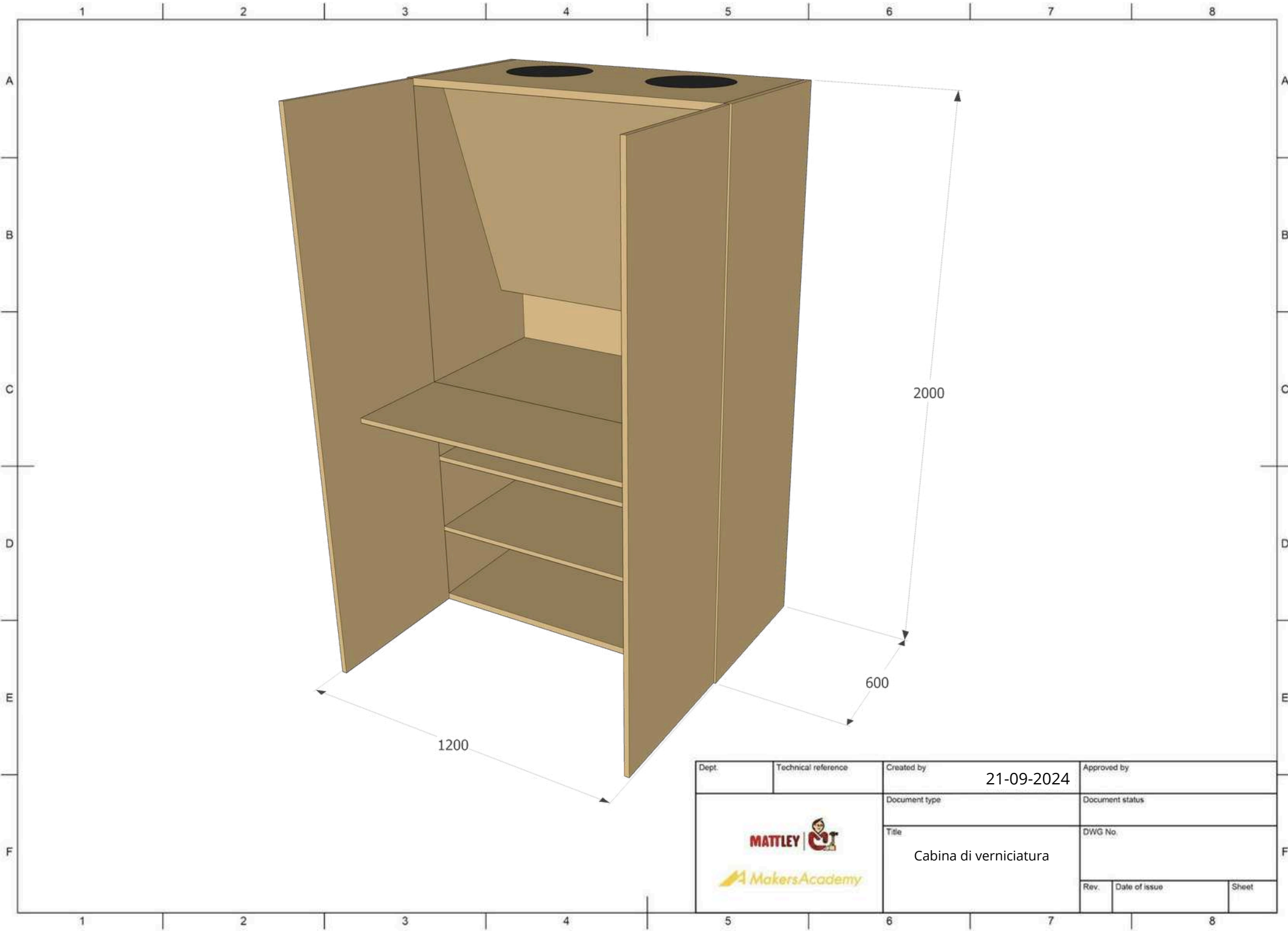

# CABINA DI VERNICIATURA FAI DA TE





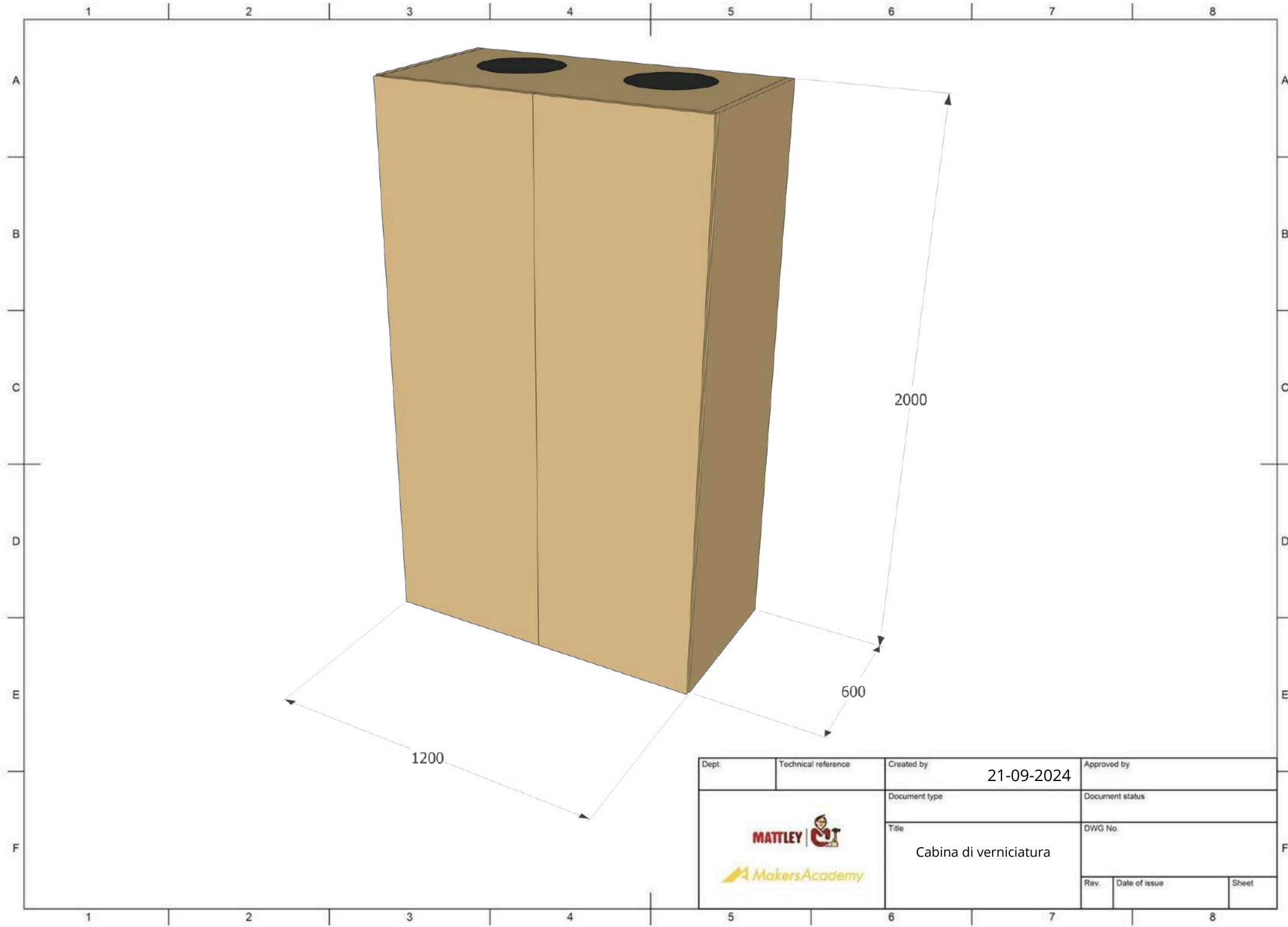

Dept.	Technical reference	Created by	21-09-2024	Approved by
 		Document type	Document status	
		Title	Cabina di verniciatura	
Rev.	Date of issue	Sheet		

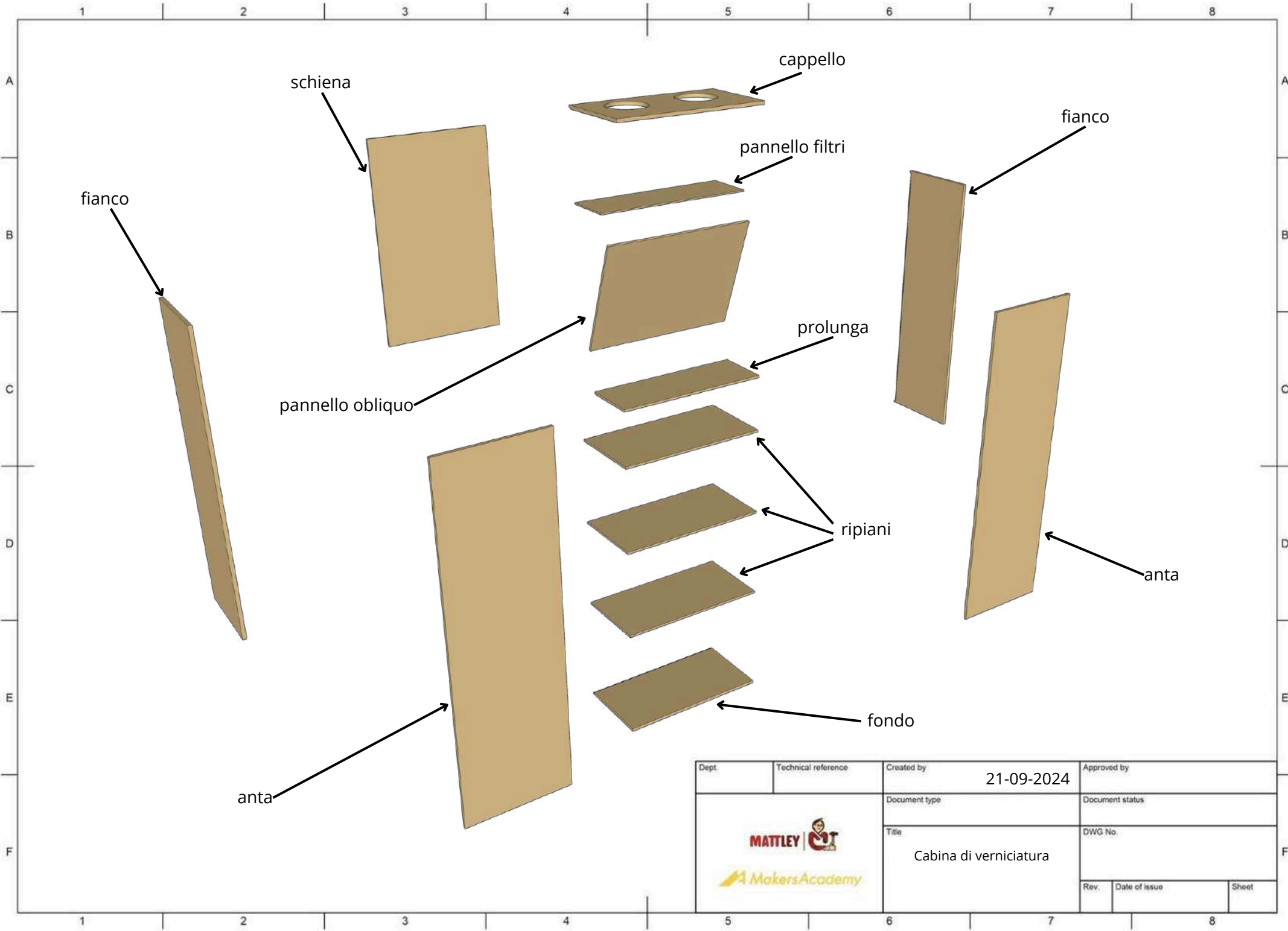

Dept.	Technical reference	Created by	21-09-2024	Approved by
 		Document type	Document status	
		Title	DWG No.	
		Cabina di verniciatura		
Rev.	Date of issue	Sheet		



Dept.	Technical reference	Created by	21-09-2024	Approved by
 		Document type	Document status	
		Title	DWG No.	
		Cabina di verniciatura		
Rev.	Date of issue	Sheet		

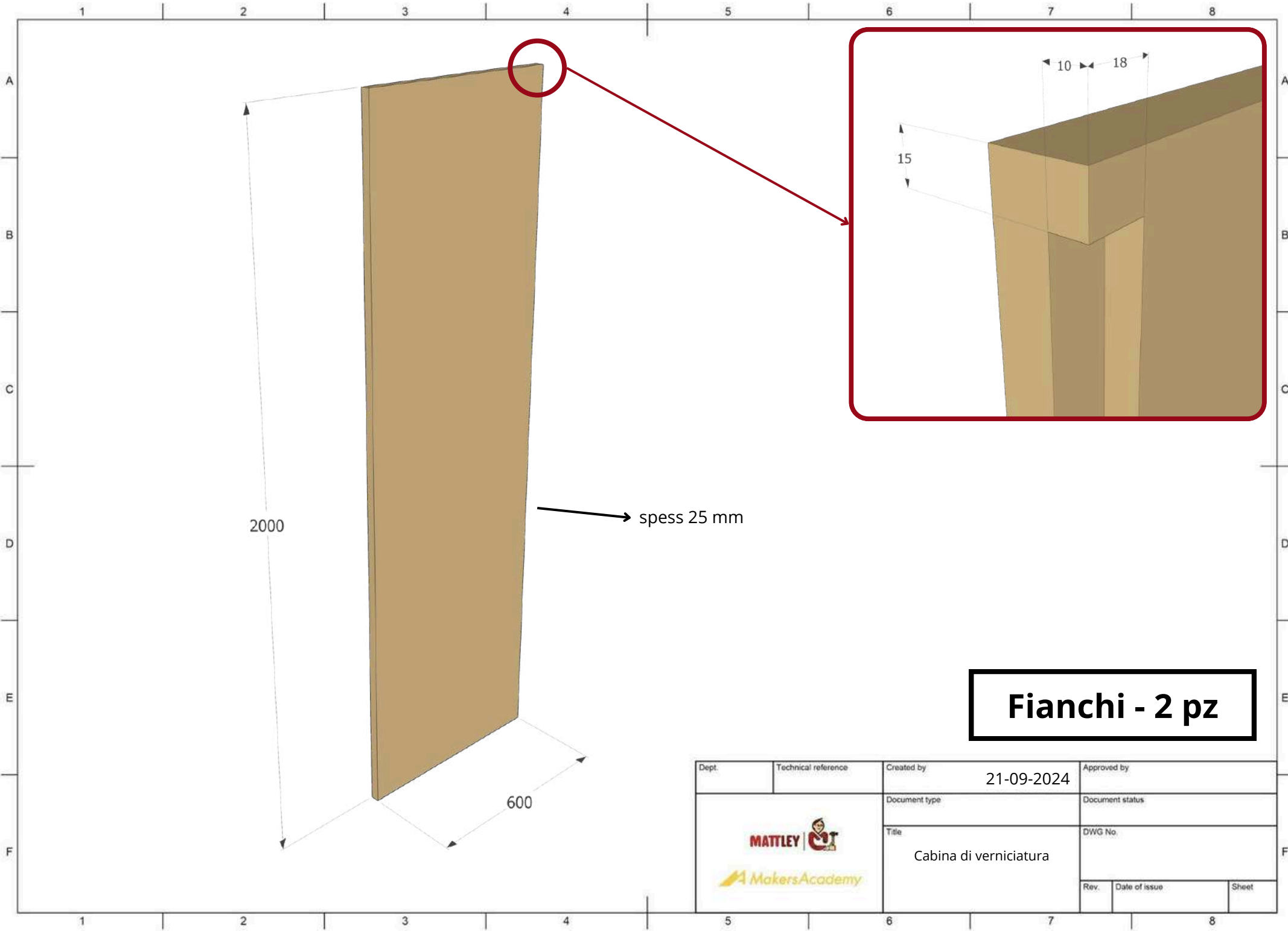

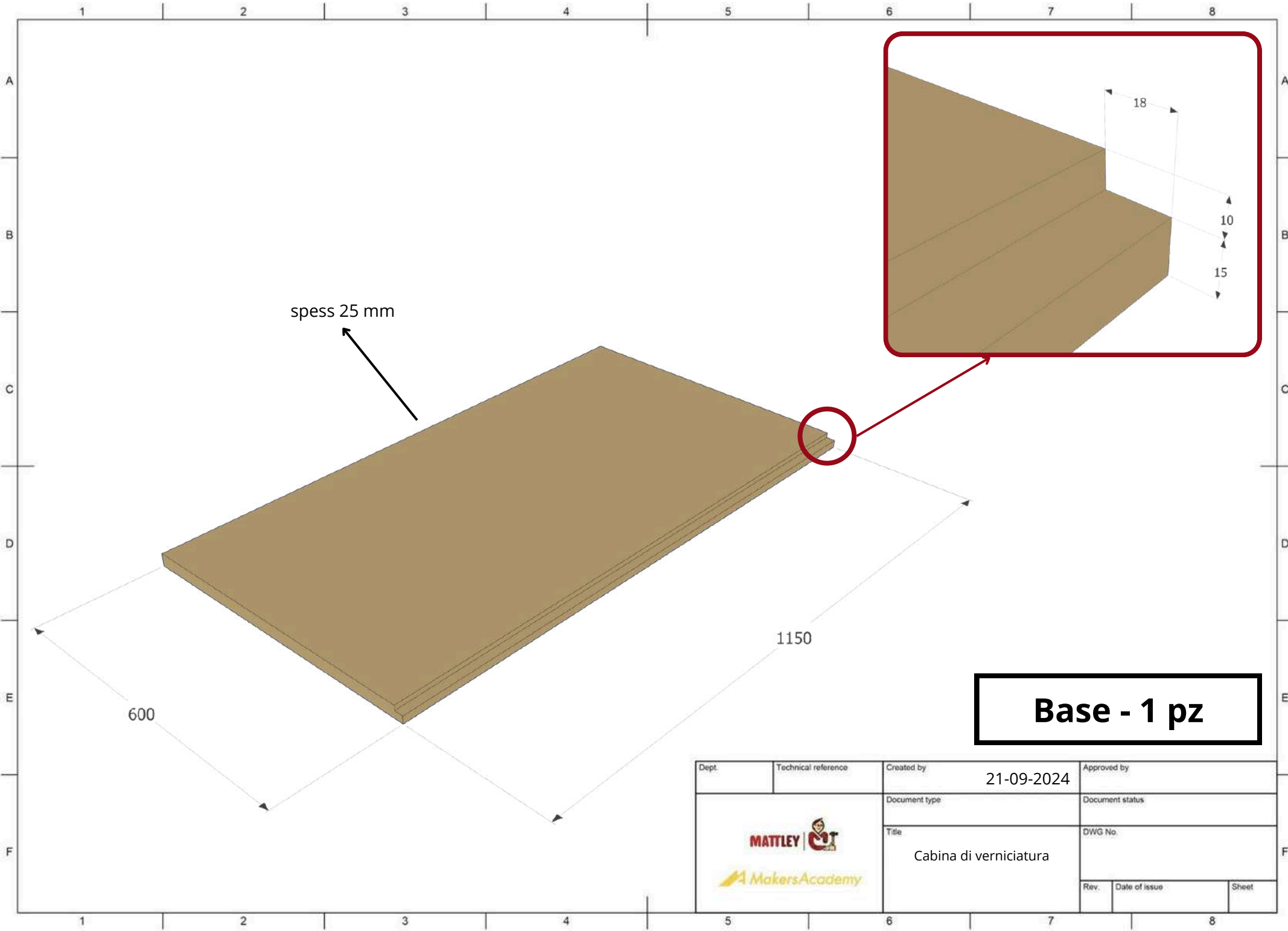

**Fianchi - 2 pz**

Dept.	Technical reference	Created by	21-09-2024	Approved by
		Document type	Document status	
		Title	DWG No.	
		Cabina di verniciatura		
Rev.	Date of issue	Sheet		



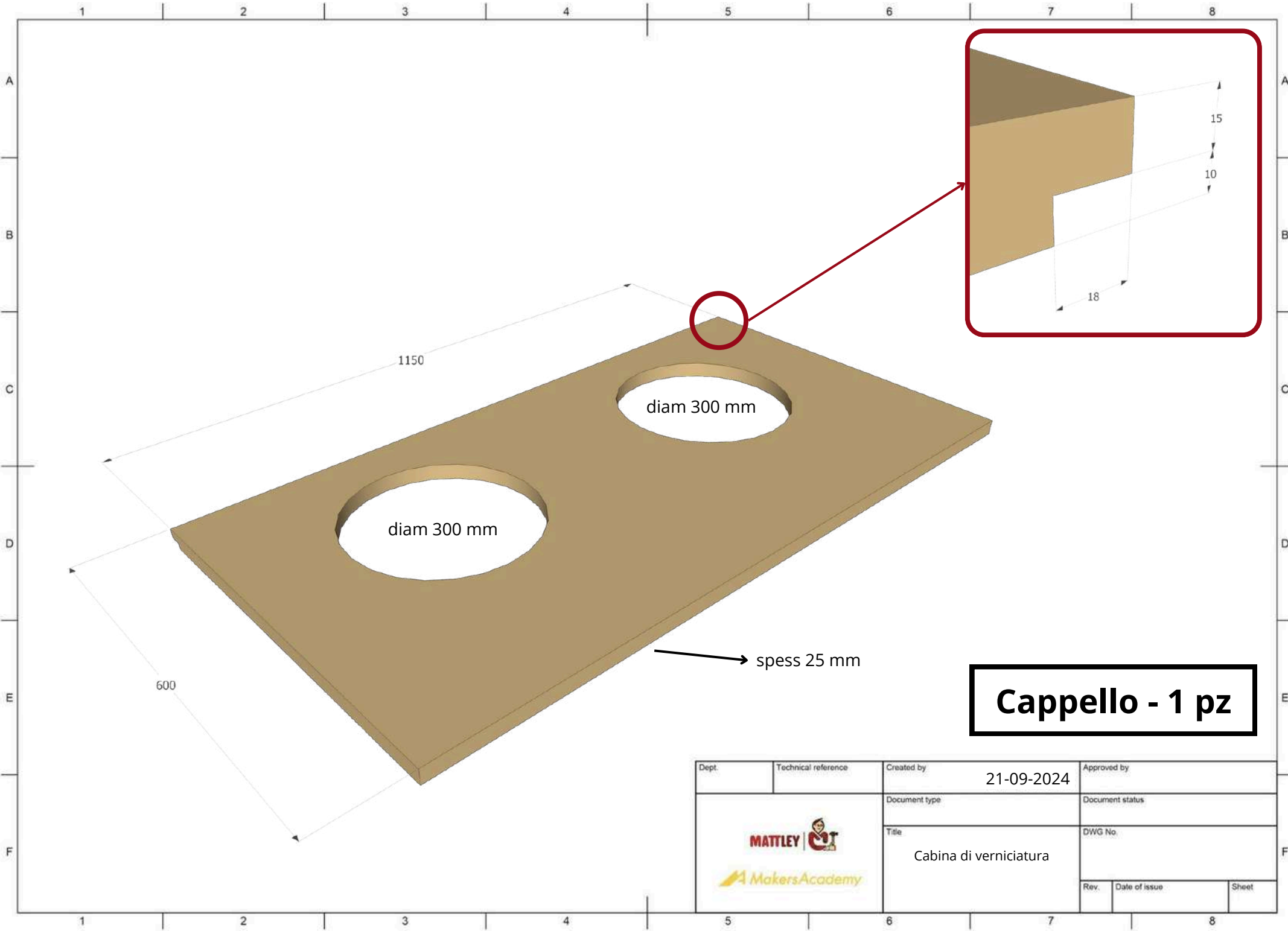

**Base - 1 pz**

Dept.	Technical reference	Created by	21-09-2024	Approved by
 		Document type	Document status	
		Title	DWG No.	
		Cabina di verniciatura		
Rev.	Date of issue	Sheet		



**Cappello - 1 pz**

Dept.	Technical reference	Created by	21-09-2024	Approved by
 		Document type	Document status	
		Title	DWG No.	
		Cabina di verniciatura		
Rev.	Date of issue	Sheet		

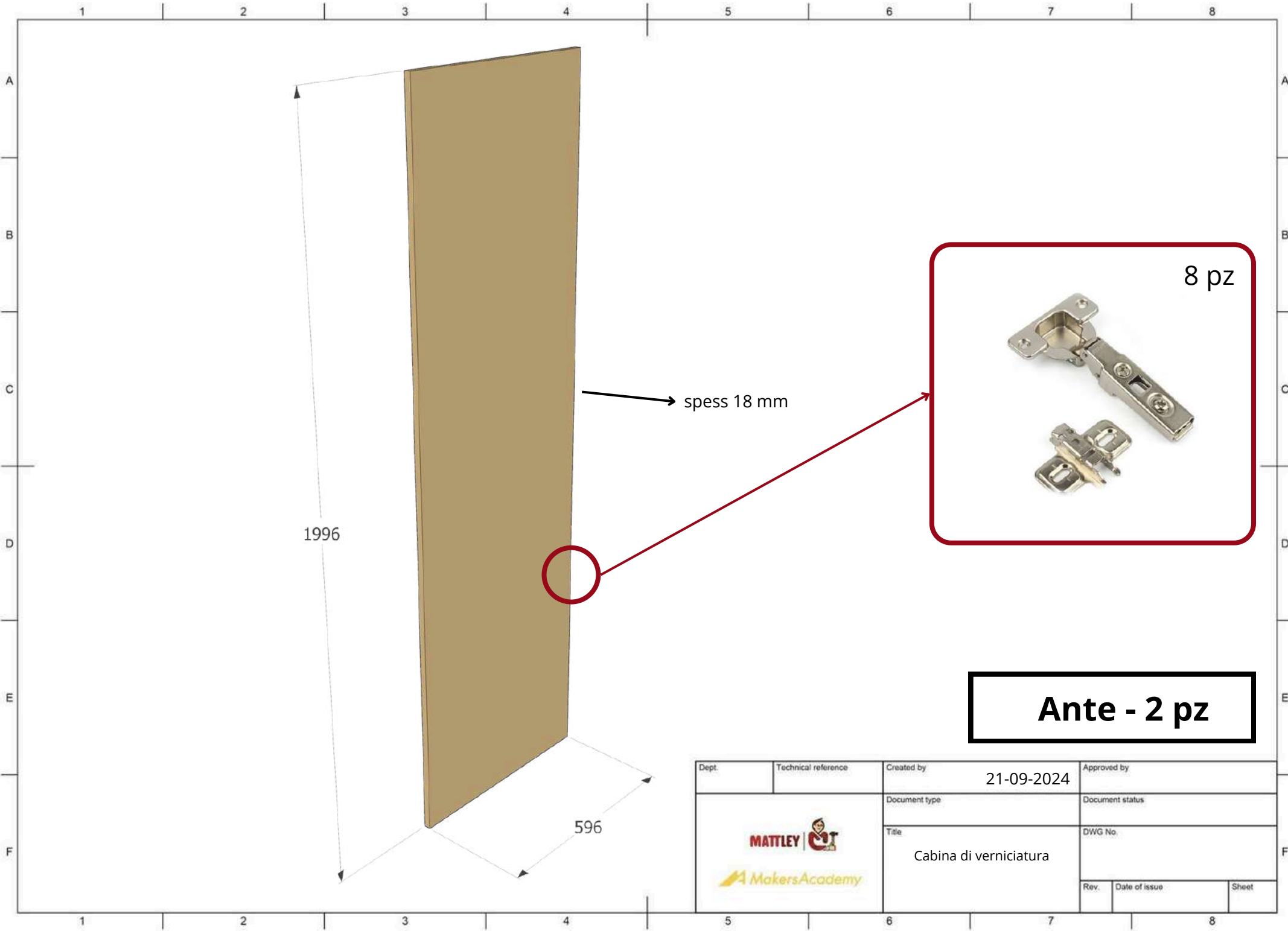



spess 18 mm

1996

596

**Ante - 2 pz**



Dept.	Technical reference	Created by	21-09-2024	Approved by
 		Document type	Document status	
		Title	DWG No.	
		Rev.	Date of issue	Sheet

Cabina di verniciatura

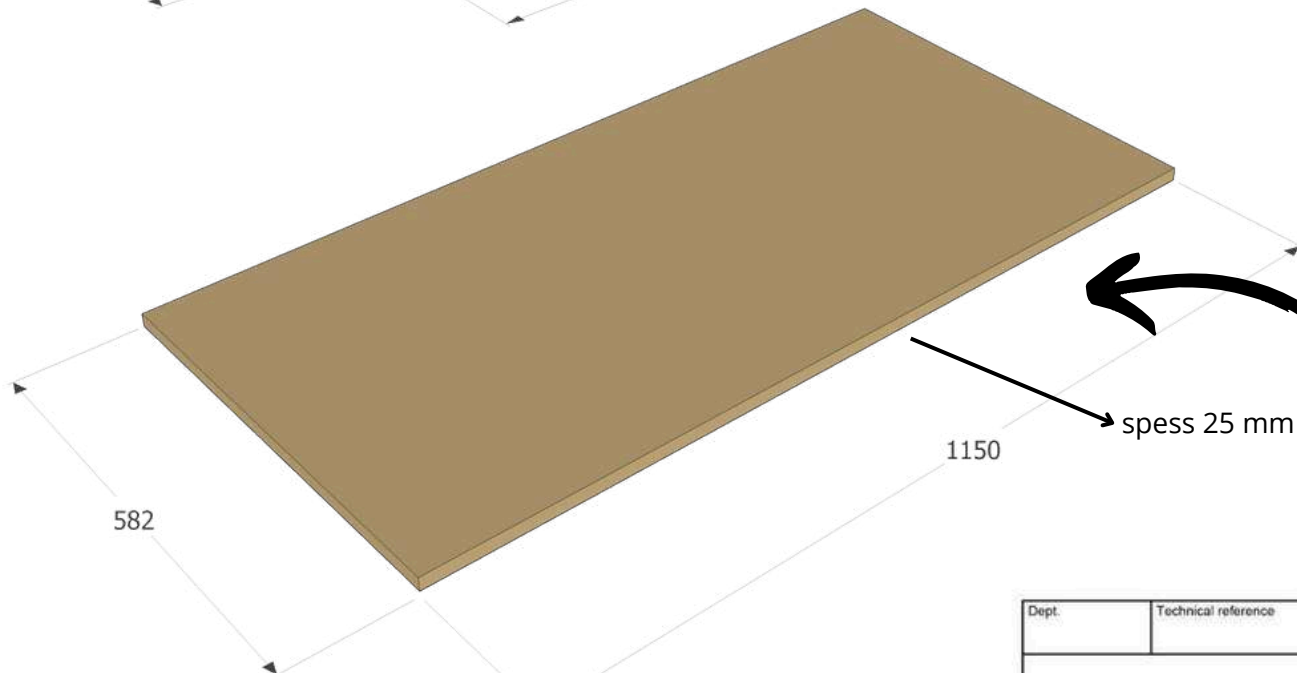
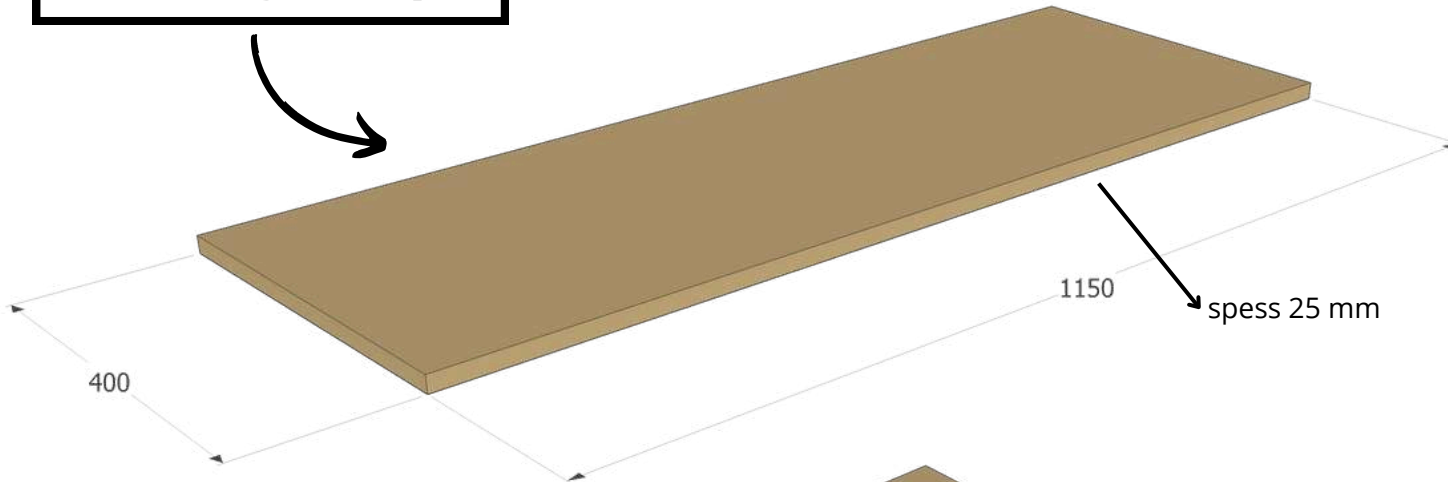
**Prolunga - 1 pz**



**Ripiani - 3 pz**

Dept.	Technical reference	Created by	21-09-2024	Approved by
 		Document type	Document status	
		Title	Cabina di verniciatura	
Rev.	Date of issue	Sheet		

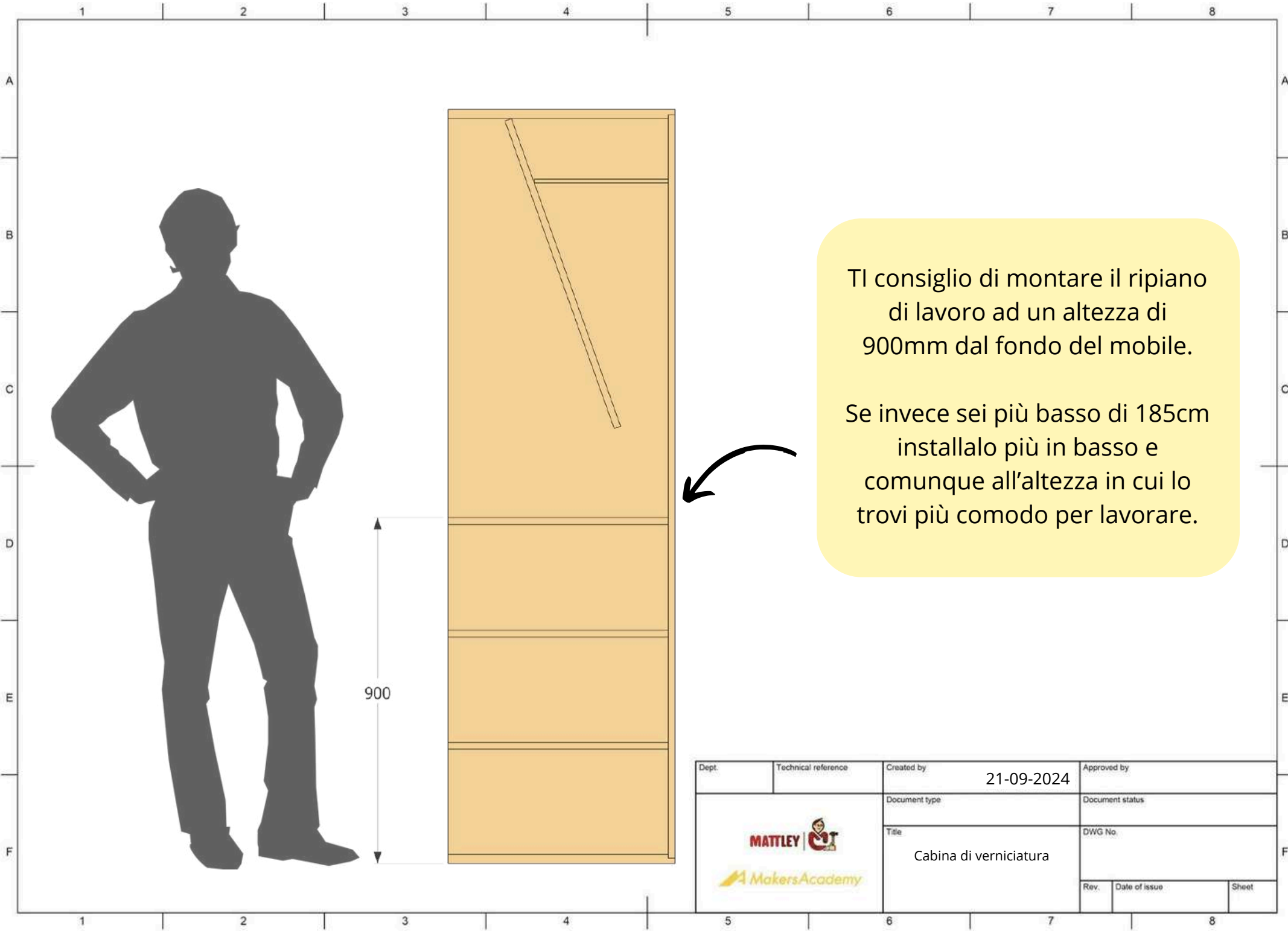



Ti consiglio di montare il ripiano di lavoro ad un altezza di 900mm dal fondo del mobile.

Se invece sei più basso di 185cm installalo più in basso e comunque all'altezza in cui lo trovi più comodo per lavorare.



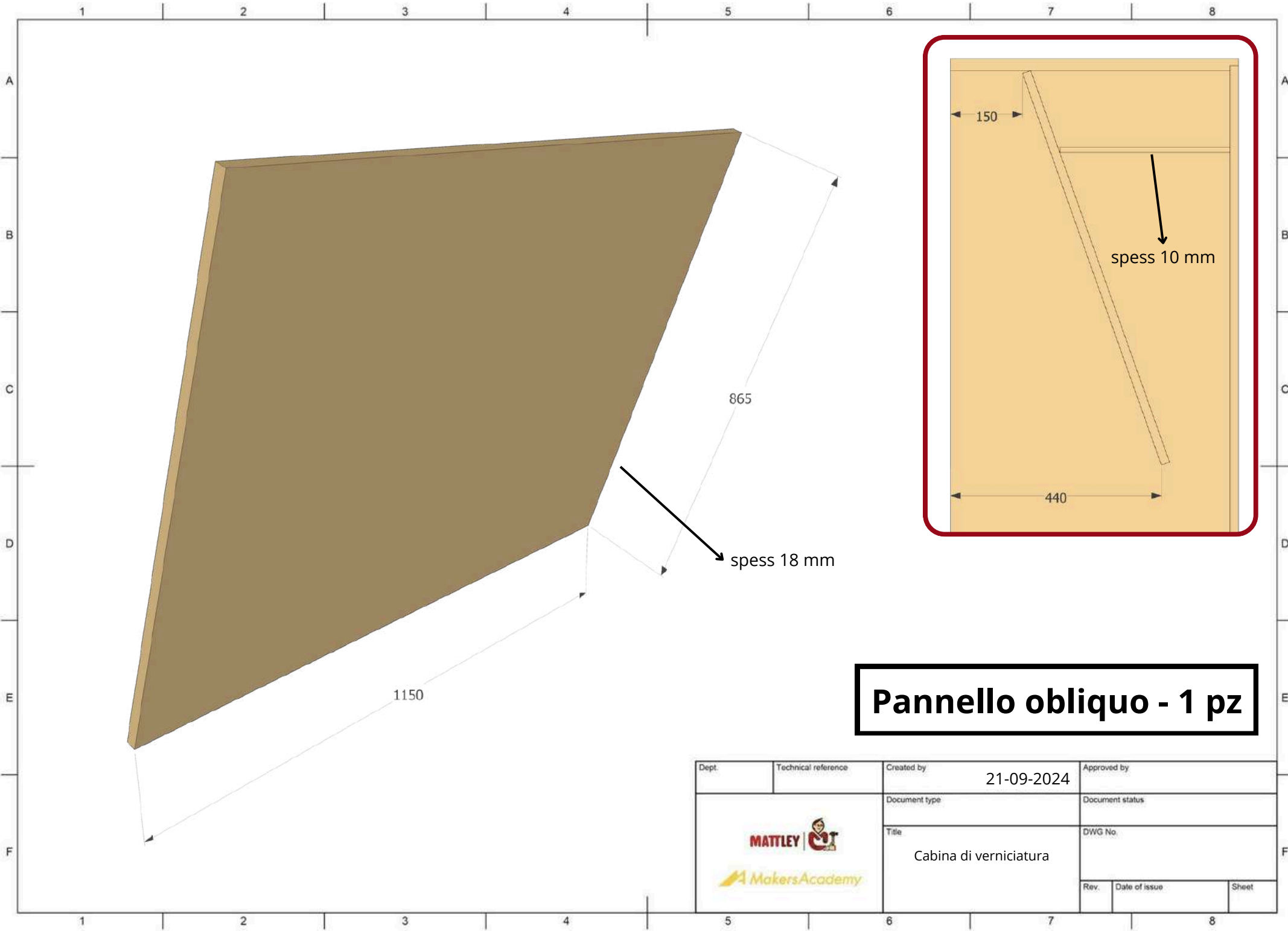

900

Dept.	Technical reference	Created by	21-09-2024	Approved by
 		Document type	Document status	
		Title	DWG No.	
		Cabina di verniciatura		
Rev.	Date of issue	Sheet		



**Pannello obliquo - 1 pz**

Dept.	Technical reference	Created by	21-09-2024	Approved by
 		Document type	Document status	
		Title	DWG No.	
		Cabina di verniciatura		
Rev.	Date of issue	Sheet		